



Techno Vector 7

computer-based **3D** wheel aligners



*Precision
in Motion*





Techno Vector 7 – 3D computer-based wheel alignment systems

Wheel aligners include a **machine vision system** which consists of 4 or 2 video camera units located in a special housing which is installed in front of the car, and high-precision image targets

4 HD digital video cameras (one for each wheel) recognize the position of the high-precision image targets in space



The ultimate innovation in wheel alignment



The operation of the wheel aligners is based on measurements of wheel axis angle parameters by video cameras and high-precision image targets

Integrated storage for targets and wheel adapters on the computer cabinet

Moving wheel adapter along with target easily at the same time

Mounting wheel adapter and target easily at the same time

Rolling compensation

Techno Vector 7 is designed to check and perform wheel alignments on vehicles with 12 to 24" disks

32" monitor is an additional option and is designed to duplicate the desktop of the main monitor (to make the adjustment screen more visible) and to expand the desktop (to place more advertising materials of your car shop)



WideScope®

The WideScope technology makes it possible to increase the range of working heights of the lift up to twice as much as similar wheel aligners of other companies

(See pages 6-7 for details)



Machine Vision System



Video cameras

HD cameras allow a quick and reliable target "capture" and a high-speed image transfer to the PC over TCP/IP

Special software promotes high-precision recognition of targets in space on the basis of received images



The use of 3D technologies allows high-precision measurements

Special camera firmware promotes a high speed screen refresh

Targets

Compact and easy targets

One target for each wheel

Easy to handle

The front panel is protected with a rubberized border

No electronic components

No need to calibrate targets



Targets (set) №1

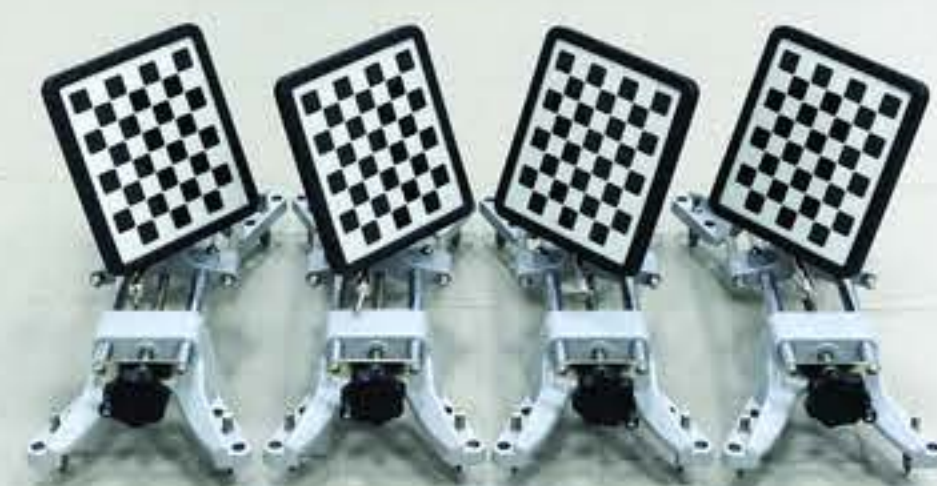

Targets (set) №2

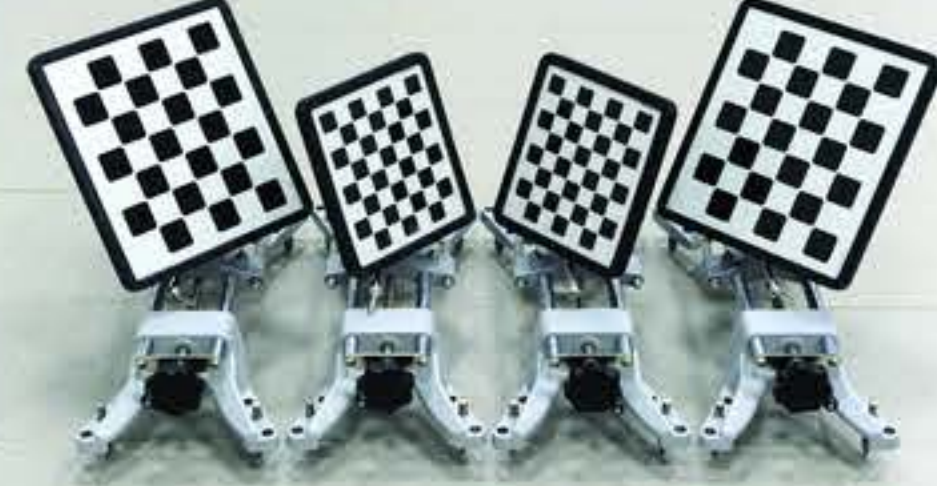

Wheel Adapters

Self-centering wheel adapters with the mobile central part fit 12" -24" wheel disks and are compatible with motorcars and trucks

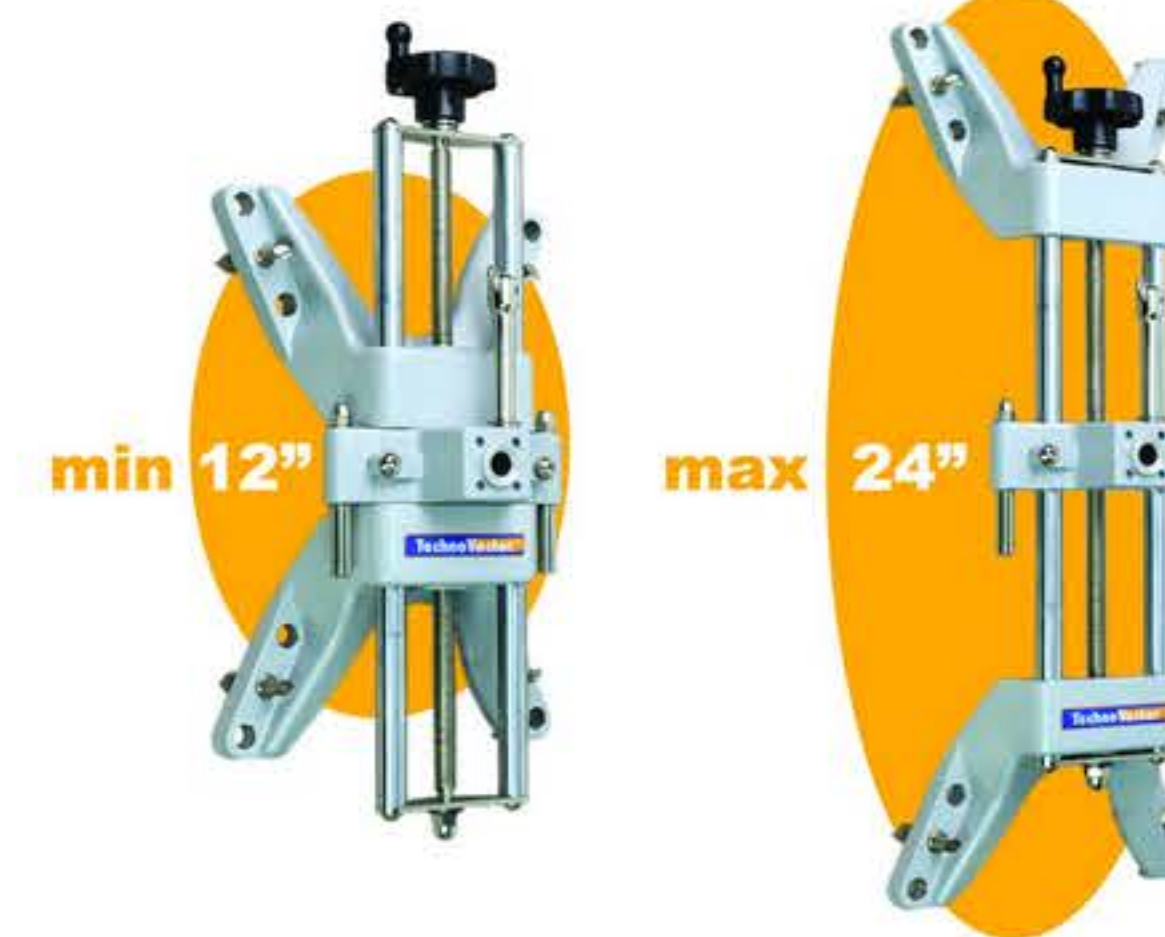

Operation



Clamps arms can be adjusted easily to various disk diameters with a special handle



Quick and reliable target mounting in wheel adapters with a shaft lock



The change from the minimum disk size to the maximum disk size is made by interchanging "claws"

Adapters



Double "claws" allow operating steel and light-alloy disks





Wide-angle machine vision system



WideScope - "wide-angle" technology

Key features of the Wide Scope technology:

The range of working heights of the lift is up to twice as much as similar wheel aligners of other companies.

The 4-camera wheel aligner allows to take measurements and perform alignments on the lift from the alignment height (1700 mm) to the floor level* without using any camera displacement mechanisms, stairs and stands.

The 2-camera wheel aligner allows to take measurements and perform alignments on the lift in the range of lift heights of 900 to 1700* mm from the floor level.

Minimum distance (from 1200 mm) from camera units to the lift or pit in comparison to similar wheel aligners of other manufacturers.

Minimum requirements for service station size – from 6550 mm.

Long-range capability – video camera housings can be installed at a long distance.

It is especially important for wall-mount configurations when the wall is far from the workplace (3-4 meters).

Operation can be carried out even when the target image is partially closed or damaged!

* it depends on the distance of the camera housing installation

4-camera wheel alignment system has a full view of the lift heights from the alignment height to the floor without using any displacement mechanisms for the cameras.

WideScope®

2-camera wheel alignment system

with capabilities of a

4-camera wheel alignment system.

Camera vision range diagrams for the Wide Scope Techno Vector 7 wheel aligners

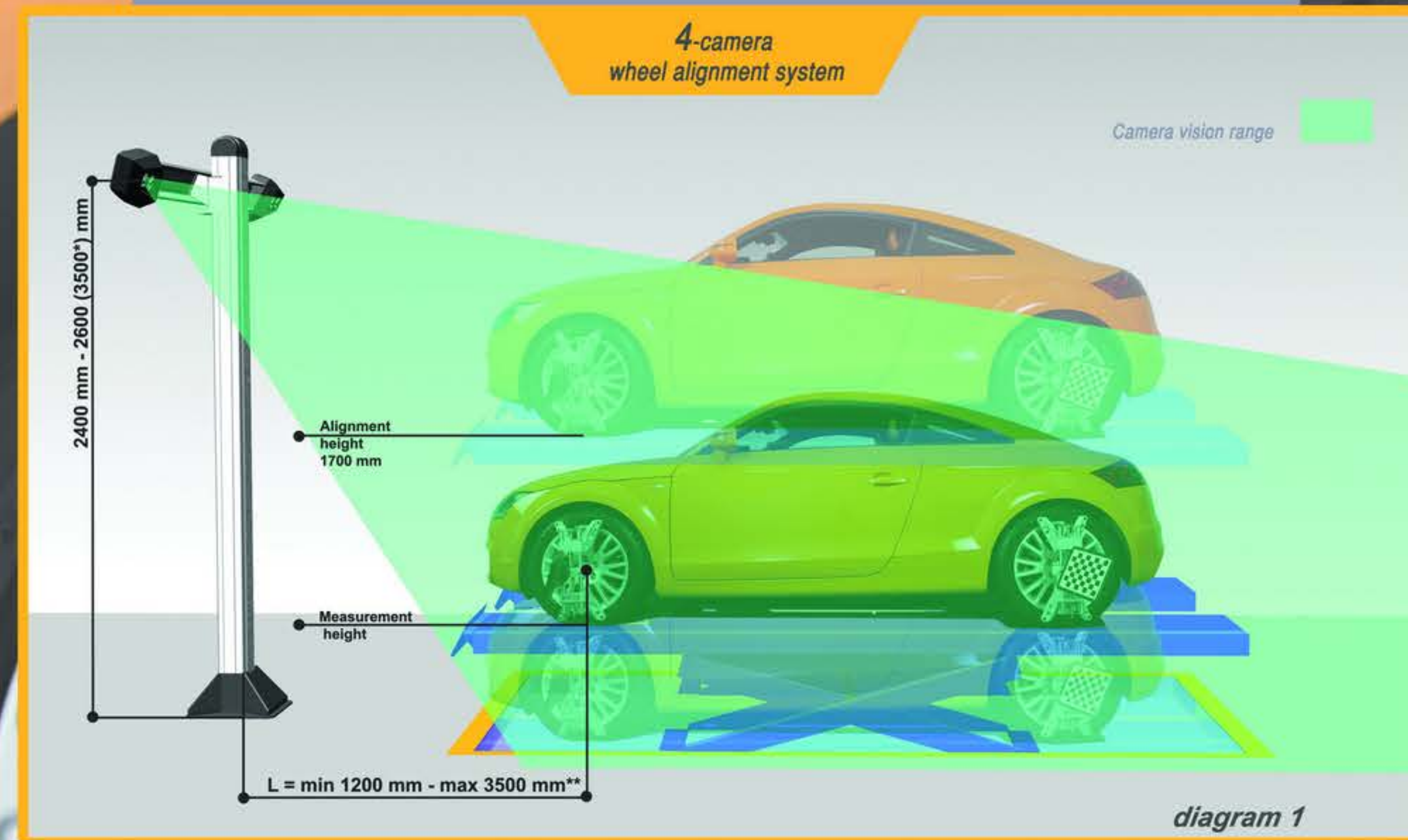

* - for wall-mount configuration (type K).
 ** - camera characteristics differ for 1200-2550mm range and 2550-3500 mm range, if the distance is more than 2550, the measurement height increases.

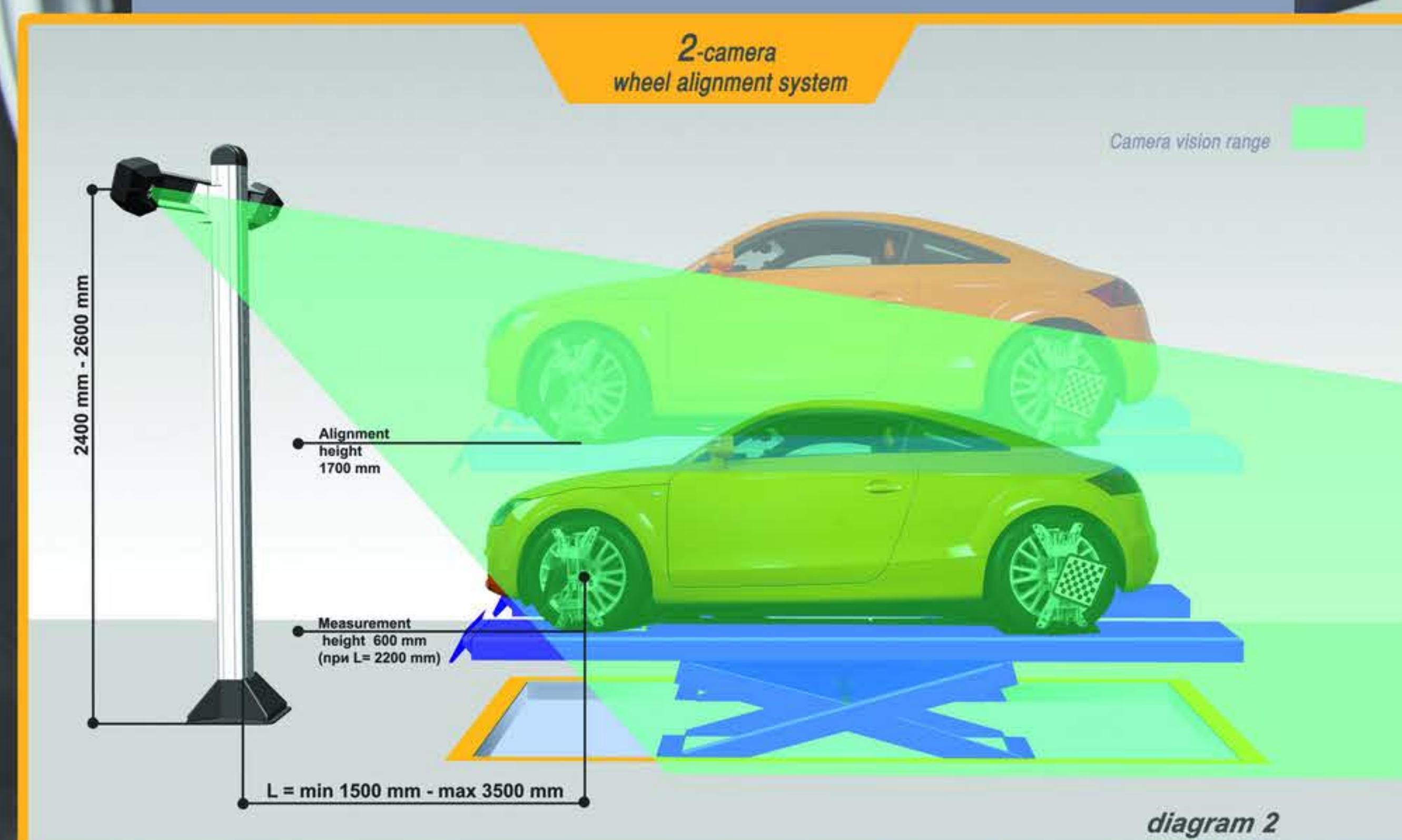



Computer Cabinets

Computer cabinet includes:

- electronic unit based on PC with Intel Core I3 processor and up-to-date video card that supports Direct X11
- 22" and above widescreen LCD monitor
- special bracket
- printer
- wireless remote control
- brackets for integrated storage of wheel adapters and targets

V-series



T-series



Light-series



Specifications

Parameter	Techno Vector 7		
	Measurement Range	Maximum Error in Measurement	Average Error in Measurement
Front Wheel Alignment			
Camber	±8°	±3'	±2'
Front Total Toe	±5°	±3'	±2'
Caster	±19°	±8'	±5'
SAI / KPI	±19°	±8'	±5'
Lock Angle	±45°	±10'	±5'
Rear Wheel Alignment			
Camber	±8°	±3'	±2'
Rear Total Toe	±5°	±3'	±2'
Rear Individual Toe	±2,5°	±3'	±2'
Symmetry Angles			
Front Set Back	±2,5°	±3'	±2'
Rear Set Back	±2,5°	±3'	±2'
Thrust Angle	±2,5°	±3'	±2'
Geometrical Driving Axis	±2,5°	±3'	±2'

Parameter	Value
Voltage, W	220 ± 10%
Frequency, Hz	50/60
Wheel Adapter (Clamp) Mounting Range, in.	12 ÷ 24
Operating Temperature, C	+10 ÷ +35
Power Consumption	350
Net Weight, kg	280
Gross Weight, kg	390
Volume	1,7
Number of Packages	7
Climatic Category of the Device according to GOST (All-Union State Standard)	GOST 15150-69



Universal telescopic monitor bracket



It allows to adjust the LCD monitor position (height and inclination angle) to provide maximum visibility and operability.

Delivery Set

Techno Vector 7 (Standard accessories)	Quantity, pcs.
1. Machine Vision System	1
2. Computer Console	1
3. Electronic Unit	1
4. Target Set	4
5. Self-Centering Wheel Adapter (Clamp)	4
6. Steering Wheel Holder	1
7. Brake Lock	1
8. Turnplate	2
9. Remote Control Receiver	1
10. Remote Control	1
11. Manual	1



Turnplates (set)



Electronic unit

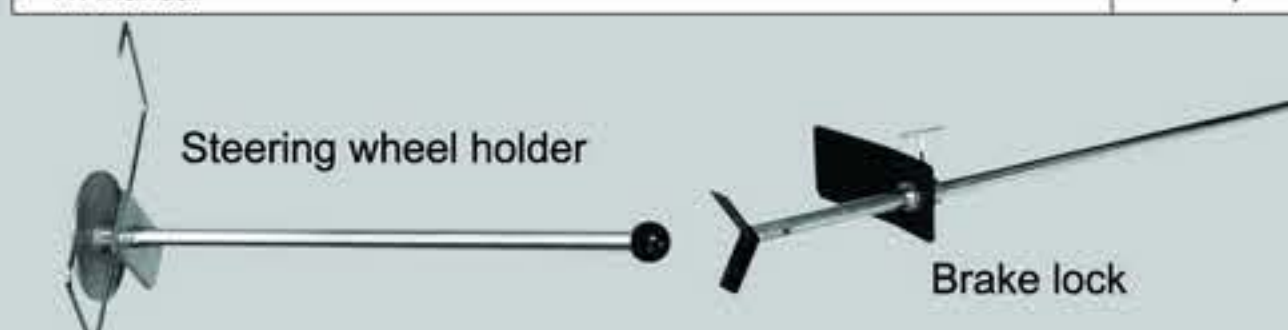

Steering wheel holder

Brake lock

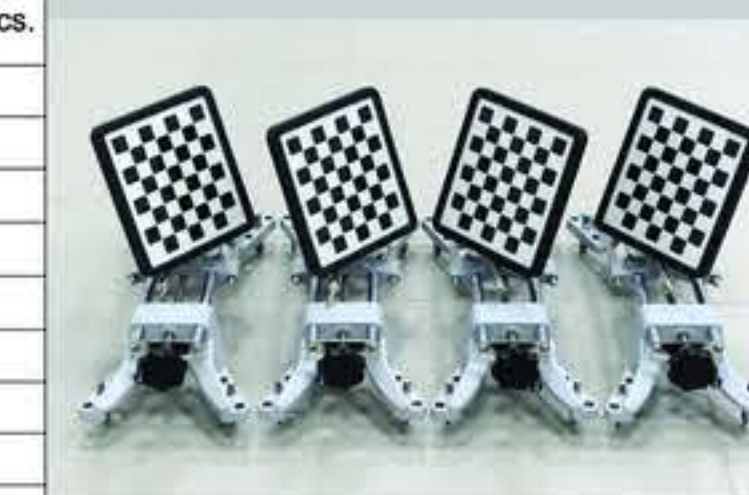

Wheel adapter (set)



Remote control



A high-tech remote control V-series allows a quick access to all Techno Vector program modes



A tip-up panel provides a direct access to system unit ports

TechnoVector

Sliding shelf for keyboard (to enter client data)

Control panel V-series

Drawer for keyboard and printer





Techno Vector Software



Database Image View



Target Setup

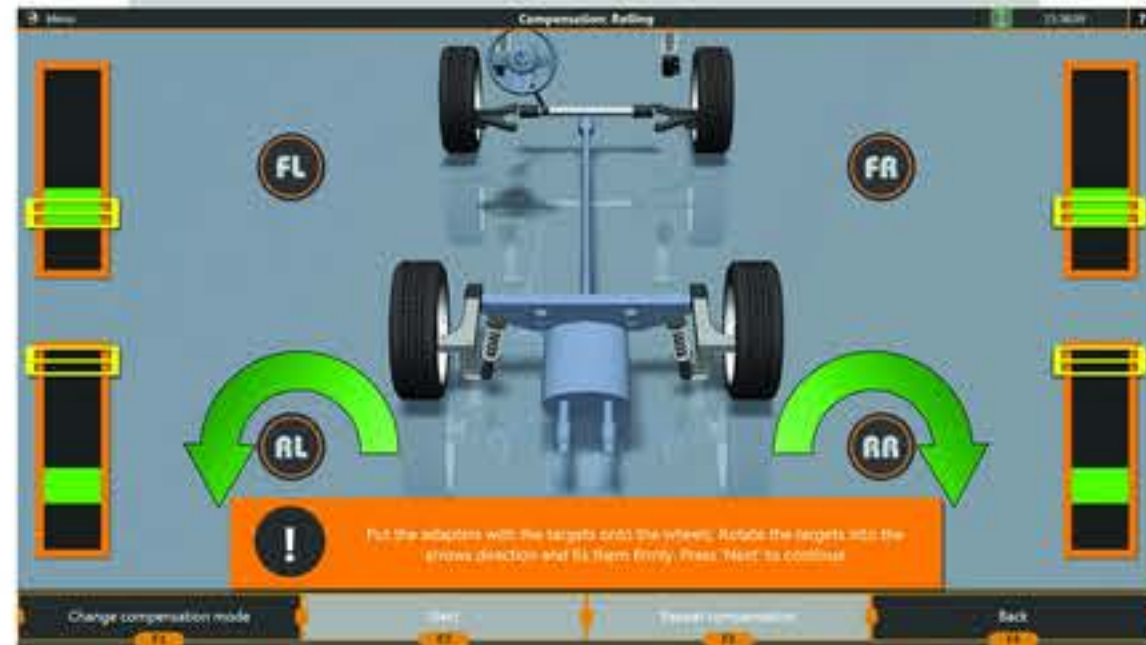

Rolling Compensation Mode

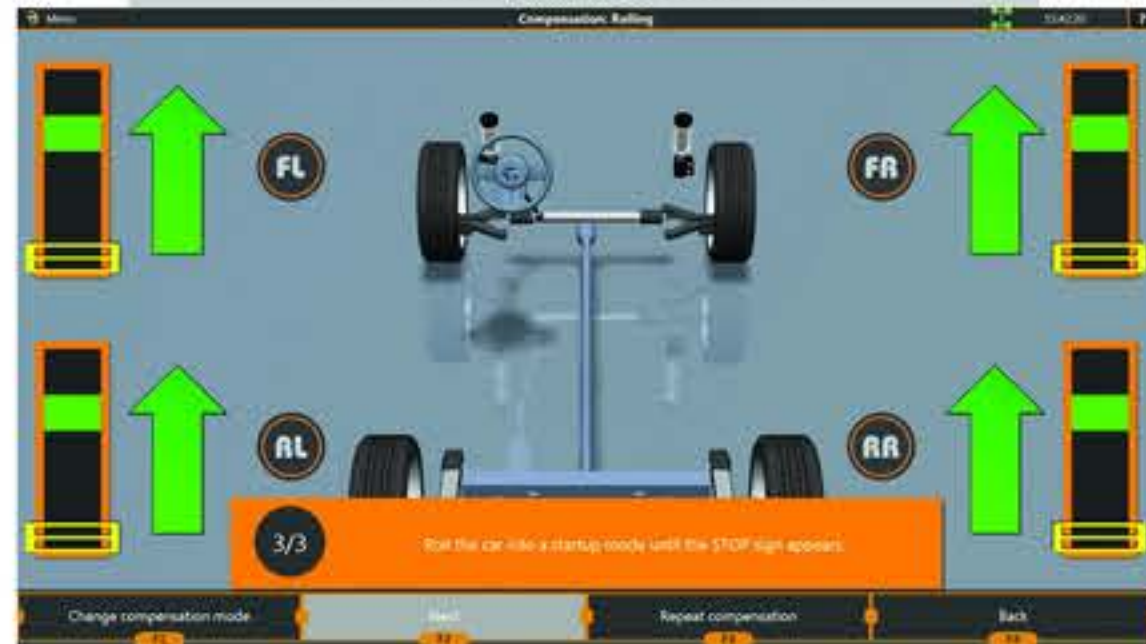

The Techno Vector 7 software is a powerful and modern device for checking and controlling wheel alignments.

Continuous data processing and measurement displaying.

Easy operating away from the monitor with color indicators.



Automatic parameter assessment of compliance with specifications.

Quick access to other program modes



The Techno Vector 7 software based on PC works with **Windows 7**

Measurement Mode



3D Adjustment Mode



3D visualization, 7 modes

2D Adjustment Mode



2D visualization, 2 modes

Report View

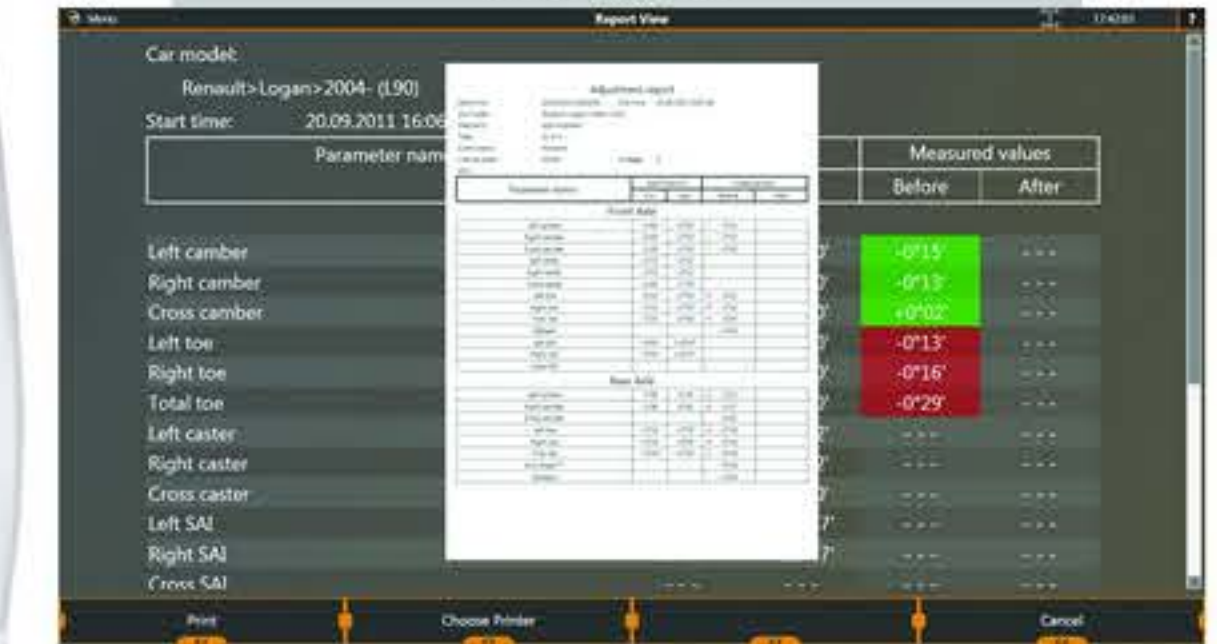

Database

- The database integrated in the program includes:
- wheel alignment specifications
 - tire pressure specifications
 - 3D animation
 - adjustment diagrams and images
 - **data for more than 40 000 vehicles.**

Help System

- The electronic Help system contains thorough information on working with the wheel alignment machine and program:
- video for working with the equipment
 - video lectures on working with the program
 - information on adjustments - diagrams, images, video, 3D animation



asanetwork

The wheel alignment system software supports **ASA Network** (communication standard for service centers and dealer centers). It allows to take orders centrally and send measurements to vehicle receiving centers.



Remote control V-series



Free annual software updates

3D Animation





Configurations

Different types of housing configurations are designed for the optimum arrangement of machine vision cameras in different shops

T-type

Premium



It is a floor-mount version of a wheel aligner. Measurements and alignments are performed on a lift*.

Aluminum

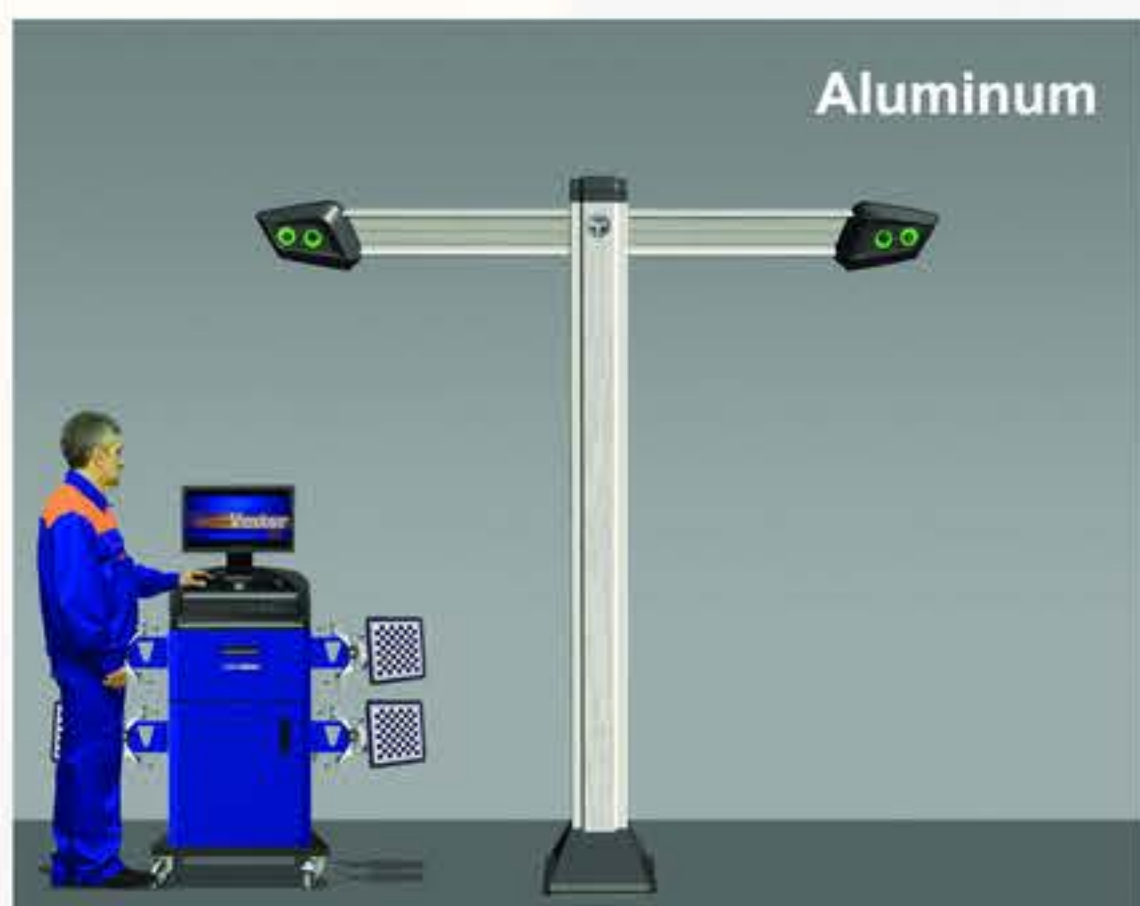

Steel

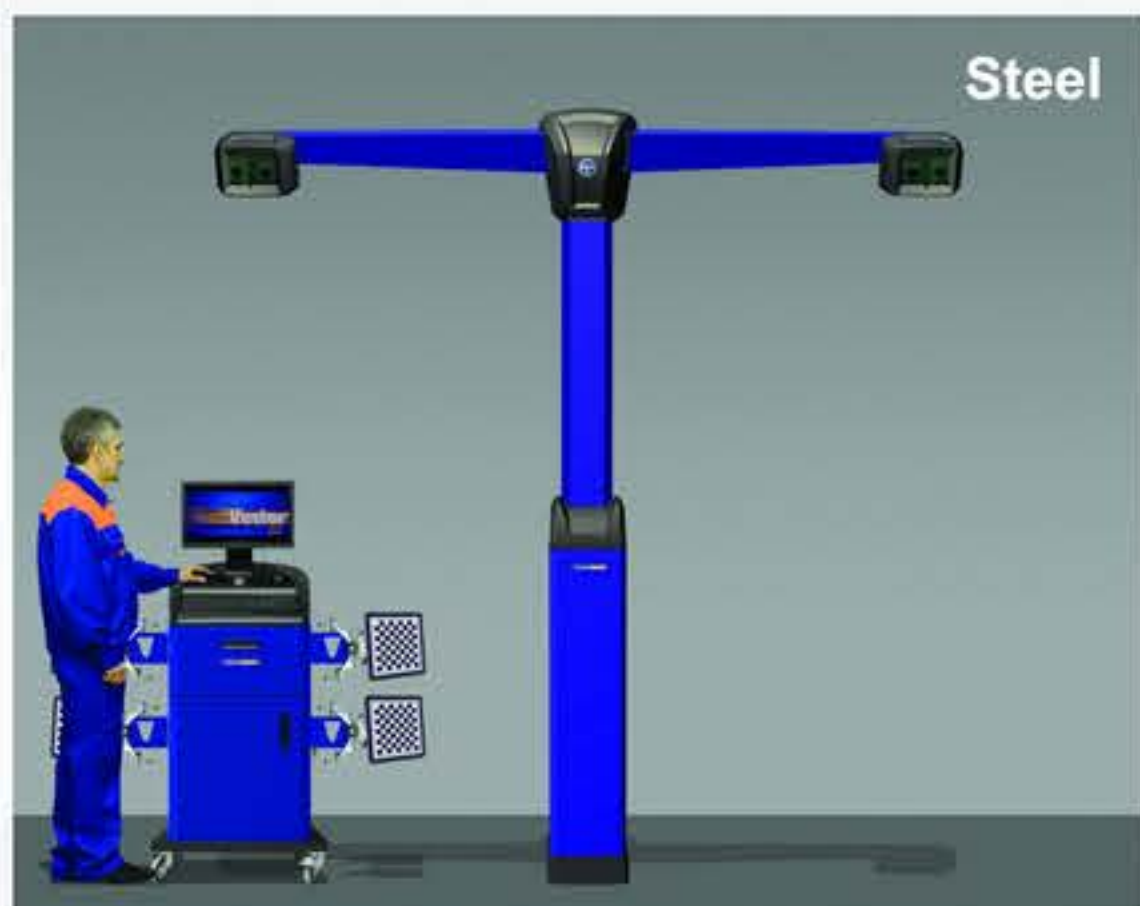

4-camera wheel aligners



K-type

Aluminum

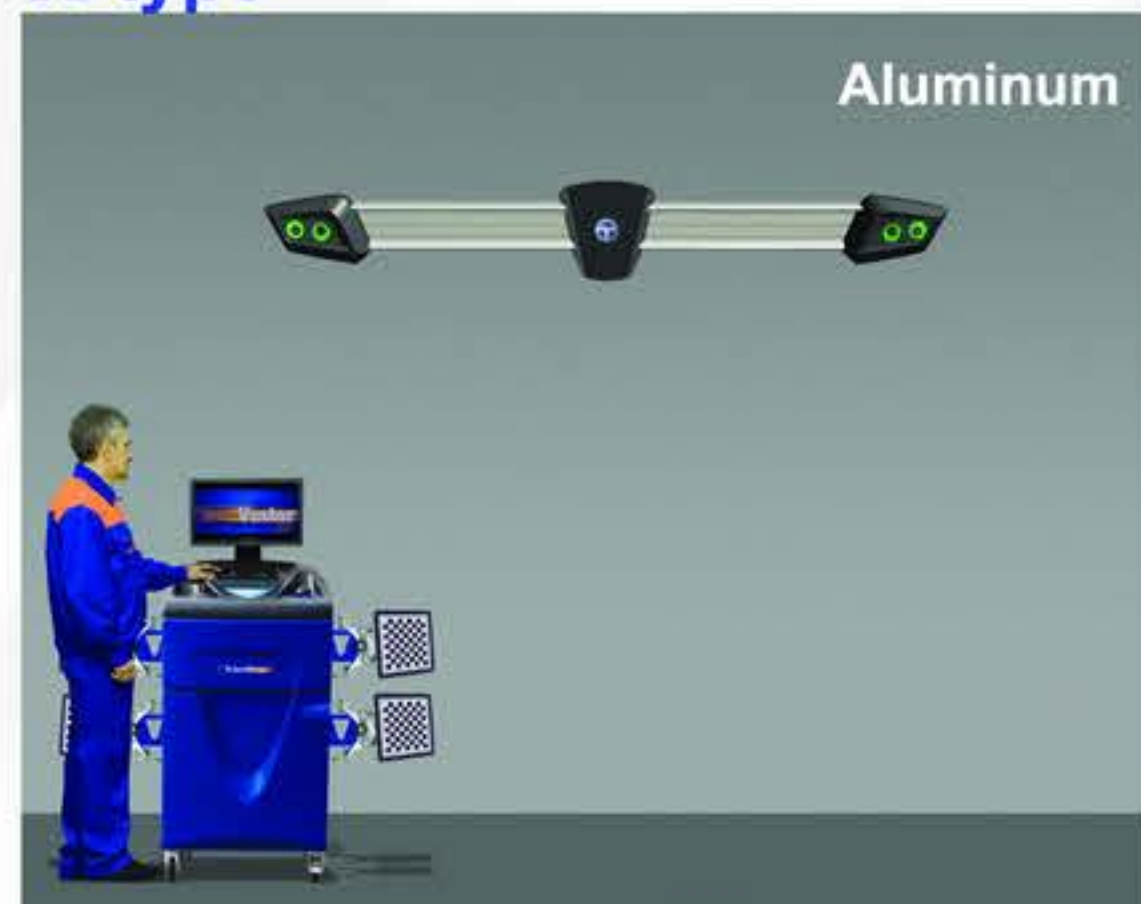

It is a wall-mount version of a wheel aligner. Measurements and alignments are performed on a lift* or pit.

H-type

Aluminum



It is a floor-mount version of a wheel aligner. Measurements and alignments are performed on a lift. Drive-through is allowed.

*see diagram 1 on page 7

*Up-to-date
wheel aligners
for modern car shops*

T-type

Aluminum



It is a floor-mount version of a wheel aligner. Measurements and alignments are performed on a lift**.

M-type

Aluminum



It is a floor-mount version of a wheel aligner. Measurements and alignments are performed over a pit. Drive-through is allowed.

2-camera wheel aligners



K-type

Aluminum



It is a wall-mount version of a wheel aligner. Measurements and alignments are performed on a lift** or pit.

** see diagram 2 on page 7

In the picture you can see a 4-camera wheel aligner Techno Vector 7 Aluminum T-type with an additional option (32" wide-angle flat monitor)



Initial installation of the device

The initial installation of the equipment is performed by the manufacturer's service technicians. The device works with a 4 post wheel alignment lift or a repair pit, compliance with the horizontality requirements is strongly recommended.



Certificates



Pattern Approval Certificate of Measuring Instruments RUC.28.001.A № 51081



Pattern Approval Certificate of Measuring Instruments RUC.27.001.A № 38858



Certificate of Conformance № 6651



Certificate of Conformance № C-RU.AF83.B.09992



Certificate of Conformance № C-RU.AF83.B.09993

The awarding ceremony of the contest 100 Best Commodities of Russia 2010 took place in 2010 as a part of activities devoted to European Quality Week and World Quality Day



As a result of the contest the Techno Vector 7 wheel alignment gauge got the Gold Award and the Novelty of 2010 Certificate

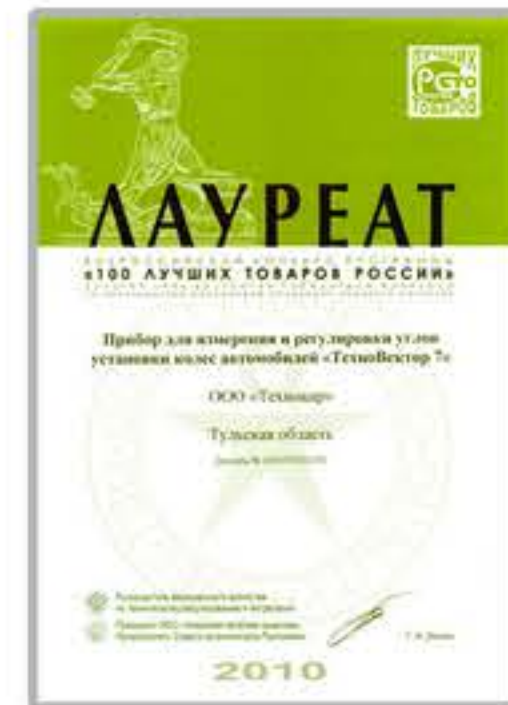

The Gold Award is given to the winner of the contest for manufacturing high-quality Russian products



The Certificate is given to the participant of the contest for manufacturing new high-quality products



Marking

V 7 2 0 4 T 5 A D
1 2 3 4 5 6 7 8 9

- 1 Letter symbol of a computer console series: T, V.
- 2 Numeric symbol of a device series according to the type of measuring: 7-measuring by video cameras and high-precision image targets (3D).
- 3 Numeric symbol of axis number measured simultaneously.
- 4 Numeric symbol of a video camera type: 0 - stationary, 1 - movable
- 5 Numeric symbol of the total number of video camera units in the modification.
- 6 Letter symbol of a video camera housing type T, H, M, K.
- 7 Symbol of maximum resolution for video cameras: 1 (1.3Mp), 5 (5Mp)
- 8 Letter symbol of video camera housing: Premium, Aluminum, Steel
- 9 D is a symbol for beam inclination drive



Techno Vector

*Precision
in Motion*

