



**SØRENSEN & KOFOED A/S**

*Alt i teknisk gummi, slanger & hydraulik. Supplier of Technical Rubber, Hoses and Hydraulics*

# LØFTEUDSTYR





# SØRENSEN & KOFOED A/S

Alt i teknisk gummi, slanger og hydraulik. Supplier of Technical Rubber, Hoses and Hydraulics

**Sørensen & Kofoed A/S** blev grundlagt i 1960 som gummi- og slangegrossist.

Gennem årene har vi ekspanderet og har i dag 50 medarbejdere og 9 selvstændige forretningsområder:

Udover løfteudstyr leverer Sørensen & Kofoed A/S løsninger inden for:

**Hydraulik**  
**Industrislanger og -koblinger**  
**Teknisk gummi**  
**Tætninger**  
**Transmissioner**  
**Energikæder**  
**Højtrykspakninger**  
**Kabelbeskyttelse**

Du kan se meget mere på vores hjemmeside [www.skdk.dk](http://www.skdk.dk)

Sørensen & Kofoed A/S er sammen med Linatex A/S og BS Specialslanger A/S en del af S&K Group A/S der er en 100% dansk ejet familie virksomhed.



**S&K GROUP A/S**



# SIKKERHED

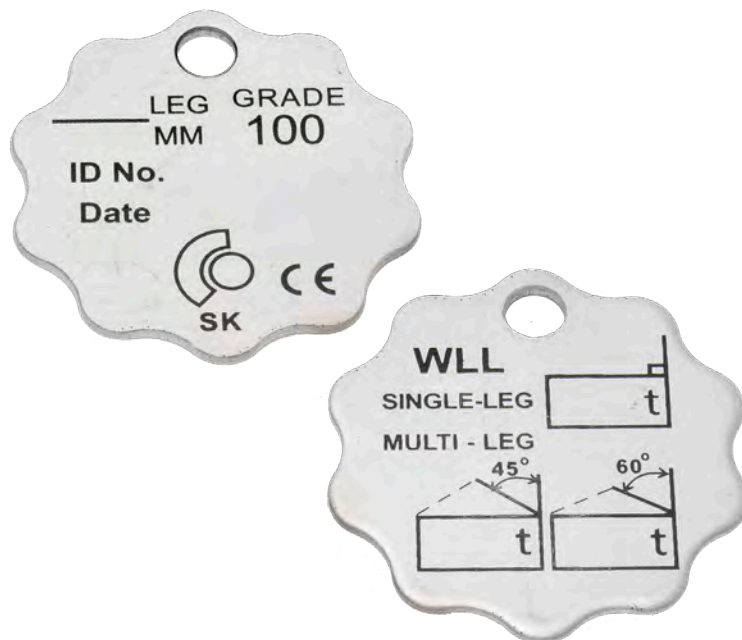

## SIKKERHED VEDR. DERES VIRKSOMHED

Arbejdstilsynet lovbefaler at løfte- og anhugningsgrej skal kontrolleres af en sagkyndig person, en gang årligt i henhold til arbejdstilsynets bekendtgørelse nr. 1109, om anvendelse af tekniske hjælpemidler § 8 og § 14 samt arbejdsmiljøloven § 45.

Med en sagkyndig person, menes en person i jeres virksomhed der har gennemgået et kursus i løfte- og anhugningsgrej. Dette kursus kan bestilles hos Sørensen & Kofoed A/S. Efter endt kursus modtages et kursusbevis, der kan fremvises for arbejdstilsynet.

## KONTROL AF KÆDER OG TILBEHØR

Kæder og tilbehør kontrolleres for revner og slidtage. Kæder må max vise en forlængelse på 5 % målt over 5 led, ligesom den maximale tilladte slidtage er 10 % af den oprindelige dimension.

## LØFTEÅG, UDLÆGGERE O. LIGN.

Kontrolleres for revner samt synlige deformationer.

## LØFTEBÅND OG RUNDSLING

Kontrolleres visuelt for slid og snitskader, ligesom mærkningen kontrolleres.

## EFTERSYN

Ved eftersyn af kædesling udskiftes og opmærkes mærkebrikken med korrekt belastning samt dato og initialer af vedkommende som har udført eftersynet. Rundsling og båndstropper mærkes således at arbejdstilsynet kan se at de er eftersat.

## LØBENDE VEDLIGEHOLDELSE

Kæder skal straks tages ud af drift, hvis brugeren eller et kontrolorgan iagttager, at kæden eller tilhørsdele ikke længere er fuld funktionsdygtige.

Kæder, rundsling, båndstropper og andre dele skal kartoteksføres så det kan bruges som dokumentation overfor arbejdstilsynet og andre tilsynsførende myndigheder.

## KEMIKALIER

Kæder i klasse 8 må ikke komme i kontakt med syre og andre kemikalier, ej heller må de udsættes for varmforzinkning.



# RUNDSLING

## Belastningstabel

Arbejdsbelastning i kg									
Farve Varenr.	Lige løft kg	Snøret løft kg	U-løft kg	U-løft kg		2-parts løft kg		3 og 4 parts løft kg	
	100%	80%	200%	140%	100%	140%	100%	150%	210%
				45°	60°	45°	60°	45°	60°
540R01...	1000	800	200	1400	1000	1400	1000	2100	1500
540R02...	2000	1600	4000	2800	2000	2800	2000	4200	3000
540R03...	3000	2400	6000	4200	3000	4200	3000	6300	4500
540R04...	4000	3200	8000	5600	4000	5600	4000	8400	6000
540R05...	5000	4000	10000	7000	5000	7000	5000	10500	7500
540R06...	6000	4800	12000	8400	6000	8400	6000	12600	9000
540R08...	8000	6400	16000	11200	8000	11200	8000	16800	12000
540R010...	10000	8000	20000	14000	10000	14000	10000	21000	15000

Sikkerhedsfaktor 7:1

## RUNDSLING SORTIMENT



"Lille" nr. 540RS020 med 20 små rundsling

540R0101	1 ton	1 meter	2 stk
540R0102	1 ton	2 meter	2 stk
540R0103	1 ton	3 meter	2 stk
540R0202	2 ton	2 meter	4 stk
540R0204	2 ton	4 meter	4 stk
540R0206	2 ton	6 meter	2 stk
540R0208	2 ton	8 meter	2 stk
540R0306	3 ton	6 meter	2 stk

"Stor" nr. 540RSS020 med 20 store rundsling

540R0202	2 ton	2 meter	2 stk
540R0204	2 ton	4 meter	2 stk
540R0206	2 ton	6 meter	2 stk
540R0304	3 ton	4 meter	4 stk
540R0306	3 ton	6 meter	2 stk
540R0504	5 ton	4 meter	4 stk
540R0508	5 ton	8 meter	4 stk





# BÅNDSTROPPER

## Belastningstabel

Arbejdsbelastning i kg						
Farve Varenr.	Lige løft kg	Snøret løft kg	U-løft kg	U-løft kg	U-løft kg	U-løft kg
				45°	90°	120°
540B01...	1000	800	2000	1800	1400	1000
540B02...	2000	1600	4000	3600	2800	2000
540B03...	3000	2400	6000	5400	4200	3000
540B04...	4000	3200	8000	7200	5600	4000
540B05...	5000	4000	10000	9000	7000	5000
540B06...	6000	4800	12000	10800	8400	6000
540B08...	8000	6400	16000	14400	11200	8000
540B010...	10000	8000	20000	18000	14000	10000
540B012...	12000	9600	24000	21600	16800	12000

Sikkerhedsfaktor 7:1

## BÅNDSTROP SORTIMENT

"Lille" nr. 540BS020 med 20 små båndstroppe

540B0101	1 Ton	1 meter	2 stk
540B0102	1 Ton	2 meter	4 stk
540B0103	1 Ton	3 meter	2 stk
540B0202	2 Ton	2 meter	2 stk
540B0204	2 Ton	4 meter	4 stk
540B0206	2 Ton	6 meter	2 stk
540B0304	3 Ton	4 meter	2 stk
540B0306	3 Ton	6 meter	2 stk

"Stor" nr. 540BSS020 med 20 store båndstroppe

540B0202	2 Ton	2 meter	2 stk
540B0204	2 Ton	4 meter	2 stk
540B0206	2 Ton	6 meter	2 stk
540B0304	3 Ton	4 meter	4 stk
540B0306	3 Ton	6 meter	4 stk
540B0504	5 Ton	4 meter	2 stk
540B0508	5 Ton	8 meter	4 stk

# BUGSERSTROP



Varenummer	Længde	Max.
540BU0806	6 meter	8 ton
540BU1806	6 meter	18 ton
540BU2406	6 meter	24 ton
540BU3606	6 meter	36 ton
540BU4806	6 meter	48 ton
540BU6006	6 meter	60 ton

# ENDELØSE SURRINGER

Endeløse surringer, sortiment á 42 styk

Vare nummer: 541-Sorti25-40				
Farve	Brudstyrke	Bredde	Længde	Antal
Sort bånd	100 kg	18 mm	1,5 m	10 styk
Gult bånd	250 kg	25 mm	1,5 m	8 styk
Rødt bånd	250 kg	25 mm	2,0 m	8 styk
Blåt bånd	250 kg	25 mm	2,5 m	8 styk
Orange bånd	250 kg	25 mm	3,5 m	8 styk



## 5T ERGO TYPE SURRINGER

Varenummer	Bredde	Længde	Max.
541-ILS5TB10ERGO	50 mm	0,5 +9,5 meter	5.000 kg



# SURRINGER



Type	Brudstyrke	Bredde	Længde
541-ILS25A05	500 kg	25 mm	0,4/4,6 meter med kroge og spænde
541-ILS25A05U	500 kg	25 mm	5,0 meter uden kroge, med spænde
541-ILS35A05	2500 kg	35 mm	0,5/4,5 meter med kroge og spænde
541-ILS35A05U	2500 kg	35 mm	5,0 meter uden kroge, med spænde
541-ILS50E10	4000 kg	50 mm	0,5/9,5 meter med kroge og spænde
541-ILS5TB10	5000 kg	50 mm	0,5/9,5 meter med kroge og spænde
541-ILS75E035	10000 kg	75 mm	0,5/3,0 meter med kroge og spænde

# AUTOTRANSPORTSURRINGER



## Dobbel hjulsurring

Varenummer	Bredde	Længde	Max.
541A09999	Sæt bestående af de to nedestående		
541A08090	50 mm	0,5 meter	4000 kg
541ILS50E10	50 mm	9,5 meter	4000 kg



## Enkel hjulsurring

Varenummer	Bredde	Længde	Max.
541A05036	35 mm	2 meter	2500 kg
541A10036	50 mm	3 meter	4000 kg

# HÅNDKÆDEDETALJER



## BESKRIVELSE

Kapacitet 0,5-2T | Meget brugervenlig, let at håndtere | 3 mtr. løftehøjde  
Klasse 8 lastkæde | Mærket med løfteevne og serienummer

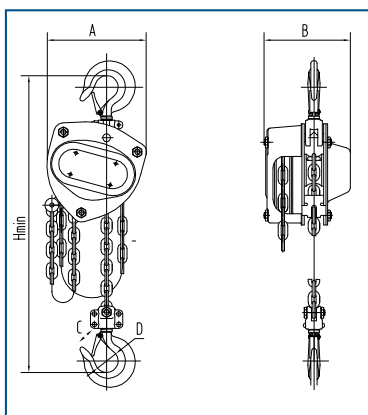

Varenummer	Ton WLL	Løftehøjde MTR.	Prøvelast KN	Kæde dim. MM.
545-CH050	0,50	3	7,5	5
545-CH100	1,00	3	15	6
545-CH200	2,00	3	30	8

A mm	B mm	C mm	D mm	K mm	VÆGT kg
132	148	345	35	23	11
151	172	376	40	27	12,5
175	210	470	50	35	19,5



# SKRALDETALJER



## BESKRIVELSE

Kapacitet 0,25-3T | Lastkrog med sikkerhedspal | Meget brugervenlig, let at håndtere  
1,5 / 3 mtr. løftehøjde | Klasse 8 lastkæde | Mærket med løfteevne og serienummer

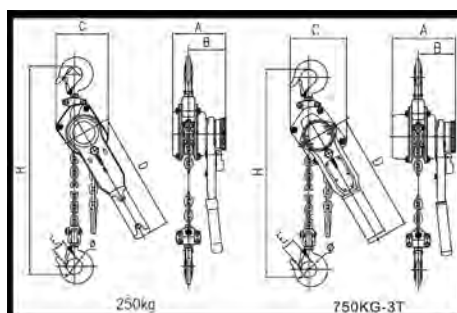

Vare nr.	Ton WLL	Løftehøjde	Prøvelast KN	Kæde dim. mm.	A mm.	B mm.	C mm.	D mm.	K mm.	VÆGT kg.
545-CK025	0.25	3	3.70	4x12	92	71	70	31	20	2.3
545-CK050	0.50	3	7.50	5x15	143	86	118	31.5	24	5.5
545-CK075	0.75	3	11.25	6x18	148	87	132	35.5	27	6.9
545-CK150	1.50	3	22.00	7x21	173	99	145	42.5	33.5	10.9
545-CK300	3.00	3	45.00	10x30	200	112	199	50	40	20.7

# RESERVEDELE TIL TALJER



Varenummer	Tekst
545-CHK050	Kæde for håndkædetalje 545-CH050
545-CHK100	Kæde for håndkædetalje 545-CH100
545-CHK200	Kæde for håndkædetalje 545-CH200

Varenummer	Tekst
545-CHP050	Rep. set for kroge håndkædetalje - 500kg.
545-CHP100	Rep. set for kroge håndkædetalje - 1000kg.
545-CHP200	Rep. set for kroge håndkædetalje - 2000kg.

Varenummer	Tekst
545-CHSPE050	Løs lastkrog for håndkædetalje - 500kg.
545-CHSPE100	Løs lastkrog for håndkædetalje - 1000kg.
545-CHSPE200	Løs lastkrog for håndkædetalje - 2000kg.

Varenummer	Tekst
545-CKK025	Kæde for skraldetalje 545-CK-025
545-CKK075	Kæde for skraldetalje 545-CK075
545-CKK150	Kæde for skraldetalje 545-CK150

Varenummer	Tekst
545-CKP025	Rep. set for kroge skraldetalje - 250kg.
545-CKP075	Rep. set for kroge skraldetalje - 750kg.
545-CKP150	Rep. set for kroge skraldetalje - 1500kg.

Varenummer	Tekst
545-CKSPE025	Løs lastkrog for skraldetalje - 250kg.
545-CKSPE075	Løs lastkrog for skraldetalje - 750kg.
545-CKSPE150	Løs lastkrog for skraldetalje - 1500kg.

Varenummer	Tekst
545-EHBK025	Løs kæde for Eltalje 250/500 kg . Type EHB
545-EHBK100	Løs kæde for Eltalje 1000 kg . Type EHB
545-EHBK200	Løs kæde for Eltalje 2000 kg . Type EHB

Varenummer	Tekst
545-EHBKS025	Kædesæk for Eltalje 250/500 kg f 5 mtr. kæde
545-EHBKS100	Kædesæk for Eltalje 1000 kg for 5 mtr. kæde
545-EHBKS200	Kædesæk for Eltalje 2000 kg for 5 mtr. kæde

Varenummer	Tekst
545-EHBTSPE025	Løs top krog for Eltalje 250/500 kg
545-EHBTSPE100	Løs top krog for Eltalje 1000 kg
545-EHBTSPE200	Løs top krog for Eltalje 2000 kg

Varenummer	Tekst
545-EHBUSPE025	Løs kædekrog for Eltalje 250/500 kg
545-EHBUSPE100	Løs kædekrog for Eltalje 1000 kg
545-EHBUSPE200	Løs kædekrog for Eltalje 2000 kg

# MAASDAM POWER PULL

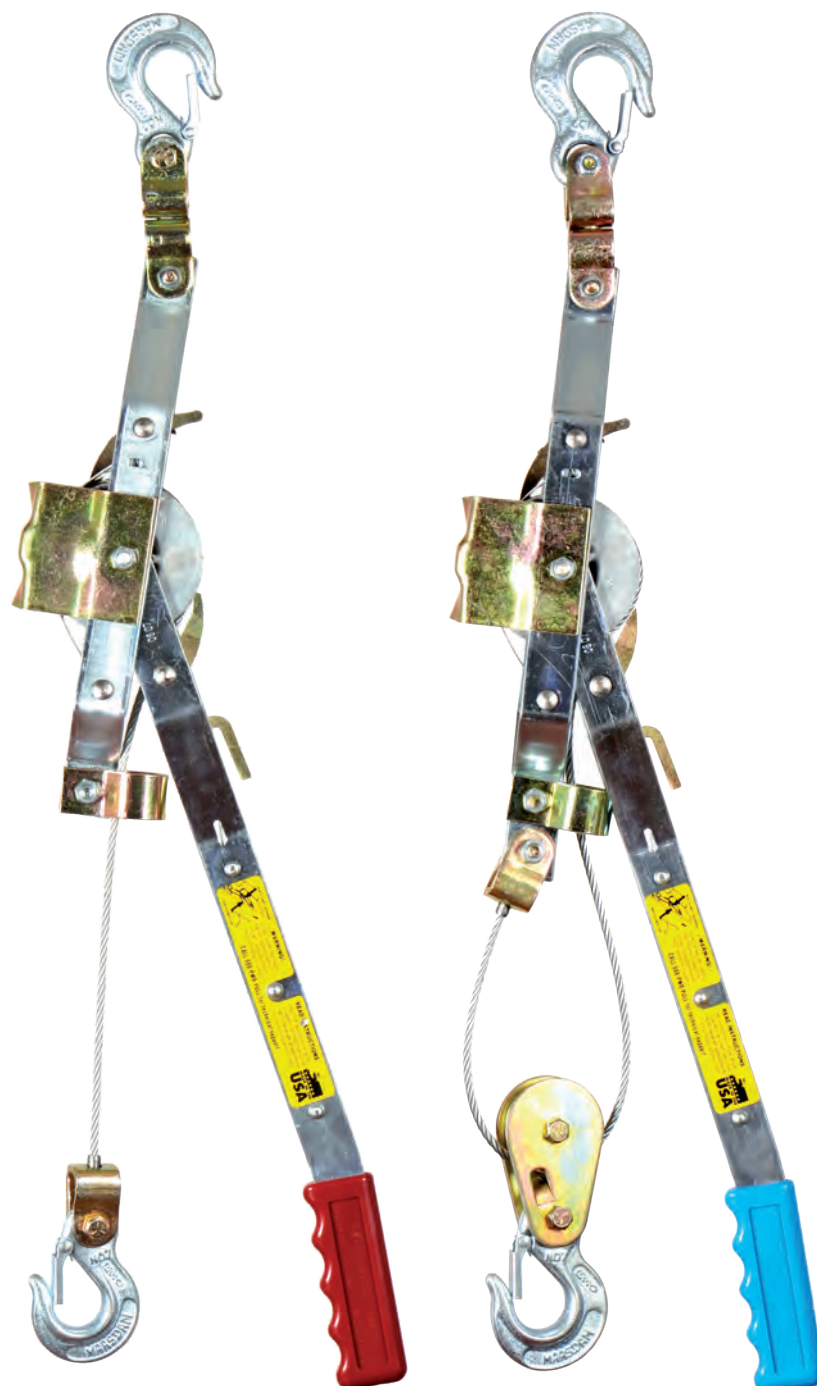

## Wire Skraldetalje

Varenummer	Kg (Løft) Kg (Træk) Wire		
545-144S6	454 kg.	907 kg.	3,66 mtr.
545-144SB6	750 kg.	1814 kg.	1,83 mtr.

# EL TALJER



Vare nr.	Løfte kapacitet kg.	Løftehøjde	Løfthastighed m/min	Kæde dim.	VÆGT kg.
545-EHB025	250	5 m	10	6,3 mm	31
545-EHB050	500	5 m	8	6,3 mm	32
545-EHB100	1.000	5 m	8,3	8,0 mm	60
545-EHB200	2.000	5 m	3,2	8,0 mm	70

400V. Komplet med standard kæde, kædekasse, 5 m. løft, styrekabel med indbygget aflastningswire og betjeningshåndtag med nødstop samt ophængsøje. 2 hastigheder

# LØBEKAT

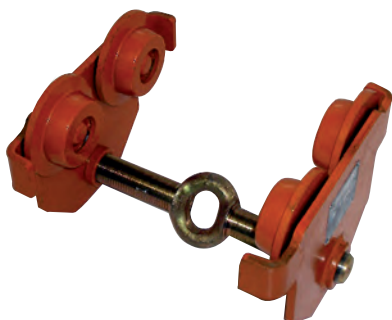

Varenummer	Bredde	Max.
5422001-0500	50-220mm	500 kg
5422001-1000	58-220 mm	1000 kg
5422001-2000	66-220 mm	2000 kg
5422001-3000	74-220 mm	3000 kg
5422001-5000	90-220 mm	5000 kg



# TRÆK- OG LØFTEKÆDER

Ståltrækkæde 4 meter, inkl. opkorterokrog m. pal

Vare nr.	Type	Dim
542-KT7/8	Grade 80	8
542-KT10	Grade 80	10
542-KT13	Grade 80	13



## KÆDER & ØJER G80

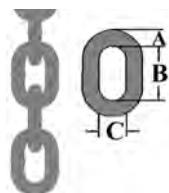

### Løftekæde klasse 8, EN818-2 DIN 5687

Varenummer	A	B	C	Max.
542-K7	7	21	11,9	1,5 t
542-K8	8	24	13,6	2,0 t
542-K10	10	30	17	3,15 t
542-K13	13	39	22,1	5,3 t
542-K16	16	48	27,2	8,0 t
542-K19	20	60	34	12,5 t

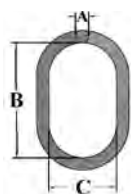

### Løfteøje svejst TPLS, MasterLink

Varenummer	A	B	C	Max.
542-TPLS7/8	16	110	60	2,2 t
542-TPLS10	18	135	75	3,2 t
542-TPLS13	22	160	90	5,3 t
542-TPLS16	26	180	100	8,0 t

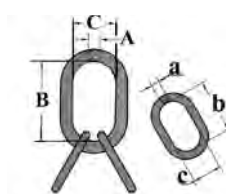

### Løfteøje LHE, Flerparts MasterLink

Varenummer	A/a	B/b	C/c	Max.
542-LHE7/8	20/14	160/100	90/60	4,25 t
542-LHE10	22/18	180/150	100/70	6,7 t
542-LHE13	28/22	270/160	140/90	11,2 t
542-LHE16	32/25	270/180	140/100	17,0 t

# KROGE G80

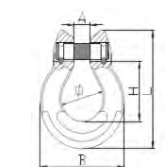
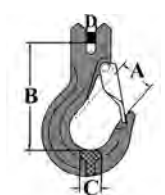
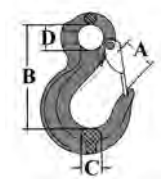

## Koblingsled KBL, Con-link

Varenummer	A	B	C	Max.	Art.
542-KBL6	45,4	14	7,9	1,12 t	6
542-KBL7/8	59,0	20	10,0	2,00 t	8
542-KBL10	68,0	25,0	12,7	3,15 t	10
542-KBL13	84,8	26,3	16,6	5,30 t	13
542-KBL16	106,0	36,0	21,0	8,00 t	16

## Sikkerhedskrog SKG, med clevis

Varenummer	A	B	C	D	Max.	Art.
542-SKG7/8	35,0	123,0	25,0	10,0	2,00 t	BKG7/8-8
542-SKG10	45,0	150,0	36,0	12,0	3,15 t	BKG10-8
542-SKG13	56,0	190,0	41,0	16,0	5,30 t	BKG13-8
542-SKG16	68,0	220,0	51,0	20,0	8,00 t	BKG16-8

## Sikkerhedskrog SKE, BK type krog m. øje

Varenummer	A	B	C	D	Max.	Art.
542-SKE7/8	38,0	134,0	26,0	25,0	2,00 t	7/8
542-SKE10	52,0	168,0	36,0	31,5	3,15 t	10
542-SKE13	62,0	209,0	41,0	39,5	5,30 t	13
542-SKE16	70,0	260,0	55,0	50,0	8,00 t	16

## Sikkerhedskrog SKS, med swirvel

Varenummer	A	B	C	D	Max.	Art.
542-SKS7/8	39,0	175,0	29,0	38,0	2,00 t	7/8
542-SKS10	55,0	216,0	36,0	40,0	3,15 t	10
542-SKS13	63,0	279,0	43,0	63,0	5,30 t	13

## Lastkrog SPE, med øje og spærre

Varenummer	A	B	C	D	Max.	Art.
542-SPE7/8	27,0	95,0	18,0	24,0	2,00 t	EKN7/8-8
542-SPE10	33,0	120,0	23,0	32,8	3,15 t	EKN10-8
542-SPE13	42,0	145,0	30,0	41,0	5,30 t	EKN13-8
542-SPE16	49,0	184,0	32,0	50,0	8,00 t	EKN16-8

## Lastkrog SPG, med clevis og spærre

Varenummer	A	B	C	D	Max.	Art.
542-SPG7/8	26,0	87,0	19,4	9,0	2,00 t	EKGN7/8-8
542-SPG10	33,0	104,0	23,0	12,0	3,15 t	EKGN10-8
542-SPG13	43,0	127,0	29,0	16,0	5,30 t	EKGN13-8
542-SPG16	54,0	146,0	38,0	21,0	8,00 t	EKGN16-8

## Omega link

Varenummer	A	B	H	L	Ø	Max T
542-OL07/8	10,0	52,0	35,0	68,5	23,5	2,0
542-OL10	12,0	62,0	40,5	81,0	31,5	3,2
542-OL13	15,0	81,0	54,0	108,0	41,0	5,3
542-OL16	19,0	99,0	64,0	126,0	49,5	8,0

# KROGE G80

## Lastkrog SPS, med swirvel

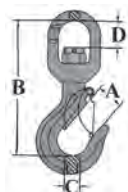

Varenummer	A	B	C	D	Max.
542-SPS7/8	26,0	154,0	18,0	25,0	2,00 t
542-SPS10	34,0	189,0	23,0	33,0	3,15 t
542-SPS13	42,0	233,0	28,0	40,0	5,30 t
542-SPS16	49,0	279,0	33,0	54,0	8,00 t
542-SPS18	80,0	312,0	38,0	62,0	12,50 t

## Svejseskrog UGK

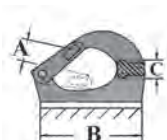

Varenummer	A	B	C	D	Max.
542-UGK01	18,0	87,0	-	1,0	1,0
542-UGK2	2,0	95,0	17,0	2 t	2 t
542-UGK3	29,0	114,0	30,0	3 t	3 t
542-UGK5	34,0	166,0	46,0	5 t	5 t
542-UGK8	35,0	173,0	39,0	8 t	8 t
542-UGK10	50,0	221,0	44,0	10 t	10 t

## Opkortekrog INK, med øje

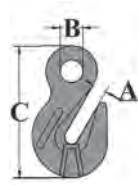

Varenummer	A	B	C	Max.
542-INK7/8	9,8	15,0	65,0	2,00 t
542-INK10	12,3	20,0	84,0	3,15 t
542-INK13	16,5	25,0	104,0	5,30 t
542-INK16	20,0	30,0	130,0	8,00 t

## Opkortekrog INKG, med clevis

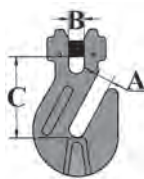

Varenummer	A	B	C	Max.
542-INKG7/8	10,5	10,5	50,0	2,00 t
542-INKG10	12,4	14,5	72,0	3,15 t
542-INKG13	13,5	15,5	90,0	5,30 t
542-INKG16	20,0	17,0	102,0	8,00 t

## Støberikrog SLE med øje

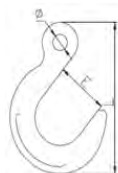

Varenummer	E	Ø	L	Max T
542-SLE07-8	63,5	18	163	3,5
542-SLE10	76	22	200	7,1
542-SLE13	89	27	238	12,0
542-SLE16	102	32	278	18,1

## Kædestrammer med skralde

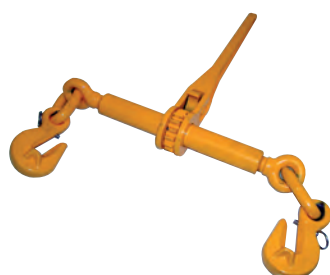

Varenummer	Kæde dim.	Brudstyrke ton	Max. last ton
542-06000KL	6	5,5	1,75
542-08000KL	7/8	8	4
542-15000KL	10	15	7,5
542-18000KL	13	20	10
542-21000KL	16	32	16

# KÆDESLING G80

## Kæde, 1-part m. spærrekrog



Type nr.	Dim.	Max.	Kæde	Øje	Led	Krog
<b>1SPE-6</b>	6	1,12 t	K-6	TPL-6	KBL-6	SPE-6
<b>1SPE-7</b>	7	1,5 t	K-7	TPL-6	KBL-7/8	SPE-7/8
<b>1SPE-8</b>	8	2,0 t	K-8	TPL-7/8	KBL-7/8	SPE-7/8
<b>1SPE-10</b>	10	3,15 t	K-10	TPL-10	KBL-10	SPE-10
<b>1SPE-13</b>	13	5,3 t	K-13	TPL-13	KBL-13	SPE-13
<b>1SPE-16</b>	16	8,0 t	K-16	TPL-16	KBL-16	SPE-16
<b>1SPE-20</b>	20	12,5 t	K-20	TPL-22	KBL-18/20	SPE-20
<b>1SPE-22</b>	22	15,0 t	K-22	TPL-22	KBL-22	SPE-22
<b>1SPE-26</b>	26	21,2 t	K-26	TPL-26	KBL-26	SPE-26

## Kæde, 2-part m. spærrekroge



Type nr.	Dim.	Max. 0-45°	Max. 45-60°	Kæde	Øje	Led	Krog
<b>2SPE-6</b>	6	1,6 t	1,12 t	K-6	TPL-6	KBL-6	SPE-6
<b>2SPE-7</b>	7	2,1 t	1,5 t	K-7	TPL-7/8	KBL-7/8	SPE-7/8
<b>2SPE-8</b>	8	2,8 t	2,0 t	K-8	TPL-10	KBL-7/8	SPE-7/8
<b>2SPE-10</b>	10	4,25 t	3,15 t	K-10	TPL-13	KBL-10	SPE-10
<b>2SPE-13</b>	13	7,5 t	5,3 t	K-13	TPL-16	KBL-13	SPE-13
<b>2SPE-16</b>	16	11,2 t	8,0 t	K-16	TPL-18/16	KBL-16	SPE-16
<b>2SPE-20</b>	20	17,0 t	12,5 t	K-20	TPL-22/20	KBL-18/20	SPE-20
<b>2SPE-22</b>	22	21,2 t	15,0 t	K-22	TPL-26	KBL-22	SPE-22
<b>2SPE-26</b>	26	30,0 t	21,2 t	K-26	TPL-32	KBL-26	SPE-26
<b>2SPEINK-32</b>	32	45,0 t	31,5 t	K-32	TPL-36	KBL-32	SPE-32

## Kæde, 3-part m. spærrekroge



Type nr.	Dim.	Max. 0-45°	Max. 45-60°	Kæde	Øje	Led	Krog
<b>3SPE-6</b>	6	2,36 t	1,7 t	K-6	LHE-6	KBL-6	SPE-6
<b>3SPE-7</b>	7	3,15 t	2,24 t	K-7	LHE-8	KBL-7/8	SPE-7/8
<b>3SPE-8</b>	8	4,25 t	3,0 t	K-8	LHE-8	KBL-7/8	SPE-7/8
<b>3SPE-10</b>	10	6,7 t	4,75 t	K-10	LHE-10	KBL-10	SPE-10
<b>3SPE-13</b>	13	11,2 t	8,0 t	K-13	LHE-13	KBL-13	SPE-13
<b>3SPE-16</b>	16	17,0 t	11,8 t	K-16	LHE-16	KBL-16	SPE-16
<b>3SPE-20</b>	20	26,5 t	19,0 t	K-20	LHE-20	KBL-20	SPE-20
<b>3SPE-22</b>	22	31,5 t	22,4 t	K-22	LHE-22	KBL-22	SPE-22
<b>3SPE-26</b>	26	45,0 t	31,5 t	K-26	LHE-26	KBL-26	SPE-26

## Kæde, 4-part m. spærrekroge



Type nr.	Dim.	Max. 0-45°	Max. 45-60°	Kæde	Øje	Led	Krog
<b>4SPE-6</b>	6	2,36 t	1,7 t	K-6	LHE-6	KBL-6	SPE-6
<b>4SPE-7</b>	7	3,15 t	2,24 t	K-7	LHE-8	KBL-7/8	SPE-7/8
<b>4SPE-8</b>	8	4,25 t	3,0 t	K-8	LHE-8	KBL-7/8	SPE-7/8
<b>4SPE-10</b>	10	6,7 t	4,75 t	K-10	LHE-10	KBL-10	SPE-10
<b>4SPE-13</b>	13	11,2 t	8,0 t	K-13	LHE-13	KBL-13	SPE-13
<b>4SPE-16</b>	16	17,0 t	11,8 t	K-16	LHE-16	KBL-16	SPE-16
<b>4SPE-20</b>	20	26,5 t	19,0 t	K-20	LHE-20	KBL-20	SPE-20
<b>4SPE-22</b>	22	31,5 t	22,4 t	K-22	LHE-22	KBL-22	SPE-22
<b>4SPE-26</b>	26	45,0 t	31,5 t	K-26	LHE-26	KBL-26	SPE-26
<b>4SPE-32</b>	32	36,0 t	47,5 t	K-32	LHE-32	KBL-32	SPE-32



# KROGE G100

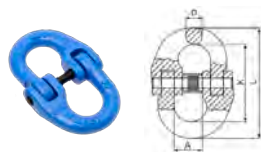

## Koblingsled KBL, Con-link

Varenummer	A	D	K	L	Max. T
542-ZKBL6	14,0	7,0	44,5	60,0	1,4
542-ZKBL8	18,5	10,0	61,5	82,5	2,5
542-ZKBL10	23,0	12,6	72,0	97,2	4,0
542-ZKBL13	28,0	16,5	92,0	125,0	6,7
542-ZKBL16	33,5	20,0	107,0	147,0	10,0

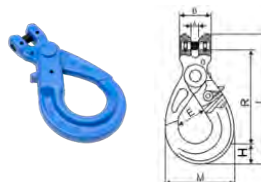

## Sikkerhedskrog SKG, med clevis

Varenummer	A	B	M	R	Max. T
542-ZSKG8	9,5	36,0	90,0	123,0	2,5
542-ZSKG10	12,0	46,0	109,0	144,0	4,0
542-ZSKG13	15,0	59,0	138,5	182,0	6,7
542-ZSKG16	18,5	70,0	170,5	220,0	10,0

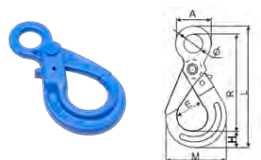

## Sikkerhedskrog SKE, BK type krog m. øje

Varenummer	A	E	L	R	Ø	Max. T
542-ZSKG8	52,0	35,5	175,0	137,0	27,0	2,5
542-ZSKG10	64,5	45,0	212,5	170,0	34,5	4,0
542-ZSKG13	80,0	53,5	270,0	209,0	40,0	6,7
542-ZSKG16	104,0	61,0	333,0	256,0	50,0	10,0

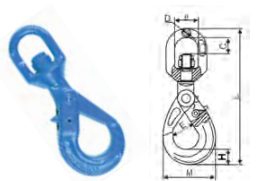

## Sikkerhedskrog SKS, med swirvel

Varenummer	A	B	C	D	Max. T
542-ZSKS8	39,0	175,0	29,0	38,0	2,00 t
542-ZSKS10	55,0	216,0	36,0	40,0	3,15 t
542-ZSKS13	63,0	279,0	43,0	63,0	5,30 t



## Lastkrog SPE, med øje og spærre

Varenummer	D	E	H	Ø	Max. T
542-ZSPE8	11,0	25,0	27,5	25,0	2,5
542-ZSPE10	16,0	28,0	33,0	34,0	4,0
542-ZSPE13	19,0	38,0	43,5	43,0	6,7
542-ZSPE16	24,5	46,0	50,0	50,0	10,0



## Lastkrog SPG, med clevis og spærre

Varenummer	A	B	E	H	Max. T
542-ZSPG8	9,5	37,0	25,0	9,0	2,5
542-ZSPG10	12,0	48,0	28,0	12,0	4,0
542-ZSPG13	15,0	59,0	38,0	16,0	6,7
542-ZSPG16	17,5	70,0	44,0	21,0	10,0

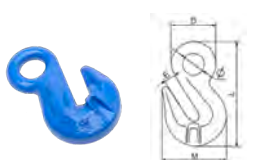

## Opkortekrog ZINK, med øje

Varenummer	A	B	C	Max.
542-ZINK8	9,8	15,0	65,0	2,00 t
542-ZINK10	12,3	20,0	84,0	3,15 t
542-ZINK13	16,5	25,0	104,0	5,30 t
542-ZINK16	20,0	30,0	130,0	8,00 t

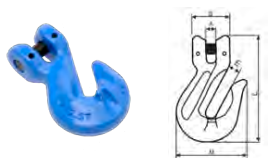

## Opkortekrog ZINKG, med clevis

Varenummer	A	B	E	M	Max. T
542-ZINKG8	9,5	36,0	10,8	53,0	2,5
542-ZINKG10	12,0	46,0	13,5	72,0	4,0
542-ZINKG13	15,0	59,0	16,5	96,0	6,7
542-ZINKG16	17,5	70,0	19,2	112,5	10,0

# KÆDESLING G100

## Kæde, 1-part m. spærrekrog



Type nr.	Dim.	Max.	Kæde	Øje	Led	Krog
<b>1ZSPE-6</b>	6	1,4 t	K-6	ZTPL-6	ZKBL-6	ZSPE-6
<b>1ZSPE-7</b>	7	1,9 t	K-7	ZTPL-6	ZKBL-8	ZSPE-8
<b>1ZSPE-8</b>	8	2,5 t	K-8	ZTPL-8	ZKBL-8	ZSPE-8
<b>1ZSPE-10</b>	10	4,0 t	K-10	ZTPL-10	ZKBL-10	ZSPE-10
<b>1ZSPE-13</b>	13	6,7 t	K-13	ZTPL-13	ZKBL-13	ZSPE-13
<b>1ZSPE-16</b>	16	10,0 t	K-16	ZTPL-16	ZKBL-16	ZSPE-16

## Kæde, 2-part m. spærrekroge



Type nr.	Dim.	Max. 0-45°	Max. 45-60°	Kæde	Øje	Led	Krog
<b>2ZSPE-6</b>	6	2,0 t	1,4 t	K-6	ZTPL-6	ZKBL-6	ZSPE-6
<b>2ZSPE-7</b>	7	2,65 t	1,9 t	K-7	ZTPL-8	ZKBL-8	ZSPE-8
<b>2ZSPE-8</b>	8	3,55 t	2,5 t	K-8	ZTPL-8	ZKBL-8	ZSPE-8
<b>2ZSPE-10</b>	10	5,6 t	4,0 t	K-10	ZTPL-10	ZKBL-10	ZSPE-10
<b>2ZSPE-13</b>	13	9,5 t	6,7 t	K-13	ZTPL-13	ZKBL-13	ZSPE-13
<b>2ZSPE-16</b>	16	14,0 t	10,0 t	K-16	ZTPL-16	ZKBL-16	ZSPE-16

## Kæde, 3-part m. spærrekroge



Type nr.	Dim.	Max. 0-45°	Max. 45-60°	Kæde	Øje	Led	Krog
<b>3ZSPE-6</b>	6	3,0 t	2,12 t	K-6	ZLHE-6	ZKBL-6	ZZSPE-6
<b>3ZSPE-7</b>	7	4,0 t	2,8 t	K-7	ZLHE-8	ZKBL-8	ZSPE-8
<b>3ZSPE-8</b>	8	5,3 t	3,75 t	K-8	ZLHE-8	ZKBL-8	ZSPE-8
<b>3ZSPE-10</b>	10	8,0 t	6,0 t	K-10	ZLHE-10	ZKBL-10	ZSPE-10
<b>3ZSPE-13</b>	13	14,0 t	10,0 t	K-13	ZLHE-13	ZKBL-13	ZSPE-13
<b>3ZSPE-16</b>	16	21,2 t	15,0 t	K-16	ZLHE-16	ZKBL-16	ZSPE-16

## Kæde, 4-part m. spærrekroge



Type nr.	Dim.	Max. 0-45°	Max. 45-60°	Kæde	Øje	Led	Krog
<b>4ZSPE-6</b>	6	3,0 t	2,12 t	K-6	ZLHE-6	ZKBL-6	ZSPE-6
<b>4ZSPE-7</b>	7	4,0 t	2,8 t	K-7	ZLHE-8	ZKBL-8	ZSPE-8
<b>4ZSPE-8</b>	8	5,3 t	3,75 t	K-8	ZLHE-8	ZKBL-8	ZSPE-8
<b>4ZSPE-10</b>	10	8,0 t	6,0 t	K-10	ZLHE-10	ZKBL-10	ZSPE-10
<b>4ZSPE-13</b>	13	14,0 t	10,0 t	K-13	ZLHE-13	ZKBL-13	ZSPE-13
<b>4ZSPE-16</b>	16	21,2 t	15,0 t	K-16	ZLHE-16	ZKBL-16	ZSPE-16

# SJÆKLER OG ØJER

## H sjækkel RED PIN m. øjebolt

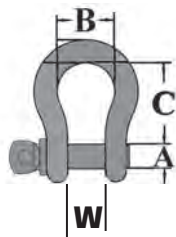

Varenummer	A - Bolt Ø mm	A - Bolt Ø "	W mm	Gods Ø mm	SWL ton
542-USAL08	8	1/4"	12	6	0,50
542-USAL10	10	5/16"	13	8	0,75
542-USAL11	11	3/8"	16	10	1,00
542-USAL13	13	7/16"	18	11	1,50
542-USAL16	16	1/2"	21	13	2,0
542-USAL19	19	5/8"	28	16	3,25
542-USAL22	22	3/4"	32	19	4,75
542-USAL25	25	7/8"	36	22	6,50
542-USAL29	29	1"	43	25	8,50
542-USAL32	32	1 1/8"	46	29	9,50
542-USAL35	35	1 1/4"	52	32	12,00
542-USAL38	38	1 3/8"	56	35	13,50
542-USAL41	41	1 1/2"	60	38	17,00
542-USAL51	51	1 3/4"	73	45	25,00

Sikkerhedsfaktor 1:6

## Løfteøje LES

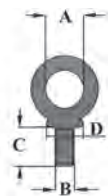

Varenummer	A	B	C	D	Max.
542-LES8	20	M8	13,0	20	140 kg
542-LES10	25	M10	17,0	25	230 kg
542-LES12	30	M12	20,5	30	340 kg
542-LES16	35	M16	27,0	35	700 kg
542-LES20	40	M20	30,0	40	1200 kg
542-LES24	50	M24	36,0	50	1800 kg
542-LES30	60	M30	45,0	60	3600 kg

Sikkerhedsfaktor 1:4



## Løfteøje LEN

Varenummer	A	B	C	Max.
542-LEN8	20	20	M8	140 kg
542-LEN10	25	25	M10	230 kg
542-LEN12	30	30	M12	340 kg
542-LEN16	35	35	M16	700 kg
542-LEN20	40	40	M20	1200 kg
542-LEN24	50	50	M24	1800 kg
542-LEN30	60	60	M30	3600 kg

Sikkerhedsfaktor 1:4

# SPANSET PowerSTAR

Båndstropper med SECUTEX beskyttelse.

PB XXXX = med polyester øje i hver ende.  
PB XXXX DD = med stål D-øje i begge ender.



SF-1 Secutex = Anti-cut beskyttelse på 1-side

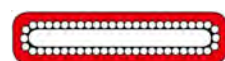

SF-2 Secutex = Anti-cut beskyttelse på 2-sider



Clip-SC Secutex = Anti-Cut, kan åbnes på bagsiden for fleksibel brug. Beskyttelse på 1-side

	Farve kode efter CEN Euro norm	Nominal løftekapacitet (kg)	Bredde løfteøje (mm)	Længde løfteøje (mm)	Arbejds-længde L1 (m)	Bånd bredde (mm)	Bånd tykkelse (mm)	Vægt første m. (kg)	Vægt pr løbende meter (kg)
<b>PB 1000</b>	Violet	1.000	30	300	1,0	30	5,6	0,3	0,2
<b>PB 2000</b>	Grøn	2.000	35	300	1,0	60	5,6	0,6	0,4
<b>PB 3000</b>	Gul	3.000	50	400	1,3	90	6,0	1,0	0,6
<b>PB 4000</b>	Grå	4.000	65	400	1,3	120	6,2	1,4	0,8
<b>PB 5000</b>	Rød	5.000	80	500	1,5	150	6,4	1,7	1,0
<b>PB 6000</b>	Brun	6.000	70	700	1,9	180	7,6	2,2	1,2
<b>PB 8000</b>	Blå	8.000	90	800	2,2	240	7,6	2,9	1,6
<b>PB 10000</b>	Orange	10.000	160	1.000	2,6	300	7,6	4,1	2,2
<b>PB 1000 DD</b>	Violet	1.000	-	-	1,0	30	5,6	1,4	0,2
<b>PB 2000 DD</b>	Grøn	2.000	-	-	1,0	60	5,6	2,2	0,4
<b>PB 3000 DD</b>	Gul	3.000	-	-	1,3	90	6,0	4,2	0,6
<b>PB 4000 DD</b>	Grå	4.000	-	-	1,3	120	6,2	5,4	0,8
<b>PB 5000 DD</b>	Rød	5.000	-	-	1,5	150	6,4	9,0	1,0
<b>PB 6000 DD</b>	Brun	6.000	-	-	1,9	180	7,6	15,2	1,2
<b>PB 8000 DD</b>	Blå	8.000	-	-	2,2	240	7,6	22,6	1,6
<b>PB 10000 DD</b>	Orange	10.000	-	-	2,6	300	7,6	35,2	2,2



# SECUTEX

Buffer med indstøbt forstærkning.  
Monteres med bolt, nitte eller skrue.



- Den indstøbte forstærkning forhindrer langsgående og tværgående ekspansion.
- Enkel fastgørelse med bolte eller nitter



1. Forstærket plade - standard.



2. Forstærket plade - standard med påsvejst stålplade.



3. Forstærket plade - Heavy Duty version



4. Forstærket version - rustfri stål plade.

Anvendelsesområder:

- Vægge, gulve, overflader der skal beskyttes, transportudstyr
- Overalt, hvor varer skal beskyttes
- Reducerer slid
- Støjreduktion, kollisionsbeskyttelse

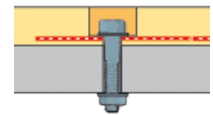

Bolt og møtrik

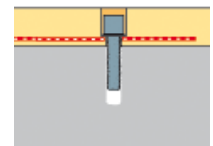

Hexagon skrue

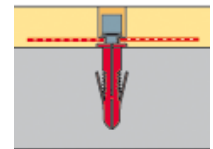

Hexagon skrue  
med dyvel

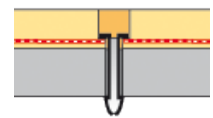

Nitte

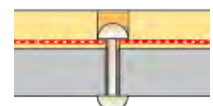

Pop nitte

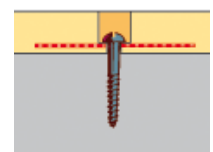

Træskrue

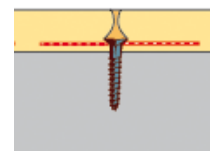

Selvskærende

# BÅDSTROPPER

Sørensen & Kofoed A/S leverer kundespecifikke bådstopper.  
Ring for yderligere information 4492 1088



# LØFTEKLO



Varenr.	WLL kg	Gab mm	Egenvægt kg
<b>HP0050</b>	500	0-15	1,9
<b>HP0100</b>	1.000	0-20	4,8
<b>HP0200</b>	2.000	0-25	6,5
<b>HP0300</b>	3.000	0-30	15
<b>HP0500</b>	5.000	0-50	23

# SVIRVEL ØJEBOLT MED KUGLELEJE



Varenr.	WLL ton	Str. mm	Løfte øje mål mm	Egenvægt kg
<b>801110</b>	0,6	10x18	13x55x30	0,41
<b>8011h12</b>	1	12x18	13x55x30	0,42
<b>801114</b>	1,5	14x20	13x55x30	-
<b>801116</b>	2	16x20	13x55x30	0,44
<b>801118</b>	3	18x30	16x70x34	-
<b>801120</b>	4	20x30	16x70x34	0,95
<b>801124</b>	6,3	24x30	18x85x40	1,44
<b>801130</b>	12	30x35	22x115x50	3,58
<b>801136</b>	15	36x50	22x115x50	3,73
<b>801142</b>	15	42x50	22x115x50	3,89
<b>801145</b>	22,4	45x60	28x140x65	6,84
<b>801148</b>	22,4	48x60	28x140x65	7,37
<b>801156</b>	23,6	58x78	28x140x65	7,56
<b>801164</b>	25	64x110	36x170x75	17,66
<b>801180</b>	31,5	80x150	36x170x75	20,5
<b>801190</b>	40	90x150	40x170x80	22,5

# BJÆLKEKLO

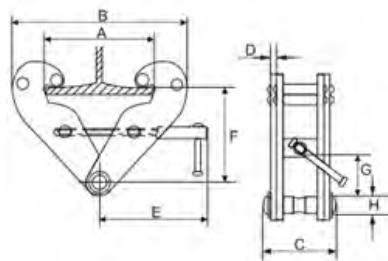

Model		542BC010	542BC020	542BC030	542BC050	542BC100	
Kapacitet	t	1	2	3	5	10	
Prøve belastning	kN	14,7	29,4	44,1	73,5	147	
Bjælke bredde	mm	75-230	75-230	80-345	80-345	90-350	
Dim mm.	A max	240	240	355	355	360	
	B	min	192	192	243	243	272
		max	367	367	520	520	532
	C	94	102	132	142	180	
	D	4	6	8	10	12	
	E	194	194	241	241	284	
	F	min	102	102	133	133	155
		max	154	154	223	223	234
	G	22	22	38	35	47	
	H	20	20	22	28	38	
Vægt	kg	4	4,8	9,8	11,6	17	

# KASTEBLOK

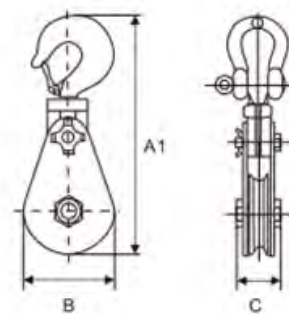

Model	Skive mm	KapacitetT	A1(mm)	B mm	C mm	Wire Ø mm	Net. vægt kg
HB07502	75	2	292	82	70	7-9	3,9
HB11504	115	4	358	120	70	10-12	6,2
HB15004	150	4	412	160	70	16-18	8,4
HB15008	150	8	498	160	93	20-22	14,1
HB20008	200	8	549	210	93	20-22	19
HB20015	200	15	672	230	102	22-24	34
HB25010	250	10	695	260	115	24-26	36

# HÅNDSPIL

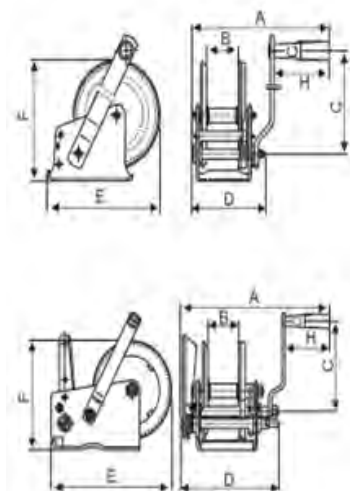

Model	Kapacitet	Proof Load	Gear	Hastighed	Dimensioner (mm)							N.W.
	KG	kN			A	B	C	D	E	F	H	kg
HWB600	265	4	2.9:1	1	228	51	180	119	165	138	91	2,4
HWB800	355	5,4	3.7:1	1	228	51	180	119	165	138	91	2,5
HWB1000	440	6,7	4.2:1	1	228	51	180	119	184	156	91	2,8
HWB1200	530	8	4.2:1	1	228	51	180	119	184	156	91	2,8
HWB1400	620	9,4	4.2:1	1	228	51	180	119	184	156	91	2,8
HWB2000	885	13,4	10.35:1/4.5:1	2	281	65	251	174	250	182	91	5,9
HWB2500	1100	16,7	11.5:1/5:1	2	281	65	251	174	256	191	91	6,4

# KÆDESTRAMMER MANUEL



Item		LLGH08	LLGH10	LLGH13	LLGH16
Min-Max Kæde	cm	1/4-5/16	5/16-3/8	3/8-1/2	1/2-5/8
Working Load Limit	kg	1.175	2.450	4.170	4.989
Proof Load	kg	2.350	4.900	8.340	9.977
Minimum Ultimate Load	kg	3.535	8.600	12.698	14.966
Weight/Each	kg	2	4	6	9
Handle/Length	cm	29	39	44	53
Dimensioner (cm)	A	47	64	72	86
	B	44	59	67	77
	C	36	50	56	65
	D	29	39	45	53
	E	21	28	33	36
	F	20	28	31	36
	G	0,89	1,30	1,50	1,50



# PERMANENT MAGNET LØFTER

## ENHÅNDSBETJENT

Permanent magnetløfteren er fleksibel, let at betjene og sikker  
 Kræver minimal vedligeholdelse og bevarer sin magnetkraft i hele magnetens levetid  
 På siden af magneten er angivet løftekapaciteten ved forskellig materiale-tykkelse  
 Forsynet med sjækel ophæng og gummihåndtag  
 Vi kan endvidere tilbyde elektropermanente magnetløftere også til runde emner



Varenr.	Type	WWL kg	Rundeemner kg	Temperatur område C°	Egenvægt kg
LM001	PLM-1	100	30	-40/+80	3
LM003	PLM-3	300	100	-40/+80	10
LM006	PLM-6	600	200	-40/+80	20
LM010	PLM-10	1.000	300	-40/+80	37
LM020	PLM-20	2.000	600	-40/+80	80
LM030	PLM-30	3.000	1.000	-40/+80	160

# DYNAMOMETER

## Dynamometer

Nøjagtighed +/- 0,8% af max kapacitet  
 Med LCD display -10 grader til +40 grader C (5 cifre, 18mm højde)  
 Arbejdstemperatur -10 grader til +40 grader C  
 Vejrbestandig og støvtæt i henhold til EN 60 529: IP 65  
 Hus i lakeret aluminium alloy  
 Strømforsyning: AA Batterier



Varenr.	Kap. tons	Nøjagtighed 0,8% kg	Min. belastn. kg	Testbelastning kg	Max display kg	Vægt kg
KVD002	0,25	2	0,5	0,5	250	1,1
KVD005	0,5	4	1	1	500	1,1
KVD010	1	8	2	2	1.000	1,1
KVD020	2	15	5	4	2.000	1,3
KVD032	3,2	25	5	6,4	3.200	1,5
KVD064	6,4	50	10	12,8	6.400	2,3

# GALVANISERET STÅLWIRE

Varenr.	Dim. mm	Min.brudstyrke	Vægt kg/m
201006	6	1.610	11,5
201008	8	2.870	20,4
201010	10	4.490	31,8
201012	12	6.460	45,8
201013	13	7.580	53,8
201014	14	8.790	62,4
201016	16	11.500	81,5
201018	18	14.500	103
201020	20	17.900	127
201022	22	21.700	154
201024	24	25.800	183
201026	26	30.300	215

**6 x 24 + FC**

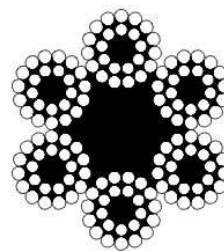

Varenr.	Dim. mm	Min.brudstyrke	Vægt kg/m
231002	2	240	1
231003	3	540	3,25
231004	4	960	5
231047	4,7	1.320	7,3
231005	5	1.500	8,95
231006	6	2.150	13

**6 x 7 + FC**



Varenr.	Dim. mm	Min.brudstyrke	Vægt kg/m
171113	1,3-2,3	110	0,99
171123	2-3	240	2,1
171134	3-4	490	4
171135	3-5	539	5,2
171145	4-5	959	6,7
171146	4-6	960	7,9
171156	5-6	1.499	9
171168	6-8	2.152	9,4
171181	8-10	3850	16

**6 x 7 + FC med PVC**



Vare nr.	Dim mm.	Min. brudstyrke 180-200 kp/mm <sup>2</sup> ca. kg.	Vægt kg/%
451004	4	1040	6,9
451005	5	1480	10
451006	6	2130	14,5
451007	7	2900	19,7
451008	8	3790	25,7
451009	9	4800	32,6
451010	10	5920	40,2
451012	12	7170	57,9
451014	14	1160	78,8
451016	16	15200	103

**19 x 7 Rotationsfri**

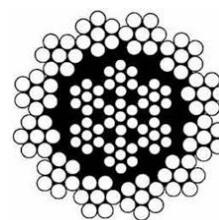

# GALVANISERET STÅLWIRE

Varenr.	Dim. mm	Min.brudstyrke	Vægt kg/m
201006	6	1.610	11,5
201008	8	2.870	20,4
201010	10	4.490	31,8
201012	12	6.460	45,8
201013	13	7.580	53,8
201014	14	8.790	62,4
201016	16	11.500	81,5
201018	18	14.500	103
201020	20	17.900	127
201022	22	21.700	154
201024	24	25.800	183
201026	26	30.300	215

**6 x 24 + FC**

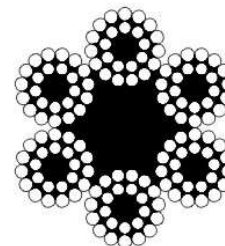

Varenr.	Dim. mm	Min.brudstyrke	Vægt kg/m
231002	2	240	1
231003	3	540	3,25
231004	4	960	5
231047	4,7	1.320	7,3
231005	5	1.500	8,95
231006	6	2.150	13

**6 x 7 + FC**



Varenr.	Dim. mm	Min.brudstyrke	Vægt kg/m
171113	1,3-2,3	110	0,99
171123	2-3	240	2,1
171134	3-4	490	4
171135	3-5	539	5,2
171145	4-5	959	6,7
171146	4-6	960	7,9
171156	5-6	1.499	9
171168	6-8	2.152	9,4
171181	8-10	3850	16

**6 x 7 + FC med PVC**



Vare nr.	Dim mm.	Min. brudstyrke 180-200 kp/mm <sup>2</sup> ca. kg.	Vægt kg/%
451004	4	1040	6,9
451005	5	1480	10
451006	6	2130	14,5
451007	7	2900	19,7
451008	8	3790	25,7
451009	9	4800	32,6
451010	10	5920	40,2
451012	12	7170	57,9
451014	14	1160	78,8
451016	16	15200	103

**19 x 7 Rotationsfri**

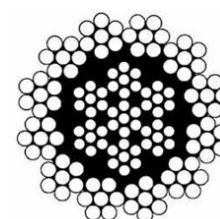

# WIRELÅS - DIN 741

Vare nr.	Str. "	Dim. D1 mm.	Dim. H1 mm.	Dim. A mm.	Vægt kg/%
111003	<b>1/8</b>	<b>4</b>	<b>20</b>	<b>3</b>	<b>1,4</b>
<b>111005</b>	3/16	5	24	5	1,5
<b>111006</b>	1/4	5	28	6	2,1
<b>111008</b>	5/16	6	34	8	4,1
<b>111010</b>	3/8	8	42	10	6,8
<b>111011</b>	7/16	8	44	11	7,2
<b>111013</b>	1/2	10	55	13	13
<b>111014</b>	9/16	10	57	14	13,5
<b>111016</b>	5/8	12	63	16	21
<b>111019</b>	3/4	12	75	19	28
<b>111022</b>	7/8	14	85	22	40
<b>111025</b>	1	14	95	25	44
<b>111030</b>	1 1/8	16	110	28	66
<b>111034</b>	1 1/4	16	120	32	85
<b>111040</b>	1 1/2	16	140	38	104

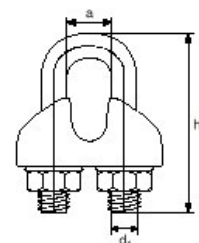

# BARDUNSTRAMMER ØJE/KROG

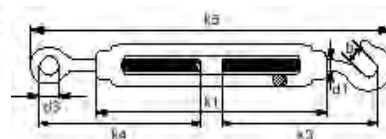

Vare nr.	Str.	D1 mm.	D3 mm.	B mm.	K2 mm.	K3 mm.	K4 mm.	K5 mm.	Brudstyrke WWL ca. ton	Vægt kg/%
401005	<b>5</b>	<b>5</b>	<b>8</b>	<b>7</b>	<b>70</b>	<b>55</b>	<b>56</b>	<b>120-170</b>	<b>95</b>	<b>3,3</b>
<b>401006</b>	6	6	9	8,5	110	85	80	172-252	190	9,5
<b>401008</b>	8	8	10	11	110	85	84	182-257	370	16,5
<b>401010</b>	10	10	14	13,5	125	112	105	213-298	530	29
<b>401012</b>	12	12	16	15,5	125	117	115	238-318	700	43
<b>401014</b>	14	14	18	18,5	140	122	122	263-353		62
<b>401016</b>	16	16	22	19	170	138	165	320-430		92
<b>401018</b>	18	18	23	20	195	170	170	370-510		133
<b>401020</b>	20	20	24	20,5	200	170	167	367-497		163
<b>401022</b>	22	22	27	26	220	185	167	398-543		220
<b>401024</b>	24	24	27	26	255	205	205	447-617		300

# ALU/KOBBER Z WIREKLEMMER

Vare nr.	Vare nr.	Str.	Dim. A
Alu Z	Kobber	mm	mm
1111010	1113010	1,0	1,2
1111015	1113015	1,5	1,7
1111020	1113020	2,0	2,4
1111025	1113025	2,5	2,7
1111030	1113030	3,0	3,3
1111035	1113035	3,5	3,8
1111040	1113040	4,0	4,4
1111045	1113045	4,5	4,9
1111050	1113050	5,0	5,5
1111060	1113060	6,0	6,6
1111065	-	6,5	7,2
1111070	1113070	7,0	7,8
1111080	1113080	8,0	8,8
1111090	1113090	9,0	9,9
1111100	1113100	10,0	10,9
1111110	-	11,0	12,1
1111120	1113120	12,0	13,2
1111130	-	13,0	14,2
1111140	1113140	14,0	15,3
1111160	1113160	16,0	17,5
1111180	-	18,0	19,6
1111200	1113200	20,0	21,7
1111220	1113220	22,0	24,3
1111240	-	24,0	26,4
1111260	-	26,0	28,5
1111280	-	28,0	31
1111300	-	30,0	33,1
1111320	-	32,0	35,2
1111340	-	34,0	37,8
1111360	-	36,0	39,8

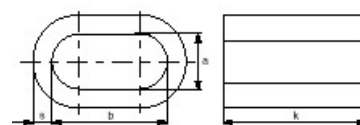



# DUPLEX WIRELÅS

Vare nr.	Str.	Dim. K3 mm	Dim. D mm	Vægt kg/%
111102	2	30	4	0,9
111103	3	35	4	1,4
111104	4	40	5	2,5
111105	5	50	5	3,4
111106	6	60	6	5
111108	8	75	8	10

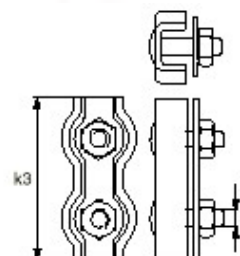

# WIRETALJE



Det selvgribende kæbe-system sikrer præcis positionering af enhver byrde, med ubegrænset wirelængde. Taljen er fremstillet i alloy aluminium, vejer kun lidt og er stort set vedligeholdelsesfri. Brudstiften bryder ved ca. 25% overlast, og håndtaget bøjer ved ca. 50% overlast. Som standard leveres alle taljerne med håndtag og 20 m wire på haspel. Det perfekte løfteværktøj til at trække, løfte, sænke & spænde.

Varenr.	WLL kg	Træk-kap. kg	Wire-dia. mm	Brudstykke kg	Vægt kg	Ydre mål cm
TF0820	800	1.200	8,4	4.800	6,3	43 x 24 x 6
TF1620	1.600	2.500	11,5	8.145	12	54 x 26 x 7,3
TF3220	3.200	5.000	16	16.800	22	66 x 34 x 9,6
-	-	-	-	-	-	-
TFW0820	20	Kompl. wire på haspel	inkl. krog til	800		
TFW1620	20	Kompl. wire på haspel	inkl. krog til	1.600		
TFW3220	20	Kompl. wire på haspel	inkl. krog til	3.200		
TF08	Brudstift	For TF0820				
TF16	Brudstift	For TF1620				
TF32	Brudstift	For TF3200				

# STØTTEBENSPLADER

## Støttebensplader

Varenummer	A	B	C	Max.
<b>4617400-0400</b>	400	400	40	10 t
<b>4617400-0600</b>	400	400	60	20 t
<b>4617500-0400</b>	500	500	40	15 t
<b>4617500-0600</b>	500	500	60	25 t
<b>4617600-0400</b>	600	600	40	15 t
<b>4617600-0600</b>	600	600	60	30 t

Produceret på eget værksted, også på specialmål

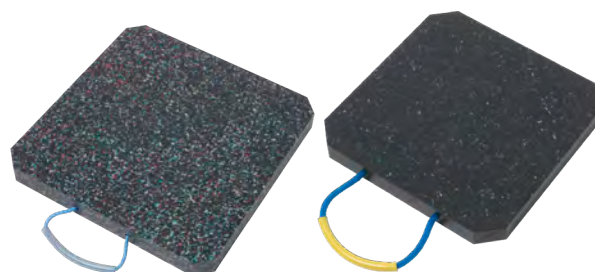

## BÆRESELE (KLAVERSELE)

Bæresele

Varenummer

**541B28000**



## ERGO BÆRESTROPPER

Ergo Bærestrop

Varenummer

**540VH050**

