

TECHNOFLEX®
The Power to Perform

EST. 2008



TECHNOFLEX

POWER TO PERFORM



DENMARK

TECHNOFLEX
POWER TO PERFORM



SAMARBEIDSPARTNERE PARTNER

TECHNOFLEX©



EN NYLIG SUCCES

A NEW SUCCESS

Technoflex kan lave bøsninger med alle former for spline – fra dag til dag.

Technoflex produces sleeves with all types of splines – overnight production.

Eksempel på spline / Examples of splines:

- SAE
- DIN 5480
- DIN 5482
- DIN 5780

Kontakt os på / Contact us at:

E-mail: info@technoflex.dk

Telefon/phone : +45 87 24 45 45



Splin i kobling med klensystem

KOM I GANG MED DET SAMME.

Technoflex har investeret i en notstikker, så nu kan vi tilbyde endnu flere forskellige bearbejdnings på vores værksted.

Attraktiv pris og høj kvalitet, på drejearbejde samt not, mange not og spilne stikning. Vi kan tilbyde totalleverancer lige til døre – nemt, hurtigt og effektivt.

GET STARTED STRAIGHT AWAY

Technoflex has invested in a slotting machine, so now we can offer even more different machining at our workshop.

Attractive pricing and high quality lathe work. Multiple slotting/groove and splines cutting. We offer a complete delivery service- straight to your door. Easy, fast, efficient.

Stikning af not i bundhuller / Cutting of grooves in bottom holes

Stikning op til 50-250 mm / Cutting up to 50-250 mm

Stikning af konisk note / Cutting of conical grooves.

Stikning af noter og splines / Cutting of grooves and splines

Stikning op til 50-250 mm / Cutting up to 50-250 mm

Udlægning af noter i deling / manganot stikning / Layout of grooves in division / multiple grooves cutting

Drejebænk / Lathe:

Pinol højte 270 mm, aksler på 1 meter

Pinol height 270 mm, axel of 1 metre

*»TECHNOFLEX LAYER ALLE FORMER FOR
SPLINE – VI GLÆDER OS TIL AT HJÆLPE DIG.*

»TECHNOFLEX PRODUCES ALL TYPES OF SPLINES – WE LOOK FORWARD TO ASSISTING YOU WITH YOUR NEEDS.

MASKINREPARATION

Technoflex besidder en faglig ekspertise I reparationer af pumper, maskinreparation, gear m.m.

Technoflex har en lang række tekniske special-services på baggrund af de faktiske erfaringer som vi har fået over årene I samarbejde med vores kunder, som består af små som store kunder i mange forskellige brancher.

MACHINE REPAIRS

Technoflex possesses the professional expertise in repairs of pumps, machine repairs, gears and more.

Technoflex has a wide range of technical special services based on the actual experience gained over the years, in cooperation with our customers, including both small and large customers in many different industries.





Special-bøsninger / Special sleeves.

Kontakt os/ Contact Us

+45 87 24 45 45

info@technoflex.dk

www.technoflex.dk

TILBYDER FØLGENDE.

- Service og reparation af alle pumpetyper, uanset fabrikat
- Forebyggende vedligeholdelse
- Udskiftning af lejer uanset typer og fabrikat
- Fejlfinding
- Service og reparation af alle typer ventilatorer, store og små, uanset fabrikat

OUR SERVICES INCLUDE:

- Service and repair of all pump types, regardless of manufacturer
- Preventive maintenance
- Replacement of bearings, regardless of type and make
- Troubleshooting
- Service and repair of all types of fans, large and small, regardless of manufacturer.

ER DER MERE, DU VIL VIDE? / DO YOU NEED MORE INFORMATION?

RING PÅ/ CALL US ON +45 87 24 45 45

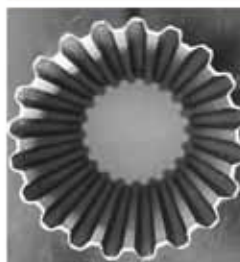

Technoflex Afbalancering Statisk / Dynamisk



Technoflex afbalanceringcenter tilbyder afbalancering af industri- samt marine emner i 1 og 2 plan.

Technoflex tilbyder afbalancering af enkeltopgaver samt større/mindre serier.

Technoflex afbalancering sikrer, at dit system bevarer længst mulig levetid. Et stabilt emne giver længere levetid på lejrer, remme m.m. Alle vores afbalanceringer leveres med dokumentation.

Technoflex afbalanceringsmaskine "schenck" bliver løbende kalibreret for at sikre et nøjagtigt resultat af afbalanceringen.

Dynamisk afbalancering af aksler m.m. op til 500 mm i diameter og max vægt på 150 kg



Afbalanceringsområdet fra G6,3 til G2,5 iht ISO2372 standard kan leveres med certifikat samt fuld sporbarhed.

Eks. på afbalanceringsemner:

- Remskiver
- Aksler
- Pumpehjul
- Svinghjul
- Tandhjul
- Bremseskiver
- Slipsten
- hjul til båndpudser



PRODUKTER:

TECHNOFLEX ©

Magnetiske koblinger består af en ydre og en indre drev. De to drev berøre ikke hinanden - koblingen virker via kontaktfri overførsel af magt, hvilket betyder at den magnetiske løsning - i modsætning til traditionelle løsninger - er Vedligeholdelsesfri.

Magnetic couplings consist of an outer and an inner drive. The two drives do not touch each other – the coupling works via the non-contact transfer of power, which means that the magnetic solution – in contrast to traditional solutions – does not experience any wear. The magnetic coupling is thus maintenance-free.



M serie af magnetkobling

+ ansigts kobling designen + vedligeholdsfri

M series of magnetic coupling

+ face coupling design + maintenance free

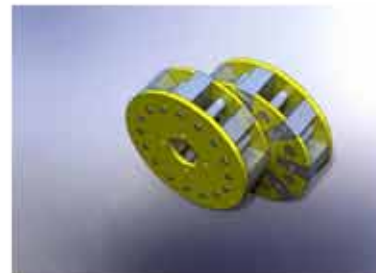

M serie af magnetkobling

+ Specielt designe af magnet kobling, efter kundensønske og opgave

M series of magnetic coupling

+ Specifically design of magnet coupling, according to customer requirements



M serie af magnetkobling

+ Eksempel på en konstruktionstegning

M series of magnetic coupling

+ Example of a construction drawing

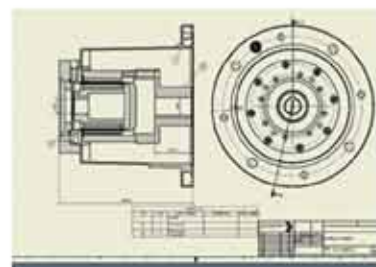

PRODUKTER:

TECHNOFLEX ©

SPIDEX®-den elastiske kobling

+ Torisonal – elastisk + dæmpning + Aksial stikbar + Sikker mod nedbrud + Ingen vedligeholdelse

SPIDEX®- the elastic coupling

Torsional elasticity + Damping + Axial pluggable + Safe against breakdown + No maintenance

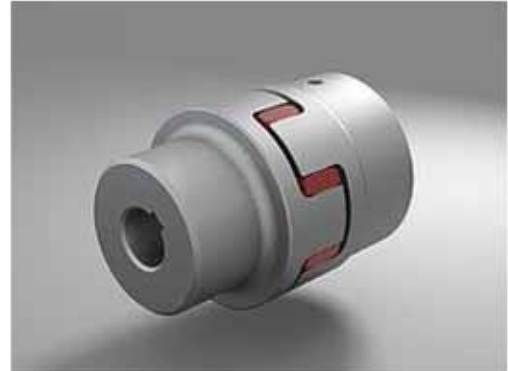

DENTEX®- den fleksible kobling

+ Kompenserer fejljusteringer + Hurtig og nem montering + Høj termisk stabilitet + Ingen vedligeholdelse + Isolerende egenskaber

DENTEX®- the flexible coupling

Compensates misalignments + Quick and easy assembly + High thermal stability + No maintenance + Insulating properties



DENTEX®FL - stive flangekoblinger

+ Minimal indbygningslængde + Blind samling + Ingen vedligeholdelse + Varmebestandig op til 120 ° C + Høj torsionsstivhed

DENTEX®FL - rigid flange couplings

+ Minimum mounting length + Blind assembly + No maintenance
Heat resistant up to 120°C + High torsional stiffness



Torsionskoblinger -Type LF

+ Fejlsikker drift + Ingen vedligeholdelse + Blind samling + Diverse materialer + Lav vægt

Torsional couplings - Type LF

+ Fail-safe operation + No maintenance + Blind assembly
+ Various materials + Low weight



PRODUKTER:

TECHNOFLEX ©

Torsionskoblinger - Type LK

+ Lav vægt + Lang levetid + Ingen vedligeholdelse +
Serie til SAE-flyhjul + Høj torsionsstivhed

Torsional couplings - Type LK

+ Low weight + Long service life + No maintenance +
Series for SAE-flywheels + High torsional stiffness



Diskkoblinger - Lovejoy Serie D

+ Ingen smøring + Ingen sliddele + Torsionelt stiv +
Uden backlash + Høj effektdensitet

Disc couplings - Lovejoy Series D

+ No lubrication + No wearing parts + Torsionally rigid +
Without backlash + High power density



HERCUFLEX® - gearkoblingen

+ Store bore dimensioner + Højt drejningsmoment +
Førsteklasses forseglingsystem + special typer + Høj forskydning

HERCUFLEX® - the gear coupling

+ Large bore dimensions + High torque + Top-class seal system +
Special types + High misalignments

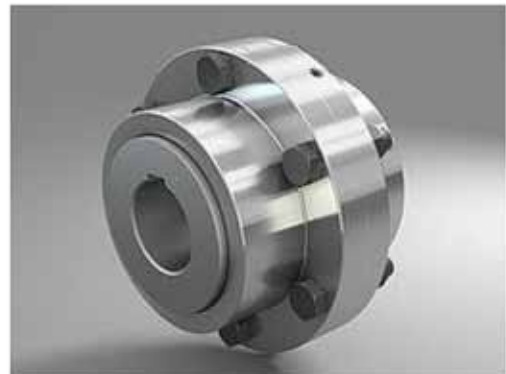

PRODUKTER:

TECHNOFLEX ©

Fodbøjler - PTFL og PTFS

+ Lagerreduktion til motorer, ramme IM B5 / V + Enkel motor udveksling + Duktilt jern til tunge applikationer

Foot Brackets - PTFL and PTFS

+ Storage reduction to motors, frame IM B5/V + Simple motor exchange + Ductile iron for heavy duty applications

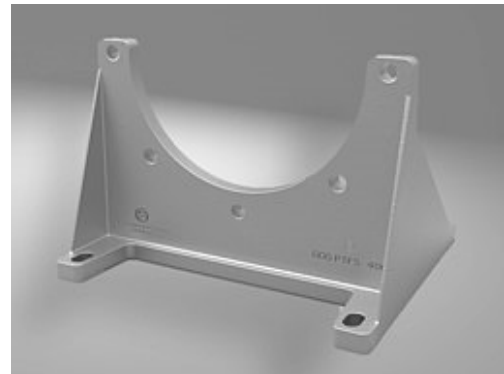

Klokke- hus

+ for hver specifik opgave + Stort udvalg af typer +
+ Materialer Al / GG / ST + Valgfri mellemflanger + Design ifølge VDMA 24 561

Bellhousings -

+ for each specific task + Wide variety of types + Materials Al/GG/ST
+ Optional intermediate flanges + Design according to VDMA 24 561

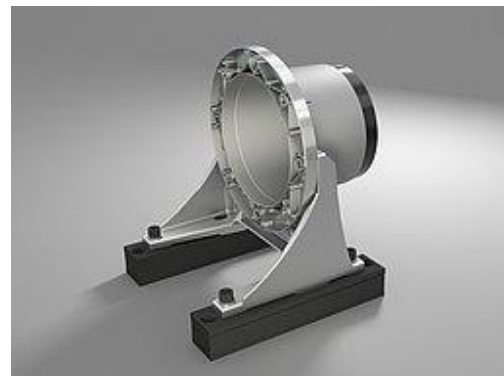

Køle-hus- Serie KPV

+ Design acc. VDMA 24 561 + Dampede versioner + Nem udskiftning
+ Pladsbesparende + Tryk op til 16 bar

Cooler bellhousings- Series KPV

+ Design acc. VDMA 24 561 + Damped versions + Easy replacement
+ Space-saving + Pressure up to 16 bars



PRODUKTER:

TECHNOFLEX ©

Ståltanke - individuel konstruktion

- + Høj kvalitet til en rimelig pris + Mange års erfaring
- + Hurtig og pålidelig levering + Kunde specificeret fremstilling

Steel tanks - individual construction

- + High quality at a fair price + Many years of experience
 - + Fast, reliable delivery + Customer specified manufacturing
-



ATEX zoner - portefølje

- + Retningslinje 2014/34 / EU
- + SPIDEX® + DENTEX® + HERCUFLEX® + Diskkoblinger

ATEX zones - portfolio

- + Guideline 2014/34/EU
 - + SPIDEX® + DENTEX® + HERCUFLEX® + Disc couplings
-

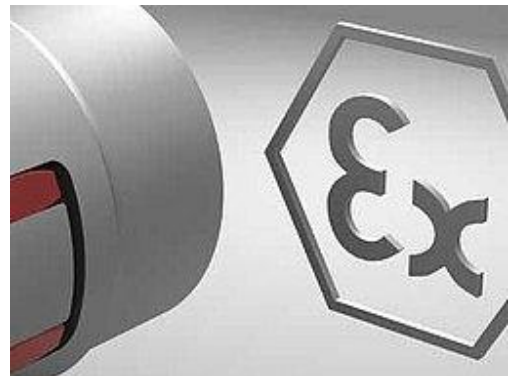

Notat:

PRODUKTER:

TECHNOFLEX ©

Ståltanke - individuel konstruktion

+ Høj kvalitet til en rimelig pris + Mange års erfaring
+ Hurtig og pålidelig levering + Kunde specificeret fremstilling

Steel tanks - individual construction

+ High quality at a fair price + Many years of experience
+ Fast, reliable delivery + Customer specified manufacturing



ATEX zoner - portefølje

+ Retningslinje 2014/34 / EU
+ SPIDEX® + DENTEX® + HERCUFLEX® + Diskkoblinger

ATEX zones - portfolio

+ Guideline 2014/34/EU
+ SPIDEX® + DENTEX® + HERCUFLEX® + Disc couplings

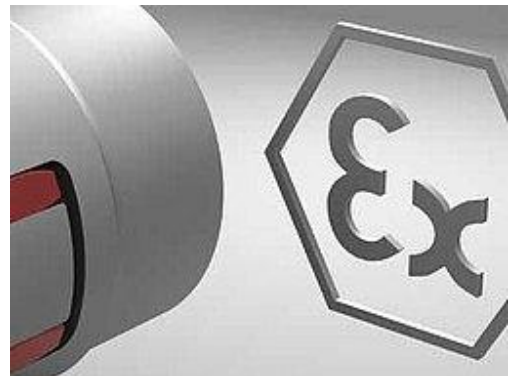

Notat:

PRODUKTER:

TECHNOFLEX ©

ARCUSAFLEX

Meget fleksibel gummi - disk - koblinger til forbrændingsmotorer

ARCUSAFLEX

Highly flexible rubber - disc - couplings for internal combustion engines



ARCUSAFLEX-VSK

Meget fleksible, torsions bløde koblinger til kardanaxsel montage

ARCUSAFLEX-VSK

Highly flexible, torsionally soft couplings for universal joint shaft mounting



TOK-koblingssystem

Meget fleksibelt koblingssystem, der finder anvendelse på diverse testbænke

TOK-coupling system

Highly flexible coupling system applicable on miscellaneous test benches



MULTI MONT OCTA

Fleksibel svinghjuls kobling til stationære enheder med forbrændingsmotor

MULTI MONT OCTA

Flexible flywheel coupling for stationary units with combustion engine drive



PRODUKTER:

TECHNOFLEX ©

MULTI MONT SELLA

Fleksible eller elastiske klokobliger med bremseskiven eller bremsetromlen, fejlsikker design

MULTI MONT SELLA

Torsionally flexible claw couplings with brake disc or brake drum, fail-safe design



MMS-HS

Torsionelt fleksible klokobliger til højhastighedsapplikationer, lav vægt

MMS-HS

Torsionally flexible claw couplings for high-speed applications, low weight



MULTI CROSS FORTE

Meget fleksibel konstruktion kompenserer store aksel forskydninger, modularitet

MULTI CROSS FORTE

Highly flexible construction compensating major shaft displacements, modularity



PRODUKTER:

TECHNOFLEX ©

MULTI CROSS RILLO

Meget fleksible dæk koblinger med koniske bøsning, stød og vibrationsdæmpning

MULTI CROSS RILLO

Highly flexible tyre couplings with taper bushes, shock and vibration damping



REIBO

Fleksibel pin-kobling med bremseskive eller bremsetromle, vedligeholdelsesfri og fejlsikker

REIBO

Flexible pin-type coupling with brake disk or brake drum, maintenance-free and fail safe



RCT

Torsionelt stive flangekoblinger til pumpedrev, vedligeholdelsesfri

RCT

Torsionally stiff flange couplings for pump drives, maintenance-free



PRODUKTER:

TECHNOFLEX ©

Centrifugalkoblinger

Centrifugalkoblinger er konstrueret til at give en "soft-start" eller "no-load" acceleration til køremaskinen ved opstart, de tillader også føreren at gå i tomgang uden last og uden at køre det drevne udstyr.

Centrifugal Clutches

Centrifugal clutches are designed to provide a "soft-start" or "no-load" acceleration for the driving machine on start up, they also allow the prime mover to idle without load and without driving the driven equipment.



Hydrauliske koblinger

Den hydraulisk koblinger anvendes primært som indgreb eller frigøres forbindelse mellem kraftenheder og arbejdsenheder (e. G. Mellem gear og pumpe) eller i lignende indbygningssituationer. Indgreb eller frakobling udføres ved hjælp af hydraulikforsyningen i systemet.

Hydraulic clutches

The hydraulically clutches are primarily used as engageable or disengageable connection between power units and working units (e. g. between gearbox and pump) or in similar installation situations. The engagement or disengagement is carried out by means of the hydraulic supply within the system.



Linnig elektromagnetisk kobling, til brug for PTO eller lignende applikationer, kan bygges sammen med flexkoblinger.

Linnig electromagnetic clutch, for use by the PTO or similar applications can be built with Flex couplings



PRODUKTER:

TECHNOFLEX ©

HUEGLI TECH er en Producent, ingeniørvirksomhed og grossist med kernekompetencer i Engine Governing Systems, Generator Sæt panel, motorstart løsning, Gas motor- System, Motor Tilbehør og Dual Brændstof Konverteringer.



HUEGLI TECH is a Manufacturer, Engineering company and Wholesaler with core competences in Engine Governing Systems, Generating Set Controls, Engine Starting Solutions, Gas Engine Management System, Engine Accessories and Dual Fuel Conversions.

AXCES har en bred vifte, der dækker alle applikationer og motorstørrelser. Disse lyddæmpere er opdelt i serie afhængigt af applikationen, dæmpningsteknikken og de ønskede dæmpningsniveauer.



AXCES has a wide range that covers all applications and engine sizes. These silencers are divided in series depending on the application, damping technique and the desired damping levels.

Technoflex sensorer med og uden godkendelse af klassifikationselskaber
+ Intelligente analoge tank sensorer + Temperaturfølere



Technoflex sensors with and without approval by classification societies
+ Intelligent, analogue tank sensors + Temperature sensors

Roth hydrauliske akkumulatorer har stået for erfaring i forskning, udvikling, design i produktion af stempel, blære og membran akkumulatorer.



Roth hydraulic accumulators have stood for experience in research, development, design in the production of piston, bladder and

PRODUKTER:

TECHNOFLEX ©

KØLER *Innovative og kundeorienterede systemer dikterer morgendagens marked. Dette er det princip, som Universal Hydraulik har fulgt i at design af hydrauliske systemer, kølesystemer og varmevekslere, der anvendes over hele verden i alle anvendelsesområder.*

COOLER *Innovative and customer oriented systems dictate tomorrow's market. This is the principle that Universal Hydraulics has followed in the design of hydraulic systems, cooling systems and heat exchangers used worldwide in all applications.*

ACN og DCN - de kompakte kølere

+ Kompakt design + Høj kølekapacitet + Højt arbejdstryk
+ Lavt tryk tab + Tilgængelig acc. ATEX 94/9 / EG

ACN and DCN - the compact coolers

+ Compact design + High cooling capacity + High operating pressure
+ Low pressure loss + Available acc. ATEX 94/9/EG

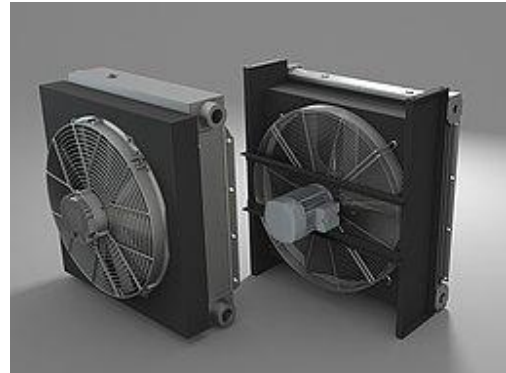

BNZ og B(T)U - Rør kølere

+ Kompakt design + Lavt tryk tab + Integrerede testporte +
+ Kølekapacitet op til 500kW + Flowhastighed op til 850 l / min

BNZ and B(T)U - Tube stack coolers

+ Compact design + Low pressure loss + Integrated test ports
+ Cooling capacity up to 500kW + Flow rate up to 850 l/min



PRODUKTER:

TECHNOFLEX ©

UKC - til montering i tanke

+ Effektiv afkøling + Ekstremt kompakt + Billig løsning
+ Køleoverflade 0,15 - 0,43m² + Nem montering

UKC - for mounting in tanks

+ Efficient cooling + Extremely compact + Inexpensive solution
+ Cooling surface 0,15 - 0,43m² + Easy assembly



OCN - offline køleenheder

+ Kompakt design + Høj kølekapacitet + Effektive motorer
+ Lavt støjniveau + Integreret pumpe

OCN - offline cooling units

+ Compact design + High cooling capacity + Efficient motors
+ Low noise level + Integrated pump



Pladevarmevekslere - serie PK

+ Arbejdstryk op til 30 bar + Temperatur op til 195 °C
+ Maksimalt 300 plader + forskellige konsoller
+ Særlige versioner på forespørgsel

Plate heat exchangers - series PK

+ Working pressure up to 30bar + Temperatur up to 195 °C
+ Maximal 300 plates + Various brackets
+ Special versions on demand

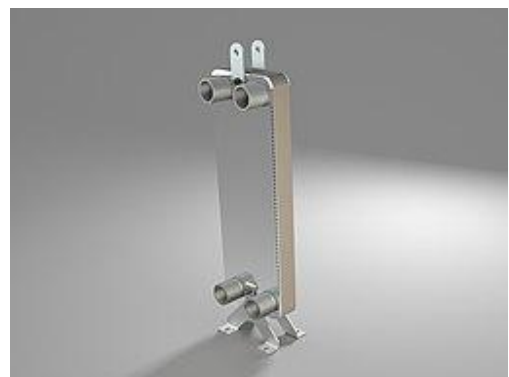

SEEKING PARTNER:



MADE IN DENMARK

TECHNOFLEX
POWER TO PERFORM



TECHNOFLEX®

Industrivej 21

DK-8653 Them

tlf. +45 8724 4545

www.technoflex.dk