



VERKTØY A-S  
INDUSTRI

# Simson

**SIMSON** KOMPAKT



# SIMSON KOMPAKT JACKS

SIMSON KOMPAKT HEBER

SIMSON KOMPAKT DOMKRAFTER

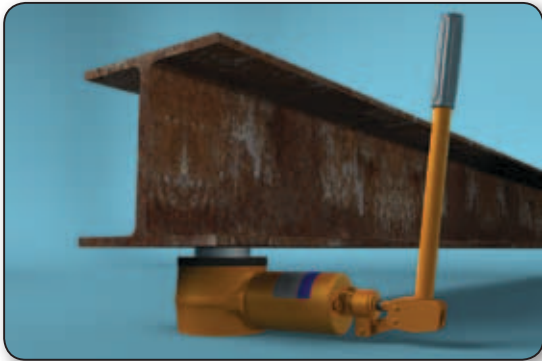

Lifting

Heben

Lyfta

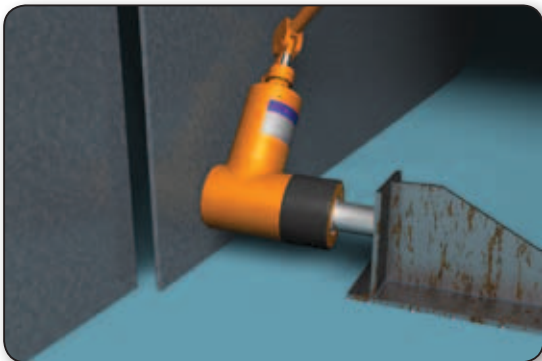

Pushing

Drucken

Trycka

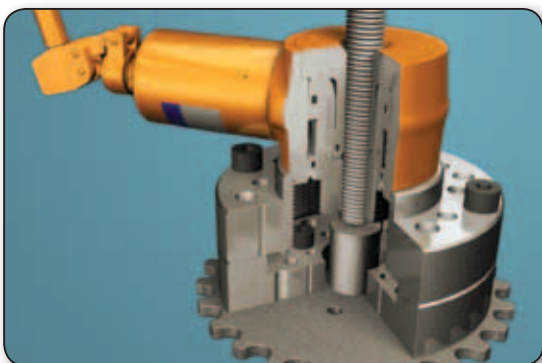

Pulling

Ziehen

Dra

# UNIQUE FEATURES

EINZIGARTIGE EIGENSCHAFTEN

UNIKA EGENSKAPER

- **Simson Kompakt is a hydraulic powerpack**  
that combines a number of unique features, such as lightweight, attractive design and high capacity. Quality and reliability are two other characteristics that have made Simson a favourite tool among professionals worldwide.
- **Simson Kompakt ist ein hydraulisches Kraftpaket,**  
das sich durch mehrere vorteilhafte Eigenschaften auszeichnet: niedriges Gewicht, kompaktes Design und hohe Kapazität. Qualität und Zuverlässigkeit sind Schlüsselbegriffe, die man bei den Simson-Produkten bereits voraussetzt und die von Fachleuten in der ganzen Welt geschätzt werden.
- **Simson Kompakt är ett hydrauliskt kraftpaket**  
som förenar en rad unika egenskaper. Låg vikt, smäcker design och hög kapacitet är utmärkande kännetecken. Kvalitet och pålitlighet är två andra nyckelbegrepp som gjort Simson till ett uppskattat verktyg av yrkesfolk över hela världen.



*The model shown is 2325H with centre hole  
Das Modell wird hier 2325H mit Zentrum-Loch  
Visad modell är 2325H med genomgående hål*

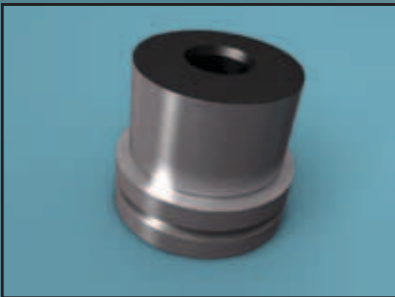

- Lift piston of tempered premium stainless steel.
- Hubkolben aus gehärteten hochwertigsten korrosionsbeständigen Stahl.
- Lyftkolv av härdat höghållfast, korrosionsbeständigt stål.



- Roller polished cylinder of high strength materials
- Rollpolierter Zylinder aus hochfesten Material
- Rullpolerad cylinder i höghållfast material



- External thread facilitates setting of the cylinder.
- Außengewinde vereinfacht das Fixieren von Zylinder.
- Utvändig gänga förenklar fixering av cylindern.



- Dimensioned for 3-fold safety against overloading and 4-fold security against breaks.
- Dreifach-Schutz gegen Überlastung und Vierfach-Schutz gegen Bruch.
- Dimensionerad för 3-faldig säkerhet mot överbelastning och 4-faldig säkerhet mot brott.



- All jacks feature a safety valve on the pump side of the circuit that releases at 825 bar.
- Alle Simson-Hydrauliker sind auf der Pumpenseite mit einem Sicherheitsventil versehen, das bei 825 bar zuverlässig auslöst.
- Alla domkrafter har säkerhetsventil på pumpsidan som bryter vid 825 bar.



- Closed hydraulic system ensures perfect operation of the jack in all situations – even submersed.
- Der geschlossene Hydraulikkreislauf läßt den Heber in allen Lagen und Situationen einwandfrei arbeiten – auch unter Wasser.
- Slutet hydraulsystem gör att domkraften fungerar perfekt i alla lägen – även under vatten.



- Optional manometer
- Manometer option
- Manometeroption



- Working pressure 825 bar
- Betriebsdruck 825 bar
- Arbetstryck 825 bar

# Simson



- Handles push and pull operations for stretching cables, rods, bolts, etc. and the drawing off bearings, sleeves, etc.
- Bewältigt Zug- und Druckarbeiten, z.B. beim Spannen von Kabeln, Stangen, Bolzen usw. sowie Abziehen von Lagern, Buchsen usw.
- Klarar tryck- och dragoperationer vid exempelvis spänning av kablar, stänger, bultar etc samt avdragning av lager, hylsor etc.

Simson is delivered with a three-year operating and material warranty on the piston and the cylinder.

Die Simson-Heber werden mit dreijähriger Material- und Verarbeitungsgarantie für Kolben und Zylinder geliefert.

Simson levereras med tre års arbets- och materialgaranti på kolv och cylinder.



# JACKS WITH HOLLOW PISTON (H & HG models)

HYDRAULIKHEBER MIT HOHLKOLBENZYLINDER (H & HG MODELLE)

DOMKRAFTER MED HÅLKOLV (H- & HG-MODELLER)

825 bar

10-113 ton

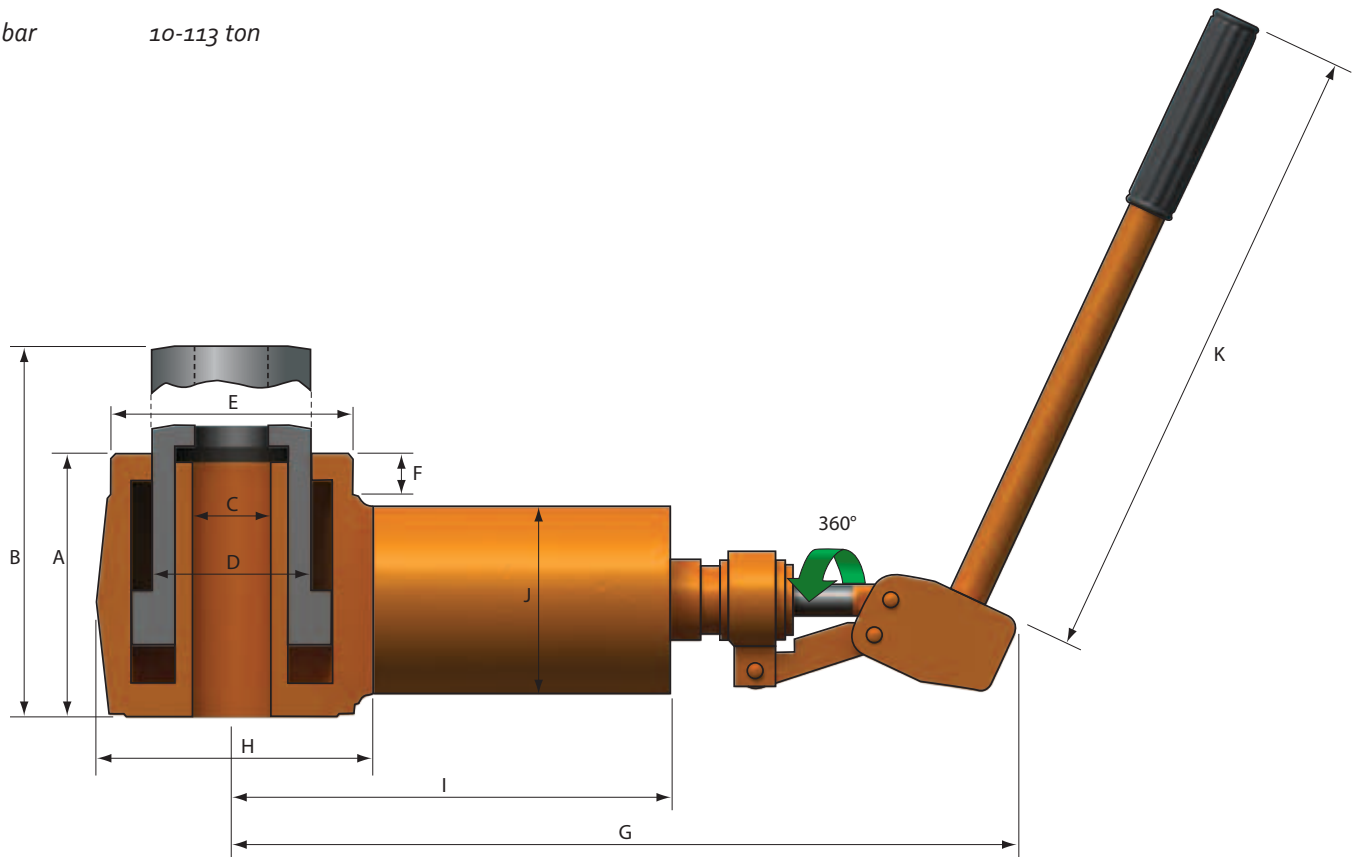

Capacity *	Stroke	Model	Area	A	B	C	D	E	F	G	H	I	J	K	Weight
ton (kN)	mm	SIMSON	cm <sup>2</sup>	mm	mm	mm	mm	mm	mm	mm	mm	mm	mm	mm	kg
10 (100)	30	1030H	13,47/ 12,57	73	104	16,5/ 20,5	40	-	-	230	70	127	60	262	3,6
	30	1030HG	13,47/ 12,57	84	115	M16/ M20	40	-	-	230	70	127	60	262	3,7
	50	1050H	12,57	100,5	150	20,5	40	M 70x3	30	230	70	127	60	262	3,9
	50	1050HG	12,57	110,5	161	M20	40	M 70x3	30	230	70	127	60	262	4,0
	75	1075H	12,57	132,5	205	20,5	40	M 70x3	45	230	70	127	60	262	4,7
	75	1075HG	12,57	142,5	215	M20	40	M 70x3	45	230	70	127	60	262	4,8
22 (220)	75	2175H	28,27	130	205	30,5	60	M 90x3	20	276	105	175	98	262	10,4
	75	2175HG	28,27	172,5	247	M30	60	M 90x3	20	276	105	175	98	262	10,5
22,5 (225)	25	2325H	28,30	79,5	104	24,5	60	M 90x3	14	244	98	141	60	262	5,5
	25	2325HG	28,30	103,5	134	M24	60	M 90x3	14	244	98	141	60	262	5,8
43 (430)	55	4355H	54,79	130	185	40,5	80	M 120x3	20	288	135	185	98	262	13,6
	55	4355HG	54,79	177	232	M39	80	M 120x3	20	288	135	185	98	262	13,8
113 (1130)	50	11650H	144,51	134	184	56,0	100	M 200x4	25	305	202	202	98	262	37,0

xxxxH = Without threaded hole / Hohlkolbenzylinder ohne Innengewinde / Utan gängat hål

xxxxHG = With threaded hole / Hohlkolbenzylinder mit Innengewinde / Med gängat hål

 SolidComponents™

\* Calculated with 95% efficiency – 825 bar / Berechnet mit 95% Wirkungsgrad – 825 bar / Beräknat med 95% verkningsgrad – 825 bar

# JACKS WITH SOLID PISTON

HYDRAULIKHEBER MIT VOLLKOLBEN

DOMKRAFTER MED SOLID KOLV

825 bar

15-150 ton

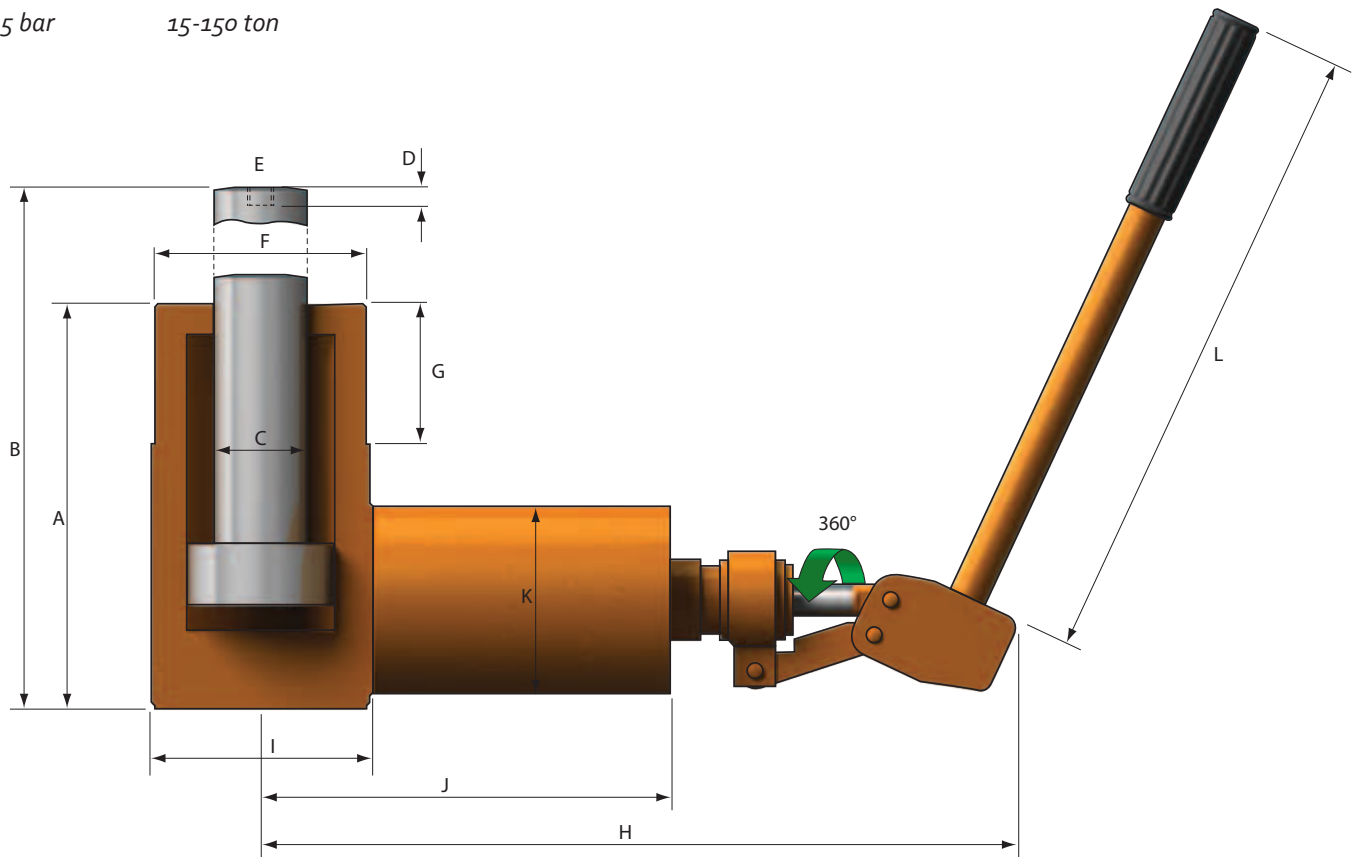

Capacity *	Stroke	Model	Area	A	B	C	D	E	F	G	H	I	J	K	L	Weight	
ton	(kN)	mm	SIMSON cm <sup>2</sup>	mm	mm	mm	mm	mm	mm	mm	mm	mm	mm	mm	mm	kg	
15	(150)	30	1530	19,63	74	104	40	25	M 12	-	-	230	70	127	60	262	3,7
		50	1550	19,63	100	150	40	23	M 12	M 70x3	30	230	70	127	60	262	4,4
		75	1575	19,63	133,5	205	30	20	M 8	M 70x3	45	230	70	127	60	262	5,0
		75	1575B**	19,63	164,5	237	30	-	M 8	M 70x3	45	230	70	127	60	262	5,8
30	(300)	30	3030	38,48	79	109	40	25	M 12	M 90x3	14	244	98	141	60	262	5,5
34	(340)	75	3475	44,17	130	205	60	35	M 16	M 90x3	20	276	105	175	98	262	11,1
61,5	(615)	55	6255	78,54	130	185	80	35	M 16	M 120x3	20	288	135	185	98	262	15,2
147,5	(1475)	50	15550	188,68	134	184	100	35	M 16	M 200x4	25	305	210	202	98	262	41,0

 SolidComponents™



\* Calculated with 95% efficiency – 825 bar / Berechnet mit 95% Wirkungsgrad – 825 bar / Beräknat med 95% verkningsgrad – 825 bar

\*\* Extended bottom with thread M 56x3. / Mit verstärktem Boden und Anschlußgewinde M 56x3. / F örsedd med förlängd botten med anslutningsgänga M 56x3.



# RELIABLE AND USEFUL EVERYWHERE

ZUVERLÄSSIG UND HILFREICH ÜBERALL  
PÅLITLIG OCH ANVÄNDBAR ÖVERALLT





-  *In the offshore industry*
-  *In der Offshore-Industrie*
-  *Inom offshore-industrin*





-  *In ship yards*
-  *Auf Werften*
-  *Inom varvsindustri*





-  *In mining industry*
-  *Im Bergbau*
-  *Inom gruvindustrin*





-  *In the energy sector*
-  *Im Energiesektor*
-  *Inom energisektorn*



-  *In heavy industry*
-  *In der Schwerindustrie*
-  *Inom tung industri*



-  *In wind mill industry*
-  *In der Wind-Industrie*
-  *Inom vindkraftsindustri*

