

# Guard Rails

## GUARD RAIL 90



**QUICK  
INSTALLATION  
WITH  
EXPANSION  
SCREW**



**M16  
GALVANISED STEEL**

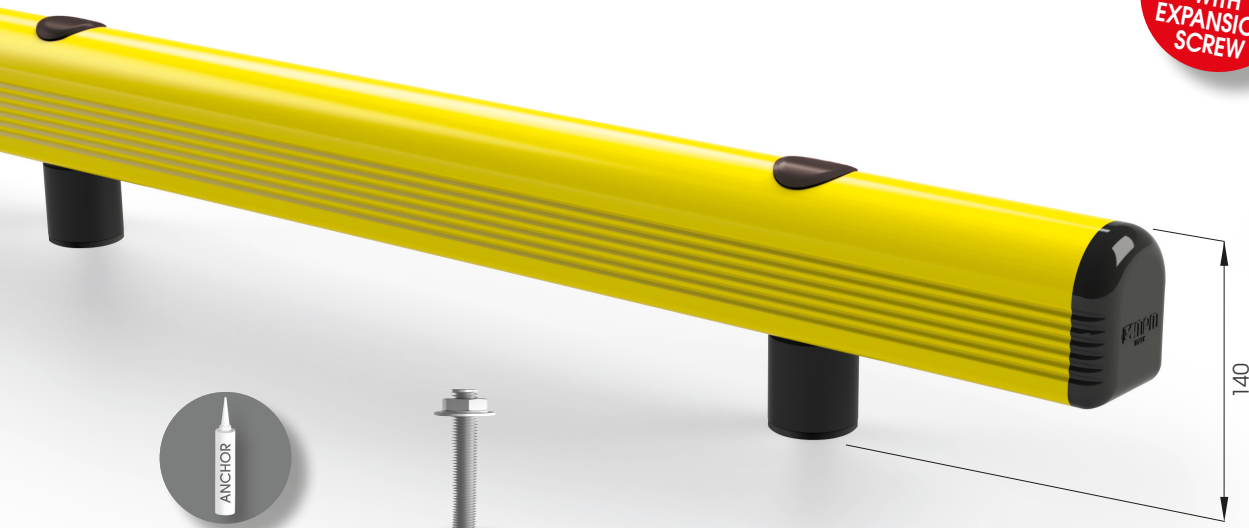

**ALTERNATIVE FIXING**  
HIGH RESISTANCE WITH RESIN



**SF16  
STAINLESS STEEL**

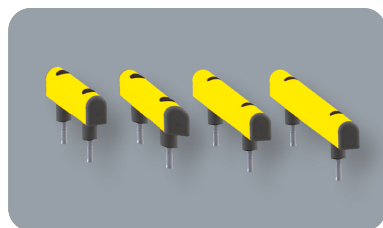

**GR 90** 500  
750  
1000  
1500

Length 500 mm  
Packing unpacked on pallet

Length 750 / 1000 / 1500 mm  
Packing 2 pz / box

Colour B M

Equipped with accessories

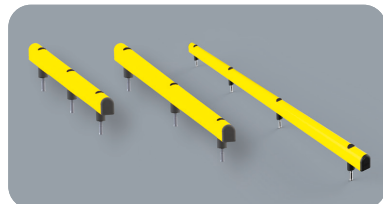
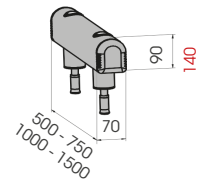

**GR 90** 2000  
3000  
4000

Length 2.000 / 3.000 / 4.000 mm  
Packing unpacked on pallet

Colour B M

Equipped with accessories

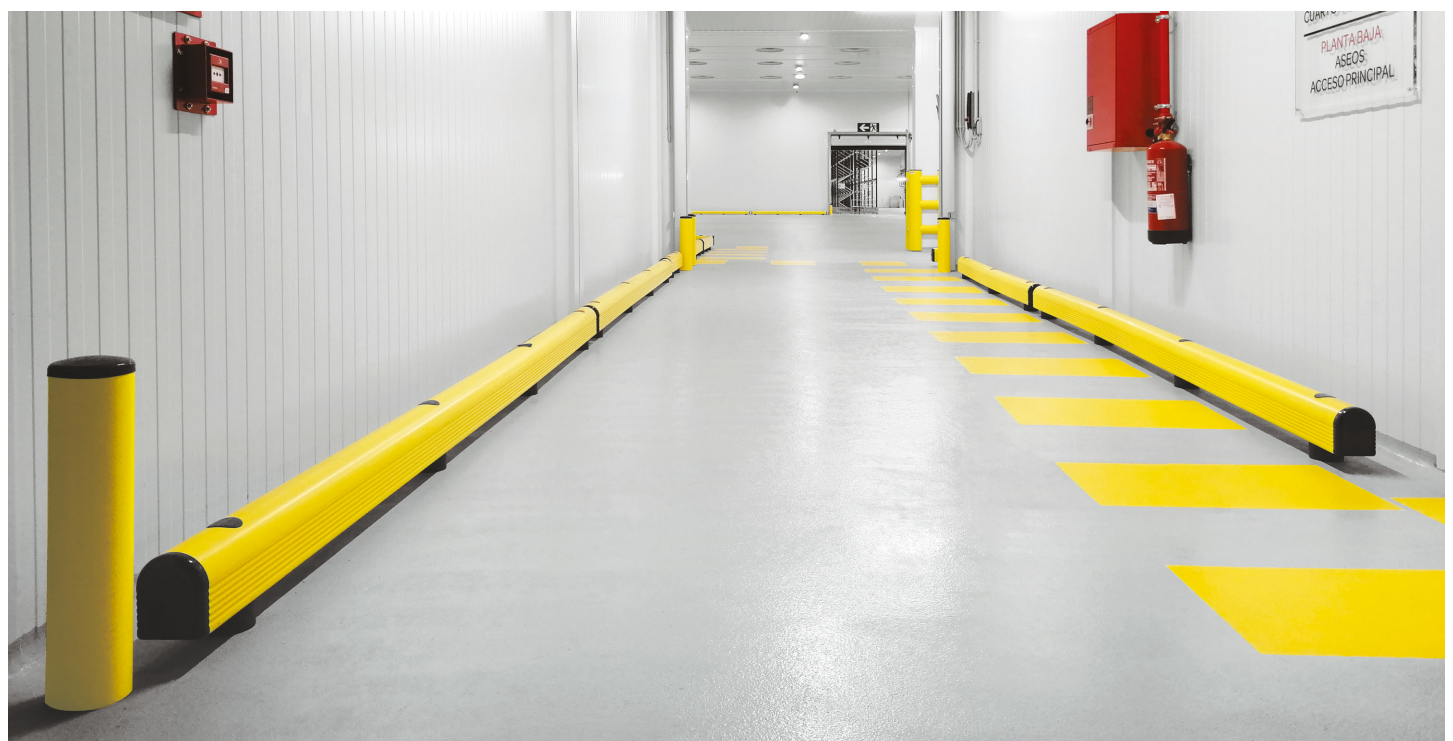
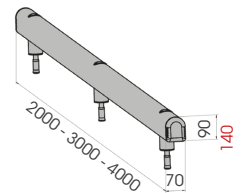

# Guard Rails

## GRIN 90

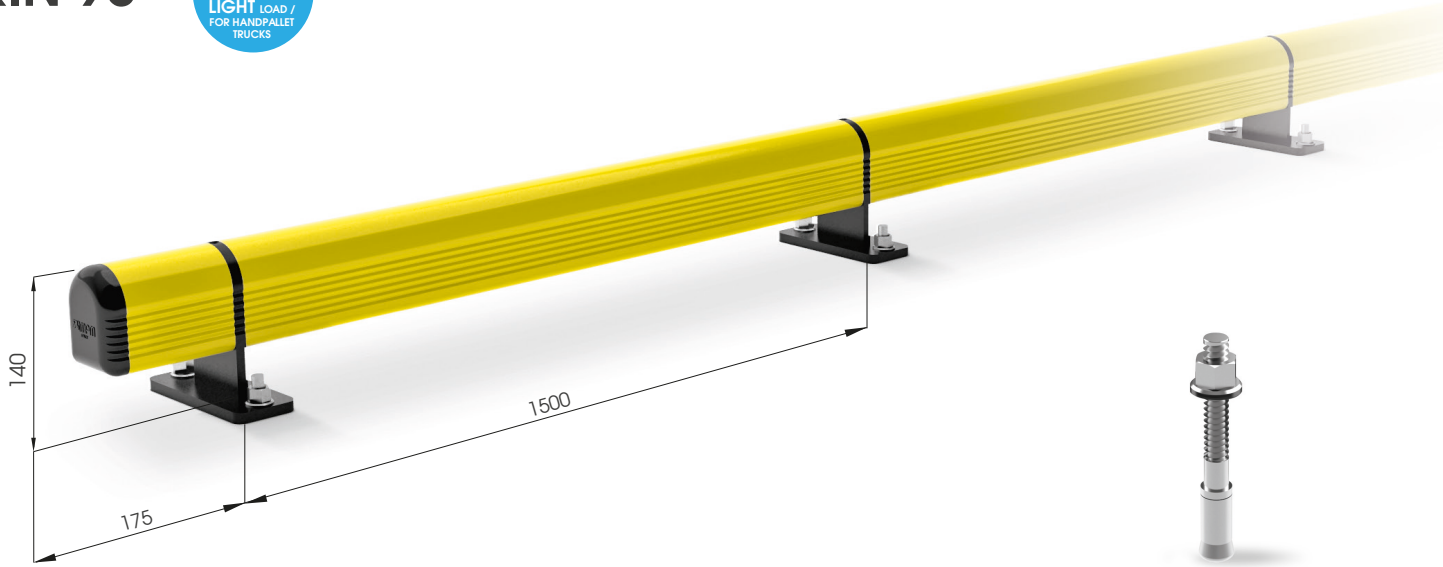

**M12  
GALVANISED STEEL**

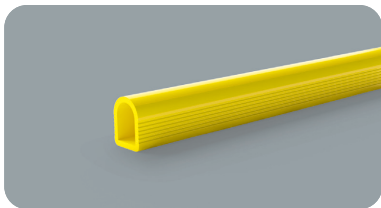

**GRIN 90 1500**

Length **1500 mm**  
Packing **to be defined**  
Colour **M**

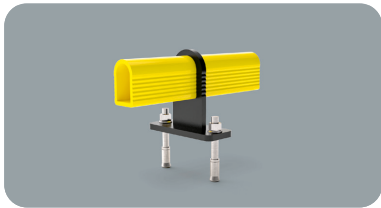
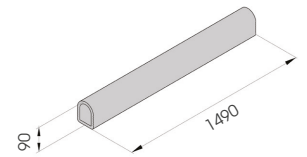

**GRINCO 90**

Packing **to be defined**  
Colour **M**

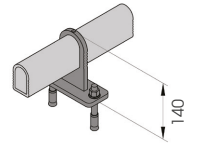

Equipped with accessories



**GRINT 90**

Packing **to be defined**  
Colour **M**

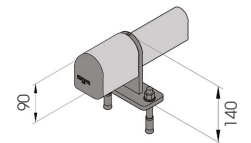

Equipped with accessories





# GUARD RAIL 150



SF20  
STAINLESS STEEL

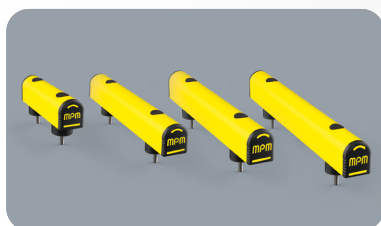
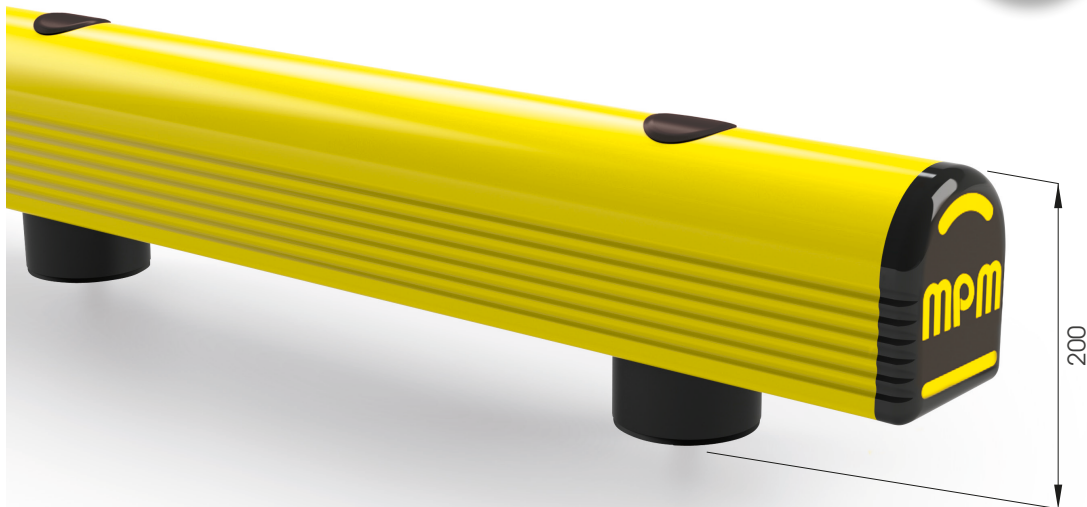

GR 150 500  
750  
1000  
1500

Length 500 / 750 / 1000 / 1500 mm  
Packing unpacked on pallet  
Colour B M

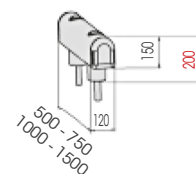

Equipped with accessories

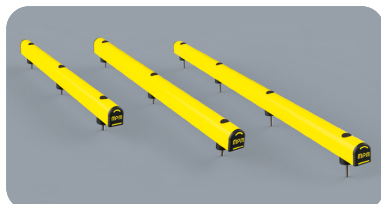

GR 150 2000  
3000  
4000

Length 2.000 / 3.000 / 4.000 mm  
Packing unpacked on pallet  
Colour B M

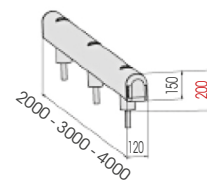

Equipped with accessories



# LINK SINGLE



DIFFERENT SIZES ON REQUEST

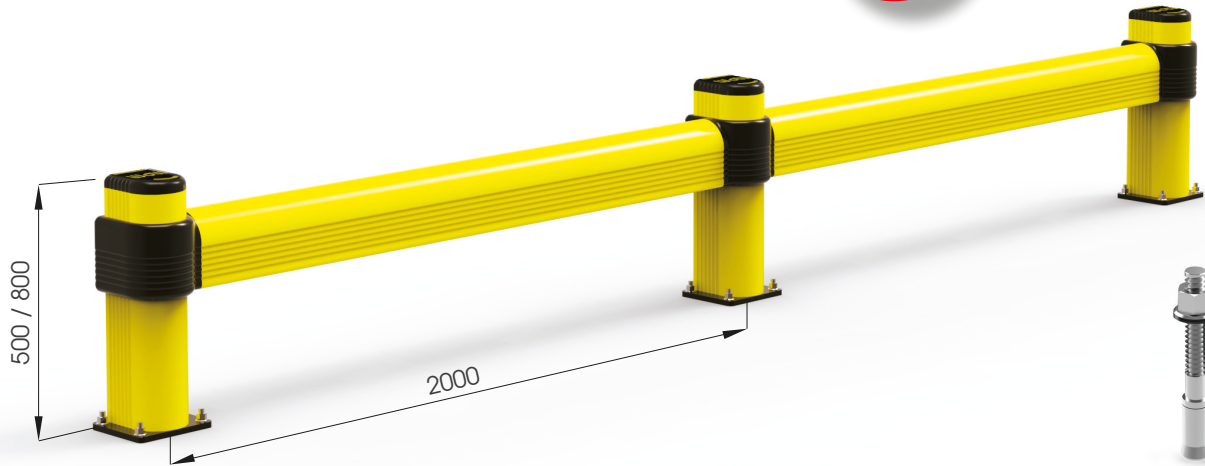

M12 GALVANISED STEEL

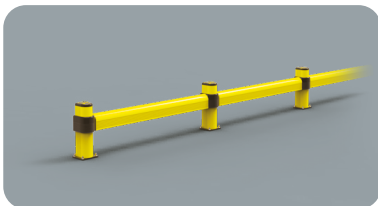

LINK SINGLE 500 800

Equipped with accessories

Packing Colour **B** **M** unpacked on pallet

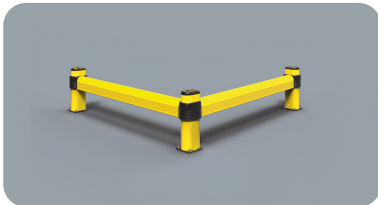
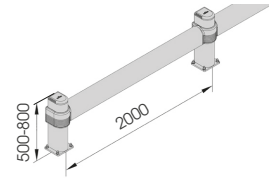

LINK SINGLE CORNER

External Corners available

Equipped with accessories

Packing Colour **B** **M** unpacked on pallet

