

2013

**iSERIES™ SYSTEM**

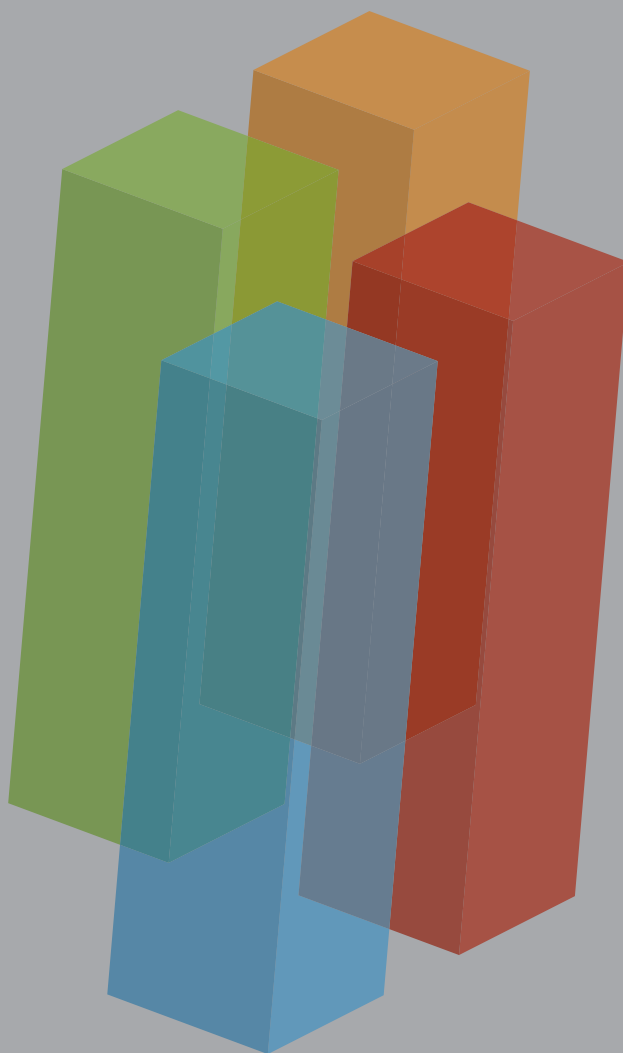

## WHAT IS ISERIES?

iSeries is a true novelty in the sector of winter and summer air-conditioning systems. It is entirely regulated by sophisticated DC Inverter electronics developed in Italy by Argoclima technicians. It is produced in Italy with the most advanced technology available for the production of electronic boards.

The use of renewable energy is at the basis of any choice regarding the iSeries system. It is the first heat pump multi-split inverter, which creates different configurations with the same outdoor unit. No more borders between air/air, air/water and mixed systems.

iSeries: designed in Europe to work all over the world!

## ARGO: HOT WATER RE-INVENTED!

With iSeries the production of domestic hot water from renewable sources becomes a reality, accessible to everyone, thanks to the new eMix and eMix Tank units.

This revolutionary discovery does not only provide hot water also when the air-conditioners are being used to cool the indoor environments, but also entirely uses all the energy that is usually dispersed into the air with normal air-conditioners. This ensures significant energy and cost savings, with advantages for the environment and your finances!

# iSERIES

## The key points

**The same units for residential and commercial applications**

**The same outdoor units for Mono and Multi split  
70% fewer references to manage**

**Flexible combination of direct expansion and hydronic  
Domestic hot water always available, also while cooling**

**Wide range of air to air outdoor units, including  
hydrokit units for radiating floor, radiators and fan coils  
SDHV, flexible nylon ductable system**

**Operates from -32°C to +50°C**

**Highly technological inverters**

**All included**

**Designed and built in Italy**



## ARGOCLIMA, AN ITALIAN COMPANY



Argoclima is a historical Italian company established in 1929. Its history is filled with memorable achievements, such as the radiators and heaters, followed by boilers and the first window air-conditioner dating back to 1965, always keeping up with the times. Today Argoclima heads a European group that comprises three companies, all engaged in air-conditioning and heating from renewable sources.

Argoclima develops and manufactures its products in Gallarate (VA), Italy, a few kilometres from the Milano Malpensa international airport, and in France, near Lyon, with distributions worldwide through the logistic centre purposely located near Brescia.

The Argoclima group's marketing department and laboratories constantly focus on the search for and development of state-of-the-art solutions that generate high-quality products that are well designed and very comfortable for service and use by end users. The design of the Technibel brand products is complemented by an important activity of development and production on the behalf of third parties targeting international OEM brands and companies. The company offers constant technical training and support to all its customers, and particularly to all its valued installers, who play a major role in the success of any installation, as a fundamental element of the quality perceived by the end users, whether these are families, companies, factories, shopping centre etc.

In its sector the Technibel brand is now a synonym with European production, quality and reliability over time and features and excellent portfolio of products and systems that meet a multitude of needs for the integrated air-conditioning and heating service in residential, service and business applications.

# iSERIES™ APPLICATIONS

# iSERIES™

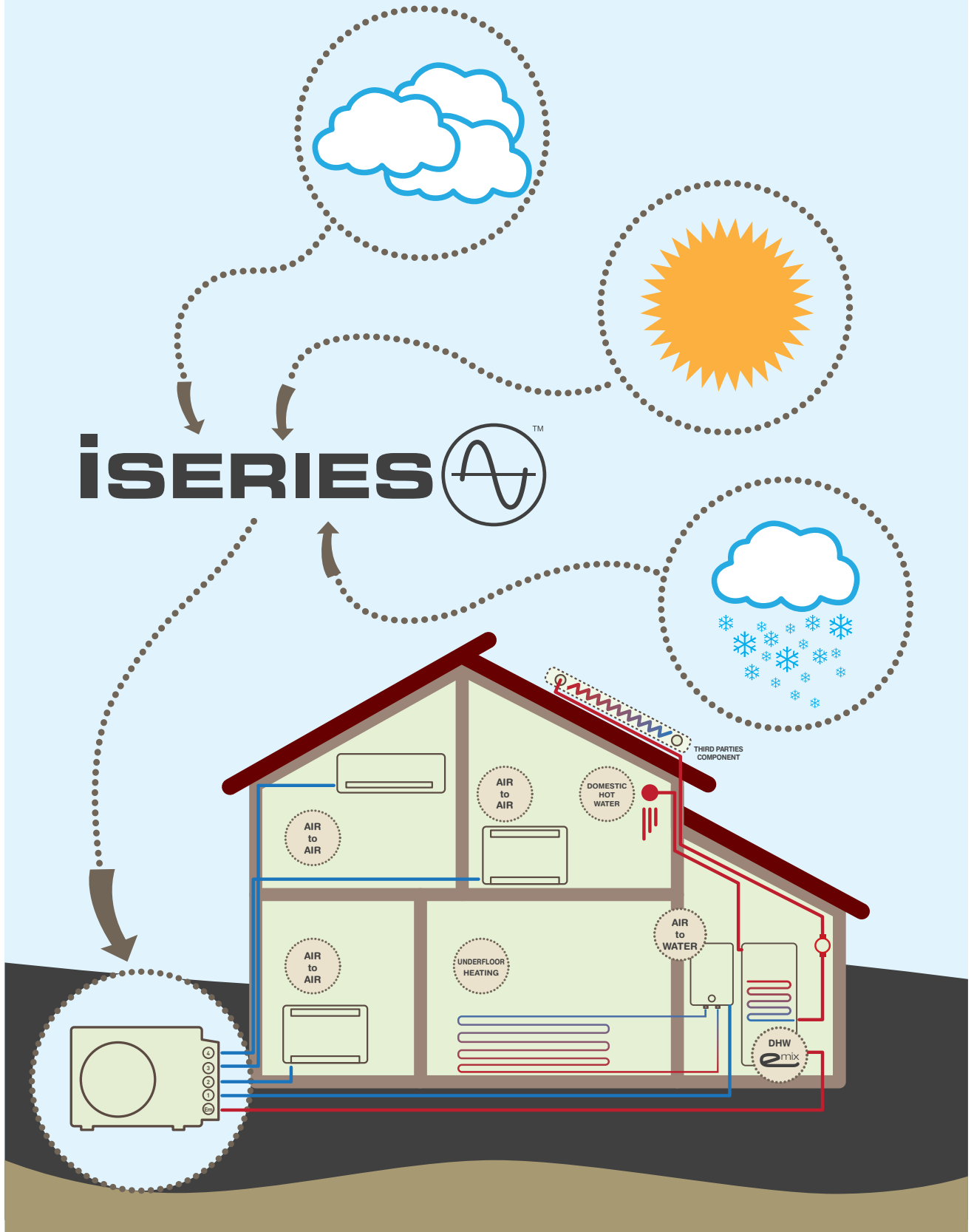

# iSERIES™ RANGE

iSERIES™ is a split system with a feature that has never been seen before: the same outdoor units are both mono and multi, they do not change based on the application and are compatible with all the indoor units in the iSERIES™ range. Six outdoor units are available to satisfy the needs of the most demanding customers, covering a modulated heat output range from 0.6 kW to over 13 kW; the range will be further extended up to over 22 kW.

## RANGES AND USAGE TYPES NEW

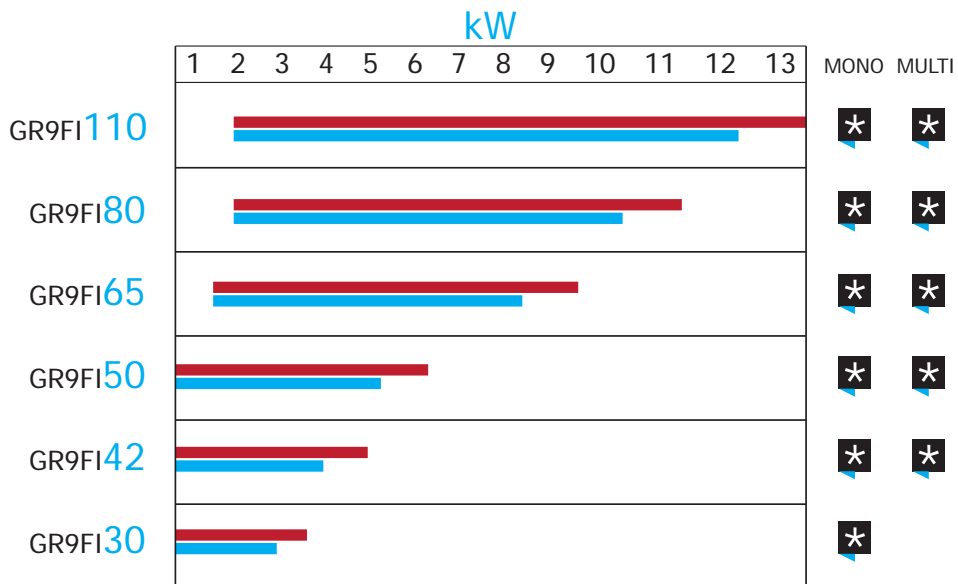

## iSERIES™ RANGE

The indoor units in the iSERIES™ range are divided into categories by power output and by application.

There are four power output categories:

- size A for heating up to 4 kW
- size B for heating up to 7 kW
- size C for heating up to 11 kW
- size D for heating up to 14 kW

Thanks to the iSERIES™ sophisticated inverter regulation system, the classic references of rated power outputs are replaced by a greater flexibility and the number of product codes and references is reduced by 70%.

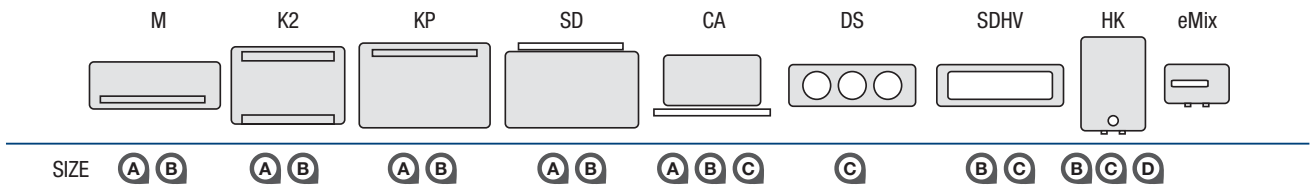

\* During 2013, KP size C and CA, DS, SDHV size D will also be available

### The application categories are:

#### Air/Air type:

- M wall mounted
- K2 two-way underfloor
- KP underfloor - reversible for ceiling mounting
- SD underfloor - reversible for built-in ceiling mounting (slim ducted)
- CA cassette for false ceilings
- DS mono and multi-zone ductable
- SDHV high speed ductable

#### Air/Water type:

- HK Hydrokit for underfloor systems, radiators and fan coils
- eMix for domestic hot water

Great flexibility in the combination of different types and categories of indoor units allows many different applications to be realised that before required the use of different systems that were difficult to integrate with one another.

**Air/air mono-split**, from a typical high quality residential split unit system to solutions for small service sector applications, offices, restaurants, bars... also multi-zone systems with ductable units... or for special applications such as containers, motor homes...

**Air/air multi-split**, a classic solution for the summer air conditioning of apartments and villas but also for heating and cooling offices, shops and small service sector applications in general.

**Air/water mono-split**, this solution is commonly used for heating and cooling with underfloor systems, but can also be used with low temperature radiators or fan coils, even in combined and multi-zone combinations.

**Air/water multi-split mixed with air/air**, a new solution that offers a wide spectrum of applications. With this system we can create a underfloor system with two zones and at the same time air condition a cellar and loft conversion with an air/air unit suited to these spaces: wall mounted, underfloor with two-way flow or maybe even ductable.

**Domestic hot water**, the revolutionary eMix and eMix tank units make it now possible to produce domestic hot water 365 days a year in any operating mode, for both heating and cooling. The function for the production of hot water while the system is in cooling mode is extremely innovative

iSERIES™ is a primary and integrated system for heating, air conditioning, air treatment and domestic hot water production, entirely based on a sophisticated technique employing high efficiency inverter heat pumps, a renewable energy source that can be combined with thermal and photovoltaic solar power.

The flexibility of the iSERIES™ system satisfies the requirements of the residential market and small service sector applications: from the simplest high quality split unit systems to multi-zone systems with underfloor systems, to multi-split systems for apartments, offices and public spaces...



**Outdoor Units**



**Indoor Units**

	GR9FI30EMX	GR9FI42EMX	GR9FI50EMX	GR9FI65EMX	GR9FI80EMX	GR9FI110EMX	Wall	Floor	Floor/Ceiling	Floor/Ceiling Built-in	Cassette	Ducted	SDHV	HydroKit	eMix / eMix Tank
--	------------	------------	------------	------------	------------	-------------	------	-------	---------------	------------------------	----------	--------	------	----------	------------------

<b>air/air mono-split</b>	<input checked="" type="checkbox"/>	<input checked="" type="checkbox"/>	<input checked="" type="checkbox"/>	<input checked="" type="checkbox"/>	<input checked="" type="checkbox"/>	<input checked="" type="checkbox"/>	<input checked="" type="checkbox"/>	<input checked="" type="checkbox"/>	<input checked="" type="checkbox"/>	<input checked="" type="checkbox"/>	<input checked="" type="checkbox"/>	<input checked="" type="checkbox"/>	<input checked="" type="checkbox"/>		
---------------------------	-------------------------------------	-------------------------------------	-------------------------------------	-------------------------------------	-------------------------------------	-------------------------------------	-------------------------------------	-------------------------------------	-------------------------------------	-------------------------------------	-------------------------------------	-------------------------------------	-------------------------------------	--	--

<b>air/water mono-split</b>	domestic hot water	<input checked="" type="checkbox"/>	<input checked="" type="checkbox"/>	<input checked="" type="checkbox"/>	<input checked="" type="checkbox"/>	<input checked="" type="checkbox"/>									<input checked="" type="checkbox"/>
	one zone underfloor			<input checked="" type="checkbox"/>	<input checked="" type="checkbox"/>	<input checked="" type="checkbox"/>								<input checked="" type="checkbox"/>	<input checked="" type="checkbox"/>
	two zones underfloor			<input checked="" type="checkbox"/>	<input checked="" type="checkbox"/>	<input checked="" type="checkbox"/>								<input checked="" type="checkbox"/>	<input checked="" type="checkbox"/>
	one zone fan coil			<input checked="" type="checkbox"/>	<input checked="" type="checkbox"/>	<input checked="" type="checkbox"/>								<input checked="" type="checkbox"/>	<input checked="" type="checkbox"/>
	one zone underfloor and one zone fan coil			<input checked="" type="checkbox"/>	<input checked="" type="checkbox"/>	<input checked="" type="checkbox"/>								<input checked="" type="checkbox"/>	<input checked="" type="checkbox"/>
	one zone underfloor and one zone radiators			<input checked="" type="checkbox"/>	<input checked="" type="checkbox"/>	<input checked="" type="checkbox"/>								<input checked="" type="checkbox"/>	<input checked="" type="checkbox"/>
	one zone radiators			<input checked="" type="checkbox"/>	<input checked="" type="checkbox"/>	<input checked="" type="checkbox"/>								<input checked="" type="checkbox"/>	<input checked="" type="checkbox"/>

<b>air/air multi-split</b>	<input checked="" type="checkbox"/>	<input checked="" type="checkbox"/>	<input checked="" type="checkbox"/>	<input checked="" type="checkbox"/>	<input checked="" type="checkbox"/>	<input checked="" type="checkbox"/>	<input checked="" type="checkbox"/>	<input checked="" type="checkbox"/>	<input checked="" type="checkbox"/>	<input checked="" type="checkbox"/>	<input checked="" type="checkbox"/>	<input checked="" type="checkbox"/>	<input checked="" type="checkbox"/>		
----------------------------	-------------------------------------	-------------------------------------	-------------------------------------	-------------------------------------	-------------------------------------	-------------------------------------	-------------------------------------	-------------------------------------	-------------------------------------	-------------------------------------	-------------------------------------	-------------------------------------	-------------------------------------	--	--

<b>mixed multi-split</b>	air to air and domestic hot water			<input checked="" type="checkbox"/>	<input checked="" type="checkbox"/>	<input checked="" type="checkbox"/>	<input checked="" type="checkbox"/>	<input checked="" type="checkbox"/>	<input checked="" type="checkbox"/>	<input checked="" type="checkbox"/>	<input checked="" type="checkbox"/>	<input checked="" type="checkbox"/>	<input checked="" type="checkbox"/>		<input checked="" type="checkbox"/>
	air to air and air to water			<input checked="" type="checkbox"/>	<input checked="" type="checkbox"/>	<input checked="" type="checkbox"/>	<input checked="" type="checkbox"/>	<input checked="" type="checkbox"/>	<input checked="" type="checkbox"/>	<input checked="" type="checkbox"/>	<input checked="" type="checkbox"/>	<input checked="" type="checkbox"/>	<input checked="" type="checkbox"/>	<input checked="" type="checkbox"/>	
	air to air, air to water and domestic hot water			<input checked="" type="checkbox"/>	<input checked="" type="checkbox"/>	<input checked="" type="checkbox"/>	<input checked="" type="checkbox"/>	<input checked="" type="checkbox"/>	<input checked="" type="checkbox"/>	<input checked="" type="checkbox"/>	<input checked="" type="checkbox"/>	<input checked="" type="checkbox"/>	<input checked="" type="checkbox"/>	<input checked="" type="checkbox"/>	<input checked="" type="checkbox"/>

## iSERIES™ *OUTDOOR UNITS*



### Technical specifications for outdoor units

**Refrigerant flow/volume regulation** via centralised PID control system acting on a vectorial inverter and electronic expansion valves.

**SVPWM180°, vectorial inverter with sensor less 180° PWM**; this is a purely sinusoidal inverter with extremely low electromagnetic noise emissions. It provides constant control of the permanent magnet synchronous motors throughout their 360° revolution (180°+180°). This optimises torque, a key factor in motor control for compressors in particular, thus providing excellent performance in terms of output, efficiency and quietness, especially at low rotational speeds.

**Multi-processor platform** based on the client/server model, with an operating system controlling the motors and microprocessors dedicated to application management fitted in the outdoor and indoor units.

**Standard RS485 bus communication** via shielded bi-polar cable: the highest level of communication security is ensured thanks to a balanced interface normally used for industrial applications. The bus provides an address for each unit and can be wired either as a bus or in a star configuration starting from the outdoor unit. This allows the system to be expanded and developed whilst still ensuring compatibility between units. One advantage of the RS485 bus is the possibility of supplying the units in the system with power either in a centralised manner or each to unit independently.

**Compact and sophisticated electronics**, built using SMD technology, resin coated for protection from atmospheric agents and equipped with certified hardware protection circuits.

**Diagnostic system** for the easy identification of any technical faults, with data logging for technicians accessed directly from bus RS485.

**BootLoader** for software updates for outdoor and indoor units, with no risk of losing flash eprom data.

**Automatic restart** following power black outs, with the same operating parameters as before and restart protected against over pressures.

**Heat exchangers in high quality copper/aluminium with inorganic hydrophilic aluminium**, which does not emit odours and provides top performance in heat exchange output and efficiency.

**Maximum installation flexibility**, thanks to the specifications governing pipe length and height difference between units.

**Rust-proof treatment**, providing the best protection against corrosion and rust formation even under extreme conditions such as in saline mist.

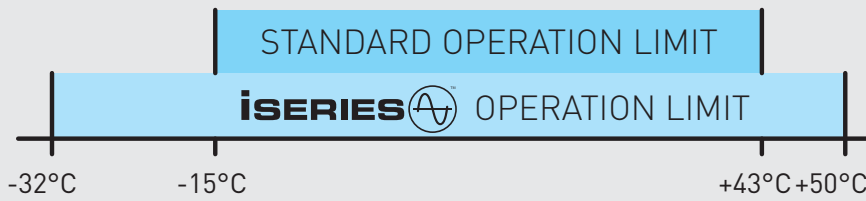

By using state-of-the-art DC Inverter technology, iSeries modulates the power of each outdoor unit from 10% to 130% of the nominal value (the compressor decreases or increases the rotational speeds based on the approximate 100% value).

In this way the compressor continues to operate in modulation, also with heat loads as low as 600 W (GR9FI110), thus avoiding the on/off cycles of other models featuring less sophisticated electronics.

On the other hand, the unit can automatically supply in excess of the nominal power, unlike most traditional multi-split systems, which need the manual activation of the turbo function.

The advantages include:

**increased efficiency** thanks to lower energy consumption (no on/off cycles)

**greater speed and precision** to reach and maintain the required temperature.

The borderline values for the operation of the outdoor units range from -50°C to +50°C, within which the self-protection mechanisms are activated. Many installations exist in Scandinavian countries, which operate with temperatures around -30°C, and others in desert areas with outside temperatures of around 50°C. Obviously, at these temperatures the performance is much lower than the nominal values but operation is guaranteed in any case. The wide operating external temperature range should be underlined to describe the iSeries' high construction quality compared to products of a lower standard. Perfectly operating installations exist at both -32°C and +50°C.

All outdoor units are fitted with two heating elements as standard: one in the unit base to prevent the formation of ice in heating mode (70 W) and one in the compressor casing to prevent the lubricating oil from freezing when the unit is in stand-by (30 W). Both elements are regulated and managed by the system electronics to be activated only when strictly necessary.

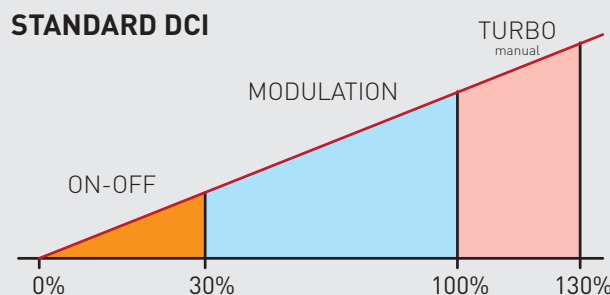
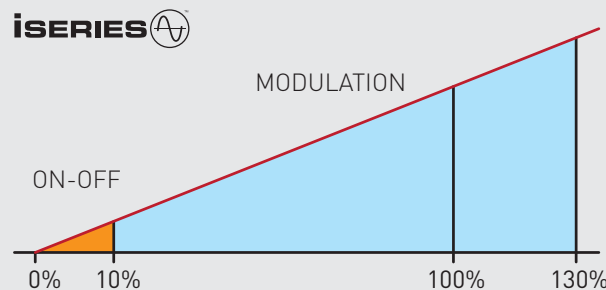



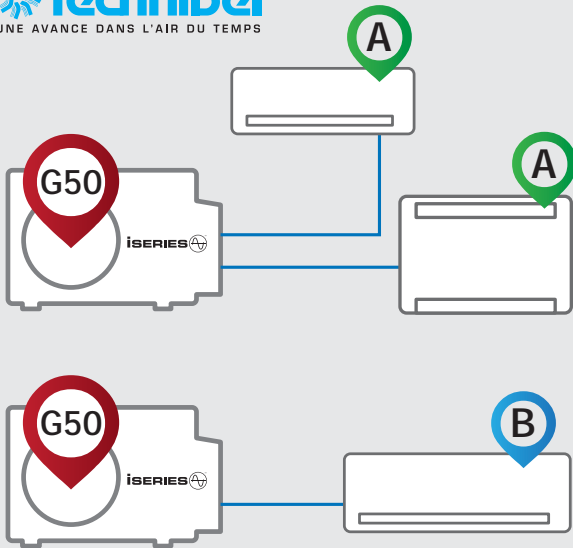

The same indoor units can be used for residential and commercial (package) applications. Different product lines no longer exist. A solution never seen before.

All the outdoor units of the iSeries range may be used in both mono-split (one indoor unit connected with an outdoor unit according to the selection tables) and multi-split configuration (several indoor units connected to an outdoor unit according to the selection tables) without any modification and/or without any special setting required.

Simply, the system adapts to the configuration automatically. This characteristic makes the iSeries unique in the market. As a matter of fact, all brands of air-conditioning systems propose the same indoor units for both mono-split and multi-split configurations (a feature which our units also have).

The process of ice prevention and elimination on the battery of the outdoor unit (needed for any air/air heat pump) in heating mode is managed by an **Intelligent Defrost** and **Non Stop Operation** function.

In most traditional products this process takes place by inverting the cycle (from heating to cooling mode) so that the battery of the outdoor unit is sent to the hot gas flowing out of the compressor, allowing the defrosting of the heat exchanger. This leads to a sudden decrease in the temperature of the batteries of the indoor units. The unit fans are stopped to prevent the infiltration of cold air into the room.

iSeries manages this procedure differently. If the control system does not detect any special temperature or humidity conditions in the outdoor air, the unit does not invert the cycle but rather adopts the gas by-pass technique. Basically, part of the gas leaving the compressor is sent to the battery of the outdoor unit so that it is possible to eliminate the accumulated ice. A quantity of hot gas continues to be sent to the indoor unit (the operation mode is

always on heating). By doing so, the batteries of the indoor units remain at a temperature apt to heat the environment.

In addition to this function, iSeries dynamically understands whether it is possible to keep the fans of the indoor units active to continue to provide heat to the environment.

Example: if an environment is 15° C and the system is on Intelligent Defrost, the function called **Dynamic Cold Draft** recognises that it is still possible to heat the environments (thanks to the fact of having the batteries of the units at a much higher temperature than the same environment) and will therefore keep the fans at the maximum speed possible based on the temperature difference between the battery and environment. Vice versa, if the environment is at a temperature that is very close to the one of the batteries, the system will avoid sending cold air and causing discomfort to the users by stopping the ventilation.

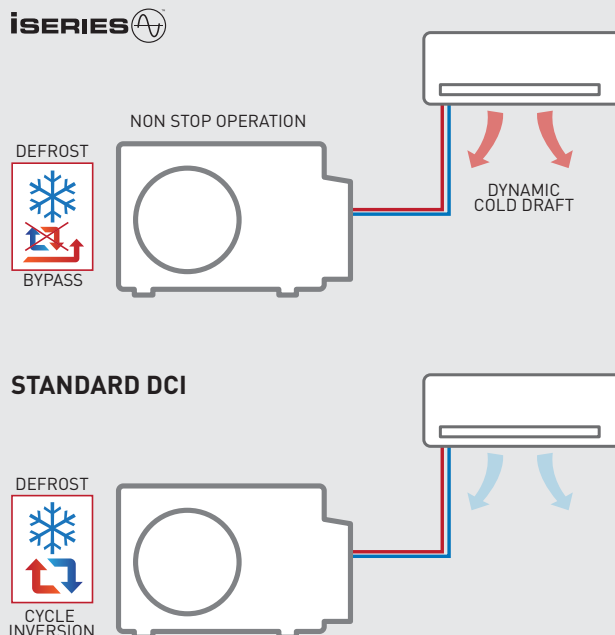



# GR9FI 30 EMX

The smallest mono-split outdoor unit of the iSeries range, usable with any size A air/air indoor unit, is the most compact class A++ outdoor unit complying with the new ERP/Ecodesign regulations. GR9FI30emx may also be connected to an eMix or eMix tank to create a split inverter system suitable for the sole production of domestic hot water from a thermo-dynamic source\*.

## DIMENSIONS (mm)

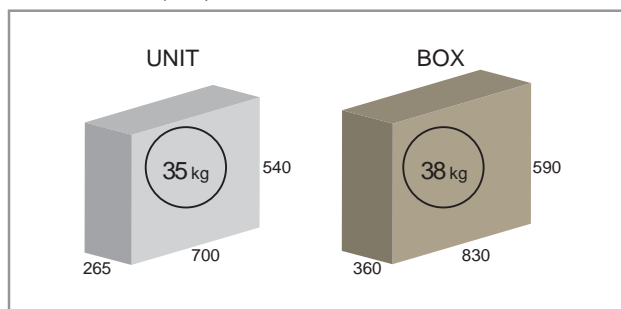

## MINIMUM OPERATION AREA (mm)

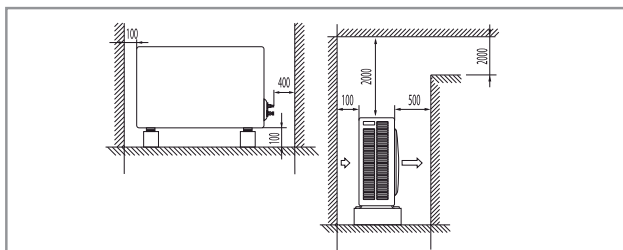

## GAS CONNECTIONS

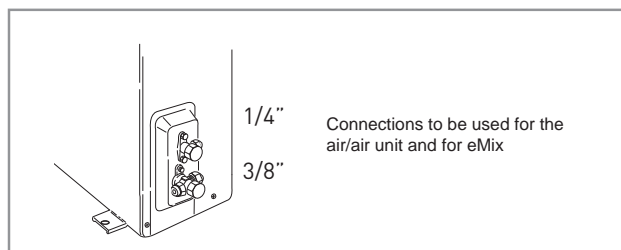

\* Up to a maximum of 80°C and 60°C at 100% from a thermo-dynamic source  
\*\*the GR9FI30 version without eMix port is also available

# GR9FI 30

## AIR AIR

<b>COOLING</b> +35°C	Pdesignc	W	3550	<b>A++</b>
	SEER		6.23	
<b>HEATING</b> Average -10°C	Pdesignh	W	3240	<b>A+</b>
	SCOP		4.39	

ERP Ecodesign - EN14825

### COOLING

+35°C OU / 27/19°C IU	Minimum	W	1370
	Maximum	W	3600

### HEATING

+7/6°C OU / +20°C IU	Minimum	W	930
	Maximum	W	3320
-7/-8°C OU / +20°C IU	Maximum	W	2840
-10/-11°C OU / +20°C IU	Maximum	W	2660
-22/-23°C OU / +20°C IU	Maximum	W	2170

EN14511

## iSERIES INDOOR MATCHING

**A**  
**eMix**

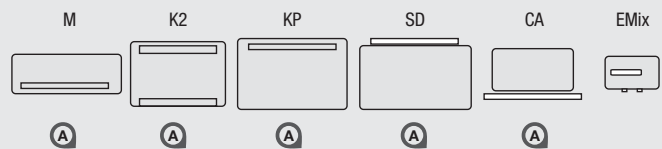

Power supply	V/Ph/Hz	230/1/50
Power Input (max.)	W/A	1550/ 6,90
R410A standard refrigerant charge	kg	0.81
Compressor Type		Single Rotary
Fan speed		Auto
Sound pressure (max.)	dB(A)	40

Liquid Pipe	mm (inch)	6,35 (1/4")
Gas Pipe	mm (inch)	9,52 (3/8")
Total length of pipes (standard load)	m	7,5
Total length of pipes (additional load)	m	15
Maximum height difference (total)	m	10



# GR9FI 42 EMX

Outdoor unit that can be connected to any size A air/air indoor unit both in mono and dual configuration, or to just one size B air/air indoor unit.

It is also possible to connect an eMix or eMix tank (through the dedicated eMix port) to a size A or B indoor unit at the same time, for the production of hot water for domestic use. This means that with GR9FI42emx mono configurations with size A or B, dual with size A, mono size A or B plus eMix and dual with size A plus eMix are possible for air-conditioning and the simultaneous production of hot domestic water in both cooling and heating mode up to thermo-dynamic 80°C.

## DIMENSIONS (mm)

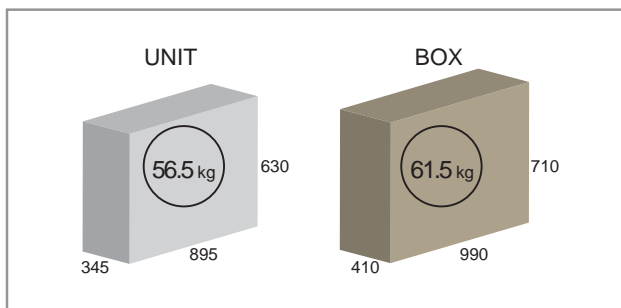

## MINIMUM OPERATION AREA (mm)

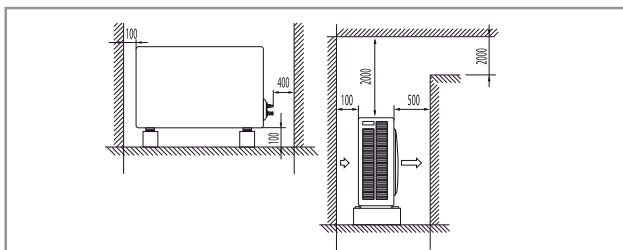

## GAS CONNECTIONS

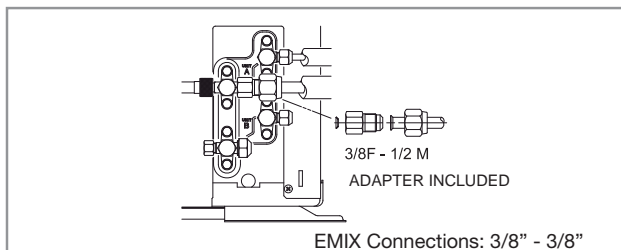

\*the GR9FI42 version without eMix port is also available

# GR9FI 42

## AIR AIR

COOLING +35°C	Pdesignc	W	4300	<b>A++</b>
	SEER		6.52	
HEATING Average -10°C	Pdesignh	W	3420	<b>A+</b>
	SCOP		4.09	

ERP Ecodesign - EN14825

### COOLING

+35°C OU / 27/19°C IU	Minimum	W	1020
	Maximum	W	4310

### HEATING

+7/6°C OU / +20°C IU	Minimum	W	940
	Maximum	W	5150
-7/-8°C OU / +20°C IU	Maximum	W	3030
-10/-11°C OU / +20°C IU	Maximum	W	2900
-22/-23°C OU / +20°C IU	Maximum	W	2400

EN14511

## iSERIES INDOOR MATCHING

**A + A**  
**A + A + eMix**  
**A**  
**A + eMix**  
**B**  
**B + eMix**

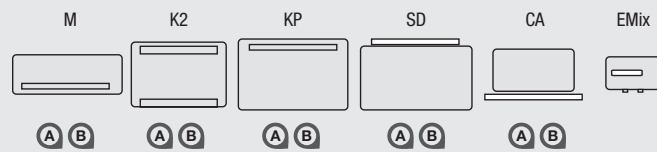

Power supply	V/Ph/Hz	230/1/50
Power Input (max.)	W/A	1790 / 7,80
R410A standard refrigerant charge	kg	1,3
Compressor Type		Twin Rotary
Fan speed		Auto
Sound pressure (max.)	dB(A)	41

Liquid Pipe	mm (inch)	6,35 (1/4")
Gas Pipe	mm (inch)	9,52 (3/8")
Total length of pipes (standard load)	m	Dual 15 / Mono 7.5
Total length of pipes (additional load)	m	Dual 30 / Mono 20
Pipe length per unit (standard load)	m	Dual 12
Pipe length per unit (additional load)	m	Dual 25
Maximum height difference (total)	m	10
Maximum height difference (between indoor units)	m	5



# GR9FI50 EMX

Mono/dual outdoor unit featuring great application flexibility; with GR9FI50emx connections are possible to indoor units of the iSeries range of the air/air type, of the SDHV flexible ductable type, of the Hydrokit type for flooring systems in mono, multi and mixed air/air and air/water configuration. The port dedicated to eMix allows the simultaneous production of domestic hot water up to thermo-dynamic 80°C, with any combination (among those supported) of size A or B indoor units in both cooling and heating mode. With G50emx it is also possible to create a multi application for production of hot domestic water, for example by connecting two eMix Tanks 300 to provide 600 litres of hot water in the battery.

GR9FI50emx offers a range of solutions that go well beyond its mono/dual configuration; just think of a solution with a Hydrokit and an i1218 SDHV unit, two units which can work at the same time or alternatively, for example to heat with the underfloor radiator system and cool and/or de-humidify with the distribution of air through the SDHV unit. Obviously, the eMix or eMix tank module may be added to the two units to produce domestic hot water at the same time during both the heating period and the cooling period.

## DIMENSIONS (mm)

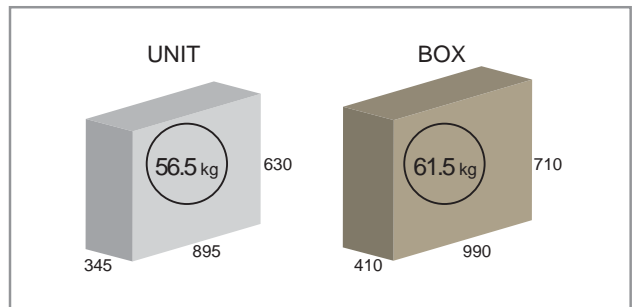

## GAS CONNECTIONS

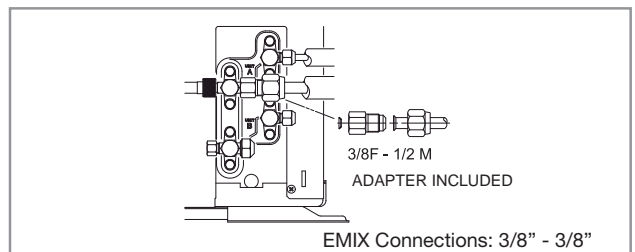

## MINIMUM OPERATION AREA (mm)

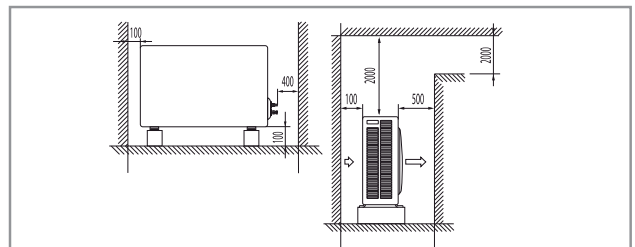

\*the GR9FI50BB version without eMix port is also available

# GR9FI 50

## AIR AIR

COOLING +35°C	Pdesignc	W	5400	A++
	SEER		6.36	
HEATING Average -10°C	Pdesignh	W	4290	A+
	SCOP		4.01	

ERP Ecodesign - EN14825

### COOLING

+35°C OU / 27/19°C IU	Minimum	W	840
	Maximum	W	5900

### HEATING

+7/6°C OU / +20°C IU	Minimum	W	950
	Maximum	W	6000
-7/-8°C OU / +20°C IU	Maximum	W	3930
-10/-11°C OU / +20°C IU	Maximum	W	3730
-22/-23°C OU / +20°C IU	Maximum	W	3270

EN14511

## AIR WATER

GR9FI50EMX+HKBE

EN14511

### COOLING

+35°C

Capacity @ 18/23°C (min/nom/max)	W	840/4500/5730	
EER @ 18/23°C		3,57	
Capacity @ 7/12°C (min/nom/max)	W	-/3150/3470	
EER @ 7/12°C		1,97	

### HEATING

+7°C

-7°C

Capacity @ 30/35°C (min/nom/max)	W	950/5240/5920	-/3800/3950
COP @ 30/35°C		4,22	2,37
Capacity @ 40/45°C (min/nom/max)	W	-/4930/5500	-/3210/3380
COP @ 40/45°C		3,31	1,83
Capacity @ 45/50°C (min/nom/max)	W	-/4780/5270	-/3100/3650
COP @ 45/50°C		2,96	1,92
Capacity @ 20/25°C (min/nom/max)	W	-/6200/7300	-/3160/3720
COP @ 20/25°C		5,36	2,73

## iSERIES INDOOR MATCHING

A + A  
 A + A + eMix  
 A + B  
 A + B + eMix  
 B  
 B + eMix  
 C (only ADICS10)  
 C (only ADICS10) + eMix

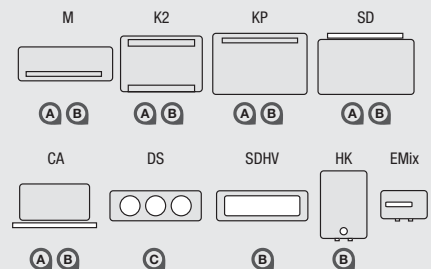

Power supply	V/Ph/Hz	230/1/50
Power Input (max.)	W/A	1790 / 7,80
R410A standard refrigerant charge	kg	1,3
Compressor Type		Twin Rotary
Fan speed		Auto
Sound pressure (max.)	dB(A)	41

Liquid Pipe	mm (inch*)	6,35 (1/4")
Gas Pipe	mm (inch*)	9,52 (3/8")
Total length of pipes (standard load)	m	Dual 15 / Mono 7.5
Total length of pipes (additional load)	m	Dual 30 / Mono 20
Pipe length per unit (standard load)	m	Dual 12
Pipe length per unit (additional load)	m	Dual 25
Maximum height difference (indoor/outdoor units)	m	10
Maximum height difference (indoor/indoor units)	m	5



# GR9FI 65 EMX

GR9FI65emx, with its power, mono/dual/trial connections, compact size and the possibility of connecting an eMix or eMix tank, is suitable to create a wide range of summer and winter air-conditioning solutions, with or without domestic hot water production, in small family homes, residential flats or offices as well as in restaurants, stores and in general commercial premises of a size suitable to the maximum thermal power provided by the unit.

All the types of indoor units of the iSeries range are recognised and may work in single, multiple and mixed mode.

GR9FI65emx is very flexible in the mixed air/air configurations with air/water, allowing the installation of underfloor radiator systems or low temperature radiators, at the same time as any type of direct expansion indoor units (wall mounted, floor/ceiling mounted, consoles, cassettes, ductable) and obviously the SDHV units with sound-proofed flexible ducting to reach every corner of the building, bathrooms and kitchen included. Worth remembering is the possibility of mono/multi configuration with eMix and eMix tank units for the creation of batteries suitable for the production of domestic hot water only.

## MINIMUM OPERATION AREA (mm)

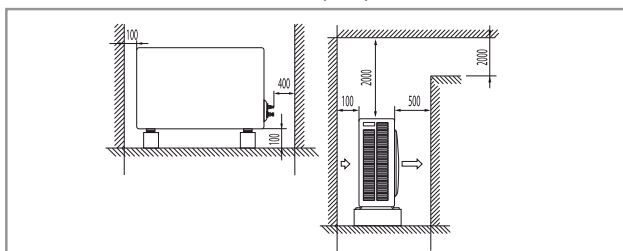

## DIMENSIONS (mm)

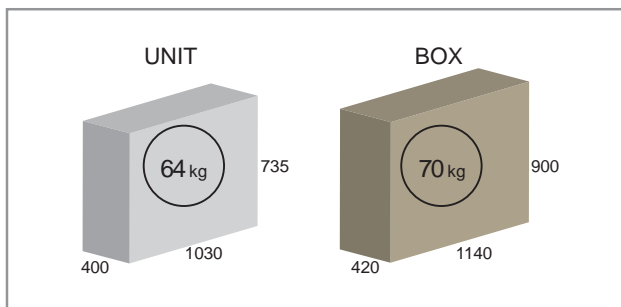

## GAS CONNECTIONS

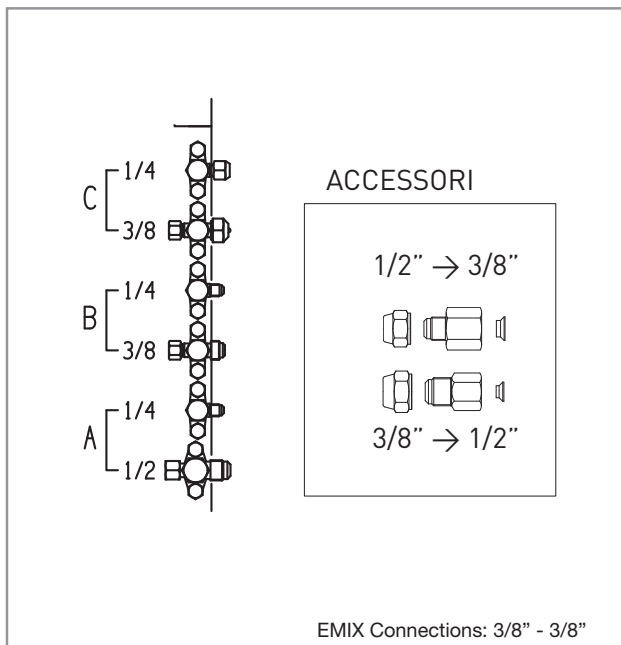

\*the GR9FI65 version without eMix port is also available



# GR9FI 65

## AIR AIR

COOLING +35°C	Pdesignc	W	6500	A++
	SEER		6.49	
HEATING Average -10°C	Pdesignh	W	6400	A+
	SCOP		4.01	

ERP Ecodesign - EN14825

### COOLING

+35°C OU / 27/19°C IU	Minimum	W	1570
	Maximum	W	7650

### HEATING

+7/6°C OU / +20°C IU	Minimum	W	1820
	Maximum	W	8670
-7/-8°C OU / +20°C IU	Maximum	W	5920
-10/-11°C OU / +20°C IU	Maximum	W	5340
-22/-23°C OU / +20°C IU	Maximum	W	4260

EN14511

## AIR WATER

GR9FI65EMX+HKBE

EN14511

### COOLING

+35°C

Capacity @ 18/23°C (min/nom/max)	W	1570/6000/7000
EER @ 18/23°C		3,60
Capacity @ 7/12°C (min/nom/max)	W	-/5200/5640
EER @ 7/12°C		2,58

### HEATING

+7°C

-7°C

Capacity @ 30/35°C (min/nom/max)	W	1820/8220/9330	-/5210/5410
COP @ 30/35°C		4,14	2,80
Capacity @ 40/45°C (min/nom/max)	W	-/7290/7600	-/4720/4950
COP @ 40/45°C		3,25	2,20
Capacity @ 50/55°C (min/nom/max)	W	-/5650/6500	-/3500/3890
COP @ 50/55°C		2,63	1,58
Capacity @ 20/25°C (min/nom/max)	W	-/8700/9450	-/4500/5260
COP @ 20/25°C		5,48	2,70

## iSERIES INDOOR MATCHING

A + A + A  
A + A + A + eMix  
A + A + B  
A + A + B + eMix  
B + B  
B + B + eMix  
A + B  
A + B + eMix  
A + A  
A + A + eMix  
B  
B + eMix  
C  
C + eMix

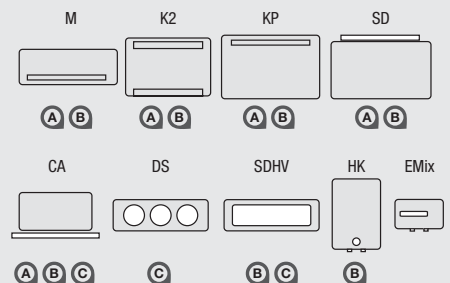

Power supply	V/Ph/Hz	230/1/50
Power Input (max.)	W/A	2600 / 12
R410A standard refrigerant charge	kg	2.7
Compressor Type		Twin Rotary
Fan speed		Auto
Sound pressure (max.)	dB(A)	41

Liquid Pipe	mm (inch)	6,35 (1/4")
Gas Pipe	mm (inch)	9,52 (3/8") / 12,77 (1/2")
Total length of pipes (standard load)	m	Multi 30 / Mono 20
Total length of pipes (additional load)	m	Multi 45 / Mono 35
Pipe length per unit (standard load)	m	Dual 25 / Trial 20
Pipe length per unit (additional load)	m	Dual 30 / Trial 25
Maximum height difference (indoor/outdoor units)	m	10
Maximum height difference (indoor/indoor units)	m	5



# GR9F 80 EMX

GR9F180emx is an outdoor unit for border applications between residential and small service sector complexes. With its thermal power, the compact size of a mono fan structure, the possibility of creating mono, dual, tri and quadri split systems and the simultaneous production of domestic hot water, GR9F180emx is the perfect solution to use as a primary heating system, able to offer an air-conditioning service all year long, with an air and/or water unit, underfloor panel heaters or low temperature radiators, flexible ducting and hot water heated with the renewable energy of the GR9F180emx heat pump.

No less important is the possibility of installing up to four eMix units, dedicating GR9F180emx just to producing large quantities of domestic hot water for hotels, schools, factories, the availability of the version for three-phase power supply (during 2013) and the multiple opportunities offered for applications in the service sector with cassettes, ductable units, slim ducted for hotel, SDHV flexible ductable units.

## MINIMUM OPERATION AREA (mm)

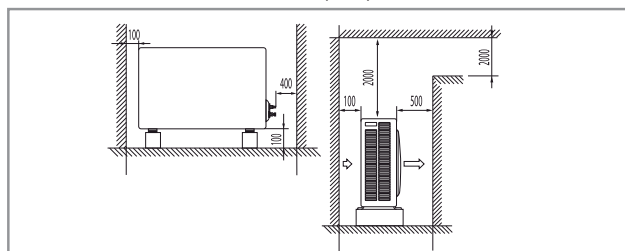

## DIMENSIONS (mm)

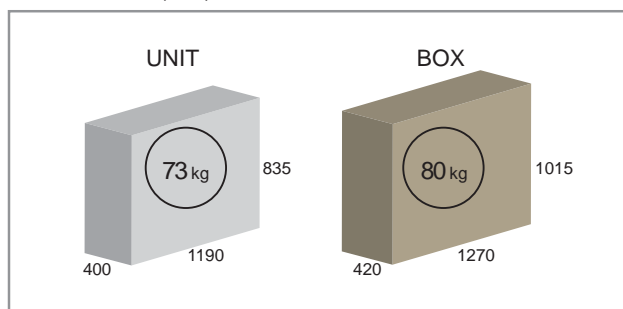

## GAS CONNECTIONS

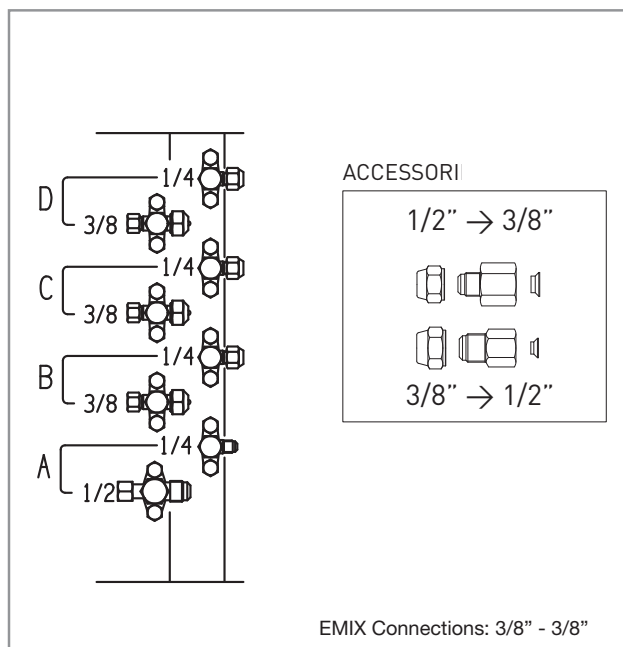

EMIX Connections: 3/8" - 3/8"

\*the GR9F180 version without eMix port is also available

# GR9FI 80

## AIR AIR

COOLING +35°C	Pdesignc	W	8970	A++
	SEER		6.74	
HEATING Average -10°C	Pdesignh	W	7660	A+
	SCOP		4.07	

ERP Ecodesign - EN14825

### COOLING

+35°C OU / 27/19°C IU	Minimum	W	1600
	Maximum	W	9620

### HEATING

+7/6°C OU / +20°C IU	Minimum	W	1700
	Maximum	W	11200
-7/-8°C OU / +20°C IU	Maximum	W	6780
-10/-11°C OU / +20°C IU	Maximum	W	6480
-22/-23°C OU / +20°C IU	Maximum	W	4930

EN14511

## AIR WATER

GR9FI80EMX+HKCE

EN14511

### COOLING

+35°C

Capacity @ 18/23°C (min/nom/max)	W	1600/7980/9400
EER @ 18/23°C		4,01
Capacity @ 7/12°C (min/nom/max)	W	-/6870/8100
EER @ 7/12°C		2,84

### HEATING

+7°C

-7°C

Capacity @ 30/35°C (min/nom/max)	W	1700/9700/10800	-/5890/6200
COP @ 30/35°C		4,06	2,59
Capacity @ 40/45°C (min/nom/max)	W	-/8010/9100	-/5700/6100
COP @ 40/45°C		3,36	2,35
Capacity @ 50/55°C (min/nom/max)	W	-/6400/7530	-/3900/4600
COP @ 50/55°C		2,49	1,49
Capacity @ 20/25°C (min/nom/max)	W	-/10240/12050	-/5120/6020
COP @ 20/25°C		5,03	2,56

Power supply	V/Ph/Hz	230/1/50
Power Input (max.)	W/A	3300 / 15
R410A standard refrigerant charge	kg	3.0
Compressor Type		Twin Rotary
Fan speed		Auto
Sound pressure (max.)	dB(A)	47
Liquid Pipe	mm (inch)	6,35 (1/4")
Gas Pipe	mm (inch)	9,52 (3/8") / 12,77 (1/2")
Total length of pipes (standard load)	m	Multi 40 / Mono 30
Total length of pipes (additional load)	m	Multi 65 / Mono 50
Pipe length per unit (standard load)	m	30
Pipe length per unit (additional load)	m	50
Maximum height difference (indoor/outdoor units)	m	10
Maximum height difference (indoor/indoor units)	m	5

## iSERIES INDOOR MATCHING

A + A + A + A  
 A + A + A + A + eMix  
 A + A + A + B  
 A + A + A + B + eMix  
 A + A + A  
 A + A + A + eMix  
 A + A + B  
 A + A + B + eMix  
 A + B + B  
 A + B + B + eMix  
 B + B  
 B + B + eMix  
 A + B  
 A + B + eMix  
 A + A  
 A + A + eMix  
 A + C  
 A + C + eMix  
 B  
 B + eMix  
 C  
 C + eMix

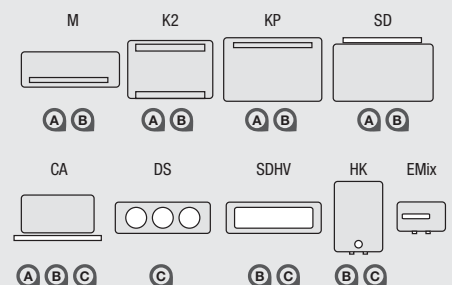



# GR9F 110 EMX

It is the iSeries most powerful outdoor unit currently available; with its thermal 13 kW it perfectly suits the applications for the service sector, where the wide range of indoor units expresses its maximum flexibility. Likewise GR9F110emx is a great primary heating and air-conditioning solution for moderately sized residential buildings, whether these are large flats or family homes. GR9F110emx features a compact structure with a single fan in single-phase and three-phase version (during 2013) and offers four ports per indoor unit as well as the eMix port for the production of domestic hot water at the same time as heating and air-conditioning. Mono, dual, tri and quadri split solutions are thus possible by combining all the types and sizes of iSeries indoor units, standard air/air, SDHV type air/air, air/water (hydrokit for underfloor heating/cooling or low temperature radiators) and obviously eMix and eMix Tank, also in battery for just producing hot water from a renewable source in large quantities (up to 1200 litres per system).

## DIMENSIONS (mm)

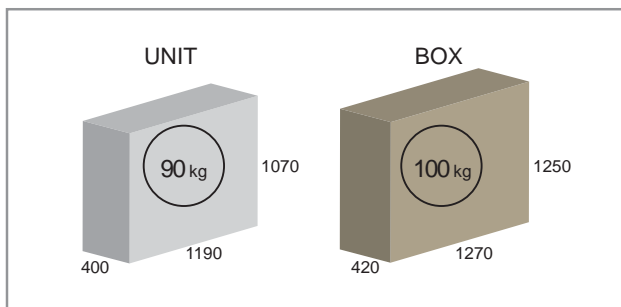

## GAS CONNECTIONS

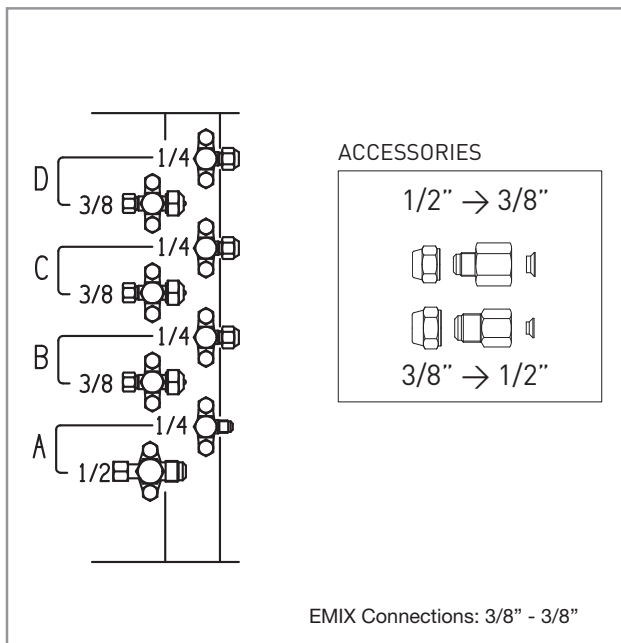

## MINIMUM OPERATION AREA (mm)

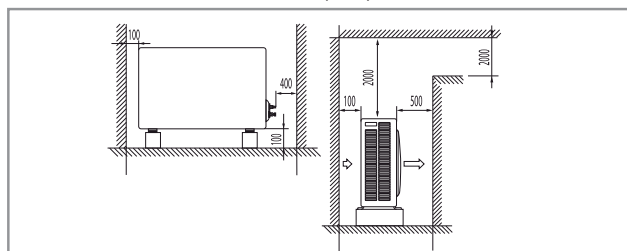

EMIX Connections: 3/8" - 3/8"

# GR9FI 110

## AIR AIR

COOLING +35°C	Pdesignc	W	10640	A++
	SEER		6.60	
HEATING Average -10°C	Pdesignh	W	9400	A+
	SCOP		4.12	

ERP Ecodesign - EN14825

## COOLING

+35°C OU / 27/19°C IU	Minimum	W	1800
	Maximum	W	11500

## HEATING

+7/6°C OU / +20°C IU	Minimum	W	1900
	Maximum	W	13500
-7/-8°C OU / +20°C IU	Maximum	W	8300
-10/-11°C OU / +20°C IU	Maximum	W	7530
-22/-23°C OU / +20°C IU	Maximum	W	6010

EN14511

## AIR WATER

GR9FI110EMX+HKDE

EN14511

### COOLING

+35°C

Capacity @ 18/23°C (min/nom/max)	W	1800/10320/12280
EER @ 18/23°C		-
Capacity @ 7/12°C (min/nom/max)	W	-/8940/10640
EER @ 7/12°C		-

### HEATING

+7°C

-7°C

Capacity @ 30/35°C (min/nom/max)	W	1900/11770/13220	-/7060/7430
COP @ 30/35°C		-	-
Capacity @ 40/45°C (min/nom/max)	W	-/9500/10820	-/6760/7260
COP @ 40/45°C		-	-
Capacity @ 50/55°C (min/nom/max)	W	-/7640/9095	-/4580/5450
COP @ 50/55°C		-	-
Capacity @ 20/25°C (min/nom/max)	W	-/12440/14800	-/6220/7320
COP @ 20/25°C		-	-

the data reported in the table is to be considered as preliminary

Power supply	V/Ph/Hz	230/1/50
Power Input (max.)	W/A	3300 / 15
R410A standard refrigerant charge	kg	3.0
Compressor Type		Twin Rotary
Fan speed		Auto
Sound pressure (max.)	dB(A)	47
Liquid Pipe	mm (inch)	6,35 (1/4")
Gas Pipe	mm (inch)	9,52 (3/8") / 12,77 (1/2")
Total length of pipes (standard load)	m	Multi 40 / Mono 30
Total length of pipes (additional load)	m	Multi 65 / Mono 50
Pipe length per unit (standard load)	m	30
Pipe length per unit (additional load)	m	50
Maximum height difference (indoor/outdoor units)	m	10
Maximum height difference (indoor/indoor units)	m	5

## iSERIES INDOOR MATCHING

A + A + A + A  
 A + A + A + A + eMix  
 A + A + A + B  
 A + A + A + B + eMix  
 A + A + B + B  
 A + A + B + B + eMix  
 A + B + B + B  
 A + B + B + B + eMix  
 A + A + A  
 A + A + A + eMix  
 A + A + B  
 A + A + B + eMix  
 A + B + B  
 A + B + B + eMix  
 B + B + B  
 B + B + B + eMix  
 B + B  
 B + B + eMix  
 A + C  
 A + C + eMix  
 A + B  
 A + B + eMix  
 A + A  
 A + A + eMix  
 B + C  
 B + C + eMix  
 B  
 B + eMix  
 C  
 C + eMix  
 D  
 D + eMix

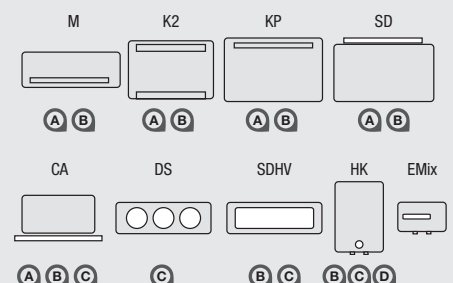

**iSERIES™ SYSTEMS**

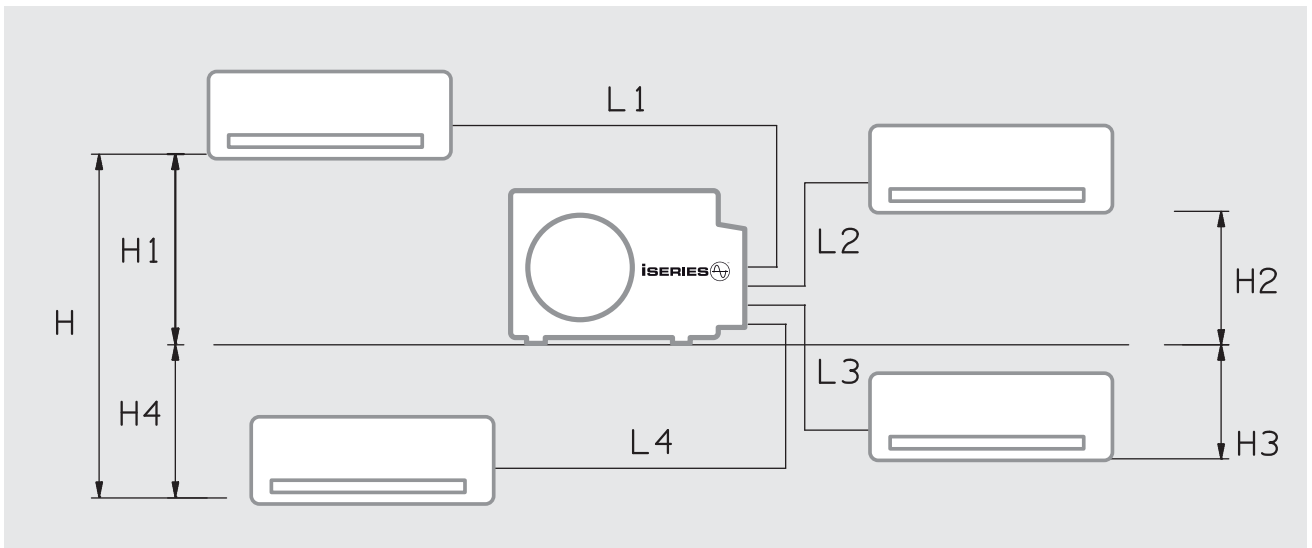

		STANDARD LOAD		ADDITIONAL LOAD	
		L Tot (m)	L n (m)	L Tot (m)	L n (m)
<b>GR9FI30</b>	Mono	7,5	-	15	-
<b>GR9FI42</b>	Mono	7,5	-	20	-
	Dual	15	12	30	25
<b>GR9FI50</b>	Mono	7,5	-	20	-
	Dual	15	12	30	25
<b>GR9FI65</b>	Mono	20	-	35	-
	Dual	30	25	45	30
	Trial	30	20	45	25
<b>GR9FI80</b>	Mono	30	-	50	-
	Dual	40	30	65	30
	Trial	40	30	65	30
	Quadri	40	30	65	30
<b>GR9FI110</b>	Mono	30	-	50	-
	Dual	40	30	65	30
	Trial	40	30	65	30
	Quadri	40	30	65	30

Tot L = Total length of pipes, given by the sum of pipe lengths for each indoor unit (L1+L2+L3...)

L n = Maximum pipe length per single indoor unit (n = 1, 2, 3...)

**QUANTITY OF ADDITIONAL REFRIGERANT**

for pipes 1/4" - 3/8" = 15 g/m  
for pipes 1/4" - 1/2" = 20 g/m

**MAXIMUM HEIGHT DIFFERENCE OUTDOOR UNIT/INDOOR UNIT: 10 m - H1, H2, H3, H4**

**MAXIMUM HEIGHT DIFFERENCE BETWEEN INDOOR UNITS: 5 m - H**

# iSERIES™ INDOOR UNITS

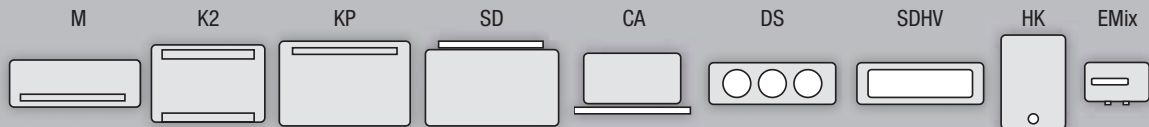

Every indoor unit in the iSERIES™ system has its own specific features but there are also features common to all units in the range, these are listed here below.

**Dynamic Cold Draft**, an active protection system preventing the emission of air that is noticeably colder than ambient temperature during heating operation and particularly during defrost stages.

**Antifreeze**, this protection system prevents the formation of ice on the indoor unit heat exchanger when the system is working in cooling mode and there are particular temperature and humidity conditions.

**Temperature settings from +10°C to +32°C** both in cooling and heating modes; the units can therefore be used for indoor low ambient temperature applications such as in cellars, server rooms and radio stations... They can also be used to maintain a minimum temperature in spaces that are unused during weekends such as offices and shops, or places that are unused during the week such as holiday homes in the mountains or at the seaside...

**iFEEL function**, a comparative function that ensures optimum temperature settings based on the values read at the remote control sensor, the sensor in the indoor unit and the resulting ambient temperature stratification conditions, which are always different from one room to another.

**Wide range IR receiver**, this receives the remote control signal even under difficult conditions. It is equipped with a noise canceller for complete immunity from interference generated by low energy consumption fluorescent bulbs.

**Hardware or software addressing** of units for recognition on communication bus RS485.

**Remote control addressing** for the management of one or more grouped indoor units, up to a maximum of four units. This function is useful where several indoor units are situated in a large space (open space offices, hotel reception rooms, restaurants, etc...), and need to be controlled either by one or several remote controls.

**Five operating modes**: automatic, cool, heat, dehumidify and fan.

**Night Function** for maximum operating economy during the night without compromising comfort.

**High Power Function**, when maximum power is required straight away.

**Active/passive air filters**: all air/air units are equipped with washable mesh filters and can be fitted with an activated charcoal filter; some units are fitted as standard with a titanium dioxide photocatalytic anti-bacterial filter, activated via remote control by invisible dedicated LEDs fitted inside the unit, fully compliant with EU regulations concerning UV emissions.

**Intelligent air flap control** based on operating mode, which when combined with the iFEEL function offers the maximum in comfort to counter air temperature stratification effects.

**Automatic fan** (or manual fan) to provide maximum heat (when required) and the right amount of cool, without creating annoying cold air draughts or excessive amounts of hot air.

**Timer** for programming the operating times of each individual indoor unit, with weekend\* and holiday\* controls.

**Wireless and wired universal remote control** for all iSERIES™ indoor units, with multi-function keypad, LCD graphic display, wall mount and wired connection. Elegant ergonomic interface with **discreet micro LEDs that can be deactivated** via remote control, particularly useful for those that prefer complete darkness at night.

**Protective grilles**, which offer the maximum in safety in compliance with standard EN60335. This allows for installation even at low heights where children could otherwise potentially touch moving parts such as fans and motors.

**Heat exchangers in high quality copper/aluminium with inorganic hydrophilic aluminium**, which does not emit odours and provides top performance in heat exchange output and efficiency.

**Plastic materials** with high quality looks and functional properties (improved thermal stability). As green as possible thanks to the use of noble acrylics such as PMMA, pure ABS for the parts on view and recycled PS for the internal structures.

**Hydrokit with heat exchanger with plates** made from AISI316L stainless steel for heat exchange between the refrigerant and water, built-in module for additional electrical heating, automatically controlled by software in three steps, controlled by thermal-magnetic switches that can be deactivated manually, safety thermostats, pressure switch, high performance water pump and water flow rate control device.

**Controller for hydrokit**, with climatic curve control and control of the various applications of the hydronic circuit (floor, fan coils, radiators, mixed...), with the possibility of separation into areas with different settings.

Wide range of hydronic accessories to suit various different system configurations.

Generation of **domestic hot water using the eMix™** module, the internal unit for the iSERIES™ system, which is able to provide hot water from a thermodynamic source all year round. eMix™ will be available during 2013 and it will have a specific document illustrating the functions dedicated to it and the operating mode in connection to the iSERIES™ system.



# MF

**Model:**

MFIA (unit)  
 P1 |  
 P2 (front panel) |  
 P3 |

MF, a unique wall-mounted indoor unit: another step towards the integration with furnishing accessories. Consisting of a unit body completely made of precious paintable ABS and three types of panel, which may be chosen to match the characteristics of the environment of installation.

A12 White



A12 Oak



A12 Wengè

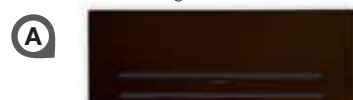



# MFIA

## MFIA

Air flow rate I.U. (el.-l.-m.-h.)	m³/h	250-410-480-600
Dehumidification	l/h	1,5
Fan speed	N°	Auto + 3 remote control settings
Sound pressure I.U. (el.-l.-m.-h.)	dB(A)	21-29-36-39
Electrical power supply	V/Ph/Hz	230/1/50
Power input	kW	0,031
Current input	A	0,13
Liquid pipe diameter	mm (")	6,35(1/4")
Gas pipe diameter	mm (")	9,52(3/8")
Net weight I.U.	kg	10,5
Net dimensions I.U. (H./W./D.D of recess-fitted I.U.)	mm	305x895x195/110

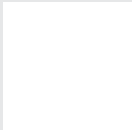

WHITE



OAK

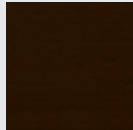

WENGÉ

The two Oak and Wenge panels are made of oil-phenolic plywood, while the white panel is made of water repellent wood fiber to be totally immune to deformation and formation of condensation.

## DC MOTOR

A tangential fan powered by a DC brushless motor and a brand new control circuit, which consumes just 75mW in standby, ensure very high levels of comfort in almost complete silence.

## LOCK + MAGNET



MF is also fitted with a panel with the Lock & Magnet quick coupling system which carries out all the maintenance and filter cleaning operations of the panel, in the simplest and safest manner possible. Just secure the panel to the upper bushes and the magnets will make the panel more solid.

MF is designed to provide high energy efficiency and has one very important feature: it can be built-in using the dedicated wall mounting kit.

MF is also easy to install, thanks to the possibility of connecting the refrigerant pipes either to horizontal compartment or to the right side; the bilateral condensation discharge pipe and the possibility of fitting the unit at below two metres in height (thanks to the protection grille), complete the flexibility of this high quality unit.

84 mm

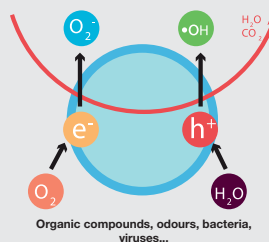

MF is equipped with an active photocatalytic filter that is able to significantly reduce the bacterial load in the environment thanks to the titanium dioxide oxidation process activated by completely concealed special UV LEDs that are fully compliant with EU standards. This filter uses the oxidising power of Titanium Dioxide (TiO<sub>2</sub>) to destroy bacteria and inhibit viruses. It also effectively reduces dust and dirt particles and helps to prevent unpleasant odours.



# MT

**Model:**

MTAFIA0R5  
MTAFBIA0R5

A8, a wall-mounted indoor unit with a distinctive design, ideal for modern spaces and also compatible with more conventional styles. Combines easily with many different styles and colours found in the office and at home.

MTAFBIA0R5



MTAFIA0R5



Dimensions: HxLxD 305x895x195/110 mm  
Weight: 10.5 kg



Air flow rate I.U. (el.-l.-m.-h.)	m <sup>3</sup> /h	250-410-480-600
Dehumidification	l/h	1,5
Fan speed	N°	Auto + 3 remote control settings
Sound pressure I.U. (el.-l.-m.-h.)	dB(A)	21-29-36-39
Electrical power supply	V/Ph/Hz	230/1/50
Power input	kW	0,031
Current input	A	0,13
Liquid pipe diameter	mm (")	6,35(1/4")
Gas pipe diameter	mm (")	9,52(3/8")
Net weight I.U.	kg	10,5
Net dimensions I.U. (H.xWxD/D built-in)	mm	305x895x195/110



**MT** has a front panel made of PMMA, a prized acrylic material, is dual coated on the back and available in satin white or carbon fibre black; the transparent border along the panel perimeter creates a bright frame that responds to colour changes in the environment. The horizontal central strip in silver conceals the noiseless remote control signal receiver and the extremely elegant blue and white micro LEDs. These are very discreet and can also be deactivated using a function developed specifically for those that prefer complete darkness at night.

**MT** is designed to provide high energy efficiency and has one very important feature: it can be built-in using the dedicated wall mounting kit.

**MT** is also easy to install, thanks to the possibility of connecting the refrigerant pipes either to the horizontal compartment or to the right side; the bilateral condensation discharge pipe and the possibility of fitting the unit at below two metres in height (thanks to the protection grille), complete the flexibility of this high quality unit.

84 mm

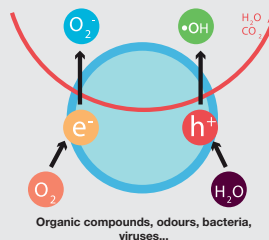

**MT** is equipped with an active photocatalytic filter, which is able to significantly reduce the bacterial load in the environment thanks to the titanium dioxide oxidation process activated by completely concealed special UV LEDs that are fully compliant with EU standards. This filter uses the oxidising power of Titanium Dioxide (TiO<sub>2</sub>) to destroy bacteria and inhibit viruses. It also effectively reduces dust and dirt particles and helps to prevent unpleasant odours.



# MP

**Model:**

MPAFIA  
MPA9FIB

Elegant and discreet, available in sizes A (A7) and B (A9), an indoor unit to suit all tastes, suitable for all settings both in terms of design and heat output.

MPA9FIB

**B**



Dimensions: HxLxD 285x995x240 mm  
Weight: 12 kg

MPAFIA

**A**



Dimensions: HxLxD 270x805x215 mm  
Weight: 8 kg



# MP

		MPA FIA	MPA9 FIB
Air flow rate I.U. (el.-l.-m.-h.)	m³/h	390-430-450-470	410-580-710-880
Dehumidification	l/h	1,5	2,0
Fan speed	N°	Auto + 3 remote control settings	Auto + 3 remote control settings
Sound pressure I.U. (el.-l.-m.-h.)	dB(A)	23-29-36-39	29-35-43-47
Electrical power supply	V/Ph/Hz	230/1/50	230/1/50
Power input	KW	0,031	0,086
Current input	A	0,13	0,40
Liquid pipe diameter	mm (")	6,35(1/4")	6,35(1/4")
Gas pipe diameter	mm (")	9,52(3/8")	12,7(1/2")
Net weight I.U.	kg	8	12
Net dimensions I.U. (H./W./D.)	mm	270x805x215	285x995x240



The casing for model **MP** is treated using a photo engraving technique to obtain a satin effect on the plastic, this is done during the injection stage and no further treatments are applied. You can see the quality of the material and manufacturing process used with the naked eye, this sets the **MP** unit apart from other white wall-mounted indoor units.



**MP** allows condensation discharge to the right or left, it has LEDs that can be deactivated and washable filters, it is compact and easy to install.

## Mesh filters with optional odour-capturing activated charcoal filter

The optional activated charcoal filter is comprised of a layer of synthetic material folded to increase the filtering surface area and treated with a professional anti-bacterial solution, combined with an activated charcoal mesh. Activated charcoal is a material mainly made up of carbon in the form of graphite micro crystals treated in such a way as to create a porous structure with a vast internal

surface area. When the forced air flow passes through the filter element, the charge of static energy allows the filter to trap even the smallest particles of pollutants and allergens, down to a size of 0.01 microns. The activated charcoal layer attracts and absorbs the organic molecules responsible for unpleasant odours, eliminating them completely.

very quiet: **only 23 dB(A)**

Heat exchanger in odourless inorganic hydrophilic aluminium



# K2

**Model:**

K2FAFIA

K2FAFIB

A refined console for low wall installation, at just a few centimetres from the floor and with two-way air flow, up and down, for maximum comfort in summer and winter.



Dimensions: HxLxD 600x750x220 mm  
Weight: 18 kg

 **Technibel**  
UNE AVANCE DANS L'AIR DU TEMPS

# K2

		K2FA FIA	K2FA FIB
Air flow rate I.U. (el.-l.-m.-h.)	m³/h	450-500-590-700	615-665-760-830
Dehumidification	l/h	1,3	2,3
Fan speed	N°	Auto + 3 remote control settings	Auto + 3 remote control settings
Sound pressure I.U. (el.-l.-m.-h.)	dB(A)	22/26/30/37	28/30/37/45
Electrical power supply	V/Ph/Hz	230/1/50	230/1/50
Power input	kW	0,017	0,019
Current input	A	0,07	0,08
Liquid pipe diameter	mm (")	6,35(1/4")	6,35(1/4")
Gas pipe diameter	mm (")	9,52(3/8")	12,7(1/2")
Net weight I.U.	kg	18	18
Net dimensions I.U. (H./W./D.)	mm	600x750x220	600x750x220



K2 is equipped with DCM (DC motors). In stand by it consumes just 75 mW (thousandth of a watt) and is fitted with a humidity sensor used to modulate the temperature according to the temperature index perceived or to limit the maximum percentage of relative humidity in the environment. In addition, as shown in the figure, the two fans are activated in a differential mode to provide the best air distribution according to the operating cooling or heating mode.

SUMMER

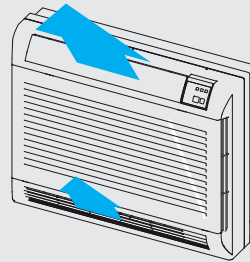

WINTER

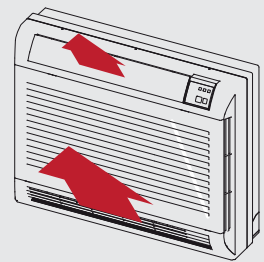

K2 is made of a prized ABS and is well suited for installation under windows or mid-wall, occupying the smallest space possible. K2 is available in sizes A and B, whilst still maintaining the same structure and dimensions. It filters and purifies the air using a washable mesh filter and a titanium dioxide photocatalytic filter that can be activated via remote control. At 22 dB(A), the unit is extremely quiet thanks to its specially-designed structure and two tangential fans managed by inverter-controlled DC motors.

### DC MOTOR

A tangential fan powered by a DC brushless motor and a brand new control circuit, which consumes just 75mW in standby, ensure very high levels of comfort in almost complete silence.



- LED operation can be deactivated by remote control

very quiet: **only 22 dB(A)**



# KP

**Model:**

KPA8FIA

KPA9FIB

# SD

**Model:**

SDIAS8

SDIBS9

KP and SD, two versions of the same unit, reversible for floor or ceiling installation, they can be fitted on view (KP) or concealed in dedicated spaces (SD) created using plasterboard or wood or in false ceilings.

KP **A**  
**B**



Dimensions: HxLxD 680x900x190 mm  
Weight: 23.5 kg

SD **A**  
**B**



Dimensions: HxLxD 585x890x190 mm  
Weight: 25 kg

\* During 2013 also KP size C will be available

*very quiet:*

**only 24 dB(A)**

*Heat exchanger in odourless inorganic hydrophilic aluminium*

 **Technibel**  
UNE AVANCE DANS L'AIR DU TEMPS



# KP SD

		KPA8 FIA	KPA9 FIB	SDIA S8	SDIB S9
Air flow rate I.U. (el.-l.-m.-h.)	m³/h	450-500-590-700	615-665-760-830	300-340-380-470	470-520-600-680
Dehumidification	l/h	1,3	2,3	1,3	3,3
Fan speed	N°	Auto + 3 remote control settings			
Sound pressure I.U. (el.-l.-m.-h.)	dB(A)	24-26-30-37	35-40-46-49	24-26-30-37	35-40-46-49
Electrical power supply	V/Ph/Hz	230/1/50	230/1/50	230/1/50	230/1/50
Power input	kW	0,037	0,075	0,037	0,075
Current input	A	0,17	0,33	0,17	0,33
Liquid pipe diameter	mm (")	6,35(1/4")	6,35(1/4")	6,35(1/4")	6,35(1/4")
Gas pipe diameter	mm (")	9,52(3/8")	12,7(1/2")	9,52(3/8")	12,7(1/2")
Net weight I.U.	kg	23,5	23,5	25	25
Net dimensions I.U. (H./W./D.)	mm	680x900x190	680/900/190	585x890x190	585x890x190



- Easy installation and condensation discharge
- Easy maintenance



- It fits everywhere!!!

KP and SD are available in sizes A and B, whilst still maintaining the same structure and dimensions. They are easy to install and maintain thanks to washable filters that are easy to access on both versions.

SD, despite being designed for built-in and therefore concealed fitting, can be controlled by the iSERIES™, universal remote control in either wireless or wired mode.



- Ceiling installation
- LED operation can be deactivated by remote control



- Condensation anti-drip system



ONLY  
18.9 cm!!!

The depth of only 19 cm and quiet operation at 24 dB(A), make these two iSERIES™ units an excellent solution for villas, offices, hotel rooms, restaurants and public spaces etc...



- Vertical installation



# CA

**Model:**

CA8FIA  
CA9FIB  
CA10FIC

CA, the cassette unit for false ceilings that we can often observe above our heads in public spaces, offices, shops and restaurants.

It is certainly also suitable for private dwellings as it was originally designed with this application in mind, however it is more common to see it used in service sector applications.

CA **(A)**  
**(B)**



Dimension A & B: HxLxD 296x575x575 mm  
Weight: A |19 kg - B | 20.5 kg

CA **(C)**



Dimension C: HxLxD 338x860x860 mm  
Weight: 22 kg

\* During 2013 also CA size D will be available



*very quiet:*  
**only 35 dB(A)**

*Heat exchanger in odourless inorganic hydrophilic aluminium*

# CA

		CA8 FIA	CA9 FIB	CA10 FIC
Air flow rate I.U. (el.-l.-m.-h.)	m <sup>3</sup> /h	470-500-600-700	500-530-630-750	680/840/1020/1140
Dehumidification	l/h	1,2	2,3	3,6
Fan speed	N°	Auto + 3 remote control settings		
Sound pressure I.U. (el.-l.-m.-h.)	dB(A)	35-37-40-44	35-37-40-44	41/44/45/46
Electrical power supply	V/Ph/Hz	230/1/50	230/1/50	230/1/50
Power input	kW	0,087	0,087	0,175
Current input	A	0,41	0,41	0,77
Liquid pipe diameter	mm (")	6,35(1/4")	6,35(1/4")	6,35(1/4")
Gas pipe diameter	mm (")	9,52(3/8")	12,7(1/2")	15,88(5/8")
Net weight I.U.	kg	19	20,5	22
Net dimensions I.U. (H./W./D.)	mm	296x575x575	296x575x575	310x760x760
Net dimensions grille (H./W./D.)		41x730x730	41x730x730	30x860x860

Available in sizes A and B, and with slightly larger dimensions (80x80) also in size C, this unit is built with great attention to detail: insulated metal, four flocked anti-condensation flaps, carefully calibrated fan, quality plastic grille and a large filter that is easy to access for cleaning.

**CA** is designed for air exchange with the outside, which is mandatory for installations in public spaces, and is equipped with a condensation discharge pump.

As with all the other units in the iSERIES™ range, **CA** is controlled using the universal remote control. In applications where this cassette unit is installed the remote control is able to express some of its more special features, such as the option for wired connection instead of wireless control and the ability to control groups of units, which is very useful for open space offices, restaurants, and hotel reception areas.



CA8/CA9

CA10



• Easy installation and discharge • Perfect integration!



• Flocked anti-condensation flaps



• Body in anti-corrosion metal



• Simple and convenient maintenance



# DS

**Model:**  
DSA10FIC

DS, the high prevalence ductable unit, to be combined with purpose built plenums with or without the aid of the three-way duct built into the unit.

DS ©



Dimensions: HxLxD 680x900x190 mm  
Weight: 23.5 kg

\* During 2013 also DS size D will be available



# DS

## DSA10 FC

Air flow rate I.U. (el.-l.-m.-h.)	m <sup>3</sup> /h	500/600/700/1000
Dehumidification	l/h	2,5
Fan speed	N°	Auto + 3 remote control settings
Sound pressure I.U. (el.-l.-m.-h.)	dB(A)	35-40-46-49
Electrical power supply	V/Ph/Hz	230/1/50
Power input	kW	0,114
Current input	A	0,51
Liquid pipe diameter	mm (")	6,35(1/4")
Gas pipe diameter	mm (")	12,7(1/2")
Net weight I.U.	kg	23,5
Net dimensions I.U. (H./W./D.)	mm	680 x 900 x 190

**DS**, as with the cassette units, this unit is mainly designed for use in service sector applications and is built with great care from carefully selected materials.

Available in size C, it is equipped with high quality centrifugal fans and a condensation discharge pump. It is also fitted with washable filters that are easy to access and can be controlled using the iSERIES™ universal remote control in wired or wireless mode.



- Plenum for ductling the air into 3 spaces



- Removable filters



- Perfect distribution



- Standard integration



# SDHV SMALL DUCT HIGH VELOCITY

**The Unico System**  
Small-Duct Central Heating & Air Conditioning

SDHV (Small Duct High Velocity) is an extension of the Technibel iSeries system that makes it possible to distribute air for cooling or heating through various flexible ducts connected through a main duct with one or more ductable indoor units.

The available indoor units will come in two sizes: 1218 (size B) and 2430 (size C).

Unit 1218 is of the "monobloc" type consisting of a single section that includes the part housing the fan and the part with the direct expansion coil. Instead unit 2430 is of the "modular" type consisting of two separate sections (fan + direct expansion coil) which must be coupled with special hooks during installation.

The main feature of this type of ductable systems is the possibility of distributing air inside the environments to be air-conditioned with tubes with a very small diameter (just 50 mm). This is possible thanks to the high speed of the air, about 5 m/s, leaving each terminal. The air distribution tubes are built to prevent the transmission of noise to the environments. They are made of woven nylon (a material that dampens noise by nature) and wrapped in a metal wire to ensure stiffness. Thanks to this expedient, sound pressure values are reached which are completely similar to those of the best wall mounted split units on the market today (approx. 21 dBA). Adjusting the air flow in the system is managed by the sophisticated DC Inverter electronics as in all the models of the Technibel iSeries range. In SDHV applications, the control system does not manage just the modulation of the compressor and the fan motor of the outdoor unit but also the modulation of the fan motor of the ductable unit so that the air flow is always a function of the requested heat load.

The result is an always optimal distribution of air which triggers an air mixing mechanism and guarantees a very uniform temperature distribution in the environments.

The air outlets may be of various shapes: circular (standard solution) or rectangular. The outlets may be installed on walls/ceilings and on the floor. Various finishings are available (various types of wood or aluminium), which make the SDHV terminals perfect for any environment.

There is a host of applications for these systems, all characterised by two great advantages: reduced visual impact and simple and quick installation.

The SDHV iSeries systems are well suited for domestic/residential environments, where the need for an uninvasive centralised system is a key design feature. Furthermore, with these systems it is possible to air-condition environments which were hardly feasible with traditional systems (split type) such as: bathrooms, kitchens, etc... In case of highly efficient pre-fabricated houses, the delivery outlets and the flexible hoses can be easily concealed directly in the wall at the time of construction.

iSeries SDHV is just as interesting when used for installations in the service sector (offices) or commercial (shops) environments. In these cases the possibility of using several indoor ductable units to create different climatic areas in an open space environment is an asset. Each indoor unit will be individually adjusted with its digital remote control.

The installation is always very flexible and not very difficult. Except for the main duct, all the accessories (flexible tubes, delivery outlets, assembly kit) are supplied. The flexible hoses also make installation very easy by limiting the typical worksite problems to the minimum.

## TOP FEATURES

- 5 m/s of speed from each terminal
- Distribution tubes 50 mm diameter
- 30% extra dehumidification
- Less loss of heat in the ducts (reduced pass-through area and improved insulation)
- Environmental temperature difference 1°C

SDHV i1218



SDHV i2430



\* During 2013 also SDHV size D will be available

# SDHV

**SDHV i1218**

**SDHV i2430**

		<b>SDHV i1218</b>	<b>SDHV i2430</b>
Air flow rate (min./max)	m <sup>3</sup> /h	340/680	510/1020
Static pressure (min/max)	Pa	50/550	50/625
Fan speed	N°	Auto	Auto
Sound pressure	dB(A)	41	44,5
Electrical power supply	V/Ph/Hz	230/1/50	230/1/50
Power input	kW	0,37	0,37
Current input	A	0,51	0,51
Liquid pipe diameter	mm (")	6,35(1/4")	6,35(1/4")
Gas pipe diameter	mm (")	12,7(1/2")	12,7(1/2")
Net weight I.U.	kg	42	56
Net dimensions I.U. (H./W./D.)	mm	305 x 965 x 508	445 x 698 x 635

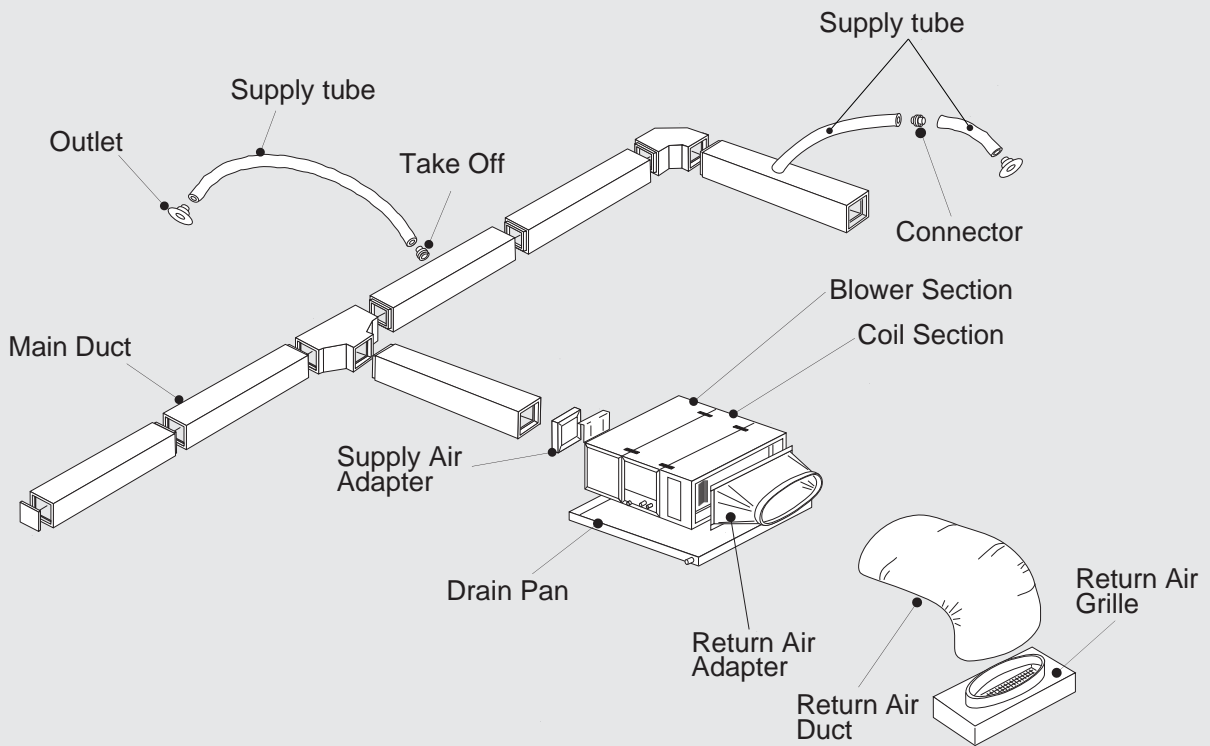

Flexible silenced tube



Aluminium flexible tube (optional)



Standard outlet to distribute air into the environment



Optional outlets in different finishes

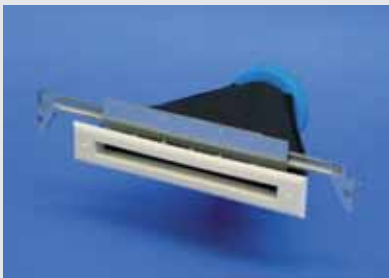

Rectangular outlet



90° attachment rectangular outlet



Perimeter installation



Ceiling installation





Return air adapter



Return air duct



Return air grille with filter



For the operation of each indoor unit it is necessary to install a control box containing the electronic management boards. The control box may be placed in two different points according to installation requirements. The connection procedure is simple and fast. The control box is also provided with an infrared remote control with its own receiver.



Another great innovation introduced in the field of the SDHV systems thanks to iSeries, is the possibility of multi unit configuration. IT IS possible to connect several indoor units to an outdoor unit of a suitable size in a typical multi-split configuration. In this way, it is very simple to manage two different areas (also an open space) without having to resort to motorised blinds which act on the main duct. Each area is managed through a dedicated indoor unit connected with its own universal remote control, which will work as a digital thermostat. The great advantage of this solution is that it simplifies both installation (no dampers, no area thermostats) and management (one remote control against several thermostats).





#### **“EASY Mode” buttons**

The new layout lets you simply and quickly choose the start up and the two operating modes, cooling and heating



#### **“WIRED Mode”**

The remote control may also be used as a wired command by simply removing the protection lid and connecting the communication cable to the indoor unit.

## **Wireless or wired Universal Digital Interface**

All air-conditioner operating parameters can be controlled from the remote control: operating modes (auto or cooling only, heat pump only, dehumidification only, fan only), 1h and 24h timer, desired temperature, ambient temperature reading, TiO<sub>2</sub> filter activation (where fitted), fan speed, flap oscillation for optimum air distribution in the room and economy or night functions.

Many operations can be set automatically or managed when needed, including the deactivation of the LED indicators for those that prefer complete darkness at night.

**Adjustable set point from 10° to 32° C**  
*both in cooling and heat pump modes*

- **Dual transmitter**

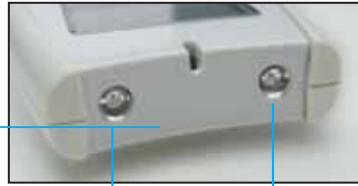

- **Wide range of operation.** The presence of a dual infrared transmitter ensures a very wide range of operation: just place the remote control where you like for "made-to-measure" comfort in that area.

- **Built-in temperature sensor.**

- **Wide display with graphic symbols and alphanumeric indicators.**

- **iFeel function**

a comparative function that ensures optimum temperature settings based on the values read at the remote control sensor, the sensor in the indoor unit and the resulting ambient temperature stratification conditions, which are always different from one room to another.

- **iFlap Function**

The air flow can be released into the room in an "intelligent" way based on whether the unit is set to heating or cooling mode, thanks to a special system that controls the oscillation of the horizontal.

- **Hi power (turbo) function**

when maximum power is required straight away.

- **"ECO" function**

Unlike the "Hi power" function, for those who want instant maximum power, this function may be activated to optimise the operation of the outdoor units and the ventilation by reducing consumption and noise, exploiting all the modulation capacities of the inverter units.



- **Multi directional**

The remote control can be set to control four different units in an open space for unified control, or customised according to temperature, timer, operating mode, and all other functions.

### One for all

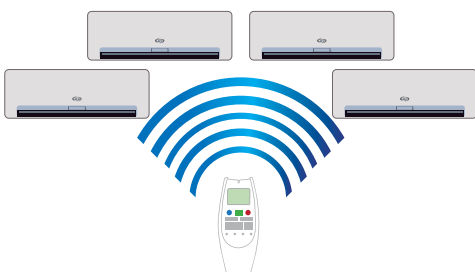

### One to One

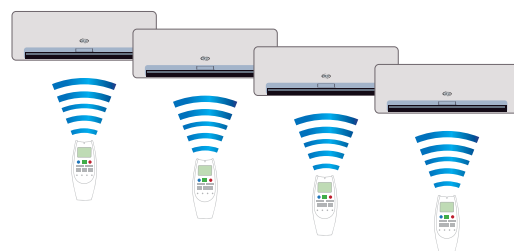



# HKE Hydrokit

*Hydrokit HKE, available in sizes B, C and D, is the indoor unit to be combined with the iSERIES™ outdoor units to create heating and air-conditioning solutions with underfloor, wall or ceiling mounted radiator systems.*

The unit is already equipped with:

6 litre expansion tank

Circulation pump (compatible with the parameters requested by the new standard 2013) at 3 selectable speeds during start up,

Supplementary heating elements. The elements may be activated through a thermomagnetic switch in two steps: 2 + 2 kW; 2 + 4 kW. All the elements may be unpowered completely but, to guarantee the correct operation of the unit in every condition, it is advisable to leave one 2 kW step active. The control system is responsible for the electric backup management, which will only activate when necessary, based on the outdoor temperature or in case the temperature of the water in the system is too low.

The HK unit is easy to install thanks to its small size and may be installed up to 50 m with an additional load of refrigerant.

Hydrokit must be powered separately (it is not possible to take power from the outdoor unit) in both mono-phase and three-phase mode according to the network availability; it is necessary to connect HK always on line A of the outdoor unit.

The unit is provided with Aquaset Climatic Control weather compensator included and with water filter.

## HKE MATCHING

- B** GR9FI50emx
- B** GR9FI65emx
- B C** GR9FI80emx
- B C D** GR9FI110emx

In case of installations in a mixed Air/Air + Air/Water configuration, the possible combinations between the various indoor units are broadened according to the application (to be defined according to the project).

# HKE

		HK BE	HK CE	HK DE
2 stage supplementary electric backup	kW	4/6	4/6	4/6
Rated Input	A	27	27	27
Protected Rating	A	32	32	32
Electrical power supply	V/Ph/Hz	230/1/50	230/1/50	230/1/50
Sound pressure I.U.	dB(A)	38	38	38
Water Connections	inch	3/4" M	3/4" M	3/4" M
Gas Connections	inch	1/4" - 1/2"	1/4" - 1/2"	1/4" - 1/2"
Net weight I.U.	kg	41	41	41
Net dimensions I.U. (H/W/D.)	mm	826x527x284	826x527x284	826x527x284
Operating range in heating		-20°C / +35°C	-20°C / +35°C	-20°C / +35°C

- 1 - Plate type heat exchanger.
- 2 - Electric heater:

- 4 kW : 1<sup>st</sup> stage = 2 kW; 2<sup>nd</sup> stage = 2 kW.
- 6 kW : 1<sup>st</sup> stage = 4 kW; 2<sup>nd</sup> stage = 2 kW.

- 3 - Automatic air vent valve.
- 4 - Water pressostat.
- 5 - Automatic reset safety thermostat.
- 6 - Manual reset safety thermostat.
- 7 - Circulator pump.
- 8 - Surge tank.
- 9 - Manual air vent valve.
- 10 - Hydraulic system pressure gauge.
- 11 - Safety valve.
- 12 - Flow detector.
- 13 - Water inlet connection.
- 14 - Water outlet connection.
- 15 - Filling / drainage of the water system.
- 16 - Safety valve drain connection.
- 17 - Flare gas connector.
- 18 - Flare liquid connector.
- 19 - Electrical cable passage.
- 20 - Water system pressure tap for flow control.
- 21 - Cover.
- 22 - Communication module access window.
- 23 - Electrical box

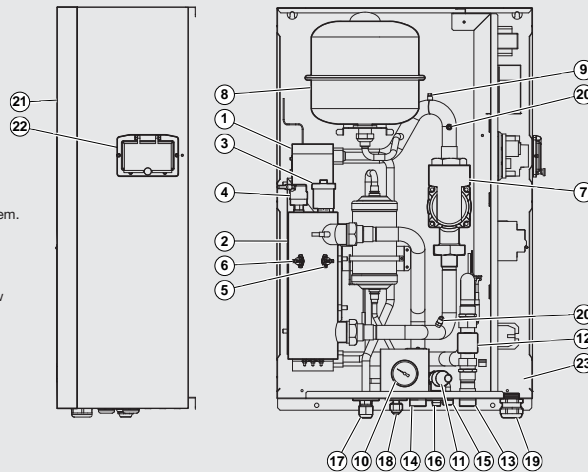

**Materials:**

- Copper piping.
- Stainless steel water heat exchanger.
- Painted sheet metal cabinet.

OUTDOOR  
SENSOR

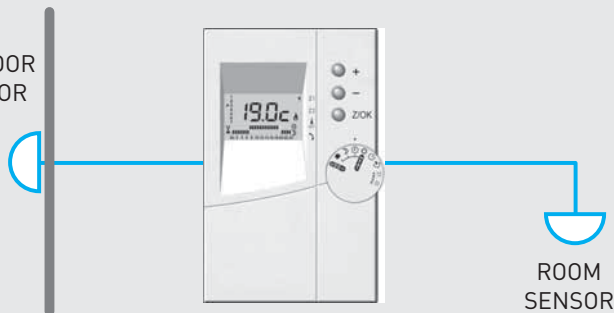

ROOM  
SENSOR

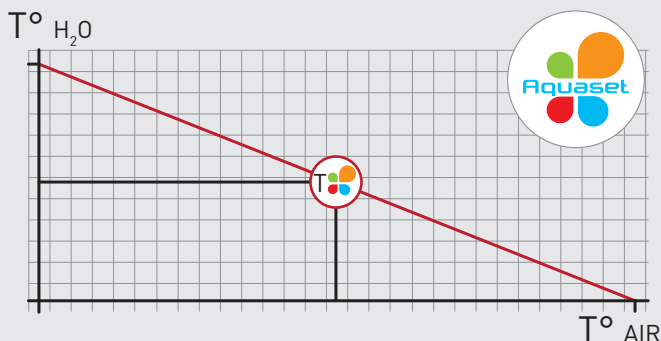

Each hydrokit unit features the **Aquaset** management electronics inside as standard. The electronics in charge of managing the delivery temperature of the water in the system. Aquaset deals with establishing the optimal water outlet temperature based on a series of parameters that may be set during start up (maximum temperature on the return, minimum regional temperature, etc...), the outdoor air temperature detected and the set environment temperature. Based on this, it communicates with the iSeries electronics to provide the necessary power to reach this value.

Aquaset manages various system layouts. Some examples: 1 or 2 underfloor zones, 1 fancoil zone and a floor area and 1 low temperature radiators zone.

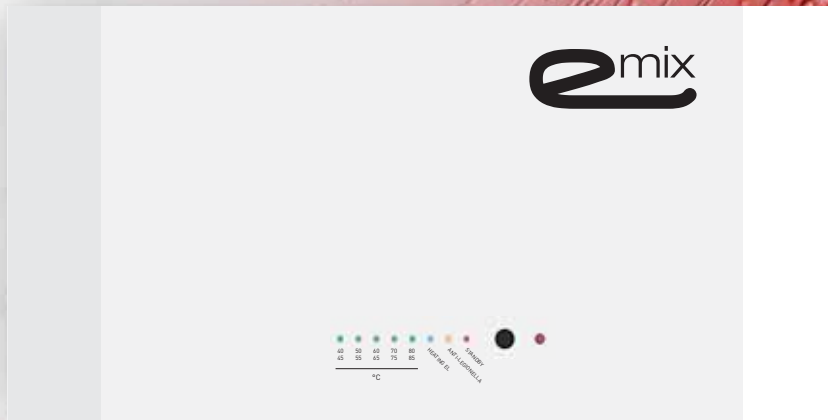

*eMix is the innovative indoor unit in the iSERIES™ range, able to provide domestic hot water from a thermo-dynamic source all year round, i.e. independently of the system's operating mode.*



EMIX



CONTROL PANEL



EMIX TANK 220



EMIX TANK 300

# eMix

## E MIX \*

Electrical power supply	V/Ph/Hz	230/1/50
Minimum power input	W/A	4 / 0,05
Maximum power input	W/A	70 / 0,53
Water connections	inch	3/4" G - 3/4" G
Gas connections	inch	3/8" - 3/8"
Net weight I.U.	kg	10
Net dimensions I.U. (H./W./D.)	mm	268x527x285

A 1'G hydraulic filter is provided to be placed upstream of the eMix, if not already present in the system.  
A water softener is advised to reduce the loss of performance of the heat exchanger. eMix inlet and outlet taps are advised. Add pressure reducers for high pressures.

\* For additional information, please visit the Technibel website

eMix and eMix tank are two components of the iSeries system which are added to the very broad range of indoor units. The purpose of eMix and eMix tank is to produce domestic hot water through storage, using the energy produced directly from the heat pump (therefore renewable energy) and providing the service at the same time as heating and cooling the environments, thanks to the various air and/or hydronic indoor units of the iSeries range. eMix and eMix tank differ by type of installation which they are allocated, but not by type of service or performance; they both realise your dream: hot water up to thermo-dynamic 80°C when the heat pump is in both heating and cooling mode, without priority cycles or temporary interruption of the cooling service.

connects to any electric boiler

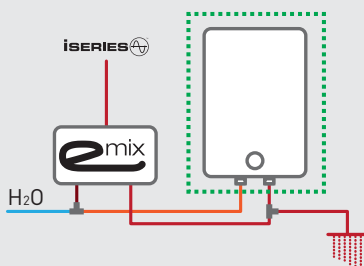

connects to any tank suitable for domestic hot water

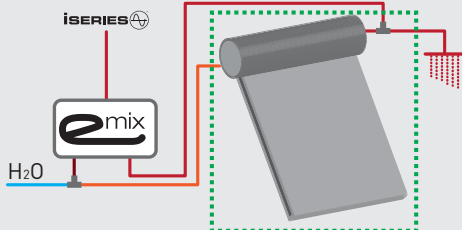
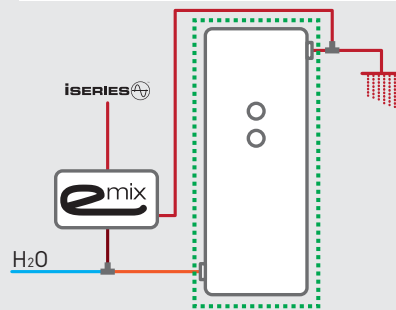

connects to any natural circulation solar tank suitable for domestic hot water

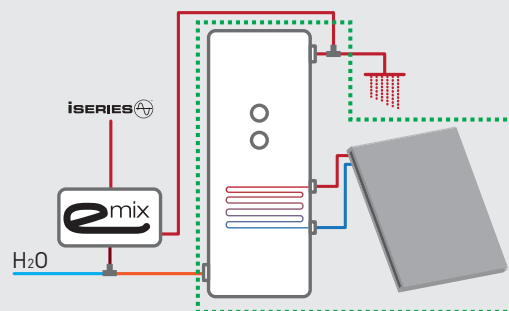

connects to any forced circulation solar tank suitable for domestic hot water

the components provided by third parties are outlined with green dashes

eMix and eMix tank must be connected to an outdoor unit of the iSeries range equipped with special software and a specific cooling connection dedicated to eMix. The compatible outdoor units are\*:

#### ALL THE ISERIES EMX OUTDOOR UNITS



The following diagram illustrates the concept exposed on the previous page and shows a system configuration where three indoor direct expansion units, a hydrokit for a floor system and an eMix tank co-exist, all connected to a G110emx.

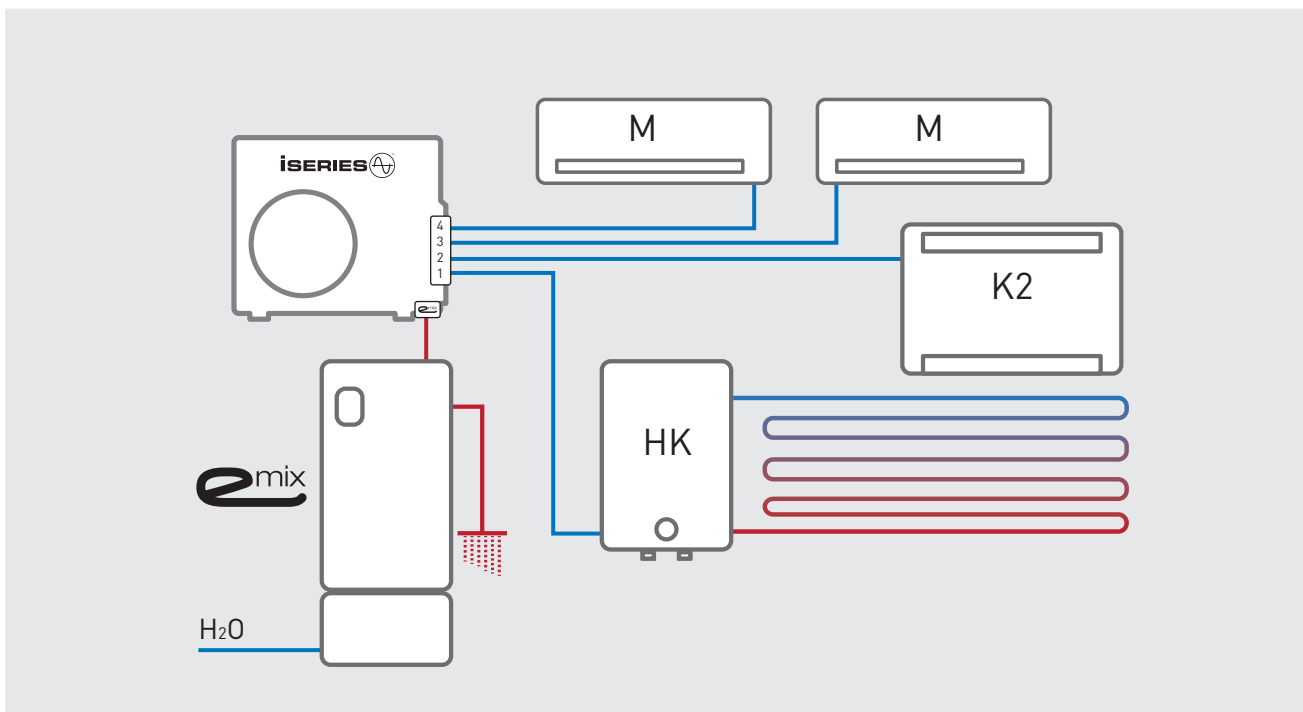

eMix always works in heating mode also if the other units are working in cooling mode; when these work in this mode, eMix is able to recover the heat which would otherwise be lost in the outdoor air, significantly increasing the energy efficiency of the entire system.

There are several possible configurations with eMix and the one represented in the previous figure is just one of many.

In general we may summarise them with the following concept: eMix is a component that may be connected to the other types of indoor units of the iSeries range at the same time without specific limitations by using the special cooling connection for eMix and duly considering the length of the eMix pipe to be added to the total length set by the outdoor unit (we advise a specific insulation of the eMix pipes to guarantee the minimum dispersion of energy)

eMix may also be connected to a standard cooling connection and normally dedicated to the indoor units; in this case it is not possible to perform the heating service of the domestic water when the system works in cooling mode. For this reason, the above mentioned configuration is advised only in the cases where eMix is used only as mono-split heat pump dedicated to domestic water (typical case of combination with the G30emx outdoor unit) or with other eMixes to form a kind of battery for the production of large quantities of domestic hot water from a renewable source (up to 4 eMixes for a total of 1200 lt).

eMix is compatible with any heat solar system. This huge flexibility is unique and lets you apply this technology also to the natural circulation solar systems that are very popular in Mediterranean countries. Instead eMix tank is a turnkey solution fitted with a tank that contains a special AISI316L stainless steel exchanger inside for solar systems.

\* All the previous models can not support this new device for the production of domestic hot water.



eMix is able to manage any third party tank, including electric boilers; this unique feature makes eMix an excellent solution not just for new systems but also to protect existing investments.

In case the new or existing tank is equipped with one or more electrical elements (up to 3 for mono-phase or three-phase management), eMix uses them as a source of backup energy to the heat pump if this is temporarily inactive or if the outdoor temperature is so low to require extra energy; these functions can be activated during installation and can be de-activated by the end user with a special command on the eMix function button.

eMix tank is already equipped with three 1 kW electrical elements, also managed by the electronics and that can be enabled or disabled by the end user.

eMix and eMix tank must always be connected to the electrical power supply in a separate manner compared to the connection of the outdoor unit of the iSeries system, which they are connected to with only the shielded cable of the two-wire communication bus as with all the other indoor units.

eMix and eMix tank do not have any functional relation with the heating of the environment through internal air units or hydrokits and related hydraulic system on the hydronic side; eMix and eMix tank have the sole function of producing domestic hot water in every operating and applicative condition, with water reaching 80°C completely from a renewable source, i.e. without the aid of electrical elements; it is clear that if a solar system is connected to eMix, this will facilitate the work of eMix and the heat pump even further by taking the system's energy efficiency to its maximum.

eMix and eMix tank are built inside a white metal cabinet that is easy to integrate in any home or office and looks good next to other white goods such as fridges, electrical boilers, etc...

The two devices are provided as standard with any component necessary for their regular operation and only require some external hydraulic components. These components are usually selected and provided by the installer when installing a boiler or a solar system (e.g. a mixing unit or a vent valve for excess pressure...)

eMix and eMix tank have been designed to work with water pressures up to 10 bars and thus are compatible with water networks in every European country. They comply with the strictest European standards for the double insulation between the circulation of domestic water and the refrigerant.

eMix and eMix tank are fully automatic and the end user must only decide the maximum temperature of the domestic water. This can be done by using the special eMix function key. A series of coloured LEDs will indicate the temperature of the water and some special operating conditions, for example the anti-legionella cycle, the active electrical elements, the deactivated heat pump etc...

Therefore eMix and eMix tank must not be set with complicated menus for operating cycles or environment heating priority. These two very complex units are simple to use.

eMix and eMix tank have a very fast reactivation cycle from cold to hot water as they do not work by water temperature stratification in the tank and, thanks to the new operating principle, can reach up to 80°C in just 5 hours starting from a water network temperature of around 10°C, with the single renewable source without the aid of electrical elements or solar panels.

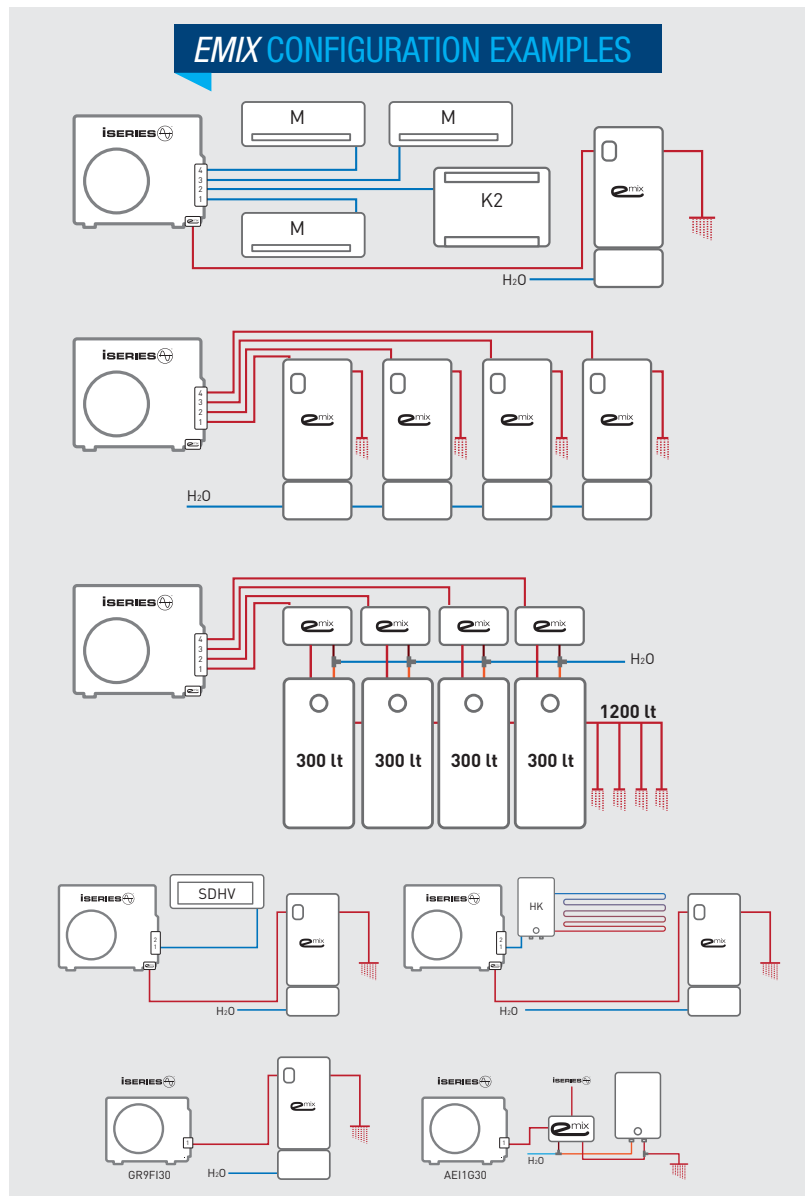





www.technibel.com



headquarter  
Via Varese, 90  
21013 Gallarate (VA) ITALY  
Tel: + 39 0331 755111  
Fax: + 39 0331 776240  
[www.technibel.com](http://www.technibel.com)

702013303 - 02/2013

N.B. The manufacturer assumes no responsibility for any errors or inaccuracies in the content of this catalogue, and reserves the right to make any necessary changes to its products, at any time and without notice, for technical or commercial reasons.