

USi-safety evaluation unit

USI-F262-2E5-V19-S2D3



- Category 3 PL d (EN ISO 13849) for each ultrasonic transducer without redundancy
- Multiple device installation possible, no mutual interference (no cross-talk)
- Safety outputs OSSD
- Adjustable sound cone
- Temperature compensation
- Parameterization, commissioning and reporting via USi-safety parameterization software

Evaluation unit exclusively for the ultrasonic sensor system USi-safety



Dimensions

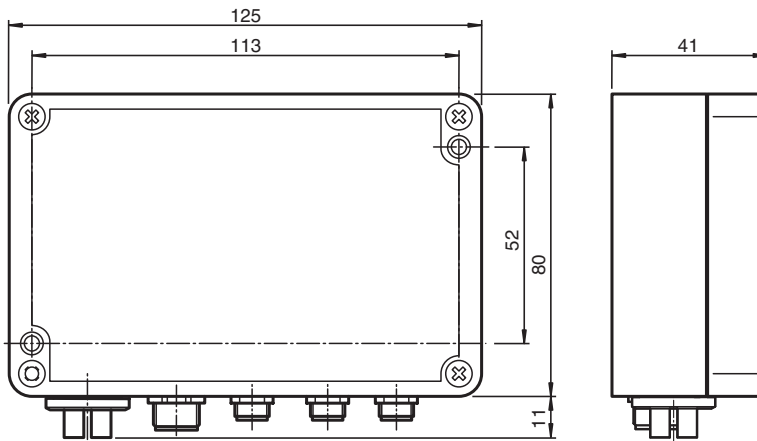

Technical Data

General specifications		
Type		USi-safety evaluation unit
Sensing range		1 ... 250 cm typ. 200 cm
Adjustment range		1 ... 250 cm
Dead band		1 cm
Object size		typ. Ø 1 cm
Transducer frequency		typ. 103 kHz
Resolution		1 cm
Target velocity		axial (max.): typ. 2 m/s (up to 2.5 m/s)
Repeat accuracy		± 0 cm
Hysteresis	H	typ. 0 cm (0 up to SP1/10)
Temperature influence		automatic or manual temperature compensation available , without temperature compensation: 0.17 %/K
Functional safety related parameters		
Performance level (PL)		PL d
Category		Cat. 3
Reaction time		typ. 100 ms (99 ... 660 ms)

Release date: 2023-02-15 Date of issue: 2023-02-15 Filename: 70131322_eng.pdf

Refer to "General Notes Relating to Pepperl+Fuchs Product Information".

Pepperl+Fuchs Group
www.pepperl-fuchs.com

USA: +1 330 486 0001
fa-info@us.pepperl-fuchs.com

Germany: +49 621 776 1111
fa-info@de.pepperl-fuchs.com

Singapore: +65 6779 9091
fa-info@sg.pepperl-fuchs.com

PEPPERL+FUCHS

Technical Data

Recovery time		typ. 990 ms (330 ... 3300 ms)
MTTF _d		316 a
Diagnostic Coverage (DC)		87 %
Electrical specifications		
Fusing		2 A , slow
Operating voltage	U _B	21 ... 28 V DC typ. 24 V DC
No-load supply current	I ₀	≤ 150 mA
Power consumption	P ₀	max. 3.6 W
Interface		
Interface type		USB 2.0
Inputs		
Input type		2 inputs for ultrasonic transducers 1 input for temperature sensor
Output 1		
Output type		safety output OSSD Normally closed, Power FET PNP OSSD 1.1 and OSSD 1.2
Switching voltage		max. U _B
Switching current		150 mA per output
Output 2		
Output type		safety output OSSD Normally closed, Power FET PNP OSSD 2.1 and OSSD 2.2
Switching current		150 mA per output
Output 3		
Output type		Normally open/normally closed switchable, Power FET PNP signal output OUT1
Switching voltage		max. U _B
Switching current		150 mA
Output 4		
Output type		Normally open/normally closed switchable, Power FET PNP signal output OUT2
Switching voltage		max. U _B
Switching current		150 mA
Compliance with standards and directives		
Standard conformity		
Standards		IEC 60947-5-2 IEC 60204-1 EN ISO 13849 IEC 61326-3-1:2007 IEC/CISPR 11 group 1, class A
Approvals and certificates		
CCC approval		CCC approval / marking not required for products rated ≤36 V
Ambient conditions		
Ambient temperature		-30 ... 50 °C (-22 ... 122 °F)
Storage temperature		-40 ... 85 °C (-40 ... 185 °F)
Mechanical specifications		
Connection type		Connector plug
Degree of protection		IP65
Connection		for power supply and outputs: connector plug M12, 8-pin, connection line max. 30 m for temperature sensor: socket M8, 6-pin for ultrasonic transducer: for each socket M8, 3-pin for parameterization: socket Mini USB
Material		
Housing		diecast aluminum
Mass		450 g
Factory settings		
Default setting		See the original instructions

Release date: 2023-02-15 Date of issue: 2023-02-15 Filename: 70131322_eng.pdf

Refer to "General Notes Relating to Pepperl+Fuchs Product Information".

 Pepperl+Fuchs Group
www.pepperl-fuchs.com

 USA: +1 330 486 0001
fa-info@us.pepperl-fuchs.com

 Germany: +49 621 776 1111
fa-info@de.pepperl-fuchs.com

 Singapore: +65 6779 9091
fa-info@sg.pepperl-fuchs.com

 **PEPPERL+FUCHS**

Characteristic Curve



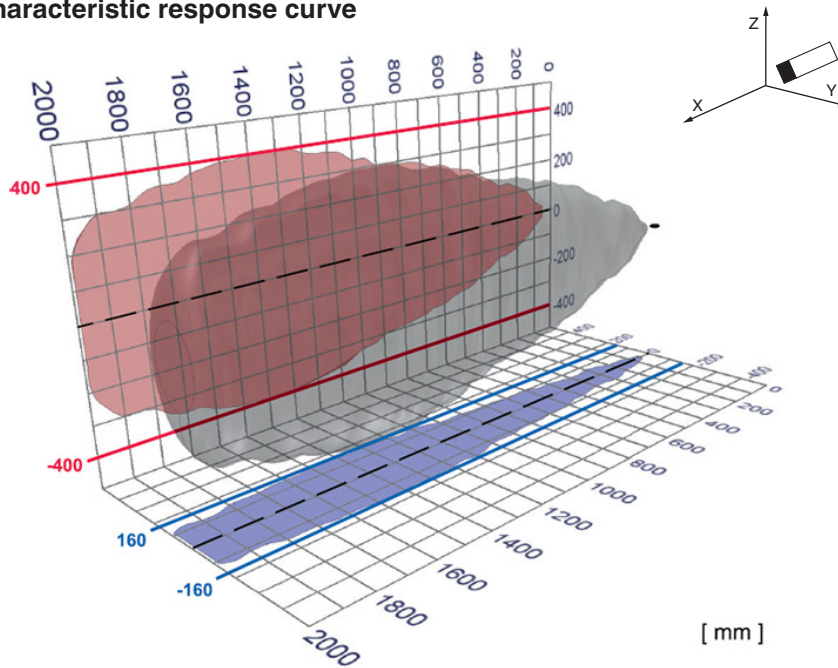



Characteristic response curve



Commissioning

This component is only intended for use in conjunction with the ultrasonic sensor system USi-safety. Further details, mounting and commissioning instructions for the safe ultrasonic sensor system USi-safety can be found in the original instructions on the respective product page at www.pepperl-fuchs.com.

Matching System Components

	USI2500-27X13E-1,5M-V3	Ultrasonic transducer with cable 1.5 m, exclusively for the USi-safety evaluation unit
	USI2500-27X13E-3M-V3	Ultrasonic transducer with cable 3 m, exclusively for the USi-safety evaluation unit
	V19-G-BK2M-PUR-U/ABG	Female cordset single-ended M12 straight A-coded, 8-pin, PUR cable black, shielded, UL approved
	USI-MH-27X13-V-01	Vertical mounting bracket exclusively for the USi-safety ultrasonic transducer
	USI-MH-27X13-H-01	Horizontal mounting bracket exclusively for the USi-safety ultrasonic transducer
	USI-TEMP-1,5M-V312	Temperature sensor exclusively for the USi-safety evaluation unit
	USB-AS-2M-PVC-USB-B	Adapter cable USB-A plug straight to Mini-USB-B plug straight 4-pin, PVC cable black, shielded

Release date: 2023-02-15 Date of issue: 2023-02-15 Filename: 70131322_eng.pdf

Connection

Connector X1	Signal	Pin	Circular connector
Supply voltage	+U _S , -U _S	2, 7	
Safe output 1.1	OSSD 1.1	1	
Safe output 1.2	OSSD 1.2	3	
Safe output 2.1	OSSD 2.1	4	
Safe output 2.2	OSSD 2.2	5	
Signal output 1	OUT 1	6	
Signal output 2	OUT 2	8	

Release date: 2023-02-15 Date of issue: 2023-02-15 Filename: 70131322_eng.pdf

Refer to "General Notes Relating to Pepperl+Fuchs Product Information".