

gesis[®] FLEX
Decentral rumautomation
Modulær – Kompakt – Stikbar

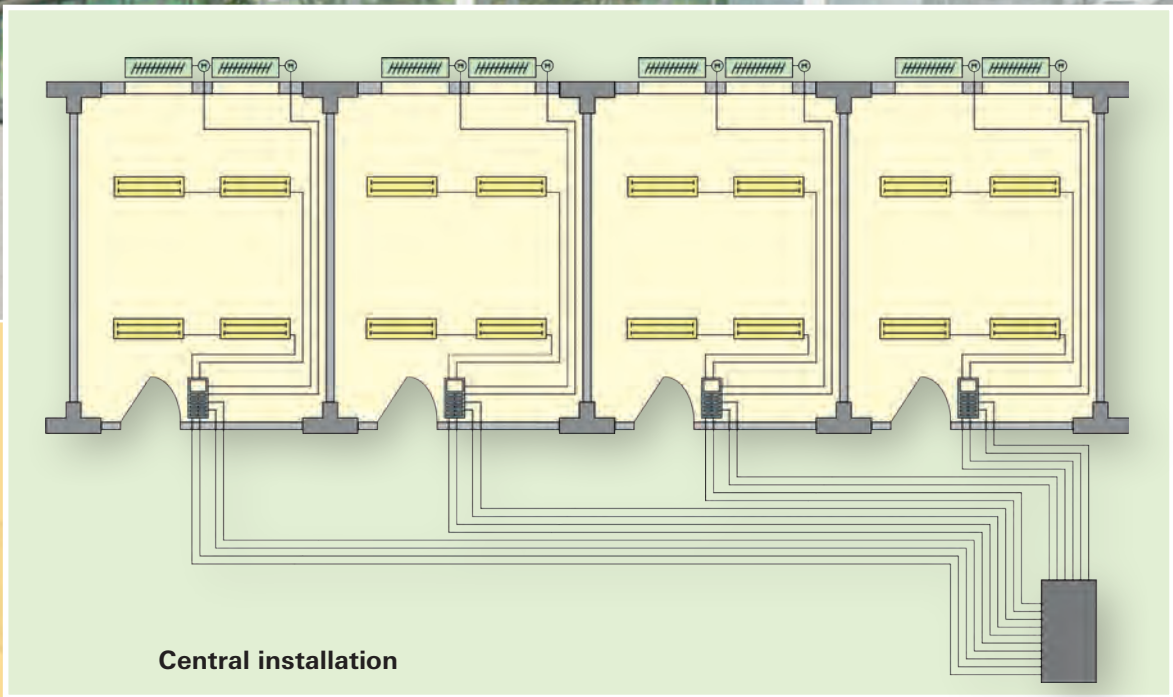

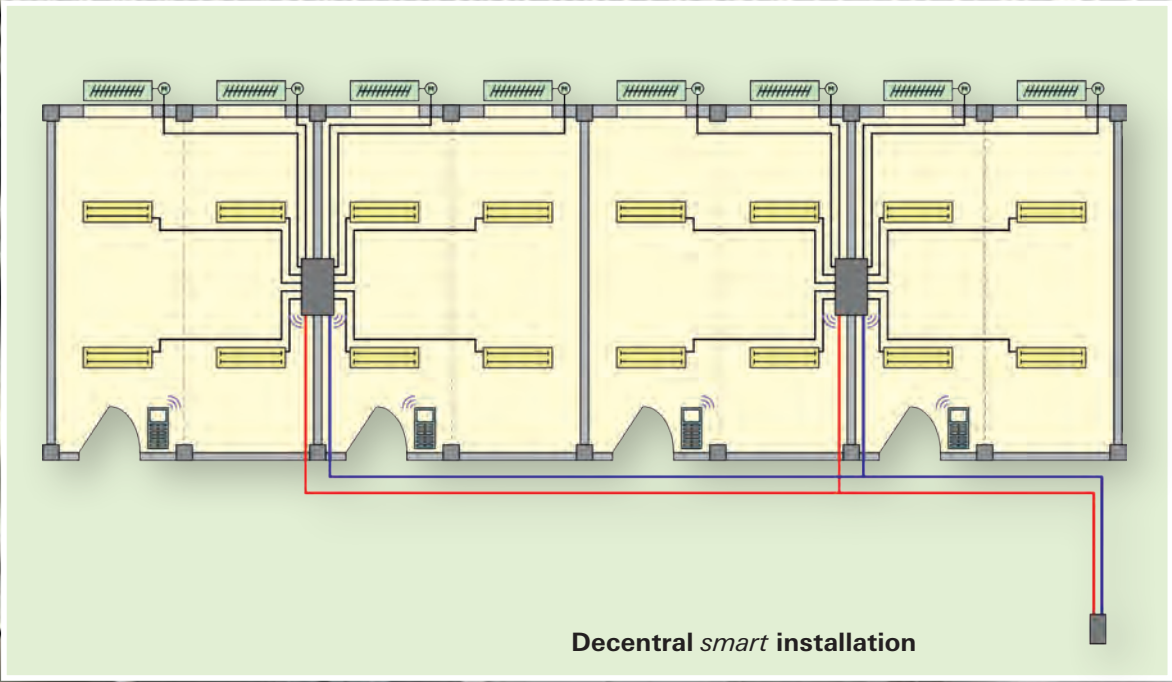
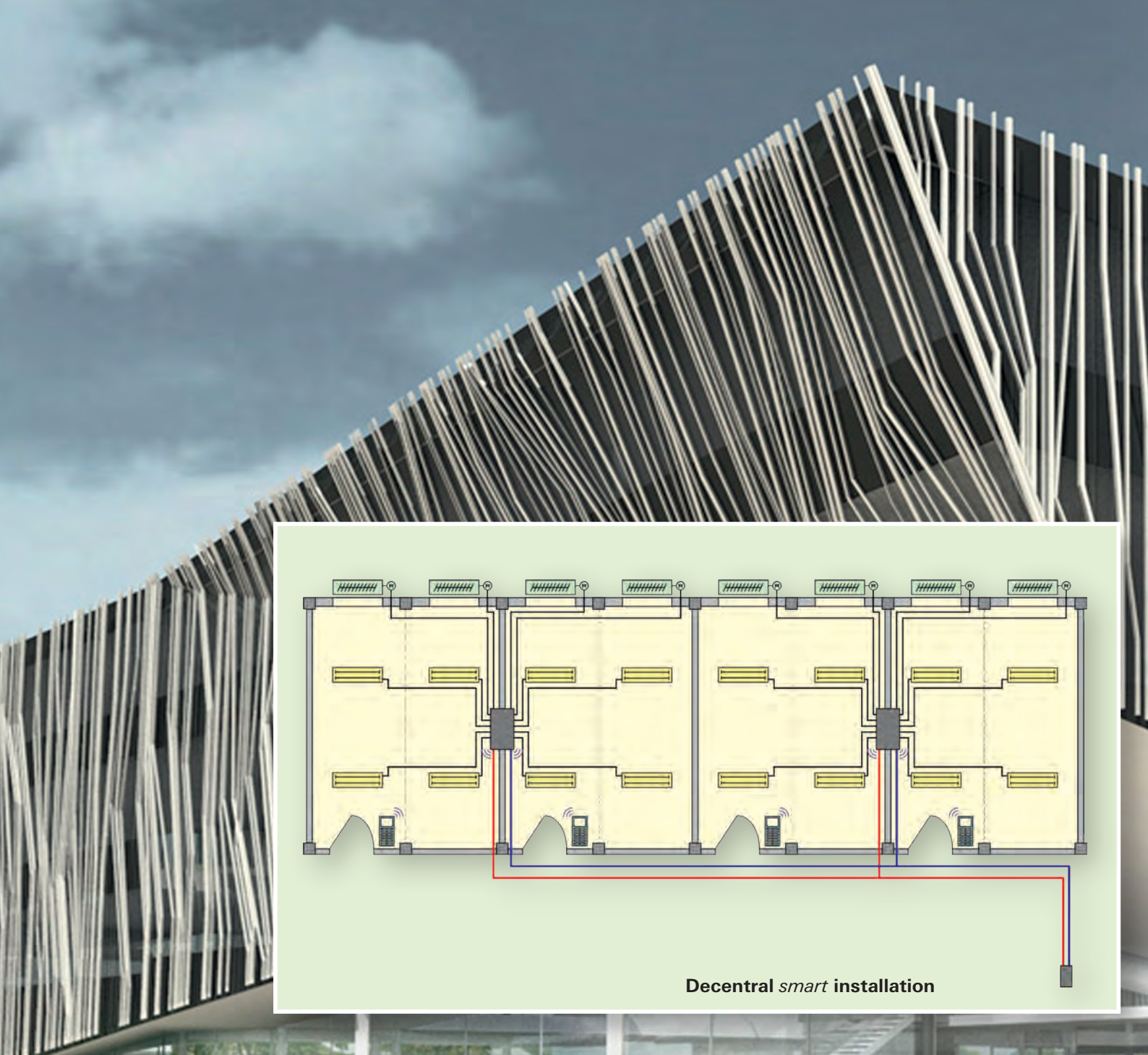

gesis® FLEX

Fremtidens rumautomatik

Decentral rumautomatik sætter nye standarder med hensyn til fleksibilitet, sikkerhed og effektivitet.

Med det modulære og ekstremt fleksible **gesis® FLEX** system fra Wieland Electric, der byder på TOP løsninger. Mulighed for styring af markiser, skygge, lys, varme, kulde, ventilation og kontakter, samt en lang række af andre ønsker i bygningsautomatik.

Konsekvent brug af standarder som KNX, EnOcean, DALI og SMI samt det kompakte og stikbare system, øger rentabiliteten og bæredygtigheden i enhver ejendom.



gesis[®] FLEX Highlights

Forskellen ligger i designet.

Alsidig

- 15 forskellige udvidelsesmoduler
- EnOcean og SMI Gateway
- HVAC

Kompakt

- Fladt design
- Kan tilpasses til alle nybyggeri områder (gulv, væg, loft/dæk)
- Let at integrere i nybyggeri eller ved renovering af eksisterende bygninger

Modulær

- Kun nødvendige funktioner installeres
- Kun en fysisk adresse
- 6 udvidelsesmoduler pr. basis modul der kan kombineres frit

Nem planlægning

- Kan planlægges i moduler
- Standard funktioner
- Standard moduler - ingen projekt specifikke produkter
- Ingen kabeldiagrammer

Nem installation

- Installation i EDB gulve eller på/under kabelstiger
- Tilslutning af kabler fra en side
- Kvik monteregrammer

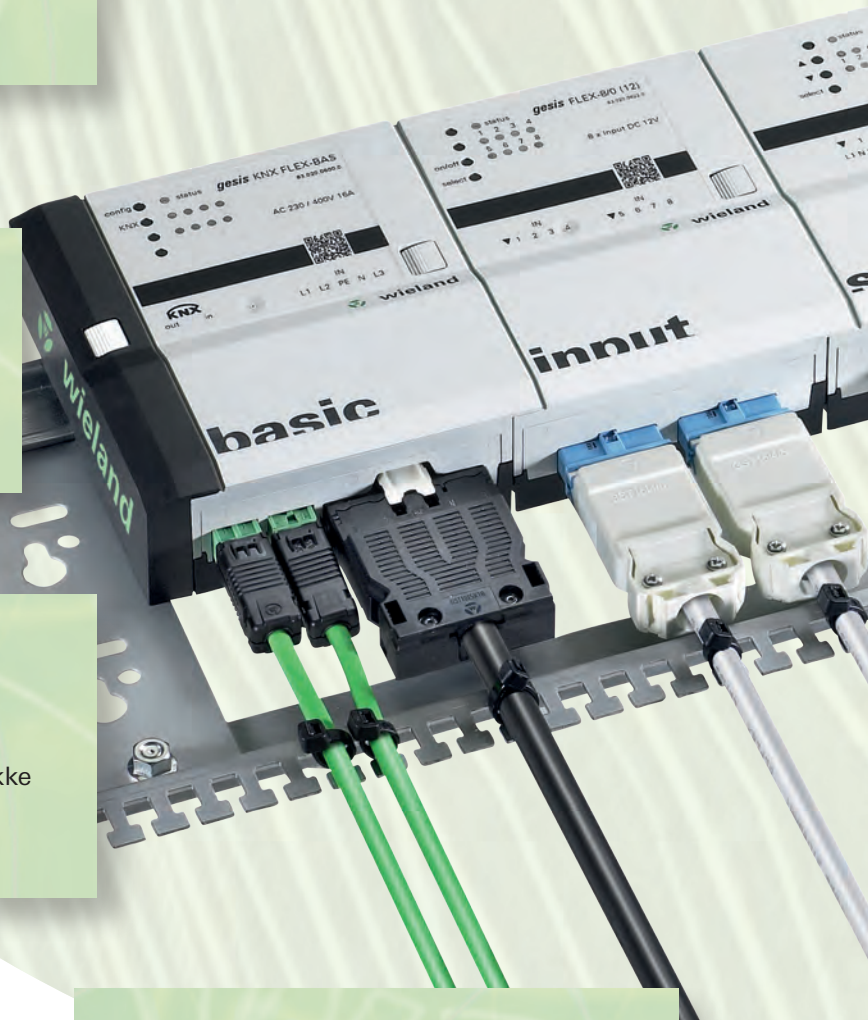

Stikbar

- 100% stikbart modulært system
- Stikbare input/output kabler
- Hurtig og fejlfri installation

Decentral

- Markant reduktion i kabel forbrug
- Fuld funktionalitet ved bus fejl
- Mindre fordelertavler og teknikum

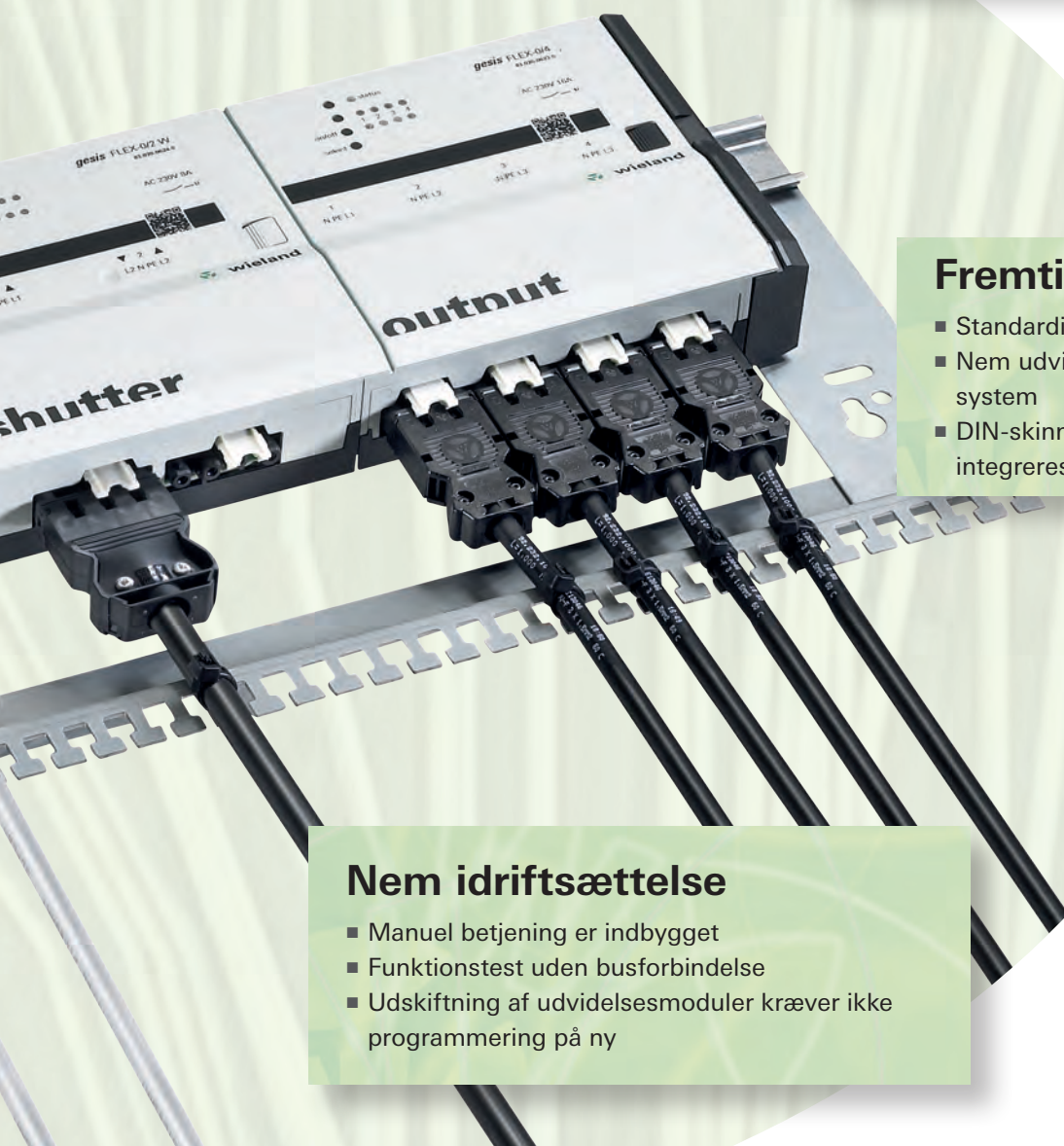

Fremtidssikker

- Standardiseret systemer
- Nem udvidelse p.g.a. det stikbare system
- DIN-skinne monteret komponenter kan integreres

Nem idriftsættelse

- Manuel betjening er indbygget
- Funktionstest uden busforbindelse
- Udskiftning af udvidelsesmoduler kræver ikke programmering på ny



enocean®



Loft

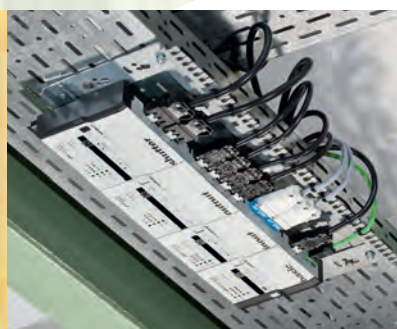

Kabelbakke

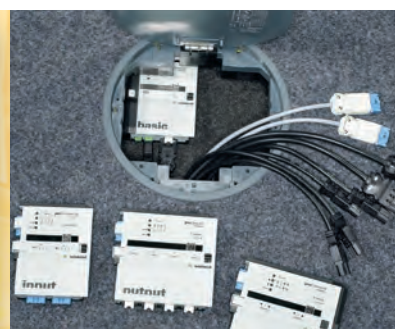

Gulv



Kontorbygninger

Applikation

Kompakt, modulær og stikbar installation og rumautomation for

- Kontorer
- Mødelokaler
- Laboratorier og testfaciliteter
- Kantiner

Løsning

- Decentral og modulær rumautomation med **gesis®FLEX**
- Dagslys afhængig lysstyring
- Lokal og centraliseret styring af solafskærmning
- Løsning for installation i gulvet, på væg - loft og dæk.

Fordele

- Klar og lokal installation af de enkelte rum
- Hurtig, enkel og fejlfri planlægning og installation
- Fladt design for installation, også i mindre installationsrum
- Ganske lidt programmering for at ændre anvendelsen
- Flexibiliteten sikrer på lang sigt ejendommens værdi

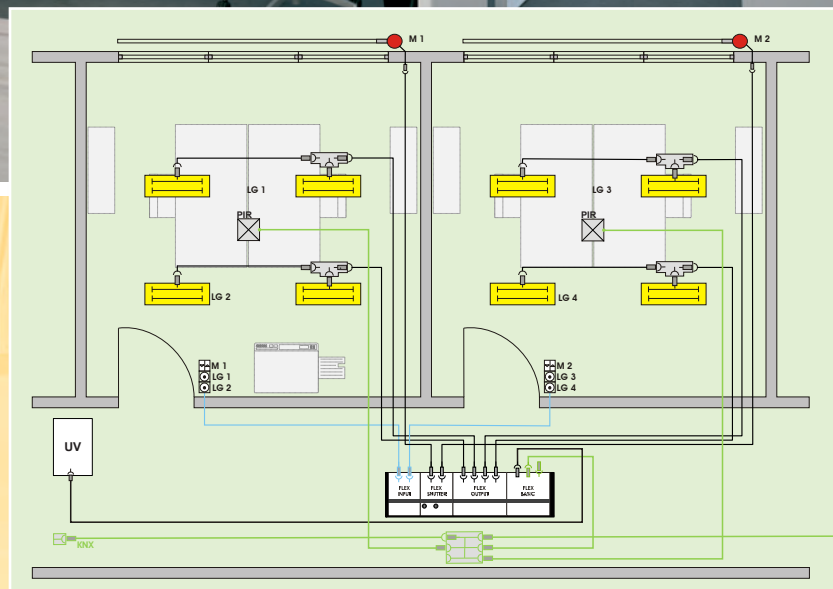

Kontorer

- Behovsorienteret lysstyring
- Markisestyring med lokal sikring
- Integration af konventionelle kontakter





Udannelses- og konferencecentre

Applikation

Kompakt, modulær og stikbar installation og rumautomation for:

- Klasseværelser
- Lærerværelser og administrative kontorer
- Gymnastik og sportshaller
- Pause og fællesrum

Løsning

- Decentral, modulær rumautomation med **gesis®**FLEX
- Tilstædeværelses kontrol for optimering af bl.a. belysning og rumtemperatur. Dermed opnås optimering af energiforbruget.
- Styring af solafskærmning

Fordele

- Hurtig, enkel og fejlfri planlægning og installation
- Reduktion af energiforbruget giver bæredygtighed
- Decentral rumautomation, ideel ved renovering
- Enkel konfiguration
- Høj funktionalitet for bygningsautomation

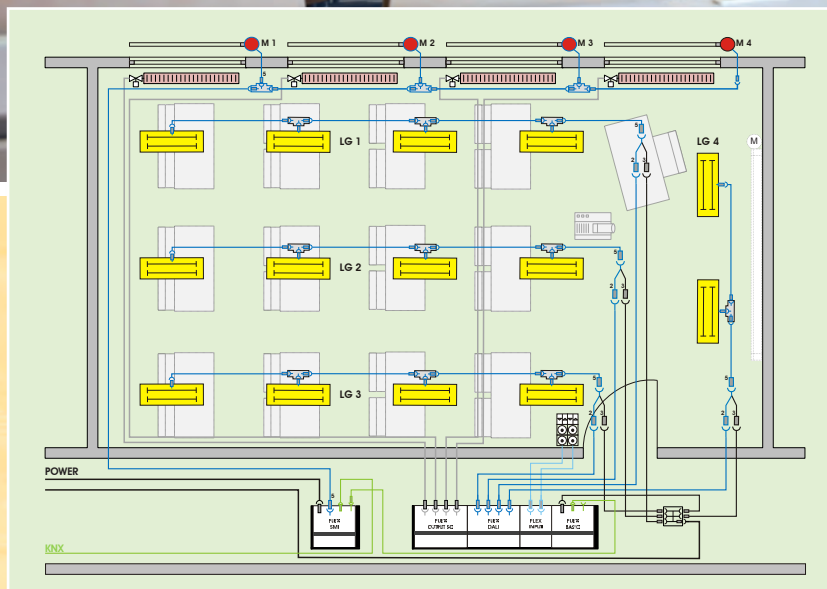

Klasseværelser

- DALI lysstyring
- Ny SMI for solafskærmningsstyring
- Transistor udgang for HVAC
- Integration af konventionelle kontakter



Hospitals- og plejesektoren

Applikation

Kompakt, modulær og stikbar installation og rumautomation for:

- Sygestuer
- Administrative kontorer
- Undersøgelser værelser/ambulatorier
- Kantiner og køkkener
- Pauserum

Løsning

- Decentral, modulær rumautomation med **gesis®FLEX**
- Mekanisk og farvekodet stiksystemer
- Færdigkonfektioneret installation
- Temperaturstyring afhængig af belægningen
- Kontrol af solafskærmning

Fordele

- Sikker, enkel og klar installation
- Høj tilgængelighed til rumautomation
- Standardiseret installation af sygestuer
- Enkel renovering p.g.a. decentral rumautomation
- Automation kan let gennemføres



Sygestuer

- Lysstyring
- Ventilationskontrol (for vådområder)
- Solafskærmning med lokal sikring
- Integration af konventionelle kontakter

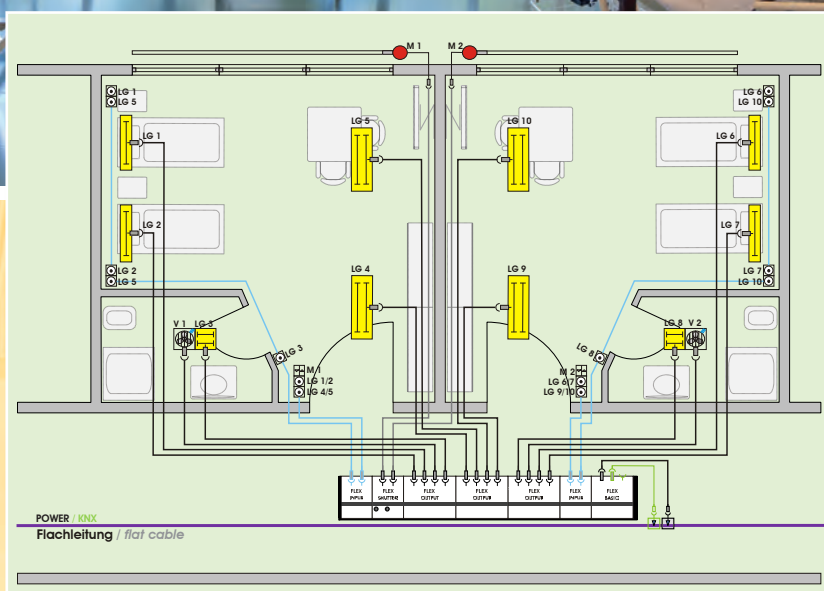



Hoteller

Applikation

Kompakt, modulær og stikbar installation og rumautomation for:

- Hotelværelser
- Køkkener og restauranter
- Administrations områder
- Konferencerum
- Event områder
- Foyerer

Løsning

- Decentral, modulær rumautomation med **gesis® FLEX**
- Færdigkonfektioneret installation
- Praktisk styring af belysning m.m.
- Styring af temperatur efter behov
- Batterifri, trådløs teknologi med EnOcean

Fordele

- Effektiv rumautomation giver en behagelig atmosfære
- Effektiv installation takket være at værelserne kan standardiseres
- Enkel implementering af nye tendenser som følge af den værelses baseret løsning
- Renovering af rum efter rum uden indflydelse på andre rum.
- Pålidelig monitoring af vinduer med trådløs teknologi

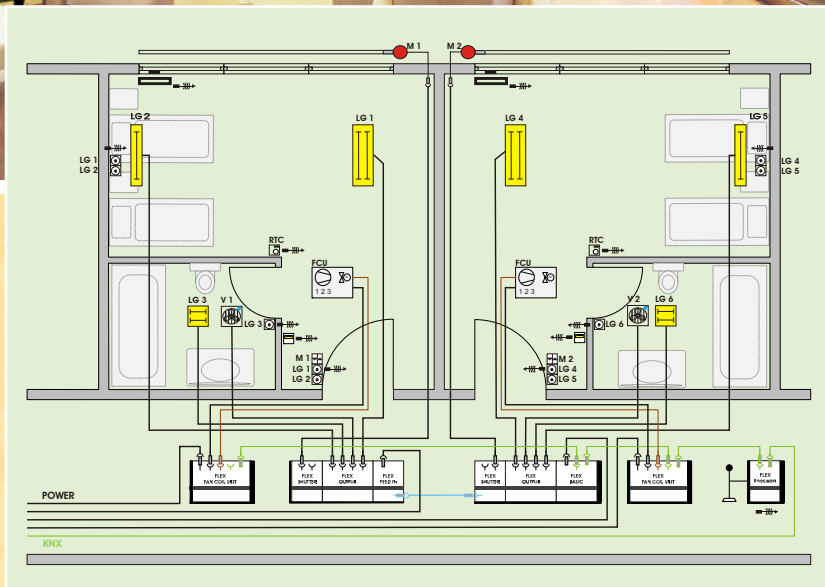

Hoteller

- Lysstyring
- Ventilationskontrol (for vådområder)
- Styring af solafskærmning med lokal sikring
- **Ny HVAC kontrol**
- Integration af alle kontakter, sensorer og kontrolenheder via EnOcean gateway



gesis® FLEX Produktprogram

Modulær – Kompakt – Stikbar

Muligheder:

- **Uden stik**, varenumre ender på **.0**
- **Med stik**, varenumre ender på **.1**

gesis® FLEX Modulær

Et basis modul kan styre op til 6 udvidelsesmoduler, der kan kombineres frit.



KNX basis og forsyningsmodul
230/400 VAC / 16 A

1-faset

gesis KNX FLEX-BAS SP	83.020.0601.0
gesis KNX FLEX-BAS SP Z	83.020.0601.1

3-faset

gesis KNX FLEX-BAS	83.020.0600.0
gesis KNX FLEX-BAS Z	83.020.0600.1



Forsyningsmodul 230/400 VAC / 16 A

1-faset

gesis FLEX-MS SP	83.020.0611.0
gesis FLEX-MS SP Z	83.020.0611.1

3-faset

gesis FLEX-MS	83.020.0610.0
gesis FLEX-MS Z	83.020.0610.1



8 binære input modul,
12 VDC

gesis FLEX-8/0	83.020.0622.0
gesis FLEX-8/0 Z	83.020.0622.1



Tænd-sluk udvidelsesmodul
230 VAC / 16 A

4 udgange

gesis FLEX-0/4	83.020.0623.0
gesis FLEX-0/4 Z	83.020.0623.1

4 udgange for kapacitiv belastning

gesis FLEX-0/4P	83.020.0626.0
gesis FLEX-0/4P Z	83.020.0626.1

3 udgange for nødbelysning

gesis FLEX-0/3 EL	83.020.0636.0
gesis FLEX-0/3 EL Z	83.020.0636.1



DALI output udvidelsesmodul
4 x16 udgange

gesis FLEX-0/4DA	83.020.0630.0
gesis FLEX-0/4DA Z	83.020.0630.1



Y-kaber for DALI application

PVC Kabel 0,5m	99.404.9999.8
halogenfrit kabel 0,5m	99.405.9999.8



Udvidelsesmodul for 2 markise udgange,
230 VAC / 8 A

gesis FLEX-0/2W	83.020.0624.0
gesis FLEX-0/2W Z	83.020.0624.1

hver udgang er forsikret med 3,15 AT sikring

gesis FLEX-0/2W F	83.020.0634.0
gesis FLEX-0/2W F Z	83.020.0634.1



Udvidelsesmodul for 2 markise udgange,
24 VDC / 3 A

gesis FLEX-0/2W DC	83.020.0627.0
gesis FLEX-0/2W DC Z	83.020.0627.1

forsikret med 6,3 AT sikring

gesis FLEX-0/2W DC F	83.020.0637.0
gesis FLEX-0/2W DC F Z	83.020.0637.1



Udvidelsesmodul for 4 transistor udgange,
230 VAC / 0,5 A

gesis FLEX-0/4HL AC	83.020.0631.0
gesis FLEX-0/4HL AC Z	83.020.0631.1

hvert output er sikret med 0,5 AT sikringer

gesis FLEX-0/4HL AC F	83.020.0632.0
gesis FLEX-0/4HL AC F Z	83.020.0632.1



4 transistor outputs udvidelsesmodul,
230 VAC / 0,5 A, med elektronisk kortslutnings og overbelastnings beskyttelse

gesis FLEX-0/4HL DC	83.020.0633.0
gesis FLEX-0/4HL DC Z	83.020.0633.1



Information om disse produkter:

0700.1 **gesis®** ELECTRONIC catalog

Du kan finde yderligere teknisk information og detaljer i vores online e-catalog på:

<https://eshop.wieland-electric.com>

gesis® FLEX Stand-alone moduler



EnOcean Gateway		
gesis KNX FLEX-ENO32		83.020.0628.0
gesis KNX FLEX-ENO32 Z		83.020.0628.1



gesis® FLEX HVAC moduler		
gesis® FLEX HVAC grundmodul		
gesis KNX FLEX-FC		83.020.0638.0
gesis KNX FLEX-FC Z		83.020.0638.1
gesis® FLEX HVAC udvidelsesmodul		
gesis FLEX-FC EM		83.020.0639.0
gesis FLEX-FC EM Z		83.020.0639.1



SMI gateway for markisestyring		
gesis KNX FLEX-SMI8		83.020.0635.0
gesis KNX FLEX-SMI8 Z		83.020.0635.1



KNX actuators i gesis® FLEX DIN-skinne system hus		
DALI gateway		G0.000.0666.8
2 tænd-sluk/dæmp aktuatorer		G0.000.0666.7
4 analoge input		G0.000.0667.0



Yderligere funktioner i gesis® FLEX DIN-skinne hus		
Strømforsyninger		
Strømforsyning 24VDC/2.5A		G0.000.0667.2
Automat sikring		
RCD/MCB 1P+N 6kA B		G0.000.0667.3
16A 30mA		

gesis® FLEX Add-on

Tomme system kompatible DIN-skinne huse for komponenter og forsyningsmoduler



Tomme DIN-skinne huse 4 moduler		
uden forskruninger		
gesis FLEX-REG4		83.020.0660.0
med forskruninger for kabel Ø=		
1 x 5-9 mm; 2 x 7-13 mm		
gesis FLEX-REG4 V		83.020.0661.0



Tomme DIN-skinne huse 4 moduler med hængslet låg uden forskruninger		
gesis FLEX-REG4 D		83.020.0662.0
med forskruninger for kabel Ø=		
1 x 5-9 mm; 2 x 7-13 mm		
gesis FLEX-REG4 DV		83.020.0663.0

gesis® FLEX Accessories



Strømforsyning 24VDC/30W		
gesis FLEX-PS 24/30		83.020.0640.0
gesis FLEX-PS 24/30 Z		83.020.0640.1



Systemudvidelse		
Forsyning		
Forlænger-kabel: 0,5m		91.257.0500.2
Forlænger-kabel: 1,0m		91.257.1000.2
Intern Bus:		
Forlænger-kabel: 0,5m		99.401.9999.8
Forlænger-kabel: 1,0m		99.401.9999.8

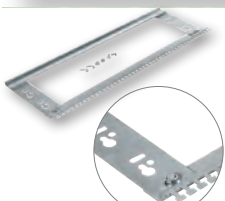

Montage ramme		
40 cm		Z5.524.1410.0
50 cm		Z5.524.1510.0
60 cm		Z5.524.1610.0
70 cm		Z5.524.1710.0
80 cm		Z5.524.1810.0
90 cm		Z5.524.1910.0
100 cm		Z5.524.2010.0



Endekappe som sæt		
		99.061.9999.9





USA
Wieland Electric Inc.
Hovedkvarter Nordamerika
2889 Brighton Road
Oakville, Ontario L6H 6C9
Telefon +1 905 8298414
Fax +1 905 829 413
www.wielandinc.com



Canada
Wieland Electric Inc.
Hovedkvarter Nordamerika
2889 Brighton Road
Oakville, Ontario L6H 6C9
Telefon +1 905 8298414
Fax +1 905 829 413
www.wieland-electric.ca



England
Wieland Electric Ltd.
Riverside Business Center,
Walnut Tree Close
GB Guildford/Surrey GU1 4UG
Telefon +44 1483 531213
Fax +44 1483 505029
sales.uk@wieland-electric.com
www.wieland-electric.co.uk



Frankrig
Wieland Electric SARL.
Le Cérame, Hall 6
47, avenue des Genottes
CS 48313,
95803 Cergy-Pontoise Cedex
Telefon +33 1 30320707
Fax +33 1 30320717
info.france@wieland-electric.com
www.wieland-electric.fr



Spanien
Wieland Electric S.L.
C/ Maria Auxiliadora 2, bajos
E-08017 Barcelona
Telefon +34 93 2523820
Fax +34 93 2523825
ventas@wieland-electric.com
www.wieland-electric.es



Italien
Wieland Electric S.r.l.
Via Edison, 209
I-20019 Settimo Milanese
Telefon +39 02 48 916357
Fax +39 02 48 920685
info.italy@wieland-electric.com
www.wieland-electric.it



Belgien & Luxemburg
ATEM-Wieland Electric NV
Bedrijvenpark De Veert 4
B-2830 Willebroek
Telefon +32 3 8661800
Fax +32 3 8661828
info.belgium@wieland-electric.com
www.wieland-electric.be



Danmark
Wieland Electric A/S
Vallørækken 26
DK-4600 Køge
Telefon +45 70 266635
Fax +45 70 266637
sales.denmark@wieland-electric.dk
www.wieland-electric.dk



Schweiz
Wieland Electric AG
Harzachstrasse 2b
CH-8404 Winterthur
Telefon +41 52 2352100
Fax +41 52 2352119
info.swiss@wieland-electric.com
www.wieland-electric.ch



Polen
Wieland Electric Sp. z o.o.
Św. Antoniego 8
62-080 Swadzim
Telefon +48 61 2225400
Fax +48 61 8407166
office@wieland-electric.pl
www.wieland-electric.pl



Kina
Wieland Electric Trading
Unit 2703 International Soho City
889 Renmin Road,
Huang Pu District
PRC-Shanghai 200010
Telefon +86 21 63555833
Fax +86 21 63550090
info-shanghai@wieland-electric.com
www.wieland-electric.cn



Japan
Wieland Electric Co, Ltd.
Nisso No. 16 Bldg. 7F
3-8-8 Shin-Yokohama,
Kohoku-ku
Yokohama 222-0033
Telefon +81 45 473 5085
Fax +81 45 470 5408
info-japan@wieland-electric.com



Tyskland
Hovedkvarter
Wieland Electric GmbH
Brennerstraße 10 – 14
96052 Bamberg, Germany
Telefon +49 951 9324-0
Fax +49 951 9324-198
info@wieland-electric.com
www.wieland-electric.de

Salgs partnere: Du kan finde vores salgspartnere worldwide i mere end 70 lande.
Find din kontakt på: www.wieland-electric.com

Der tages forbehold for ændringer! **gesis[®], RST[®], GST[®], GST18[®], podis[®], samos[®] and saris[®]** er alle registreret varemærker tilhørende Wieland Electric GmbH

**contacts
are
green.**