

Special-Sensors for Automation

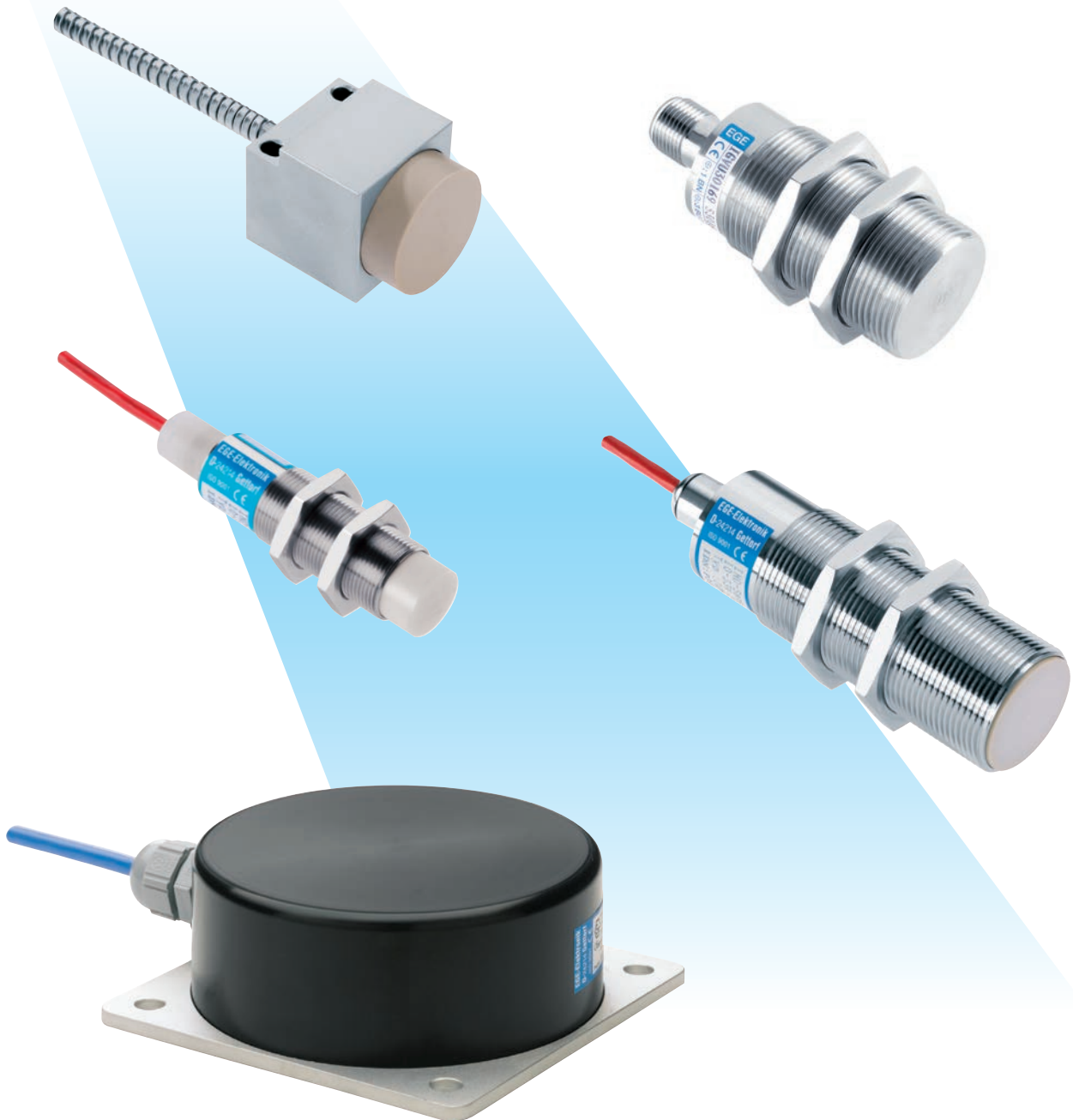

Inductive Sensors

Contents

Terminology for inductive measurement	3.03 - 3.05
Application notes	3.06
Extreme environment	
Metal face sensors Series IGV / IGUV...-C / IGWV.....	3.07 - 3.10
Mounting clamp for metal face sensors Series KBM	3.11
POLAR-Series climatic-proofed -60 °C Series IGMP.....	3.12 - 3.13
POLAR-Series climatic-proofed -80 °C Series IGMP.....	3.14
TROPICAL-Series climatic proofed 120 °C Series IGMF / IGMW	3.15 - 3.20
TROPICAL-Series resistant to cooling fluids 120 °C Series IGFW / INFW.....	3.21
TROPICAL-Series resistant to cooling fluids armoured cable Series IGMF / INFW	3.22 - 3.23
High temperature 120 °C Series IGMT.....	3.24 - 3.25
High temperature 120 °C Series IDT	3.26
High temperature 160 °C Series IGMH	3.27 - 3.28
High temperature 250 °C Series IGH / IRH / IDH	3.29 - 3.30
High temperature 200 °C Series INT	3.31
Amplifiers for high temperature sensors Series IKM / IU	3.32 - 3.33
Demanding environment	
Metal sleeve M12 / M18 / M30 Series IGM	3.34 - 3.37
Long sensing range Ø 80 mm / Ø 105 mm / Ø 160 mm / Ø 200 mm Series ID	3.38 - 3.41
Analog sensors	
Metal sleeve M12 / M18 / Series IGA.....	3.42 - 3.43
Long sensing range Ø 80 mm Series IDA	3.43
High temperature 160 °C Series IGT.....	3.44
Standard switches	
Metal sleeve M12 / M18 / M30 Series IGM	3.45 - 3.46
Smooth-bodied switches Ø 20 mm / Ø 34 mm Series INK	3.47
Special functions	
Surface sensors Series IFE.....	3.48 - 3.49
Offshore Series IGMO	3.50
Washing resistant Series IDKW.....	3.51
Factor 1 Series IGB / IDB	3.52
Ex-Series	
Ex-Zone 20, compact model Series IGEX20	3.53
Ex-Zone 0/20, intrinsically safe Series IGEX	3.54 - 3.55
Ex-Zone 22, compact model Series IGEX / IGVEX	3.56 - 3.58
Ex-Zone 20, compact model Series IDEX20	3.59
Ex-Zone 0/20, intrinsically safe Series IDEX	3.60
Ex-Zone 22, compact model Series IDEX	3.61
Ex-amplifiers Series EGE 90 Ex / EGE 903 Ex / IKM 122 Ex.....	3.62 - 3.64
Accessories	
M12 connector	3.65
PG plug system	3.66
Assembly parts.....	3.67

Technical alterations are reserved to us without prior announcement. The information provided in this catalogue is for reference only. Product installation information can be found in the instructions supplied with each product.

Terminology for inductive measurement

Operating Principal

An inductive proximity switch works with a high frequency oscillating circuit that creates an alternating electromagnetic field on the active sensor surface by means of a coil. When a metallic object nears this field a damping occurs in the oscillating circuit. If this damping exceeds a threshold value, a switching signal is generated.

Operating distance

The operating distance is the distance between an object and the active sensor surface at which a switching signal is generated. The operating distance depends on the diameter of the coil. Therefore larger sensors are required for longer operating distances. On some of the EGE sensors the operating distance is adjustable.

If a metal object dampens only a part of the alternating field, the operating distance decreases; a larger object increases it. The following approximate values are derived from a standard rectangular measurement plate made of steel ST 37 with an edge length that corresponds to the diameter of the sensor coil or three times the rated operating distance, whichever is greater.

Damping area in %						
150	100	75	50	25	12.5	
Operating distance in %						
110	100	93	86	73	55	

The operating distance is influenced by the material of the object: Constant dimensions for different materials against steel ST 37 yield a changed operating distance.

The following table lists approximate values for the material dependent reduction factors. In practical applications variations could occur due to different alloying, for example.

Material	Operating distance in %
steel ST37	100
stainless steel	70
brass (Br)	50
copper (Cu)	45
aluminium (Al)	40

Rated operating distance s_n

The rated operating distance is a device parameter that does not take into account sample variances and external influences such as temperature and supply voltages.

Effective operating distance s_r

The effective operating distance is the operating distance at nominal voltage and a nominal temperature of 23 °C. It is between 90% and 110% of the rated operating distance.

Usable operating distance s_u

The usable operating distance lies in the entire allowable temperature and voltage range between 90% and 110% of the effective operating distance.

Assured operating distance s_a

The assured operating distance takes into account all the external influences and sample variances and lies in the range from 0% to 80% of the usable operating distance. Within this range a guaranteed switching is ensured.

Switch point drift

The operating distances are given for an ambient temperature of 23 °C. In the permissible temperature range the operating distance varies by less than 15% from the value at 23 °C. The temperature of the measured object has no influence on the switch point.

Hysteresis H

The switching hysteresis describes the distance between the turn-on point while approaching an object and the turn-off point during the separation of it from the sensor. The hysteresis brings about a stable switching signal even when there are vibrations, temperature drift, or electrical variations. The hysteresis is defined in EN 60947-5-2 as a maximum 20% from the effective operating distance, and carries a value of typically 10% from the effective operating distance s_r for EGE sensors.

Repeating accuracy R

The repeating accuracy describes the maintenance of the switching point after the repeated approach of an object under specified circumstances. EGE sensors have typical tolerances of less than 3% of the effective operating distance.

Switching frequency

The maximum switching frequency of the sensor is determined at half rated operating distance s_n with standard measurement plates to EN 60947-5-2

Terminology for inductive measurement

Operating voltage

The operating voltage is the voltage range within EGE sensors function safely. For a constant voltage supply it is important to make sure that the limits are still observed when the residual ripple is included.

Switching current

This current gives the maximum long-term current for the switching output of the sensor at an ambient temperature of 25 °C and ohmic load. At an elevated ambient temperature, the current load capability decreases.

For analog outputs, the boundary values given in the appropriate technical data, and particularly the permissible values for resistance loads, must be observed.

Short circuit protection

The short circuit protection ensures the sensor against destruction through a short circuit on the output. After removal of the fault, the output is reactivated. Where a maximum overload current is listed, this should not be exceeded.

Excess-current release

This value indicates the median value of current at which the short circuit protection responds with a tolerance of $\pm 20\%$.

Reverse polarity protection

The reverse polarity protection prevents destruction of the sensor by a reversal of the polarity of the voltage supply.

Voltage drop U_d

The voltage drop arises at the internal resistance of semiconductor elements, which are in the current-path of the output. It is dependent of the load-current and is declared according to EN 60947-5-2 for a mean current of 50 mA.

Residual current I_r

The residual current flows in the load current circuit when the output is blocked. The residual current must be considered when switching sensors in parallel.

Minimum load current I_m

The minimum load current is necessary for flawless operation with two-wire devices.

Current consumption

The current consumption is the maximum value of the no-load current I_0 that the sensor can absorb without a load.

Ambient temperature

The ambient temperature indicates the maximum allowable temperature range for the sensor.

Electromagnetic compatibility EMC

The EMC class is a measure of the noise immunity of the sensor against external electrical and magnetic influences. The information is based on the standard EN 61000-6-2.

Switch-on impulse suppression

EGE sensors have a switch-on suppression that blocks the output during the switch-on phase, when the operational voltage is applied.

Protective system

The protective system indicates the protection of the sensors against penetration of foreign bodies and water to EN 60529.

LED display

EGE sensors with yellow light-emitting diodes indicate the switching status optically.

Housing material

The housing material determines the chemical resistance of the sensor against external influences. For special applications, other housing materials are available.

Connection

The connection of the sensors is accomplished through plug-in connections or cables. Different cable types and lengths are available upon request.

Instructions for mounting

Mounting

For flush mounting the sensor can be built into metal up to its active surface without changing its characteristics. For non-flush mounting a metal-free zone around the sensor must be allowed for. A free zone to the material opposite the sensor must be maintained for all sensors.

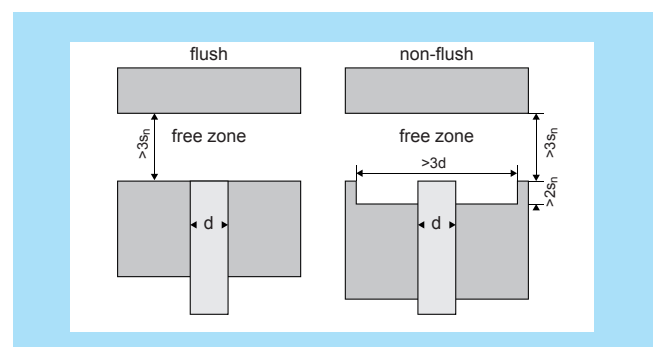

The indicated free zones are in accordance with the standard EN 60947-5-2.

Fixing nuts are part of delivery for all metal thread sensors. For mounting clamps see page 3.67.

Terminology for inductive measurement

Collocation

When collocating the sensors, a minimum separation must be kept between the devices. When in doubt, a test should be conducted under application conditions. For flush mounting the lateral separation between two sensors must correspond to at least the diameter of the sensor. For non flush mounting, the lateral separation from each other must correspond to at least twice the diameter of the sensor. For oppositely mounted sensors, a minimal separation of six times the rated operating distance should be allowed.

Torques

In order to prevent destruction of the threaded bushing during fitting, the following maximum torques must not be exceeded:

Design	Metal Housing	Plastic Housing
M12x1	10 Nm	1 Nm
M18x1	25 Nm	2 Nm
M30x1.5	40 Nm	5 Nm

PTFE sensors may only be tightened by hand.

Instructions for operation

Serial connection

For the serial connection of two wire or three wire sensors the individual voltage drops are added together. Therefore there is a lesser operational voltage at the disposal of the load. The addition of the switch-on delay times should be noted.

Parallel connection

The parallel connection of two wire sensors can only be conditionally recommended since the residual currents are added together and flow through the load. For the parallel connection of three wire sensors, the current consumption of the individual devices is added together. Since this current does not flow through the load, the maximum number of parallel connectable three wire sensors depends only on the power supply.

Approval for safety applications

Sensors for personal security must have a qualification approval according to EN 954-1 and must be labeled accordingly. Sensors that are not labeled must not be used for applications of this kind.

Valid standards:

- EN 60947-5-2
Control units; low voltage control units, auxiliary switch, proximity switch
- EN 61000-6-4
Electromagnetic compatibility (EMC)
Interference emissions in the industrial area
- EN 61000-6-2
Electromagnetic compatibility (EMC)
Generic standards immunity for industrial environments
- EN 61000-4-2 (ESD)
Electrostatic discharging immunity
- EN 61000-4-3 (HF radiated)
Radiated radio-frequency electromagnetic field immunity test
- EN 61000-4-4 (Burst)
Electrical fast transient/burst immunity test
- EN 61000-4-5 (Surge)
Surge immunity test
- EN 60529
Protective systems, IP-designation
- EN 60079-0 : 2009
Explosive atmospheres –
Part 0: Equipment – General requirements
- EN 60079-11 : 2007
Explosive atmospheres –
Part 11: Equipment protection by intrinsic safety "i"
- EN 60079-18 : 2009
Explosive atmospheres –
Part 18: Equipment protection by encapsulation "m"
- EN 61241-11 : 2006
Electrical apparatus for use in the presence of combustible dust – Part 11: Protection by intrinsic safety "iD"

Authorisations

TÜV NORD CERT Zertifizierungsstelle - Deutschland
(technical monitoring certification agency - Germany)

Certification

- TÜV NORD CERT ISO 9001
- TÜV NORD CERT Quality control production
Attachment IV of the EC-Guidelines
94/9/EG
- TÜV Nord Re-cancelling certificate according to
EN 10204

Application notes

Metal face sensors page 3.07 - 3.10

The inductive proximity switches series IGV are used in areas with heavy-duty mechanical loads at the sensor's face or where seals between face and housing cannot be used. Chips hitting the front or frequently changing coolants or lubricants do not diminish the function of these proximity switches. The variants with a PTFE coating are particularly well-suited for welding lines and similar environments where sensors are exposed to heavy soiling. Metal face switches are manufactured from stainless steel and are one solid piece. They detect iron and steel through the metal front face.

POLAR-Switches page 3.12 - 3.14

The POLAR-switch is ideal for application in cold storage houses and in extreme climate conditions. It is waterproof, safe for cleaning and extremely chemical-resistant. Because of its stainless steel housing, it can withstand vibrations on vehicles. The POLAR-switch is very compact and robust, it can be used from $-60\text{ }^{\circ}\text{C}$ to $+60\text{ }^{\circ}\text{C}$. IGMF 030 S-80 sensors are suitable in cryogenic processes and for medical-technical applications; they can be used for temperatures up to $-80\text{ }^{\circ}\text{C}$.

TROPICAL-Switches page 3.15 - 3.20

The TROPICAL switches series IGMF are anticipated for applications in corrosive environment. They are stable particularly at frequent temperature changes and simultaneously high humidity. The permanent work in carwashes is permissible. The high corrosion resisting at simultaneously high mechanical loading capacity is reached through the combination of PTFE and titan stabilized stainless steel. The PTFE-hoods are sealed through fluoroelastomers O-rings surely. The FEP-connecting cable is poured within the housing and freed over a double seal from the housing. Cable lengths up to 100 m are available. The installed LED's are shining through the cable side cap and don't break out the case. IGMW series sensors are suitable for hydro steam environments with pressures of up to 4 bars. For higher pressures in hydro steam environments, IGWW series sensors made of full stainless steel are recommended.

120 °C-High temperature switches page 3.21 - 3.26

The inductive PTFE switches series IGFW and INFW are made entirely of PTFE. The housing cover is securely sealed with a fluoroelastomer O-Ring. These sensors are designed for particularly difficult and aggressive environmental conditions. They can be used in damp and aggressive environments as well as under water (oil). IGMT- and IDT-series proximity switches are designed for use in temperatures up to $120\text{ }^{\circ}\text{C}$.

160 °C-High temperature switches page 3.27 - 3.28

Inductive compact devices for ambient temperatures up to $160\text{ }^{\circ}\text{C}$ are available flush and non-flush in the standard designs M12, M18 and M30 with switching distances from

2 mm to 15 mm. The material used is the rugged stainless steel housing combined with high temperature resistant PEEK plastic.

250 °C-High temperatures sensors page 3.29 - 3.30

The inductive proximity switches series IGH/IDH/IRH are used for ambient temperatures up to $250\text{ }^{\circ}\text{C}$. The units feature optional a plug connection which withstands high temperatures, allowing users to quickly and easily install a replacement sensor head in case of damage without having to replace the sensor cable. The sensors are particularly suited for operation in extreme heat, e. g. in drying ovens or brick kilns. Manufactured from aluminum / stainless steel and PEEK, the robust sensors can be used in rugged industrial environments. Their electronics are housed separately in a pluggable cable amplifier. The units are connected via a metal armored cable.

Amplifiers page 3.32 - 3.33

Switching amplifiers are designed for induction sensors for which it is necessary to separate the sensor coil from the amplifier, e. g. for operating temperatures above $160\text{ }^{\circ}\text{C}$ or for sensor coils which must be exchanged due to frequent damage.

The switching amplifiers work statically, that is, if the sensor coil is permanently damped, the switching output also remains activated. Switching interval and hysteresis (IKM 120 GPP, IU 130...) can be set on the amplifier. The sensor cable may have a length of up to 20 m.

Demanding environment Seite 3.34 - 3.41

The "Demanding environment" series is especially designed for harsh environments in which sensors are subjected to high electrical, electromagnetic or mechanical stress. For sensors used in critical applications, EGE has developed special inspection and test methods which place particular emphasis on the disturbances that occur in various production environments. The sensors are designed to be very resistant to the interference spectra produced by, e. g., frequency inverters, wireless communication systems and switching power supplies.

Surface sensors IFE... page 3.48 - 3.49

The switches are build as flat sensors. They are used particularly to detect moving sheet metal or steel rods on conveyor belts. The complete sensor is covered, which make the sensor moisture resistant.

Reduced overall height affects the operating distance (sn). The IFE switches are self-contained with integral amplifier.

Dust- and Gas-Ex sensors page 3.53 - 3.61

IGEX and IDEX are sensors for detecting metals in the Ex area zone 0/20 and zone 22 according to ATEX. Devices can be delivered in the standard configurations M12, M18 and M30. For large switching distances there are configurations with diameters of 80 mm to 160 mm.

Metal face sensors • Plug connection

Series IGUV - Proximity switches

M12 / M18 / M30

One piece stainless steel housing

DC 10...30 V

Shock resistant
Impact proof



Design	DC PNP M12 • M18 • M30			DC 2-Wire M12 • M18 • M30					
Dimensions									
Operating distance sn [mm]	2	5	10	2	5	10			
Switching output PNP									
ID-No.	P31193	P31194	P31195	P31225	P31226	P31227			
Type	IGVU 02 GSP	IGVU 05 GSP	IGVU 10 GSP	IGVU 02 GS	IGVU 05 GS	IGVU 10 GS			
Supply voltage [V]	10...30 DC			8...30 DC					
Switching current [mA]	250			150					
Short circuit proof	•			•					
Reverse protection	•			•					
Voltage drop max. [V]	1.5			3.5					
Current consumption [mA]	5			1.5					
Switching frequency [Hz]	180	180	150	180	180	150			
Ambient temperature [°C]	-25...+80			-25...+80					
EMC-class	A			A					
Protection [EN 60529]	IP 68 + IP 69K			IP 68 + IP 69K					
LED display	•			•					
Housing material	AISI 316 L			AISI 316 L					
Connection	M12 connector			M12 connector					
The specified operating distance (sn) applies to ferromagnetic objects (ST37).									
Accessories	connecting cable type SLG 3-2 (Z01076), page 3.65								

Metal face sensors • Cable connection





Series IGV - Proximity switches

M12 / M18 / M30
One piece stainless steel housing

DC 10...30 V

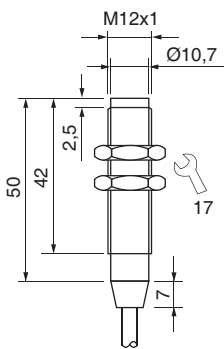
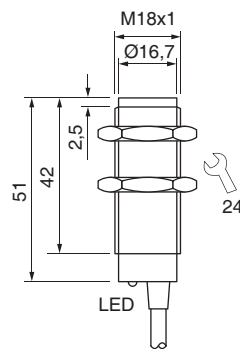
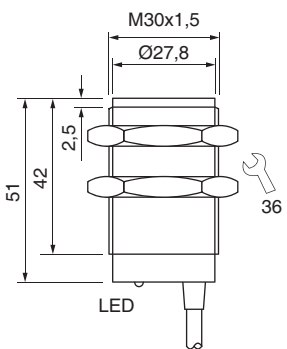
Shock resistant
Impact proof

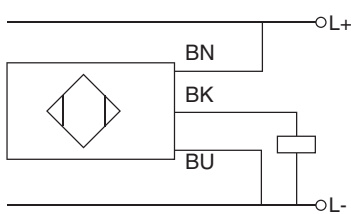

Design	DC PNP • M12x1	DC PNP • M18x1	DC PNP • M30x1.5
Dimensions			
Operating distance sn [mm]	2	5	10
Switching output PNP			
ID-No.	P31228	P31229	P31230
Type	IGV 02 GSP	IGV 05 GSP	IGV 10 GSP
Supply voltage [V]	10...30 DC		
Switching current [mA]	250		
Short circuit proof	•		
Reverse protection	•		
Voltage drop max. [V]	1.5		
Current consumption [mA]	max. 5		
Switching frequency [Hz]	180	180	150
Ambient temperature [°C]	-25...+80		
EMC-class	A		
Protection [EN 60529]	IP 67		
LED display	•		
Housing material	AISI 316 L		
Connection	2 m PVC-cable 3x0.34 mm ²		
The specified operating distance (sn) applies to ferromagnetic objects (ST37).			

Metal face sensors • PTFE-coated

Series IGUVU - Proximity switches





M12 / M18 / M30

One piece stainless steel housing

DC 10...30 V

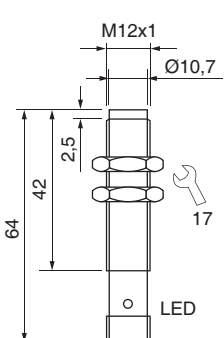
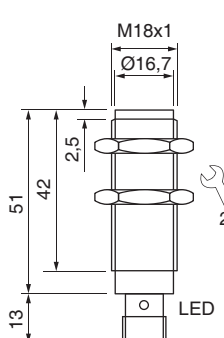
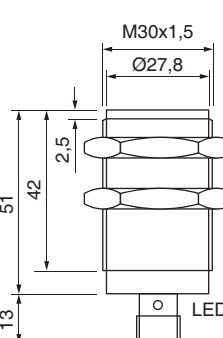
Shock resistant
Impact proof

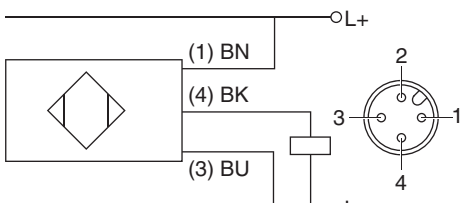

Design	DC PNP • M12x1	DC PNP • M18x1	DC PNP • M30x1.5
Dimensions			
Operating distance sn [mm]	2	5	10
Switching output PNP			
ID-No.	P31234	P31235	P31236
Type	IGVU 02 GSP-C	IGVU 05 GSP-C	IGVU 10 GSP-C
Supply voltage [V]	10...30 DC		
Switching current [mA]	250		
Short circuit proof	•		
Reverse protection	•		
Voltage drop max. [V]	1.5		
Current consumption [mA]	5		
Switching frequency [Hz]	180	180	150
Ambient temperature [°C]	-25...+80		
EMC-class	A		
Protection [EN 60529]	IP 68 + IP 69K		
LED display	•		
Housing material	AISI 316 L, PTFE-coated		
Connection	M12 connector		
	Design with fixed cable on request		
The specified operating distance (sn) applies to ferromagnetic objects (ST37).			
Accessories	connecting cable SLG 3-2 (Z01076), page 3.65		

Metal face sensors • Climatic-proofed

Series IGWV - Proximity switches

M12 / M18 / M30
One piece stainless steel housing

DC 10...30 V

Shock resistant
Impact proof

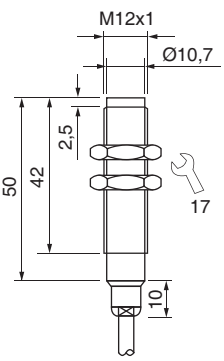
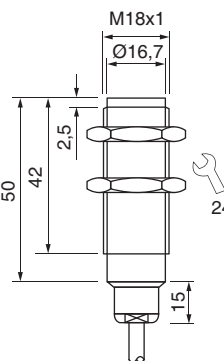
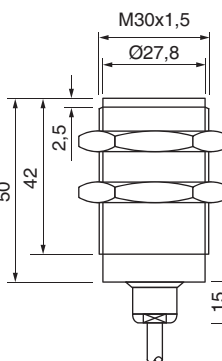
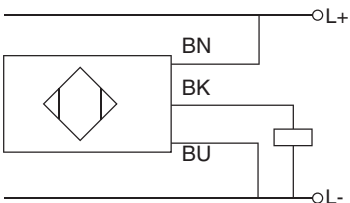

Design	DC PNP • M12x1	DC PNP • M18x1	DC PNP • M30x1.5
Dimensions			
Operating distance sn [mm] Switching output PNP	2	5	10
ID-No.	P31237	P31238	P31239
Type	IGWV 02 GSP	IGWV 05 GSP	IGWV 10 GSP
Supply voltage [V]	10...30 DC		
Switching current [mA]	250		
Short circuit proof	•		
Reverse protection	•		
Voltage drop max. [V]	1.5		
Current consumption [mA]	5		
Switching frequency [Hz]	180	180	150
Ambient temperature [°C]	-10...+110		
EMC-class	A		
Protection [EN 60529]	IP 68 + IP 69K		
Housing material	AISI 316 Ti		
Connection	2 m FEP-cable 3x0.34 mm ²		
The specified operating distance (sn) applies to ferromagnetic objects (ST37).			

Mounting clamp • For metal face sensors

Series KBM 012 / KBM 018 / KBM 030

Impact- and shock resistant,
protected installation

Simple adjustment
via slotted holes

Mount and replace sensor
quickly and precisely



Design KBM 012 • KBM 018 • KBM 030

Dimensions

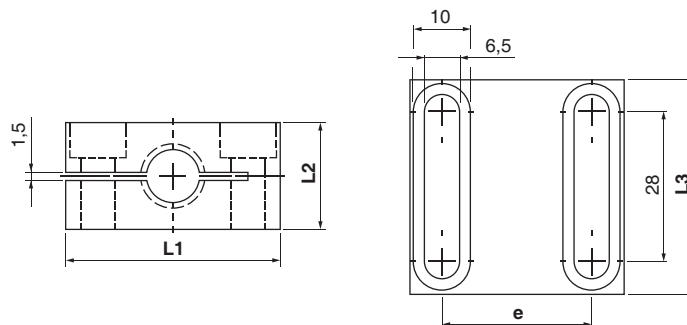

ID-No.	Z01209	Z01210	Z01211	Z01212	Z01213	Z01214
Type	KBM 012 A-ST52	KBM 018 A-ST52	KBM 030 A-ST52	KBM 012 B-A2	KBM 018 B-A2	KBM 030 B-A2
For sensor design	M12	M18	M30	M12	M18	M30
Dimensions						
L1 x L2 x L3 [mm]	34 x 24 x 40	40 x 30 x 40	55 x 40 x 40	34 x 24 x 40	40 x 30 x 40	55 x 40 x 40
Hole spacing e [mm]	20	26	40	20	26	40
Sensor installation	flushed relative to the set back surface			set back		
Housing material	ST52, hardened			AISI 303		

Note:
Mounting clamps are fastened to their metal surface using M6 hexagon socket screws. Make sure that the provided stainless steel washers have been placed in-between.

The typical torque is 6 Nm.

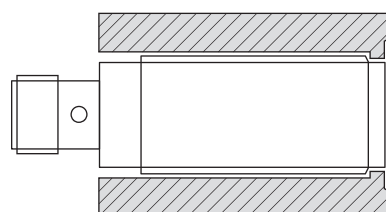

flushed relative to the set back surface

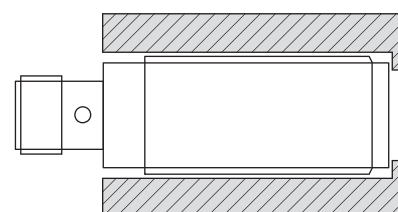

set back

POLAR-Series DC • Climatic-proofed –60 °C

Series IGMP - Proximity switches

M12 / M18 / M30

Stainless steel sleeve

DC 10...30 V

IP 68 Water-proofed

IP 69K Resistant to high pressure cleaning



Design	DC PNP • M12x1		DC PNP • M18x1		DC PNP • M30x1.5	
Dimensions						
Installation flush (f) non flush (nf)						
Operating distance sn [mm] Switching output PNP	2 f	4 nf	5 f	7 nf	10 f	15 nf
ID-No.	P31145	P31146	P31147	P31148	P31219	P31220
Type	IGMP 02 GSP	IGMP 04 GSP	IGMP 05 GSP	IGMP 08 GSP	IGMP 010 GSP	IGMP 015 GSP
Supply voltage [V]	10...30 DC					
Switching current [mA]	200					
Short circuit proof	•					
Overcurrent release [mA]	230					
Reverse protection	•					
Voltage drop max. [V]	2					
Load current [mA]	-					
Current consumption [mA]	4					
Switching frequency [Hz]	1000					
Ambient temperature [°C]	-55...+60					
Temperature min. [°C]	-60					
Temperature gradient [K/min]	5					
EMC-class	A					
Protection [EN 60529]	IP 68 + IP 69K					
LED display	•					
Housing material	PTFE / AISI 316 Ti					
Connection	2 m FEP-cable 3x0.34 mm ²					
Switching current						

POLAR-Series AC • Climatic-proofed –60 °C

Series IGMP - Proximity switches

M18

Stainless steel sleeve



AC 20...250 V

IP 68 Water-proofed

IP 69K Resistant to

high pressure cleaning

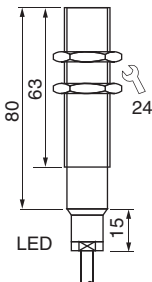
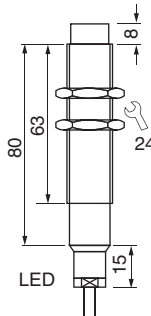

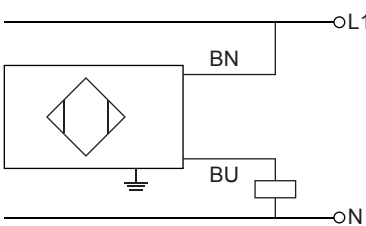
Design	AC • M18x1	
Dimensions		
Installation flush (f) non flush (nf)		
Operating distance sn [mm]	5 f	7 nf
Switching output		
ID-No.	P31149	P31150
Type	IGMP 005 WS	IGMP 008 WS
Supply voltage [V]	20...250 AC	
Switching current [mA]	300	
Short circuit proof	-	
Overcurrent release [mA]	-	
Reverse protection	-	
Voltage drop max. [V]	4.5	
Load current [mA]	5	
Current consumption [mA]	2.5	
Switching frequency [Hz]	25	
Ambient temperature [°C]	-55...+60	
Temperature min. [°C]	-60	
Temperature gradient[K/min]	5	
EMC-class	A	
Protection [EN 60529]	IP 68 + IP 69K	
LED display	•	
Housing material	PTFE / AISI 316 Ti	
Connection	2 m FEP-cable 3x0.75 mm ²	
		

POLAR-Series • Climatic-proofed –80 °C

Series IGMP - Proximity switches

M30

Stainless steel sleeve

IP 68 Water-proofed

–80 °C permanent temperature

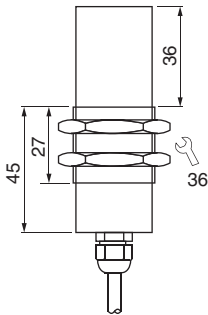
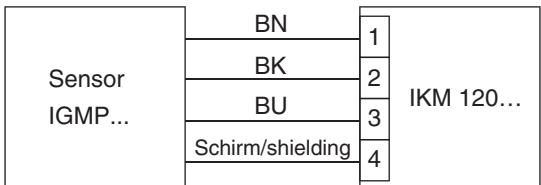

Design	M30x1.5
Dimensions	
Installation flush (f) non flush (nf)	
Operating distance sn [mm]	3 nf
ID-No.	P31337
Type	IGMP 030 S-80
Supply voltage [V]	-
Switching current [mA]	-
Hysteresis max. [%]	10
Short circuit proof	-
Reverse protection	-
Current consumption [mA]	-
Switching frequency [Hz]	-
Ambient temperature [°C]	-80...+50
EMC-class	A
Protection [EN 60529]	IP 68
LED display	-
Housing material	PTFE / AISI 316 Ti
Connection	2 m FEP-cable 3x0.75 mm ² , shielded
Sensor for the connection to amplifier IKM 120...	

TROPICAL-Series DC • Climatic-proofed 120 °C

Series IGMF - Proximity switches

M12 / M18-short form
Stainless steel sleeve

DC 10...30 V

IP 68 Water-proofed
IP 69K Resistant to
high pressure cleaning



Design	DC PNP • M12x1		DC PNP • M18x1	
Dimensions				
Installation flush (f) non flush (nf)				
Operating distance sn [mm]	2 f	4 nf	5 f	7 nf
GSP ID-No.	P31132	P31133	P30701	P30703
Type	IGMF 02 GSP	IGMF 04 GSP	IGMF 05 GSP	IGMF 08 GSP
GOP ID-No.			P30702	P30704
Type			IGMF 05 GOP	IGMF 08 GOP
Supply voltage [V]	10...30 DC			
Switching current [mA]	200			
Overcurrent release [mA]	230			
Current consumption [mA]	4			
Residual current [µA]	1			
Voltage drop approx. [V]	2			
Switching frequency [Hz]	1000			
Ambient temperature [°C]	-25...+120			
Compressive strength [bar]	10			
Residual ripple max. [%]	10			
EMC-class	A			
Protection [EN 60529]	IP 68 + IP 69K			
Housing material	PTFE / AISI 316 Ti (A4)			
Connection	2 m FEP-cable 3x0.34 mm ²			
Switching current				

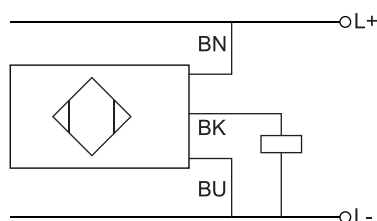
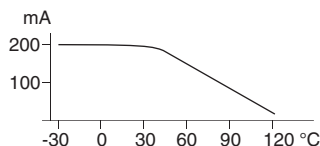

TROPICAL-Series DC • Climatic-proofed 120 °C

Series IGMF - Proximity switches

M18 / M30

Stainless steel sleeve

DC 10...55 V

IP 68 Water-proofed

IP 69K Resistant to high pressure cleaning



Design	DC PNP • M18x1		DC PNP • M30x1,5	
Dimensions				
Installation flush (f) non flush (nf)				
Operating distance sn [mm]	5 f	7 nf	10 f	15 nf
GSP ID-No.	P30705	P30708	P30711	P30714
Type	IGMF 005 GSP	IGMF 008 GSP	IGMF 010 GSP	IGMF 015 GSP
GOP ID-No.	P30706	P30709	P30712	P30715
Type	IGMF 005 GOP	IGMF 008 GOP	IGMF 010 GOP	IGMF 015 GOP
GSOP ID-No.	P30707	P30710	P30713	P30716
Type	IGMF 005 GSOP	IGMF 008 GSOP	IGMF 010 GSOP	IGMF 015 GSOP
Supply voltage [V]	...GSP, ...GOP 10...55 DC / ...GSOP 10...30 DC			
Switching current [mA]	...GSP, ...GOP 400 / ...GSOP 200			
Overcurrent release [mA]	...GSP, ...GOP 430 / ...GSOP 230			
Current consumption [mA]	4			
Residual current [µA]	1			
Voltage drop approx. [V]	2			
Switching frequency [Hz]	...GSP, ...GOP 150 / ...GSOP 1000			
Ambient temperature [°C]	-25...+120			
Compressive strenght [bar]	10			
EMC-class	A			
Protection [EN 60529]	IP 68 + IP 69K			
Housing material	PTFE / AISI 316 Ti (A4)			
Connection	2 m FEP-cable 3x0.34 mm ² / 2 m FEP-cable 4x0.25 mm ²			
Switching current				

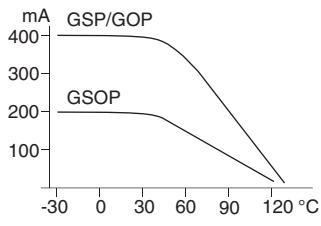

TROPICAL-Series AC • Climatic-proofed 120 °C

Series IGMF - Proximity switches

M18 / M30

Stainless steel sleeve

AC 20...250 V

IP 68 Water-proofed

IP 69K Resistant to

high pressure cleaning



Design	AC • M18x1		AC • M30x1.5	
Dimensions				
Installation flush (f) non flush (nf)				
Operating distance sn [mm]	5 f	7 nf	10 f	15 nf
WS ID-No.	P31071	P31073	P31075	P31077
Type	IGMF 005 WS	IGMF 008 WS	IGMF 010 WS	IGMF 015 WS
WO ID-No.	P31070	P31072	P31074	P31076
Type	IGMF 005 WO	IGMF 008 WO	IGMF 010 WO	IGMF 015 WO
Supply voltage WS/WO [V]	20...250 AC			
Switching current WS/WO [mA]	< 400			
Current consumption [mA]	< 2.5			
Voltage drop eff. [V]	< 5			
Switching frequency [Hz]	25			
Ambient temperature [°C]	-25...+120			
Compressive strength [bar]	10			
Minimum load current [mA]	5.0			
EMC-class	A			
Protection [EN 60529]	IP 68 + IP 69K			
Housing material	PTFE / AISI 316 Ti (A4)			
Connection	2 m FEP-cable 3x0.75 mm ²			
Switching current				

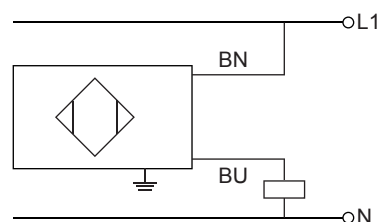
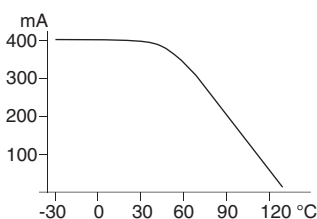

TROPICAL-Series DC • Climatic-proofed 120 °C

Series IGMW - Proximity switches

M12 / M18-short form
Stainless steel sleeve

DC 10...30 V

IP 68 Water-proofed
IP 69K Resistant to
high pressure cleaning
Steam proof



Design	DC PNP • M12x1		DC PNP • M18x1	
Dimensions				
Installation flush (f) non flush (nf)				
Operating distance sn [mm]	2 f	4 nf	5 f	7 nf
GSP ID-No. Type	P31338 IGMW 02 GSP	P31339 IGMW 04 GSP	P31340 IGMW 05 GSP	P31341 IGMW 08 GSP
GOP ID-No. Type			P31342 IGMW 05 GOP	P31343 IGMW 08 GOP
Supply voltage [V]	10...30 DC			
Switching current [mA]	200			
Overcurrent release [mA]	230			
Current consumption [mA]	4			
Residual current [µA]	1			
Voltage drop approx. [V]	2			
Switching frequency [Hz]	1000			
Ambient temperature [°C]	-25...+120			
Compressive strength [bar]	10			
Residual ripple max. [%]	10			
EMC-class	A			
Protection [EN 60529]	IP 68 + IP 69K			
Housing material	PTFE / AISI 316 Ti (A4)			
Connection	2 m FEP-cable 3x0.34 mm ²			
Switching current				

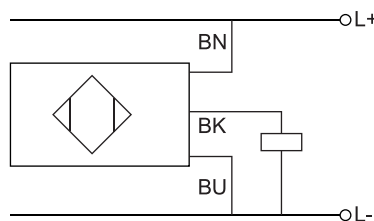
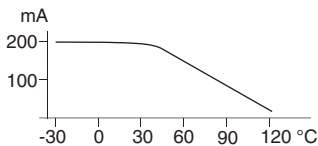

TROPICAL-Series DC • Climatic-proofed 120 °C

Series IGMW - Proximity switches

M18 / M30

Stainless steel sleeve

DC 10...55 V

IP 68 Water-proofed

IP 69K Resistant to

high pressure cleaning

Steam proof



Design	DC PNP • M18x1		DC PNP • M30x1,5	
Dimensions				
Installation flush (f) non flush (nf)				
Operating distance sn [mm]	5 f	7 nf	10 f	15 nf
GSP ID-No. P31344 Type IGMW 005 GSP				
GOP ID-No. P31348 Type IGMW 005 GOP				
GSOP ID-No. P31352 Type IGMW 005 GSOP				
Supply voltage [V]	...GSP, ...GOP 10...55 DC / ...GSOP 10...30 DC			
Switching current [mA]	...GSP, ...GOP 400 / ...GSOP 200			
Overcurrent release [mA]	...GSP, ...GOP 430 / ...GSOP 230			
Current consumption [mA]	4			
Residual current [µA]	1			
Voltage drop approx. [V]	2			
Switching frequency [Hz]	...GSP, ...GOP 150 / ...GSOP 1000			
Ambient temperature [°C]	-25...+120			
Compressive strenght [bar]	10			
EMC-class	A			
Protection [EN 60529]	IP 68 + IP 69K			
Housing material	PTFE / AISI 316 Ti (A4)			
Connection	2 m FEP-cable 3x0.34 mm ² / 2 m FEP-cable 4x0.25 mm ²			
Switching current				

TROPICAL-Series AC • Climatic-proofed 120 °C

Series IGMW - Proximity switches

M18 / M30

Stainless steel sleeve

AC 20...250 V

IP 68 Water-proofed

IP 69K Resistant to

high pressure cleaning

Steam proof



Design	AC • M18x1		AC • M30x1.5	
Dimensions				
Installation flush (f) non flush (nf)				
Operating distance sn [mm]	5 f	7 nf	10 f	15 nf
WS ID-No.	P31356	P31357	P31358	P31359
Type	IGMW 005 WS	IGMW 008 WS	IGMW 010 WS	IGMW 015 WS
WO ID-No.	P31360	P31361	P31362	P31363
Type	IGMW 005 WO	IGMW 008 WO	IGMW 010 WO	IGMW 015 WO
Supply voltage WS/WO [V]	20...250 AC			
Switching current WS/WO [mA]	< 400			
Current consumption [mA]	< 2.5			
Voltage drop eff. [V]	< 5			
Switching frequency [Hz]	25			
Ambient temperature [°C]	-25...+120			
Compressive strength [bar]	10			
Minimum load current [mA]	5.0			
EMC-class	A			
Protection [EN 60529]	IP 68 + IP 69K			
Housing material	PTFE / AISI 316 Ti (A4)			
Connection	2 m FEP-cable 3x0.75 mm ²			
Switching current				

TROPICAL-Series • Resistant to rolling oil

Series IGFW / INFW - Proximity switches

PTFE housing

DC 10...55 V
AC 20...250 V

IP 68 Water-proofed
IP 69K Resistant to
high pressure cleaning



Design	DC PNP • M30x1.5	DC • Ø 35	AC • M30x1.5	AC • Ø 35
Dimensions				
Installation flush (f) non flush (nf)				
Operating distance sn [mm]	10 f	14 nf	10 f	14 nf
Switching output (DC PNP)				
ID-No.	P30628	P30640	P30626	P30638
Type	IGFW 010 GSP	IGFW 015 GSP	IGFW 010 WS	IGFW 015 WS
Supply voltage [V]	10...55 DC		20...250 AC	
Switching current [mA]	< 400		< 400	
Surge current [mA]	short circuit protection		< 3000 / 10 ms	
Current consumption [mA]	4		2.5	
Inverse current max. [µA]	1		2500	
Voltage drop [V]	2		5 eff.	
Ambient temperature [°C]	-25...+120			
Temperature deviation [%]	10 (-25...+70 °C), 20 (-25...+120 °C)			
Residual ripple [%]	10		-	
Overcurrent release approx. [mA]	430		-	
Reverse Protection	•		-	
Minimum load current [mA]	-		4.5	
EMC-class	A			
Switching frequency [Hz]	100		20	
Protection [EN 60529]	IP 68 + IP 69K			
Housing material	PTFE			
Connection	2 m FEP-cable 3x0.34 mm ²		2 m Silicone-cable 0.75 mm ²	
Switching current				
Accessories	nut M30x1.5 (Z00120), clamp Ø 35 (Z00125), page 3.67			

TROPICAL-Series • Resistant to rolling oil



Series IGMF / INFW - Proximity switches

DC 10...55 V

Climatic-protected
Resistant to acid

Armoured cable
with IP 68-plug

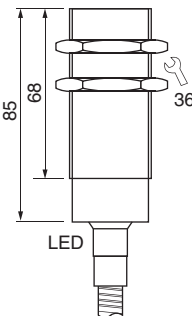
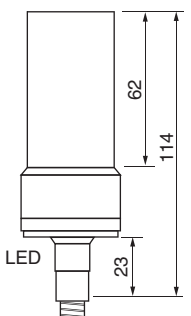

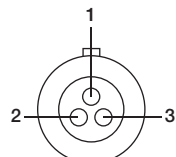
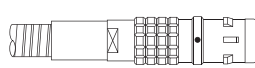
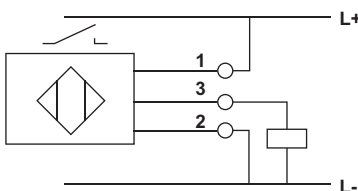
Design	DC PNP • M30x1.5	DC PNP • Ø35
Dimensions		
Installation flush (f) non flush (nf)		
Operating distance sn [mm] Switching output PNP	10 f 	20 nf 
ID-No.	P31215	P31216
Type	IGMF 010 GSP-PZ	INFW 020 GSP-PZ
Supply voltage [V]	10...55 DC	10...55 DC
Switching current max. [mA]	400	400
Current consumption [mA]	4	4
Switching frequency [Hz]	150	100
Ambient temperature [°C]	-25...+120	-25...+120
Compressive strength [bar]	10	-
Protection [EN 60529]	IP 68 + IP 69K	IP 68 + IP 69K
Function indicator	LED	LED
Housing material	PTFE, AISI 316 Ti	PTFE
Connection	5 m FEP-cable 3x0.34mm ² armoured cable	5 m FEP-cable 3x0.34mm ² armoured cable
Plug, Lemo series K, 3-pol	 	
Sensors without plug on request		
Accessories	junction box GS..., page 3.23	

Junction box • Resistant to rolling oil

Series GS 125 / GS 175 / GS 250

Connection of sensors with armoured cable

IP 68-plug



Design	GS 125	GS 175	GS 250
Dimensions			
ID-No.	P31212	P31217	P31218
Type	GS 125	GS 175	GS 250
Connectable sensors	2	3	4
Supply voltage [V]	10...55 DC	10...55 DC	10...55 DC
Ambient temperature [°C]	-20...+75	-20...+75	-20...+75
Protection [EN 60529]	IP 68	IP 68	IP 68
Housing material	Aluminium	Aluminium	Aluminium
Connection	10 m TPE-numbered cable 7x0.5mm ²	10 m TPE-numbered cable 7x0.5mm ²	10 m TPE-numbered cable 7x0.5mm ²

Plug, Lemo series K, 3-pol

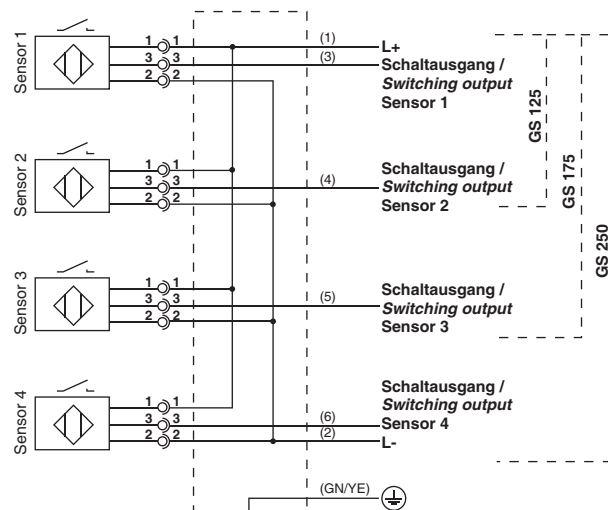
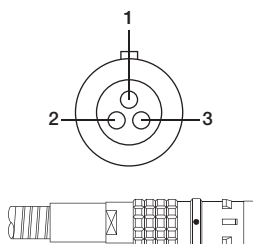

Notice

for sensors IGMF 010 GSP-PZ / INFW 020 GSP-PZ, page 3.22

High temperature 120 °C

Series IGMT - Proximity switches

M12 / M18 / M30

Metal sleeve

DC 10...48 V

Extended temperature range

-25 °C...+120 °C



Design	DC PNP • M12x1		DC PNP • M18x1		DC PNP • M30x1.5	
Dimensions						
Installation flush (f) non flush (nf)						
Operating distance sn [mm]	2 f	4 nf	5 f	8 nf	10 f	15 nf
Switching output PNP						
ID-No.	P31282	P31283	P31290	P31291	P31292	P31293
Type	IGMT 02 GSP	IGMT 04 GSP	IGMT 005 GSP	IGMT 008 GSP	IGMT 010 GSP	IGMT 015 GSP
Supply voltage [V]	10...48 DC					
Switching current [mA]	200					
Short circuit proof	•					
Reverse protection	•					
Voltage drop max. [V]	2					
Current consumption [mA]	4					
Switching frequency [Hz]	500					
Ambient temperature [°C]	-25...+120					
EMC-class	A					
Protection [EN 60529]	IP 67					
LED display	•					
Housing material	Br-Ni / PBT					
Connection	2 m Silicone-cable 3x0.34 mm ²					
Switching current						
Notes	design with M12 connector on request					

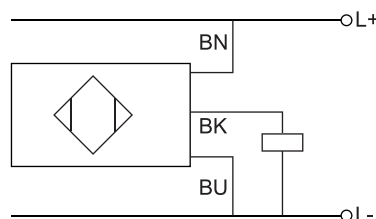

High temperature 120 °C

Series IGMT - Proximity switches

M18 / M30

Metal sleeve

AC 20...250 V

Extended temperature range

-25 °C...+120 °C



Design	AC • M18x1		AC • M30x1.5	
Dimensions				
Installation flush (f) non flush (nf)				
Operating distance sn [mm]	5 f	8 nf	10 f	15 nf
Switching output				
ID-No.	P31118	P31119	P31120	P31121
Type	IGMT 005 WS	IGMT 008 WS	IGMT 010 WS	IGMT 015 WS
Supply voltage [V]	20...250 AC			
Switching current [mA]	200			
Short circuit proof	-			
Reverse protection	-			
Voltage drop [V]	5			
Minimum load current [mA]	5			
Current consumption [mA]	2.5			
Switching frequency [Hz]	25			
Ambient temperature [°C]	-25...+120			
EMC-class	A			
Protection [EN 60529]	IP 67			
LED display	•			
Housing material	Br-Ni / PBT			
Connection	2 m Silicone-cable 3x0.75 mm ²			
Switching current				

High temperature 120 °C

Series IDT - Proximity switches

DC 10...55 V
AC 20...250 V

Extended
sensing range



Design	Ø80 mm		Ø105 mm		Ø160 mm		
Dimensions							
Installation non flush (nf)							
Operating distance sn [mm]	50 nf	45 nf	80 nf	60 nf	110 nf	100 nf	
Switching output (DC PNP)							
ID-No.	P31276	P31279	P31277	P31280	P31278	P31281	
Type	IDT 080 GSP	IDT 080 WS	IDT 105 GSP	IDT 105 WS	IDT 160 GSP	IDT 160 WS	
Supply voltage [V]	10...55 DC	20...250 AC	10...55 DC	20...250 AC	10...55 DC	20...250 AC	
Switching current [mA]	400	400	400	400	400	400	
Short circuit proof	•	-	•	-	•	-	
Reverse protection	•	-	•	-	•	-	
Voltage drop [V]	2	5 eff.	2	5 eff.	2	5 eff.	
Minimum load current [mA]	-	5	-	5	-	5	
Current consumption [mA]	4	2.5	4	2.5	4	2.5	
Switching frequency [Hz]	20	10	20	10	20	10	
Ambient temperature [°C]	-25...+120						
EMC-class	A						
Protection [EN 60529]	IP 67						
Housing material	PBT / Aluminium						
Connection	2 m Silicone-cable 3x0.34 mm ²	2 m Silicone-cable 2x0.75 mm ²	2 m Silicone-cable 3x0.34 mm ²	2 m Silicone-cable 2x0.75 mm ²	2 m Silicone-cable 3x0.34 mm ²	2 m Silicone-cable 2x0.75 mm ²	
Switching current							

High temperature 160 °C

Series IGMH - Proximity switches

M12 / M18 / M30

Stainless steel sleeve

DC 10...30 V

IP 68 Water-proofed

IP 69K Resistant to

high pressure cleaning



Design	DC PNP • M12x1		DC PNP • M18x1		DC PNP • M30x1.5	
Dimensions						
Installation flush (f) non flush (nf)						
Operating distance sn [mm]	2 f	4 nf	5 f	8 nf	10 f	15 nf
Switching output PNP						
ID-No.	P31288	P31289	P31161	P31162	P31163	P31164
Type	IGMH 02 GSP	IGMH 04 GSP	IGMH 005 GSP	IGMH 008 GSP	IGMH 010 GSP	IGMH 015 GSP
Supply voltage [V]	10...30 DC					
Switching current [mA]	200					
Short circuit proof	•					
Reverse protection	•					
Voltage drop max. [V]	2					
Residual current max. [mA]	0.02					
Current consumption (not actuated) [mA]	7					
Switching frequency [Hz]	200					
Temperature deviation [%]	15					
Ambient temperature [°C]	-25...+160					
EMC-class	A					
Protection [EN 60529]	IP 68 + IP 69K					
LED display	-					
Housing material	AISI 316 Ti / PEEK					
Connection	2 m FEP-cable 3x0.34 mm ²					

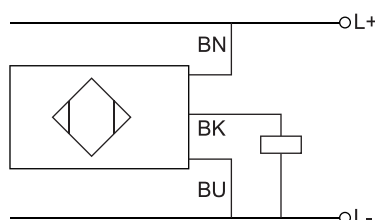
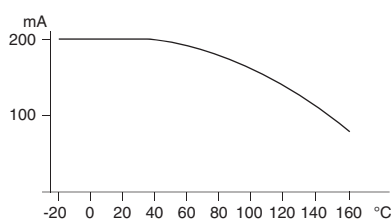

Notes temperature depending parameters are described in the technical manual

High temperature 160 °C

Series IGMH - Proximity switches

M12 / M18 / M30



Stainless steel sleeve

DC 10...30 V

Moisture resistant

Silicone-cable

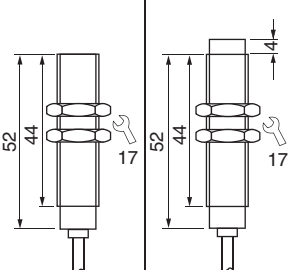
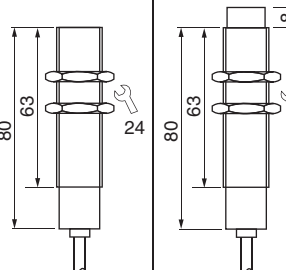
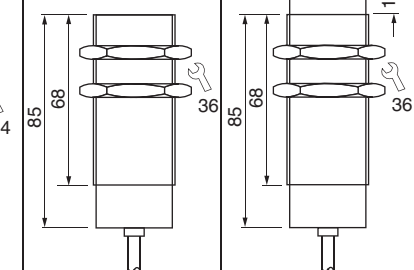

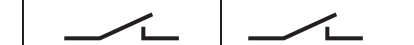
Design	DC PNP • M12x1		DC PNP • M18x1		DC PNP • M30x1.5	
Dimensions						
Installation flush (f) non flush (nf)						
Operating distance sn [mm]	2 f	4 nf	5 f	8 nf	10 f	15 nf
Switching output PNP						
ID-No.	P31299	P31300	P31301	P31302	P31303	P31304
Type	IGMH 02 GSP-K	IGMH 04 GSP-K	IGMH 005 GSP-K	IGMH 008 GSP-K	IGMH 010 GSP-K	IGMH 015 GSP-K
Supply voltage [V]	10...30 DC					
Switching current [mA]	200					
Short circuit proof	•					
Reverse protection	•					
Voltage drop max. [V]	2					
Residual current max. [mA]	0.02					
Current consumption (not actuated) [mA]	7					
Switching frequency [Hz]	200					
Temperature deviation [%]	15					
Ambient temperature [°C]	-25...+160					
EMC-class	A					
Protection [EN 60529]	IP 67					
LED display	-					
Housing material	AISI 316 Ti / PEEK					
Connection	2 m Silicone-cable 3x0.34 mm ²					

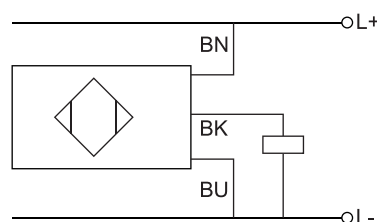
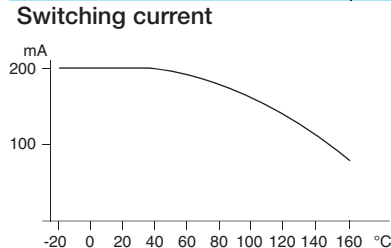

Notes

temperature depending parameters are described in the technical manual

High temperature 250 °C

Series IRH / IDH - Proximity sensor

Armoured cable

With connector for cable amplifier

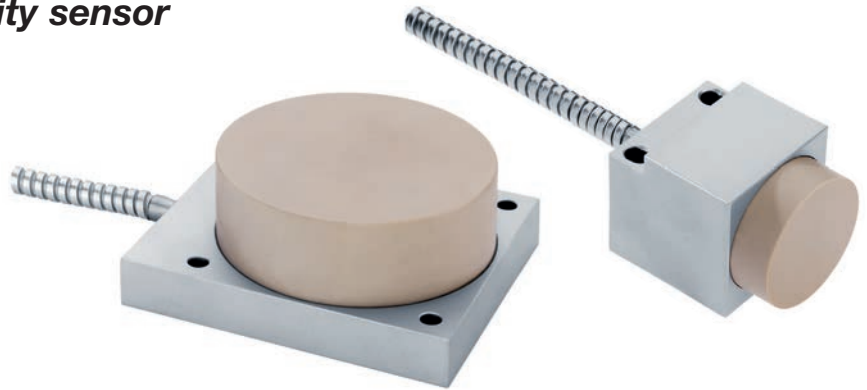

Design	Cuboid 40 mm	Ø80 mm	DC PNP • M30x1.5
Dimensions			
Installation non flush (nf)			
Operating distance sn [mm]	20 nf, adjustable	40 nf, adjustable	amplifier
Switching output PNP			
ID-No.	P31294	P31295	P31204
Type	IRH 040 S250	IDH 080 S250	IK 030 GSP
Supply voltage [V]	-	-	10...30
Switching current [mA]	-	-	200
Current consumption [mA]	-	-	15
Voltage drop [V]	-	-	1.5
Ambient temperature [°C]	0...+250	-	0...+70
Short circuit proof	-	-	•
Reverse protection	-	-	•
EMC-class	A	-	A
Switching frequency [Hz]	30	-	30
Protection [EN 60529]	IP 60	-	IP 67
Function indicator	-	-	LED yellow
Stand-by indicator	-	-	LED green
Housing material	Aluminium / PEEK		AISI 316 Ti
Connection cable	5 m FEP-cable, Ø8 mm armoured cable		-
Connection	M12 connector		M12 connector
Accessories	connecting cable SLG 3-2 (Z01076), page 3.65		



High temperature 250 °C

Series IGHS / IRHS / IDHS - Proximity sensor

Armoured cable

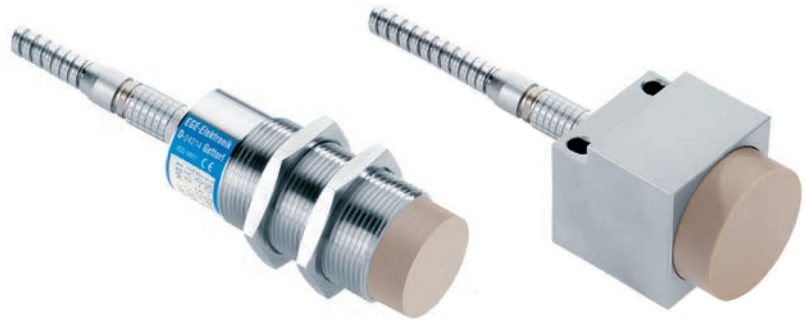
With connector for cable amplifier and sensor

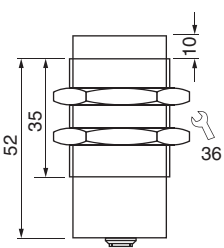
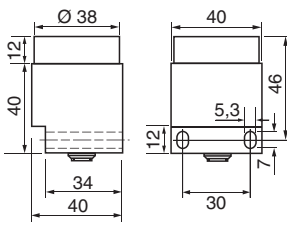
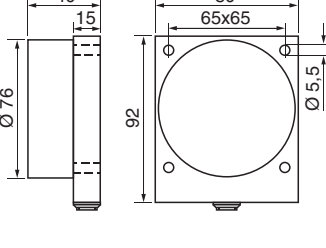

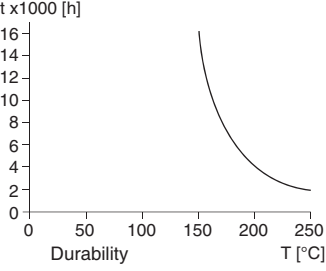
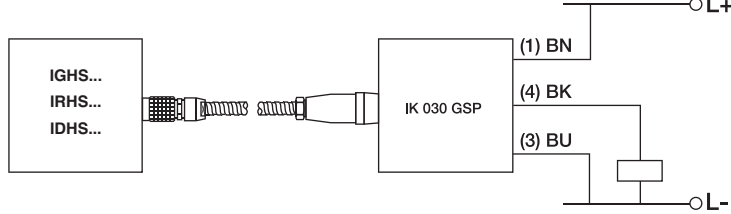
Design	M30x1.5	Cuboid 40 mm	Ø 80 mm
Dimensions			
Installation non flush (nf)			
Operating distance sn [mm]	15 nf, adjustable	20 nf, adjustable	40 nf, adjustable
ID-No.	P31298	P31296	P31297
Type	IGHS 030 S250	IRHS 040 S250	IDHS 080 S250
Supply voltage [V]		-	
Switching current [mA]		-	
Current consumption [mA]		-	
Voltage drop [V]		-	
Ambient temperature [°C]		0...+250	
Short circuit proof		-	
Reverse protection		-	
EMC-class		A	
Switching frequency [Hz]		30	
Protection [EN 60529]		IP 60	
Housing material	AISI 316 Ti / PEEK	Aluminium / PEEK	
Connection	M12 connector		
Connection cable (Accessories)	5 m FEP-cable, Ø 8 mm armoured cable (KAP 08-DS5, Z01190)		
			
			
Accessories	connecting cable SLG 3-2 (Z01076), page 3.65		

High temperature 200 °C

Series INT - Proximity sensor

PTFE housing

No cooling

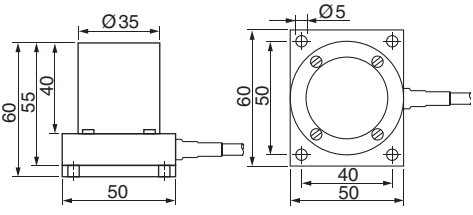
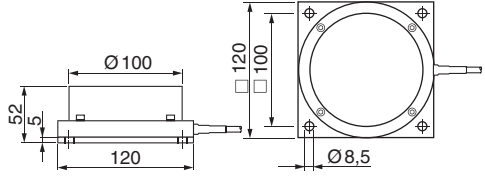
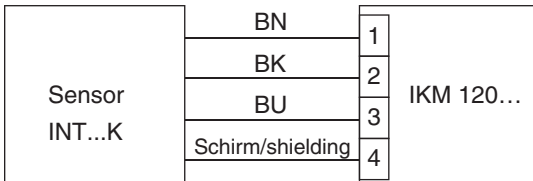
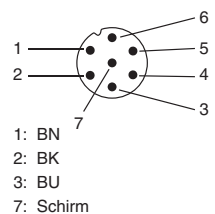

Design	INT020-S200		INT100-S180	
Dimensions				
Installation non flush (nf)				
Operating distance sn [mm]	15 nf		50 nf	
Adjustable range [mm]	5...20		10...80	
ID-No.	P31101	P30411	P31103	P30427
Type	INT020-S200 K	INT020-S200 GC	INT100-S180 K	INT100-S180 GC
Limiting temperature [°C]	250		200	
Nominal temperature [°C]	200		180	
Temperature deviation [mm/°C] (not linear)	0.05		0.06	
EMC-class	B			
Protection [EN 60529]	IP 40			
Housing material	PTFE			
Mounting	Aluminium plate			
Sensing material [ST 37]	40x40x1		100x100x1	
Connecting cable	5 m PTFE shielded			
Connection and required Amplifier	clamp connection IKM 120 GPP	plug C 16 IU 130...	clamp connection IKM 120 GPP	plug C 16 IU 130...
Special notes	<p>If the ambient temperature exceeds 230 °C, there might be failed reactions from the sensor, but it will not be destroyed by this. The inductive high temperature proximity switches must be used with an amplifier. The connection cable can be up to 10 m long. We can supply the cable with a flexible aluminium tube on request.</p>			
Connection diagram	<p>Sensor-Connection sensors INT...K to IKM 120 GPP</p> 		<p>Plug C 16: connection for Sensors INT...to IU 130...</p> 	
Amplifiers see page 3.32 - 3.33				
Temperature depending parameters are described in the technical manual				
Accessories	plug C 16			



Amplifier

Series IKM

For the connection of separate sensors for extreme temperatures

LED display

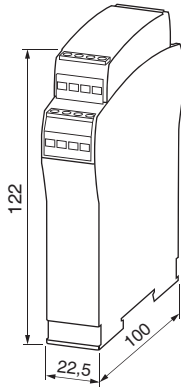

Design	IKM 120 GSOP
Dimensions	
ID-No.	P31334
Type	IKM 120 GSOP
Switching output	 PNP
Supply voltage [V]	24 V DC $\pm 20\%$
Switching current [mA]	400
Short circuit proof	•
Current consumption [mA]	max. 18
Operating distance	adjustable
Hysteresis max. [%]	10
Switching frequency [Hz]	100
Ambient temperature [°C]	-25...+75
EMC-class	A
Protection [EN 60529]	terminal: IP 20 / housing: IP 40
Function indicator	LED yellow
Stand-by indicator	LED green
Housing material	PA
Connection sensor	terminal screws
Connection Amplifier	terminal screws

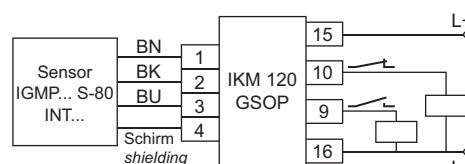

Amplifiers

Series IU

For the connection of separate sensors

LED display

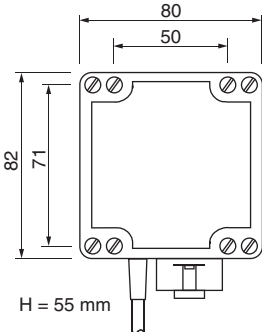
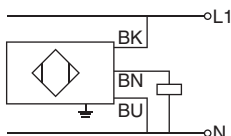
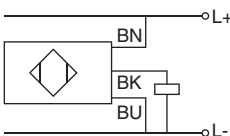

Design	IU 130...	
Dimensions		
ID-No.	P30438	P30439
Type	IU 130 WP	IU 130 GPP
Supply voltage [V]	230 AC ±10%	24 DC ±10%
Switching current [mA]	400	
Short circuit proof	-	
Current consumption [mA]	15	
Operating distance	adjustable	
Hysteresis max. [%]	adjustable	
Output	programmable	
Switching frequency [Hz]	5	15
Ambient temperature [°C]	-20...+70	
EMC-class	A	
Protection [EN 60529]	IP 67	
Function indicator	LED yellow	
Stand-by indicator	LED green	
Housing material	PBT	
Connection sensor	C 16 plug connection	
Connection amplifier	2 m PVC-cable 4x0.75 mm ²	2 m PVC-cable 3x0.50 mm ²
	<p>connection amplifier</p> 	<p>connection amplifier</p> 
Accessories	external plug C 16 (Z00039)	

Demanding environment

Series IGM - Proximity switches

M12 / M18 / M30

Metal sleeve

DC 10...48 V

Short form

Increased EMC

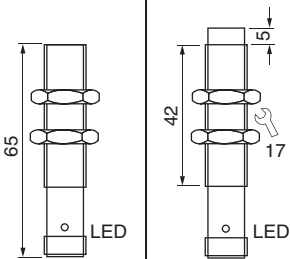
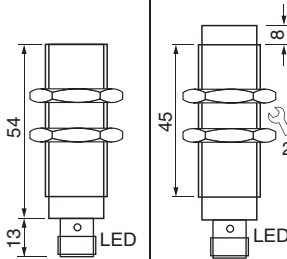
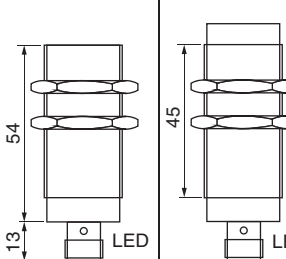

Design	DC PNP • M12x1		DC PNP • M18x1		DC PNP • M30x1.5	
Dimensions						
Installation flush (f) non flush (nf)	LED		LED		LED	
Operating distance sn [mm]	2 f	4 nf	5 f	8 nf	10 f	15 nf
GSP	ID-No. P31246	ID-No. P31247	ID-No. P31305	ID-No. P31306	ID-No. P31307	ID-No. P31308
	Type IGMU 02 GSP	Type IGMU 04 GSP	Type IGMU 05 GSP	Type IGMU 08 GSP	Type IGMU 10 GSP	Type IGMU 15 GSP
GSOP	ID-No. -	ID-No. -	ID-No. P31250	ID-No. P31251	ID-No. P31254	ID-No. P31255
	Type -	Type -	Type IGMU 05 GSOP	Type IGMU 08 GSOP	Type IGMU 10 GSOP	Type IGMU 15 GSOP
Supply voltage [V]	10...48 DC					
Switching current [mA]	200					
Short circuit proof	•					
Reverse protection	•					
Voltage drop [V]	2					
Current consumption [mA]	2.5					
Switching frequency [Hz]	500					
Ambient temperature [°C]	-25...+75					
EMC-class	A					
Protection [EN 60529]	IP 67					
LED display	•					
Housing material	Br-Ni / PBT					
Connection	M12 connector					

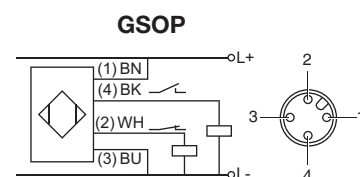
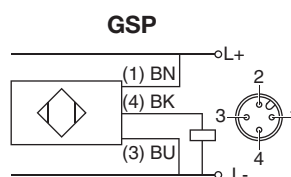

Accessories

connecting cable SLG 3-2 (GSP) / SLG 4-2 (GSOP), page 3.65

Demanding environment

Series IGM - Proximity switches

M12 / M18 / M30

Metal sleeve

DC 10...48 V

Short form

Increased EMC



Design	DC PNP • M12x1		DC PNP • M18x1		DC PNP • M30x1.5	
Dimensions						
Installation flush (f) non flush (nf)	f		nf		nf	
Operating distance sn [mm]	2 f	4 nf	5 f	8 nf	10 f	15 nf
GSP ID-No.	P31244	P31245	P31309	P31310	P31311	P31312
Type	IGM 02 GSP	IGM 04 GSP	IGM 05 GSP	IGM 08 GSP	IGM 10 GSP	IGM 15 GSP
GSOP ID-No.	-	-	P31248	P31249	P31252	P31253
Type	-	-	IGM 05 GSOP	IGM 08 GSOP	IGM 10 GSOP	IGM 15 GSOP
Supply voltage [V]	10...48 DC					
Switching current [mA]	200					
Short circuit proof	•					
Reverse protection	•					
Voltage drop [V]	2					
Current consumption [mA]	2.5					
Switching frequency [Hz]	500					
Ambient temperature [°C]	-25...+75					
EMC-class	A					
Protection [EN 60529]	IP 67					
LED display	•					
Housing material	Br-Ni / PBT					
Connection	GSP: 2 m PVC-cable 3x0.34 mm ²			GSOP: 2 m PVC-cable 4x0.34 mm ²		

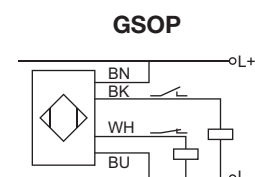
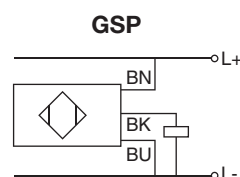

Demanding environment

Series IGM - Proximity switches

M18 / M30
Metal sleeve

DC 10...48 V
AC 20...250 V

Long form

Increased EMC



Design	DC PNP • M18x1		DC PNP • M30x1.5		AC • M30x1.5 programmable	
Dimensions						
Installation flush (f) non flush (nf)	13	8	13	10	13	20
Operating distance sn [mm]	5 f	8 nf	10 f	15 nf	10 f	15 nf
GSP	ID-No. P31313 Type IGMU 005 GSP	ID-No. P31314 Type IGMU 008 GSP	ID-No. P31315 Type IGMU 010 GSP	ID-No. P31316 Type IGMU 015 GSP	-	-
GSOP	ID-No. P31258 Type IGMU 005 GSOP	ID-No. P31259 Type IGMU 008 GSOP	ID-No. P31262 Type IGMU 010 GSOP	ID-No. P31263 Type IGMU 015 GSOP	-	-
WP	-	-	-	-	ID-No. P30015 Type IGMS 010 WP	ID-No. P30019 Type IGMS 015 WP
Supply voltage [V]	10...48 DC				20...250 AC	
Switching current [mA]	200				400	
Short circuit proof	•				3000 mA/10 ms	
Reverse protection	•				-	
Voltage drop [V]	2				6	
Minimum load current [mA]	-				5	
Current consumption [mA]	2.5				2.5	
Switching frequency [Hz]	500				25	
Ambient temperature [°C]	-25...+75				-25...+75	
EMC-class	A				A	
Protection [EN 60529]	IP 67				IP 67	
LED display	•				•	
Housing material	Br-Ni / PBT				Br-Ni / PBT	
Connection	M12 connector				PG-plug connection 2 m PVC-cable 3x0.5 mm ²	
Accessories	connecting cable SLG 3-2 (GSP) / SLG 4-2 (GSOP), page 3.65					

Demanding environment

Series IGM - Proximity switches

M18 / M30
Metal sleeve

DC 10...48 V
AC 20...250 V

Long form

Increased EMC



Design	DC PNP • M18x1		DC PNP • M30x1.5		AC • M30x1.5	
Dimensions						
Installation flush (f) non flush (nf)						
Operating distance sn [mm]	5 f	8 nf	10 f	15 nf	10 f	15 nf
GSP	ID-No. P31317 Type IGM 005 GSP	ID-No. P31318 Type IGM 008 GSP	ID-No. P31319 Type IGM 010 GSP	ID-No. P31320 Type IGM 015 GSP	-	-
GSOP	ID-No. P31256 Type IGM 005 GSOP	ID-No. P31257 Type IGM 008 GSOP	ID-No. P31260 Type IGM 010 GSOP	ID-No. P31261 Type IGM 015 GSOP	-	-
WS	ID-No. - Type -	ID-No. - Type -	ID-No. - Type -	ID-No. - Type -	P30016 IGM 010 WS	P30020 IGM 015 WS
Supply voltage [V]	10...48 DC				20...250 AC	
Switching current [mA]	200				400	
Short circuit proof	•				3000 mA/10 ms	
Reverse protection	•				-	
Voltage drop [V]	2				6	
Minimum load current [mA]	-				5	
Current consumption [mA]	2.5				2.5	
Switching frequency [Hz]	500				25	
Ambient temperature [°C]	-25...+75				-25...+75	
EMC-class	A				A	
Protection [EN 60529]	IP 67				IP 67	
LED display	•				•	
Housing material	Br-Ni / PBT				Br-Ni / PBT	
Connection	GSP: 2 m PVC-cable, 3x0.34 mm ² GSOP: 2 m PVC-cable, 4x0.34 mm ²				2 m PVC-cable 3x0.5 mm ²	

Demanding environment

Series ID - Proximity switches

Ø80 mm

DC 10...55 V
AC 20...250 V

Sensing range adjustable

Increased EMC



Design	DC PNP • Ø80 mm	DC PNP • Ø80 mm	AC • Ø80 mm programmable
Dimensions			
Installation non flush (nf)			
Operating distance sn [mm] (Adjustable range)	55 nf (25...80)	55 nf (25...80)	55 nf (25...80)
GSP ID-No. Type	P31321 IDU 080 GSP	P31322 ID 080 GSP	-
GSOP ID-No. Type	P31264 IDU 080 GSOP	P31265 ID 080 GSOP	-
WP ID-No. Type	-	-	P31266 IDS 080 WP
Supply voltage [V]	10...55 DC	10...55 DC	20...250 AC
Switching current [mA]	400	400	400
Short circuit proof	•	•	3000 mA/10 ms
Reverse protection	•	•	-
Voltage drop [V]	2	2	6 eff.
Minimum load current [mA]	-	-	8
Current consumption [mA]	4	4	2.5
Switching frequency [Hz]	20	20	10
Ambient temperature [°C]	-25...+75	-25...+75	-25...+75
EMC-class	A	A	A
Protection [EN 60529]	IP 67	IP 67	IP 67
LED display	•	•	•
Housing material	PBT	PBT	PBT
Connection	M12 connector	GSP: 2 m PVC-cable, 3x0.5 mm ² GSOP: 2 m PVC-cable, 4x0.5 mm ²	PG-plug connection 2 m, 2x0.75 mm ² , PVC
Accessories	connecting cable SLG 3-2 (GSP) / SLG 4-2 (GSOP), page 3.65		

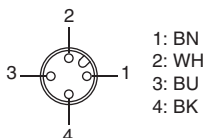

Demanding environment

Series ID - Proximity switches

Ø 105 mm

DC 10...55 V
AC 20...250 V

Sensing range adjustable

Increased EMC

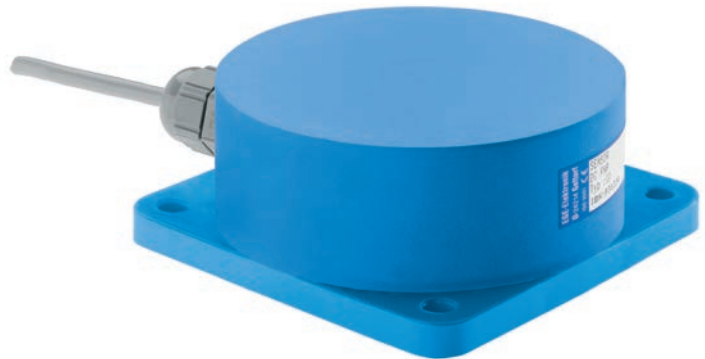

Design	DC PNP • Ø 105 mm	DC PNP • Ø 105 mm	AC • Ø 105 mm programmable
Dimensions Installation non flush (nf)			
Operating distance sn [mm] (Adjustable range)	100 nf (20...110)	100 nf (20...110)	70 nf (20...110)
GSP ID-No. Type	P31323 IDU 105 GSP	P31324 ID 105 GSP	-
GSOP ID-No. Type	P31267 IDU 105 GSOP	P31268 ID 105 GSOP	-
WP ID-No. Type	-	-	P31269 IDS 105 WP
Supply voltage [V]	10...55 DC	10...55 DC	20...250 AC
Switching current [mA]	400	400	400
Short circuit proof	•	•	3000 mA/10 ms
Reverse protection	•	•	-
Voltage drop [V]	2	2	6 eff.
Minimum load current [mA]	-	-	8
Current consumption [mA]	4	4	2.5
Switching frequency [Hz]	20	20	10
Ambient temperature [°C]	-25...+75	-25...+75	-25...+75
EMC-class	A	A	A
Protection [EN 60529]	IP 67	IP 67	IP 67
LED display	•	•	•
Housing material	PBT	PBT	PBT
Connection	M12 connector	GSP: 2 m PVC-cable, 3x0.5 mm ² GSOP: 2 m PVC-cable, 4x0.5 mm ²	PG-plug connection 2 m, 2x0.75 mm ² , PVC
 1: BN 2: WH 3: BU 4: BK	GSP 	GSOP 	WP
Accessories	connecting cable SLG 3-2 (GSP) / SLG 4-2 (GSOP), page 3.65		

Demanding environment

Series ID - Proximity switches





Ø 160 mm

DC 10...55 V
AC 20...250 V

Sensing range adjustable

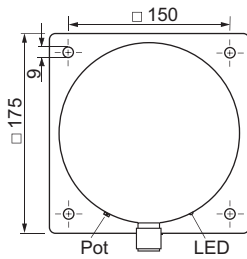
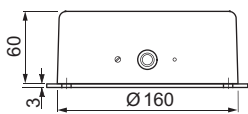
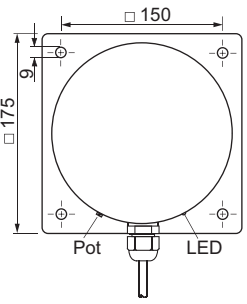
Increased EMC

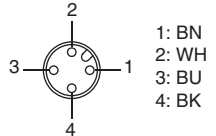
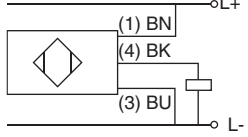
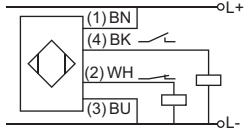
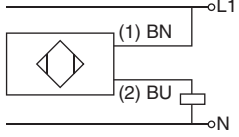

Design	DC PNP • Ø 160 mm	DC PNP • Ø 160 mm	AC • Ø 160 mm programmable
Dimensions Installation non flush (nf)			
Operating distance sn [mm] (Adjustable range)	120 nf (20...150)	120 nf (20...150)	120 nf (20...150)
GSP  ID-No. P31325 Type IDU 160 GSP		P31326 ID 160 GSP	-
GSOP  ID-No. P31270 Type IDU 160 GSOP		P31271 ID 160 GSOP	-
WP  ID-No. - Type -		-	P31272 IDS 160 WP
Supply voltage [V]	10...55 DC	10...55 DC	20...250 AC
Switching current [mA]	400	400	400
Short circuit proof	•	•	3000 mA/10 ms
Reverse protection	•	•	-
Voltage drop [V]	2	2	6 eff.
Minimum load current [mA]	-	-	8
Current consumption [mA]	4	4	2.5
Switching frequency [Hz]	20	20	10
Ambient temperature [°C]	-25...+75	-25...+75	-25...+75
EMC-class	A	A	A
Protection [EN 60529]	IP 67	IP 67	IP 67
LED display	•	•	•
Housing material	PBT / Aluminium	PBT / Aluminium	PBT / Aluminium
Connection	M12 connector	GSP: 2 m PVC-cable, 3x0.5 mm ² GSOP: 2 m PVC-cable, 4x0.5 mm ²	PG-plug connection 2 m, 2x0.75 mm ² , PVC
	GSP 	GSOP 	WP 

Accessories

connecting cable SLG 3-2 (GSP) / SLG 4-2 (GSOP), page 3.65

Demanding environment

Series ID - Proximity switches

Ø 200 mm

DC 10...55 V
AC 20...250 V

Sensing range adjustable

Increased EMC



Design	DC PNP • Ø200 mm	DC PNP • Ø200 mm	AC • Ø200 mm programmable
Dimensions Installation non flush (nf)			
Operating distance sn [mm] (Adjustable range)	140 nf (40...170)	140 nf (40...170)	140 nf (40...170)
GSP ID-No. Type P31327 IDU 200 GSP		P31328 ID 200 GSP	-
GSOP ID-No. Type P31273 IDU 200 GSOP		P31274 ID 200 GSOP	-
WP ID-No. Type - -			P31275 IDS 200 WP
Supply voltage [V]	10...55 DC	10...55 DC	20...250 AC
Switching current [mA]	400	400	400
Short circuit proof	•	•	3000 mA/10 ms
Reverse protection	•	•	-
Voltage drop [V]	2	2	6 eff.
Minimum load current [mA]	-	-	8
Current consumption [mA]	4	4	2.5
Switching frequency [Hz]	20	20	10
Ambient temperature [°C]	-25...+75	-25...+75	-25...+75
EMC-class	A	A	A
Protection [EN 60529]	IP 67	IP 67	IP 67
LED display	•	•	•
Housing material	PBT / Aluminium	PBT / Aluminium	PBT / Aluminium
Connection	M12 connector	GSP: 2 m PVC-cable, 3x0.5 mm ² GSOP: 2 m PVC-cable, 4x0.5 mm ²	PG-plug connection 2 m, 2x0.75 mm ² , PVC
	GSP 	GSOP 	WP
Accessories	connecting cable SLG 3-2 (GSP) / SLG 4-2 (GSOP), page 3.65		





Analog output

Series IGA - Proximity sensors

M12 / M18
Metal sleeve

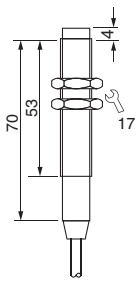
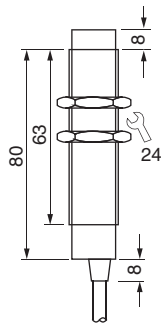
0...10 V
4...20 mA

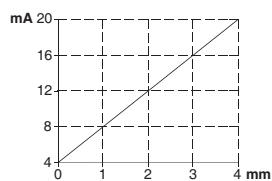
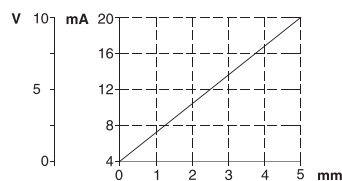
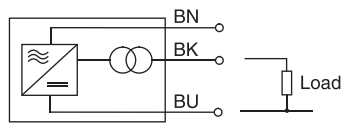

Design	M12x1	M18x1	M18x1
Dimensions			
Installation non flush (nf)			
Analog range [mm]	0...4 nf	0...5 nf	0...5 nf
Output			
ID-No.	4...20 mA P31128	0...10 V P31040	4...20 mA P31129
Type	IGA 104 GI	IGA 005 GU	IGA 005 GI
Supply voltage [V]	18...27 DC	18...27 DC	18...27 DC
Current consumption max. [mA]	40	25	40
Voltage output max. [V]	-	11	-
Output current max. [mA]	23	-	23
Linearity deviation [%]	10	5	5
Load resistance R _L [kΩ]	<0.4	>2	<0.4
Ambient temperature [°C]		-25...+70	
Temperature deviation [%]		10	
Protection [EN 60529]		IP 67	
Housing material		Br-Ni / PBT	
Connecting	2 m PVC-cable 3x0.34 mm ²	2 m PVC-cable 3x0.5 mm ²	
Output signal with approaching iron plate ST37			
Connection diagram			

Analog output

Series IGA / IDA - Proximity sensors

M30
Ø 80 mm

0...10 V
4...20 mA



Design	M30x1.5		Ø 80 mm	
Dimensions				
Installation non flush (nf)				
Analog range [mm]	0...10 nf	0...10 nf	0...30 nf	0...30 nf
Output				
ID-No.	0...10 V P31041	4...20 mA P31130	0...10 V P31043	4...20 mA P31131
Type	IGA 010 GU	IGA 010 GI	IDA 030 GU	IDA 030 GI
Supply voltage [V]	18...27 DC	18...27 DC	18...27 DC	18...27 DC
Current consumption max. [mA]	25	40	25	40
Voltage output max. [V]	11	-	11	-
Output current max. [mA]	-	23	-	23
Linearity deviation [%]	5			
Load resistance R _L [kΩ]	>2	<0.4	>2	<0.4
Ambient temperature [°C]	-25...+70			
Temperature deviation [%]	10			
Protection [EN 60529]	IP 67			
Housing material	Br-Ni / PBT		PBT	
Connection	2 m PVC-cable 3x0.5 mm ²			
Output signal with approaching iron plate ST37				
Connection diagram				

Inductive Sensors



Analog • High temperature 160 °C

Series IGT - Proximity sensors

M18

4...20 mA

For the connection to amplifier IKM 120 GA

Permanent temperature 160 °C

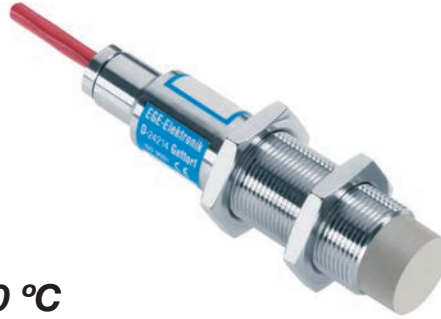

Design	IGT 005	IKM 120 GA
Dimensions		
Installation non flush (nf)		
Analog range [mm]	0...5 nf	-
ID-No.	P31143	P31144
Type	IGT 005	IKM 120 GA
Supply voltage [V]	-	24 DC ±20%
Current consumption [mA]	-	30
Current output [mA]	-	4...20 mA
Linearity [%]	6	0.5
Load R _L [Ω]	-	50...500
Ambient temperature [°C]	-25...+160	-20...+60
Temperature deviation [%]	10	2
Protection [EN 60529]	IP 67	IP 40
Housing material	AISI 316 Ti / PKS	PC
Connection	2 m PTFE 3x0.75 mm ²	terminal screws
Output signal with approaching iron plate ST37		
Connection diagramm		

Standard switches

Series IGM - Proximity switches

M8 / M12

Metal sleeve

DC 10...30 V

Euronorm



Design	M8x1	DC PNP • M12x1			DC PNP • M12x1
Dimensions					
Installation flush (f) non flush (nf)					
Operating distance sn [mm] Switching output PNP	1.5 f	2 f	4 nf	2 f	4 nf
ID-No.	P31013	P31104	P31105	P31106	P31107
Type	IGM 1 GSP	IGM 102 GSP	IGM 104 GSP	IGMU 102 GSP	IGMU 104 GSP
Supply voltage [V]	10...30 DC	10...30 DC	10...30 DC	10...30 DC	10...30 DC
Switching current [mA]	200	200	200	200	200
Short circuit proof	•	•	•	•	•
Overcurrent release [mA]	250	250	250	250	250
Reverse protection	•	•	•	•	•
Voltage drop max. [V]	2	2	2	2	2
Residual current [mA]	-	-	-	-	-
Current consumption (not actuated) [mA]	<11	<5	<5	<5	<5
Switching frequency [Hz]	1000	800	400	800	400
Ambient temperature [°C]	-25...+70	-25...+70	-25...+70	-25...+70	-25...+70
EMC-class	A	A	A	A	A
Protection [EN 60529]	IP 67	IP 67	IP 67	IP 67	IP 67
LED display	•	•	•	•	•
Housing material	Stainless steel / PA	Br-Ni / PPO	Br-Ni / PPO	Br-Ni / PPO	Br-Ni / PPO
Connection	2 m PVC-cable 3x0.14 mm ²	2 m PVC-cable 3x0.14 mm ²	2 m PVC-cable 3x0.14 mm ²	M12 connector	M12 connector
Accessories					

connecting cable SLG 3-2, page 3.65

Standard switches

Serie IGM - Proximity switches





M18

Metal sleeve

DC 10...30 V

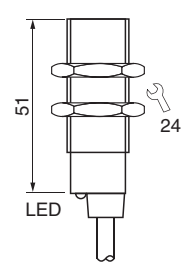
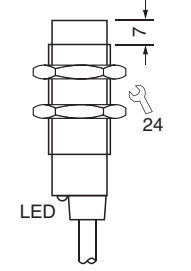
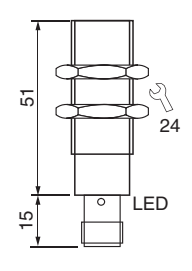
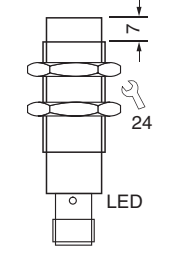
Euronorm

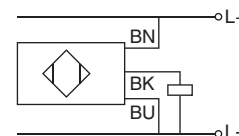
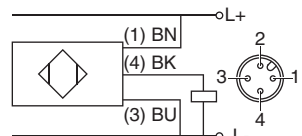

Design	DC PNP • M18x1		DC PNP • M18x1	
Dimensions				
Installation flush (f) non flush (nf)				
Operating distance sn [mm] Switching output PNP	5 f 	8 nf 	5 f 	8 nf 
ID-No.	P31110	P31111	P31112	P31113
Type	IGM 105 GSP	IGM 108 GSP	IGMU 105 GSP	IGMU 108 GSP
Supply voltage [V]	10...30 DC	10...30 DC	10...30 DC	10...30 DC
Switching current [mA]	200	200	200	200
Short circuit proof	•	•	•	•
Overcurrent release [mA]	250	250	250	250
Reverse protection	•	•	•	•
Voltage drop max. [V]	1.5	1.5	1.5	1.5
Residual current [mA]	-	-	-	-
Current consumption (not actuated) [mA]	1	1	1	1
Switching frequency [Hz]	500	200	500	200
Ambient temperature [°C]	-25...+70	-25...+70	-25...+70	-25...+70
EMC-class	A	A	A	A
Protection [EN 60529]	IP 67	IP 67	IP 67	IP 67
LED display	•	•	•	•
Housing material	Br-Ni / PPO	Br-Ni / PPO	Br-Ni / PPO	Br-Ni / PPO
Connection	2 m PVC-cable 3x0.5 mm ²	2 m PVC-cable 3x0.5 mm ²	M12 connector	M12 connector
Accessories				

connecting cable SLG 3-2, page 3.65

Standard switches

Series INK - Proximity switches

Smooth-bodied switch

Ø 20 mm / Ø 34 mm

DC 10...55 V

Sensors with AC voltage are available on request



Design	DC PNP		DC PNP programmable	
	Ø 20 mm	Ø 34 mm	Ø 20 mm	Ø 34 mm
Dimensions				
Installation non flush (nf)				
Operating distance sn [mm]	10 nf	20 nf	10 nf	20 nf
Switching output PNP				
ID-No.	P30159	P30166	P30158	P30165
Type	INK 010 GSP	INK 020 GSP	INKS 010 GPP	INKS 020 GPP
Supply voltage [V]	10...55 DC	10...55 DC	10...55 DC	10...55 DC
Switching current [mA]	400	400	400	400
Short circuit proof	•	•	•	•
Overcurrent release [mA]	450	450	450	450
Reverse protection	•	•	•	•
Voltage drop max. [V]	2	2	2	2
Residual current [mA]	-	-	-	-
Current consumption (not actuated) [mA]	2.5	2.5	2.5	2.5
Switching frequency [Hz]	1500	500	1500	500
Ambient temperature [°C]	-25...+75	-25...+75	-25...+75	-25...+75
EMC-class	A	A	A	A
Protection [EN 60529]	IP 67	IP 67	IP 67	IP 67
LED display	•	•	•	•
Housing material	PBT	PBT	PBT	PBT
Connection	2 m PVC-cable 3x0.5 mm ²	2 m PVC-cable 3x0.5 mm ²	2 m PVC-cable 3x0.5 mm ² (PG-plug connection)	2 m PVC-cable 3x0.5 mm ² (PG-plug connection)
PG-plug connection				
DC 1: BN 2: BU 3: BK				
Schalter / switch Disconnect power supply before pulling off plug connector. Spannungsversorgung abschalten bevor Steckverbindung gezogen wird.				
Accessories	mounting clamps Ø 20 mm (Z00100), Ø 34 mm (Z00102) are part of delivery			

Special functions • Surface sensor

Series IFE - Proximity switches

Wide detection range



DC 10...55 V

Sensitivity adjustable

Moisture-resistant

PG-plug IP 68

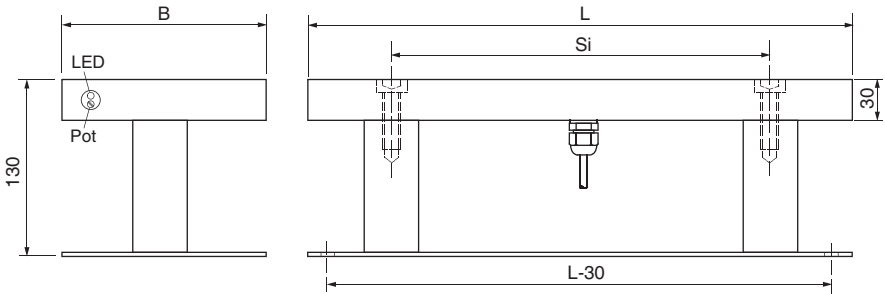

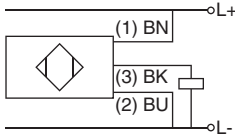
Design	DC PNP					
Dimensions						
Installation non flush (nf)						
Operating distance sn [mm]	100 nf	100 nf	130 nf	150 nf	180 nf	
Adjustable range max.	120	150	170	200	250	
Switching output PNP						
ID-No.	P31016	P31018	P31020	P31022	P31024	
Type	IFE 200/100 GSP	IFE 400/100 GSP	IFE 400/150 GSP	IFE 700/150 GSP	IFE 900/150 GSP	
Dimensions	L	200	400	400	700	900
	B	100	100	150	150	150
	Si	108	280	230	190	182
Supply voltage [V]	10...55 DC					
Switching current [mA]	<400					
Short circuit protection	•					
Overcurrent release approx. [mA]	430					
Reverse protection	•					
Current consumption approx. [mA]	4					
Inverse current max. [µA]	1					
Residual ripple max. [%]	15					
Voltage drop approx. [V]	2					
Switching frequency [Hz]	10					
Hysteresis [%]	10					
Ambient temperature [°C]	-25...+75					
Correction factors	St 37: 1	AL: 0.4	VA 4: 0.65	Cu: 0.45	ZN: 0.5	MS: 0.6
EMC-class	A					
Protection [EN 60529]	IP 68					
Housing material	PVC / Aluminium					
Connection	PG-plug connection, 2 m PVC-cable 3x0.5 mm ²					
						
Notes	see page 3.06					

Special functions • Surface sensor

Series IFE - Proximity switches

Wide detection range



AC 20...250 V

Sensitivity adjustable

Moisture-resistant

PG-plug IP 68

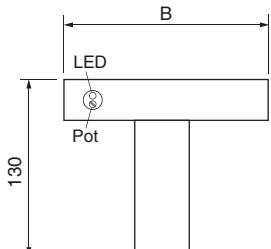
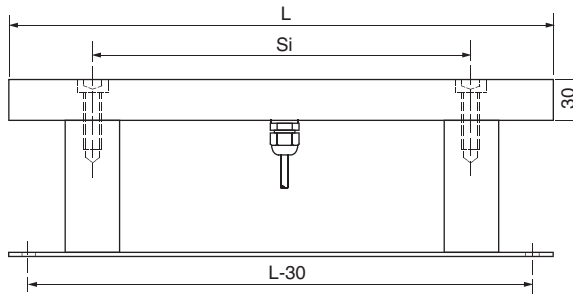

Design	AC					
Dimensions						
Installation non flush (nf)	130					
Operating distance sn [mm]	100 nf	100 nf	130 nf	150 nf	180 nf	
Adjustable range max.	120	150	170	200	250	
Switching output						
ID-No.	P31015	P31017	P31019	P31021	P31023	
Type	IFE 200/100 WS	IFE 400/100 WS	IFE 400/150 WS	IFE 700/150 WS	IFE 900/150 WS	
Dimensions	L	200	400	400	700	900
	B	100	100	150	150	150
	Si	108	280	230	190	182
Supply voltage [V]	20...250 AC					
Switching current [mA]	< 400					
Surge current [mA]	< 3000 / 10 ms					
Overcurrent release approx. [mA]	-					
Current consumption approx. [mA]	2.5					
Inverse current approx. [mA]	2.5					
Minimum load current approx. [mA]	6					
Voltage drop approx. [V]	6					
Switching frequency [Hz]	10					
Hysteresis [%]	10					
Ambient temperature [°C]	-25...+75					
Correktion factors	St 37: 1	AL: 0.4	VA 4: 0.65	Cu: 0.45	ZN: 0.5	MS: 0.6
EMC-class	A					
Protection [EN 60529]	IP 68					
Housing material	PVC					
Connection	PG-plug connection, 2 m PVC-cable 2x0.75 mm²					
Notes	see page 3.06					

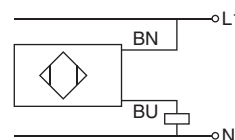

Special functions • Offshore



Series IGMO - Proximity switches

M12 / M18

DC 10...30 V

High compressive strength
Longitudinal water blocked cable
Sea water proofed

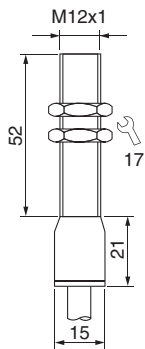
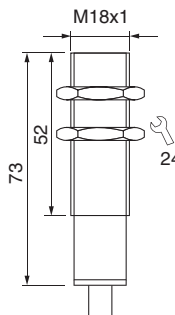

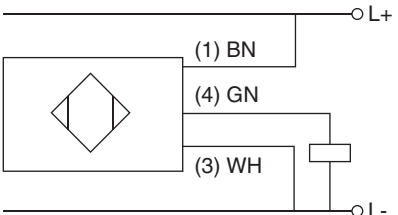
Design	DC PNP • M12x1	DC PNP • M18x1
Dimensions		
Installation flush (f)		
Operating distance sn [mm]	2 f	5 f
Switching output PNP		
ID-No.	P31223	P31224
Type	IGMO 02 GSP	IGMO 05 GSP
Supply voltage [V]	10...30 DC	
Switching current [mA]	200	
Short circuit proof	•	
Reverse protection	•	
Current consumption [mA]	4	
Switching frequency [Hz]	200	
Ambient temperature [°C]	-25...+70	
Compressive strength [bar]	30	
Protection [EN 60529]	IP 68	
Housing material	PTFE / AISI 316 Ti	
Sealing material	FKM	
Connection	1 m longitudinal water blocked cable	
		

Special functions • Washing resistant

Series IDKW - Proximity switches

DC 10...30 V



110 °C Permanent temperature

Resistant to hot steam

Resistant to detergents

IP 68 + IP 69K

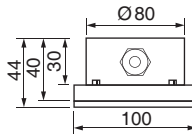
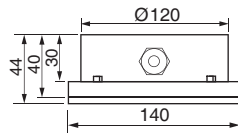
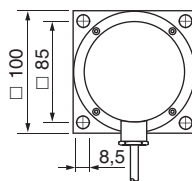
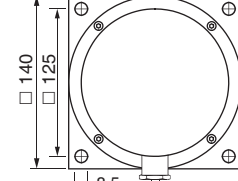

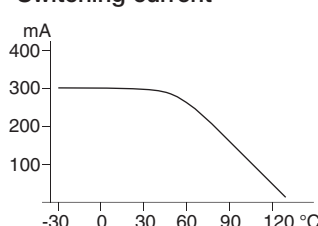
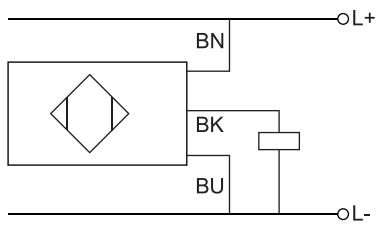
Design	DC PNP • Ø80 mm	DC PNP • Ø120 mm
Dimensions		
Installation non flush (nf)		
Operating distance sn [mm]	55 nf	90 nf
Switching output PNP		
ID-No.	P31214	P31177
Type	IDKW 080 GSP	IDKW 120 GSP
Supply voltage [V]	10...30 DC	
Switching current [mA]	300	
Hysteresis	<0.1 Sn	
Voltage drop max. [V]	2	
Current consumption [mA]	10	
Switching frequency [Hz]	30	
Ambient temperature [°C]	-20...+110	
Limiting temperature [°C]	120	
Temperature deviation [%]	≤10	
EMC-class	A	
Protection [EN 60529]	IP 68 + IP 69K	
Housing material	PP / AISI 316 Ti	
Sealing material	EPDM	
Connection	5 m FEP-cable 3x0.75 mm ² , shielded	
Switching current		
		

Special functions • Factor 1

Series IGB / IDB - Proximity switches

M30
Ø 80 mm / Ø 160 mm

DC 10...30 V

Correction factor 1
for all metals



Design	M30x1.5	M30x1.5	Ø 80 mm	Ø 160 mm
Dimensions				
Installation flush (f) non flush (nf) adjustable (a)				
Operating distance sn [mm] Switching output PNP	10 f	20 nf	70 nf-a	150 nf-a
ID-No.	P31135	P31136	P31141	P31142
Type	IGBS 010 GSP	IGBS 020 GSP	IDBS 080 GPP	IDBS 160 GPP
Supply voltage [V]	10...30 DC			
Switching current [mA]	200			
Short circuit proof	•			
Current consumption [mA]	25			
Reverse protection	•			
Voltage drop max. [V]	2			
Switching frequency [Hz]	300		20	
Ambient temperature [°C]	-25...+75			
EMC-class	A			
Protection [EN 60529]	IP 67			
Housing material	Br-Ni / PBT		PBT / Aluminium	
Connection	M12 connector		PG-plug connection 2 m, 3x0.5 mm ² PVC	
PG-plug-system				
<p>AC DC</p> <p>1: BN 1: BN</p> <p>2: BU 2: BU</p> <p>3: BK 3: BK</p> <p>Schalter / switch</p> <p>Disconnect power supply NO before pulling off plug connector. Spannungsversorgung abschalten bevor Steckverbindung gezogen wird.</p>				

Dust - Compact model • Zone 20





Series IGEX20 - Proximity switches

Category 1

Dust  Zone 20

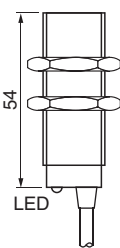
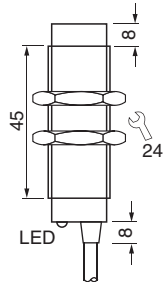
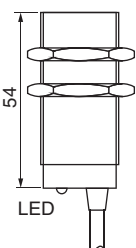
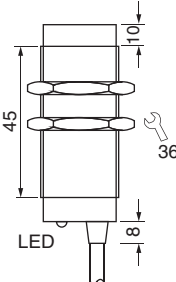
Direct connection to DC 24 V
PNP switching output

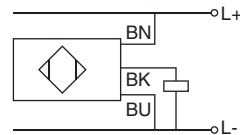

Design	DC PNP • M18x1		DC PNP • M30x1.5	
Dimensions				
Installation flush (f) non flush (nf)				
Operating distance [mm]	5 f	8 nf	10 f	15 nf
Switching output PNP				
ID-No.	P31178	P31179	P31180	P31181
Type	IGEX20 05 GSP	IGEX20 08 GSP	IGEX20 10 GSP	IGEX20 15 GSP
Ex marking	II 1D Ex ma IIIC T 80 °C Da IP 67			
Certificate No.	TÜV 05 ATEX 2845 X			
Supply voltage [V]	10...30 DC			
Switching current [mA]	100			
Short circuit proof	•			
Reverse protection	•			
Voltage drop max. [V]	2			
Residual current [mA]	-			
Current consumption [mA]	7			
Switching frequency [Hz]	200			
Ambient temperature [°C]	-20...+70			
EMC-class	A			
Protection [EN 60529]	IP 67			
LED display	•			
Housing material	Br-Ni / PA			
Connection	2 m PVC-cable 3x0.5 mm ²			
				
Accessories	housing for screw terminals series GK...			

Series IGEX - Proximity switches

Category 1

Dust Ex Zone 20

Gas Ex Zone 0

NAMUR (EN 60947-5-6)

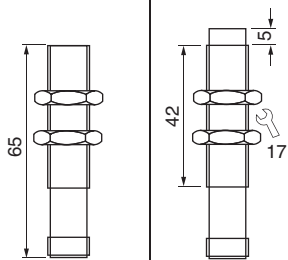
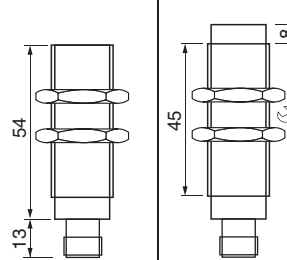
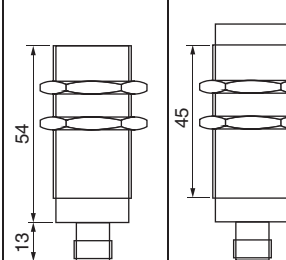
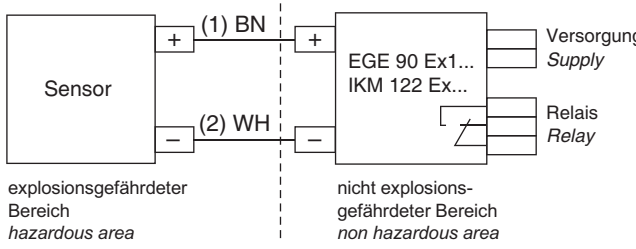

Design	M12x1		M18x1		M30x1.5	
Dimensions						
Installation flush (f) non flush (nf)	f, nf		f, nf		f, nf	
Operating distance [mm]	2 f, 4 nf		5 f, 8 nf		10 f, 15 nf	
ID-No.	P31196	P31197	P31198	P31199	P31200	P31201
Type	IGEXU 02	IGEXU 04	IGEXU 05	IGEXU 08	IGEXU 10	IGEXU 15
Ambient temperature [°C]	-25...+60 (Zone 0) -25...+75 (Zone 1 / 2 / 20 / 22) Ex-Sensors for higher ambient temperatures on request					
Ex marking	II 1D Ex ma IIIC T100 °C Da IP 67 / II 1G Ex ia IIC T6 Ga					
Certificate No.	TÜV 03 ATEX 2036					
Ambient temperatures for temperature classes [°C]	T6 : 75 T5 : 90					
Maximum values	Ci = 22.0 nF Li = 3.0 mH Ii = 15.9 mA Ui = 12.6 V Pi = 50.0 mW					
Only for the connection to certified intrinsically safe circuits with the following maximum values						
Housing material	Br-Ni / PA					
Protection [EN 60529]	IP 67					
Connection	M12 connector					
For the connection to amplifiers EGE 90 Ex1... or IKM 122 Ex...	 <p>explosionsgefährdeter Bereich / hazardous area</p> <p>nicht explosionsgefährdeter Bereich / non hazardous area</p>					
Accessories	connecting cable SLG 3-2 (Z01076), plug-lock type PL-M12 (Z01182), page 3.65					

Dust / Gas - Ex Intrinsically safe • Zone 0/20

Series IGEX - Proximity switches

Category 1

Dust Ex Zone 20

Gas Ex Zone 0

NAMUR (EN 60947-5-6)



Design	M12x1		M18x1		M30x1.5	
Dimensions						
Installation flush (f) non flush (nf)						
Operating distance [mm]	2 f	4 nf	5 f	8 nf	10 f	15 nf
ID-NO.	P31151	P31152	P31153	P31154	P31155	P31156
Type	IGEX 02	IGEX 04	IGEX 05	IGEX 08	IGEX 10	IGEX 15
Ambient temperature [°C]	-25...+60 (Zone 0) -25...+75 (Zone 1 / 2 / 20 / 22) Ex-sensors for higher ambient temperatures on request					
Ex marking	II 1D Ex ma IIIC T100 °C Da IP 67 / II 1G Ex ia IIC T6 Ga					
Certificate No.	TÜV 03 ATEX 2036					
Ambient temperatures for temperature classes [°C]	T6 : 75 T5 : 90					
Maximum values	Ci = 22.0 nF Li = 3.0 mH Ii = 15.9 mA Ui = 12.6 V Pi = 50.0 mW					
Only for the connection to certified intrinsically safe circuits with the following maximum values:						
Housing material	Br-Ni / PA					
Protection [EN 60529]	IP 67					
Connection	2 m PVC-cable 2x0.5 mm ²					
For the connection to amplifiers EGE 90 Ex1... or IKM 122 Ex...	<p>explosionsgefährdeter Bereich hazardous area</p> <p>nicht explosionsgefährdeter Bereich non hazardous area</p>					

Dust - Ex Compact model • Zone 22

Series IGEX22 - Proximity switches







Category 3

Dust Ex Zone 22

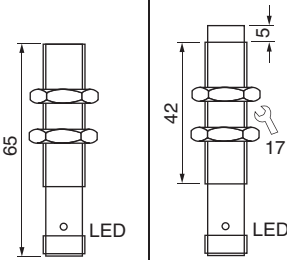
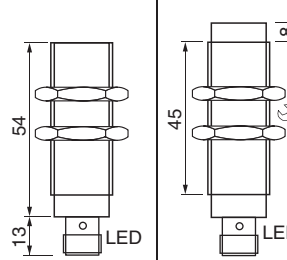
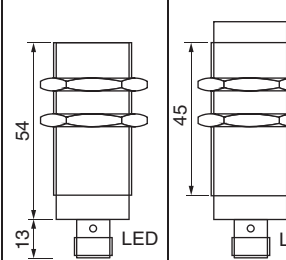
DC 24 V

PNP switching output

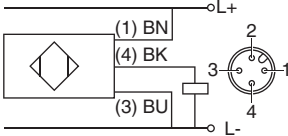

Design	DC PNP • M12x1		DC PNP • M18x1		DC PNP • M30x1.5	
Dimensions						
Installation flush (f) non flush (nf)						
Operating distance [mm]	2 f	4 nf	5 f	8 nf	10 f	15 nf
Switching output PNP						
ID-No.	P31187	P31188	P31189	P31190	P31191	P31192
Type	IGEX22 02 GSPU	IGEX22 04 GSPU	IGEX22 05 GSPU	IGEX22 08 GSPU	IGEX22 10 GSPU	IGEX22 15 GSPU
Ex marking	II 3D Ex mc IIIC T 80°C Dc IP 67 X					
Supply voltage [V]	10...30 DC					
Switching current [mA]	200					
Short circuit proof	•					
Overcurrent release [mA]	250					
Reverse protection	•					
Voltage drop max. [V]	2					
Residual current [mA]	-					
Current consumption [mA]	7					
Switching frequency [Hz]	500					
Ambient temperature [°C]	-25...+70					
EMC-class	A					
Protection [EN 60529]	IP 67					
LED display	•					
Housing material	Br-Ni / PBT					
Connection	M12 connector					
Note: Do not use in the presence of conductive dusts						
Accessories	connection cable SLG 3-2 (Z01076), plug-lock type PL-M12 (Z01182), page 3.65					

Dust - Compact model • Zone 22

Series IGEX22 - Proximity switches

Category 3
Dust Zone 22

DC 24 V
PNP switching output



Design	DC PNP • M12x1		DC PNP • M18x1		DC PNP • M30x1.5	
Dimensions						
Installation flush (f) non flush (nf)						
Operating distance [mm]	2 f	4 nf	5 f	8 nf	10 f	15 nf
Output PNP						
ID-No.	P31165	P31166	P31167	P31168	P31169	P31170
Type	IGEX22 02 GSP	IGEX22 04 GSP	IGEX22 05 GSP	IGEX22 08 GSP	IGEX22 10 GSP	IGEX22 15 GSP
Ex marking	II 3D Ex mc IIIC T 80 °C Dc IP 67 X					
Supply voltage [V]	10...30 DC					
Switching current [mA]	200					
Short circuit proof	•					
Overcurrent release [mA]	250					
Reverse protection	•					
Voltage drop max. [V]	2					
Residual current [mA]	-					
Current consumption [mA]	7					
Switching frequency [Hz]	500					
Ambient temperature [°C]	-25...+70					
EMC-class	A					
Protection [EN 60529]	IP 67					
LED display	•					
Housing material	Br-Ni / PBT					
Connection	2 m PVC-cable 3x0.34 mm ²					
Note: Do not use in the presence of conductive dusts						

Dust- Ex Compact model • Zone 22

Series IGVE X22 - Proximity switches

Stainless steel

Category 3
Dust Ex Zone 22

DC 24 V
PNP switching output



Design	DC PNP • M12x1	DC PNP • M18x1	DC PNP • M30x1,5
Dimensions			
Operating distance [mm]	2	5	10
Switching output PNP			
ID-No.	P31285	P31286	P31287
Type	IGVE X22 02 GSPU	IGVE X22 05 GSPU	IGVE X22 10 GSPU
Ex marking	II 3D Ex mc IIIC T 95°C Dc IP 67 X		
Supply voltage [V]	10...30 DC		
Switching current [mA]	200		
Short circuit proof	•		
Reverse protection	•		
Voltage drop max. [V]	1,5		
Current consumption [mA]	12		
Switching frequency [Hz]	180		
Ambient temperature [°C]	-25...+70		
EMC class	A		
Protection [EN 60529]	IP 67		
LED display	•		
Housing material	AISI 316 L		
Connection	M12 connector		
Accessories	connection cable SLG 3-2 (Z01076), plug-lock type PL-M12 (Z01182), page 3.65		

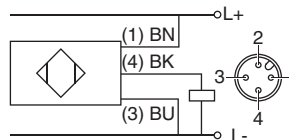

Dust - Compact model • Zone 20

Series IDEX20 - Proximity switches

Category 1

Dust Zone 20

DC 24 V

PNP switching output



Design	DC PNP • Ø80 mm	DC PNP • Ø100 mm	DC PNP • Ø160 mm
Dimensions			
Installation non flush (nf)	Pot LED	Pot LED	Pot LED
Operating distance [mm] (Adjustable range)	55 nf (10...80)	70 nf (10...110)	120 nf (20...150)
Switching output PNP			
ID-No.	P31182	P31183	P31184
Type	IDEX20 080 GSP	IDEX20 100 GSP	IDEX20 160 GSP
Ex marking	II 1D Ex ma IIIC T 80 °C Da IP 67		
Certificate No.	TÜV 05 ATEX 2845 X		
Supply voltage [V]	10...30 DC		
Switching current [mA]	100		
Short circuit proof	•		
Reverse protection	•		
Voltage drop max. [V]	2		
Residual current [mA]	-		
Current consumption [mA]	7		
Switching frequency [Hz]	20		
Ambient temperature [°C]	-25...+70		
EMC-class	A		
Protection [EN 60529]	IP 67		
LED display	•		
Housing material	PA	PA / Aluminium	PA / Aluminium
Connection	2 m PVC-cable 3x0.5 mm ²		
Accessories	housing for screw terminals series GK...		

Series IDEX - Proximity switches

Category 1

Dust Ex Zone 20

Gas Ex Zone 0

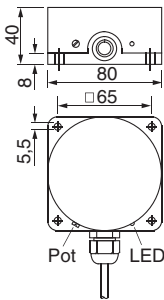
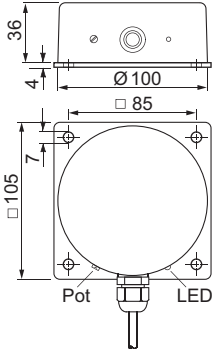
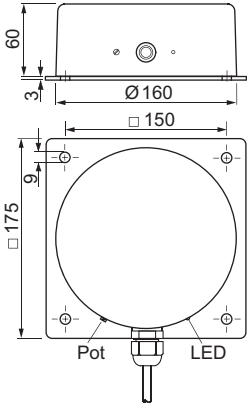
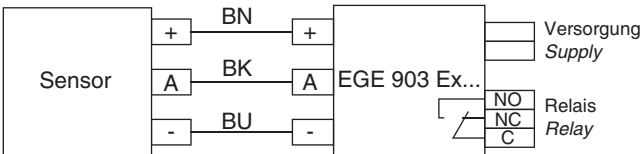

Design	Ø80 mm	Ø100 mm	Ø160 mm
Dimensions			
Installation non flush (nf)	Pot LED	Pot LED	Pot LED
Operating distance [mm] (Adjustable range)	55 nf (10...70)	70 nf (10...100)	120 nf (20...150)
ID-No.	P31157	P31158	P31159
Type	IDEX 080	IDEX 100	IDEX 160
Ambient temperature [°C]	-25...+75		
Ex marking	Ex-Sensors for higher ambient temperatures on request		
Certificate No.	II 1D Ex ma IIIC T100 °C Da IP 67 / II 1G Ex ia IIC T6 Ga		
Ambient temperatures for temperature classes [°C]	T6 : 75 T5 : 90		
Maximum values	Ci = 120 nF Li = negligibly small Ii = 80 mA Ui = 12.6 V Pi = 252 mW		
Only for the connection to certified intrinsically safe circuits with the following maximum values:			
Housing material	PA / Aluminium		
Protection [EN 60529]	IP 67		
Connection	2 m PVC-cable 3x0.5 mm ²		
For the connection to amplifiers EGE 903 Ex...			

Dust - Compact model • Zone 22

Series IDEX22 - Proximity switches

Category 3

Dust Zone 22

DC 24 V

PNP switching output



Design	DC PNP • Ø80 mm	DC PNP • Ø105 mm	DC PNP • Ø160 mm
Dimensions			
Installation non flush (nf)			
Operating distance [mm] (Adjustable range)	55 nf (10...80)	100 nf (10...110)	120 nf (20...150)
Switching output PNP			
ID-No.	P31329	P31330	P31331
Type	IDEX22 080 GSPU	IDEX22 105 GSPU	IDEX22 160 GSPU
Ex marking	II 3D Ex mc IIIC T 80 °C Dc IP 67 X		
Supply voltage [V]	10...30 DC		
Switching current [mA]	200		
Short circuit proof	•		
Overcurrent release [mA]	450		
Reverse protection	•		
Voltage drop max. [V]	2		
Residual current [mA]	-		
Current consumption [mA]	7		
Switching frequency [Hz]	20		
Ambient temperature [°C]	-20...+70		
EMC-class	A		
Protection [EN 60529]	IP 67		
LED display	•		
Housing material	PBT	PBT	PBT / Aluminium
Connection	M12 connector	M12 connector	M12 connector
Note: Do not use in the presence of conductive dusts.			

Ex - Amplifiers

Series EGE 90 Ex

Dust

Gas

Cable break and short circuit monitoring

Connection to intrinsically safe 2-lead sensors



Design	EGE 90 Ex...		
Dimensions			
ID-No.	P30340	P30341	P31035
Type	EGE 90 Ex1-230	EGE 90 Ex1-115	EGE 90 Ex1-24
Supply voltage [V]	230 AC +15/-10%	115 AC +15/-10%	24 DC ±15%
Certificate No.	TÜV 97 ATEX 1148		
Ex marking	II (1)D [Ex ia Da] IIIC / II (1)G [Ex ia Ga] IIC		
Maximum values	$U_o = 12.6 \text{ V}$ $I_o = 15.9 \text{ mA}$ $P_o = 50 \text{ mW}$ $C_o = 1.15 \text{ }\mu\text{F}$ $L_o = 120 \text{ mH}$		
Output	relay / change-over		
Switching voltage max. [V]	250 AC / 24 DC		
Switching current max. [A]	4 AC / 4 DC		
Switching power	$\cos \varphi > 0,7 / L/R < 200 \text{ ms}$		
Ambient temperature [°C]	-20...+60		
Protection [EN 60529]	IP 20		
Connection	terminal screws		
Notes:	<p>The installation of the amplifier has to be executed outside of the hazardous area.</p> <p>The amplifier is also suited for connection of NAMUR sensors.</p>		

- Amplifiers

Series EGE 903 Ex

Dust

Gas

Cable break and short circuit monitoring

Connection to intrinsically safe 3-lead sensors



Design	EGE 903 Ex...		
Dimensions			
ID-No.	P21141	P21142	P21143
Type	EGE 903 Ex-230	EGE 903 Ex-115	EGE 903 Ex-24
Supply voltage [V]	230 AC +15/-10%	115 AC +15/-10%	24 VDC ±15%
Certificate no.	TÜV 01 ATEX 1663		
Ex marking	II (1)D [Ex ia Da] IIIC / II (1)G [Ex ia Ga] IIC		
Maximum values	$U_o = 12.6 \text{ V}$ $I_o = 80 \text{ mA}$ $P_o = 252 \text{ mW}$ $C_o = 270 \text{ nF}$ $L_o = 5.4 \text{ mH}$		
Output	relay / change-over		
Switching voltage max. [V]	250 AC / 24 DC		
Switching current max. [A]	4 AC / 4 DC		
Switching power	$\cos \varphi > 0,7 / L/R < 200 \text{ ms}$		
Ambient temperature [°C]	-20...+60		
Protection [EN 60529]	IP 20		
Connection	terminal screws		
Note:	<p>The installation of the amplifier has to be executed outside of the hazardous area.</p>		

Ex - Amplifiers

Series IKM

Dust

Gas

Cable break and short circuit monitoring

Connection to intrinsically safe 2-lead sensors

Output function programmable



Design	IKM 122 Ex-230
Dimensions	
ID-No.	P31332
Type	IKM 122 Ex-230
Supply voltage [V]	230 AC $\pm 10\%$
Certificate No.	TÜV 11 ATEX 556280
Ex marking	II (1)G [Ex ia Ga] IIC / II (1)D [Ex ia Da] IIIC
Maximum values	$U_o = 9.6 \text{ V}$ $I_o = 12.1 \text{ mA}$ $P_o = 29 \text{ mW}$ $C_o = 0.83 \text{ }\mu\text{F}$ $L_o = 5.00 \text{ mH}$
Output	relay / change-over
Switching voltage max. [V]	250 AC 24 DC
Switching current max. [A]	4 AC 4 DC
Switching power	$\cos \varphi \geq 0,7$ L/B $\leq 200 \text{ ms}$
Ambient temperature [°C]	-20...+60
Special function	cable break monitoring
Protection [EN 60529]	terminals: IP 20 / housing: IP 40
Connection	terminal screws
Note: The installation of the amplifier has to be executed outside of the hazardous area.	

Accessories • M12 connector

System SL

Finished cable plug housing
Self locking screw plug
Protection IP 67

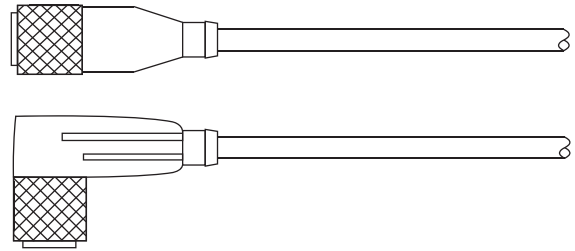

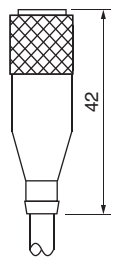
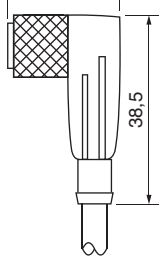
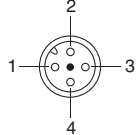
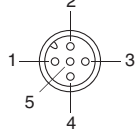
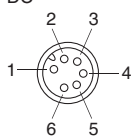
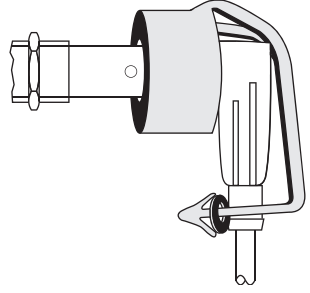
Cable plug housing	Pin-assignment	Plug-lock
<div style="display: flex; justify-content: space-around;"> <div style="text-align: center;"> <p>straight</p>  <p>42</p> <p>SLG...</p> </div> <div style="text-align: center;"> <p>angular</p>  <p>26,5</p> <p>38,5</p> <p>SLW...</p> </div> </div>	<div style="display: flex; justify-content: space-around;"> <div style="text-align: center;"> <p>DC</p>  <p>3-wire 1: BN 2: - 3: BU 4: BK</p> </div> <div style="text-align: center;"> <p>DC</p>  <p>4-wire 1: BN 2: WH 3: BU 4: BK</p> </div> </div> <div style="text-align: center; margin-top: 10px;"> <p>DC</p>  <p>6-wire 1: BN 2: WH 3: BU 4: BK 5: GY 6: PK</p> </div>	 <p>PL-M12</p>

TYPE	ID-NO.	DESIGN
SLG 3-2	Z01076	Cable plug housing straight, 2 m cable 3x0.34 mm ² max. 250 V / 4 A
SLG 3-5	Z01077	Cable plug housing straight, 5 m cable 3x0.34 mm ² max. 250 V / 4 A
SLW 3-2	Z01078	Cable plug housing angular, 2 m cable 3x0.34 mm ² max. 250 V / 4 A
SLW 3-5	Z01079	Cable plug housing angular, 5 m cable 3x0.34 mm ² max. 250 V / 4 A
SLW 3-2-LED	Z00052	Cable plug housing angular, 2 m cable 3x0.34 mm ² max. 250 V / 4 A PNP with LED
SLG 4-2	Z00445	Cable plug housing straight, 2 m cable 4x0.25 mm ² max. 250 V / 4 A
SLG 4-5	Z00449	Cable plug housing straight, 5 m cable 4x0.25 mm ² max. 250 V / 4 A
SLW 4-2	Z00446	Cable plug housing angular, 2 m cable 4x0.25 mm ² max. 250 V / 4 A
SLW 4-5	Z00450	Cable plug housing angular, 5 m cable 4x0.25 mm ² max. 250 V / 4 A
SLW 4-2-LED	Z01157	Cable plug housing angular, 2 m cable 4x0.25 mm ² max. 250 V / 4 A PNP with LED
SLG 5-2	Z01150	Cable plug housing straight, 2 m cable 5x0.34 mm ² max. 60 V / 2 A
SLW 5-2	Z01151	Cable plug housing angular, 2 m cable 5x0.34 mm ² max. 60 V / 2 A
SLG 6-2	Z01197	Cable plug housing straight, 2 m cable 6x0.25 mm ² max. 36 V / 2 A
SLW 6-2	Z01198	Cable plug housing angular, 2 m cable 6x0.25 mm ² max. 36 V / 2 A
PL-M12	Z01182	Plug-lock for sensors in Ex areas

DATA

Thread	M12x1	Contact resistance	≤ 5 mΩ
Material	PVC	Insulation resistance	>10 ⁹
Protection	IP 67	Testing voltage	2.0 KV eff. / 5 and 6 pol. 1.5 KV eff.
Temperature range	-25...+80 °C		

Note

Sensors with NC output are connected to 4 pole cable plug housings. In this case, the break output is connected to the white lead (connection 2).

Accessories • PG plug system

PG plug system

PG plug type connection with PVC-cable Protection IP 68

PG-plug connection

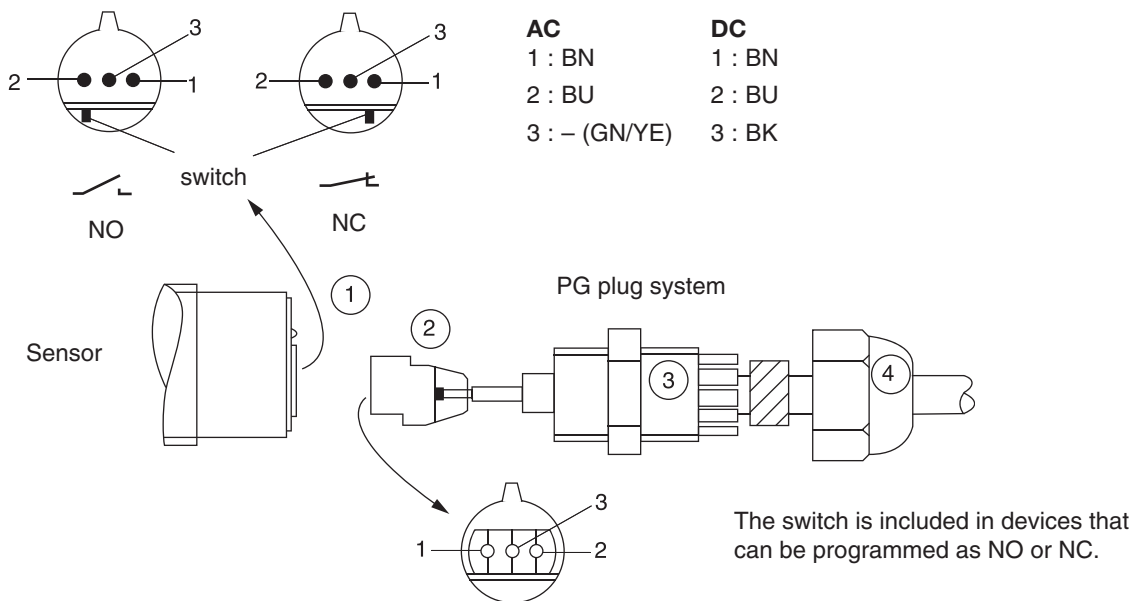

Mounting of PG plug system

Connect the cable to the EGE-plug (2) and put it into the plug-housing (1) until it is at the stop. Make sure that the "nose" of the plug fits exactly into the housing. If this is done in the right way, the plug is hidden in the plug-housing.

Screw part (3) into the plug-housing (1) and fix it rightly with a spanner. After about 2 hours tighten it again with the spanner.

Now fit the nut (4) by hand and afterwards with a spanner. Do not apply too much force. For a good sealing there should be stet 2 mm between nut (4) and part (3).

TYPE	ID-NO.	DESIGN
PG 2-2	Z00025	PG-plug connection, 2 m PVC-cable 2x0.75 mm ² AC
PG 2-3	Z00026	PG-plug connection, 3 m PVC-cable 2x0.75 mm ² AC
PG 2-5	Z00027	PG-plug connection, 5 m PVC-cable 2x0.75 mm ² AC
PG 2-10	Z00028	PG-plug connection, 10 m PVC-cable 2x0.75 mm ² AC
PG 2-20	Z00029	PG-plug connection, 20 m PVC-cable 2x0.75 mm ² AC
PG 3-2	Z00020	PG-plug connection, 2 m PVC-cable 3x0.5 mm ² DC
PG 3-3	Z00021	PG-plug connection, 3 m PVC-cable 3x0.5 mm ² DC
PG 3-5	Z00022	PG-plug connection, 5 m PVC-cable 3x0.5 mm ² DC
PG 3-10	Z00023	PG-plug connection, 10 m PVC-cable 3x0.5 mm ² DC
PG 3-20	Z00024	PG-plug connection, 20 m PVC-cable 3x0.5 mm ² DC

Note

The power supply must be disconnected before the plug will be installed or removed.

Code: BK = black BN = brown BU = blue GN = green YE = yellow GY = grey PK = pink WH = white

Accessories • Assembly parts

Lock nuts, brass-nickel - plated

ID-NO.	Z00106	Z00107	Z00114	Z00109	Z00110
Nut thickness [mm]	4	4	4	5	5
Thread	M12x1	M18x1	M22x1	M30x1.5	M38x1.5
Spanner size	17	24	27	36	50

Lock nuts, special steel

ID-NO.	Z01098	Z00112	Z00113	Z00115
Nut thickness [mm]	4	4	4	5
Thread	M8x1	M12x1	M18x1	M30x1.5
Spanner size	13	17	24	36

Lock nuts, plastics

ID-NO.	Z00180	Z00120	Z00117	Z00118	Z00119	Z01092	Z01052
Nut thickness [mm]	6	8	4	5	5,5	8	8
Thread	M14x1	M30x1.5	M12x1	M18x1	M30x1.5	G3/4	G1
Spanner size	22	41	17	24	36	41	50
Material	PTFE	PTFE	PPE	PPE	PPE	PTFE	PTFE

Central screw, polyamide

Z00104 M12, length 70 mm, hexagon socket 10 mm, material PA

Z00105 M16, length 90 mm, hexagon socket 14 mm, material PA

MOUNTING CLAMPS

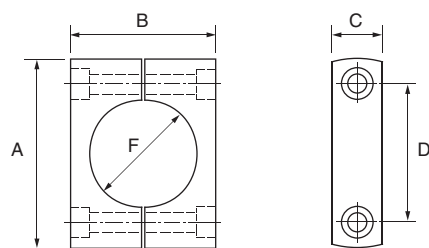
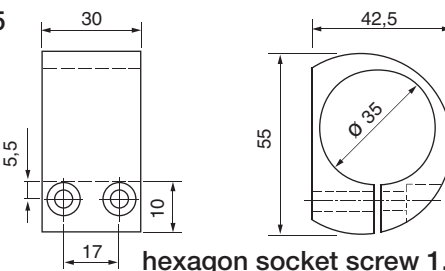
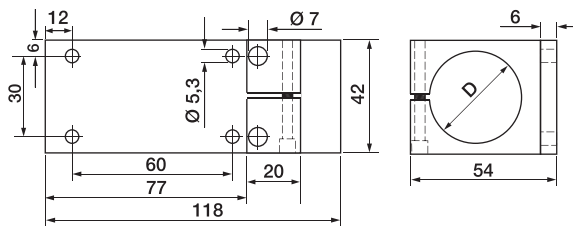
TYPE	ID-NO.	DIMENSIONS	DESIGN																			
KLS 20 KLS 34	Ø 20 Ø 34	Z00100 Z00102	 <p>E: hexagon socket screw 1.4305</p>	Clamps of PA, for smooth-bodied switches <table border="1"> <thead> <tr> <th>F</th> <th>Ø 20</th> <th>Ø 34</th> </tr> </thead> <tbody> <tr> <td>A</td> <td>47</td> <td>61</td> </tr> <tr> <td>B</td> <td>30</td> <td>47</td> </tr> <tr> <td>C</td> <td>17</td> <td>15</td> </tr> <tr> <td>D</td> <td>32</td> <td>45</td> </tr> <tr> <td>E</td> <td>M5x30</td> <td>M5x50</td> </tr> </tbody> </table>	F	Ø 20	Ø 34	A	47	61	B	30	47	C	17	15	D	32	45	E	M5x30	M5x50
F	Ø 20	Ø 34																				
A	47	61																				
B	30	47																				
C	17	15																				
D	32	45																				
E	M5x30	M5x50																				
KLB 35	Ø 35	Z00125	 <p>hexagon socket screw 1.4571</p>	Clamp of PTFE (Teflon), for smooth-bodied switches hexagon socket screw M5x40																		
KBM 025 KBM 030 KBM 035	Ø 25 Ø 30 Ø 35	Z01189 Z01188 Z01187		Mounting clamp of Aluminium <table border="1"> <thead> <tr> <th>Type</th> <th>D</th> </tr> </thead> <tbody> <tr> <td>KBM 025</td> <td>Ø 25</td> </tr> <tr> <td>KBM 030</td> <td>Ø 30</td> </tr> <tr> <td>KBM 035</td> <td>Ø 35</td> </tr> </tbody> </table>	Type	D	KBM 025	Ø 25	KBM 030	Ø 30	KBM 035	Ø 35										
Type	D																					
KBM 025	Ø 25																					
KBM 030	Ø 30																					
KBM 035	Ø 35																					



Headquarters
EGE-Elektronik
Spezial-Sensoren GmbH

Ravensberg 34
D-24214 Gettorf
Tel. +49 (0) 4346 / 41580
Fax +49 (0) 4346 / 5658

Internet: www.ege-elektronik.com



EGE-Elektronik ApS
Forstallé 79
DK-6200 Aabenraa
Tel. +45 70207271
Fax +45 70207272



EGE-Specialsensorer AB
Box 137
S-51223 Svenljunga
Tel. +46 32512060
Fax +46 32512064



Stork AS
Brynsveien 100
N-1352 Kolsås
Tel. +47 67176400
Fax +47 67176401



Vision Systems OY
PL353
FI-40101 Jyväskylä
Tel. +358 (0)10 322 7100
Fax +358 (0)10 322 7119



Molex France
18 Parc Burospace
F-91571 Bièvres Cedex
Tel. +33 2 32 96 04 28
Fax +33 2 32 96 04 21



Cematic-Electric B.V.
Postbus 777
NL-7550 AT Hengelo
Tel. +31 742433422
Fax +31 742913333



ICM Ital Control Meters Srl
Via della Valle 67
I-20048 Carate Brianza (Mi)
Tel. +39 0362 8052 00
Fax +39 0362 8052 01



Bibus Spain, S. L.
Rúa do Arroncal, Vial C – Nave 4A
ES-36350 Nigran
Tel. +34 986 247286
Fax +34 986 209247



Powelectrics Limited
Sandy Hill Park, Sandy Way
Amington, Tamworth
GB-Staffordshire B77 4DU
Tel. +44 1827310666
Fax +44 1827310999



Bachofen AG
Ackerstraße 42
CH-8610 Uster
Tel. +41 449441111
Fax +41 449441233



VWR International GmbH
Graumanngasse 7
A-1150 Wien
Tel. +43 1 97 002 - 0
Fax +43 1 97 002 - 600



Countapulse Controls (PTY) LTD.
P.O.B. 40393
ZA-2022 Cleveland
Tel. +27 116157556
Fax +27 116157513



HITECH Ltd.
1-35-2 Simouma, Setagaya,
JPN-Tokyo 154-0002
Tel. +81 35430 2301
Fax +81 35430 2302



Micromax S&A P/L
Unit 2 106-110 Beaconsfield Street
AUS-Silverwater NSW 2128
Tel. +61 1300 362626
Fax +61 1300 017100



Protek Teknik Elektrik Ticaret ve Sanayi Ltd. Sti.
Okçumusa Cad. Kismet Han 94/2
TR-80020 Karaköy/Istanbul
Tel. +90 2122377982
Fax +90 2122354609



IAC & Associates
2180 Fasan Drive
Oldcastle
CDN-Ontario N0R 1L0
Tel. +1 519 7370311
Fax +1 519 7370314
TF +1 800 711 1900



Yuden-Tech Co., Ltd.
5F., No. 121, Lide St.,
Zhonghe City, Taipei County 235,
Taiwan (R.O.C.)
Tel. +886 2 8221 2958
Fax +886 2 8221 2492



Shanghai Beishidietian Business Trade Co., Ltd.
4F, No. 88-1, Lane 7039,
Zhongchun Rd., Minhang Area
Shanghai City
Tel. +86 21 54887307
Fax +86 21 54887305



CSE-W. Arthur Fischer Ltd.
15 Polaris Place, Greenmount
NZ-East Tamaki, Auckland
Tel. +64 9271 3810
Fax +64 9265 1362



Kolektor Synatec d.o.o.
Vojkova ul. 8b,
PO Box 57
SI-5280 Idrija
Tel. +386 5 3720650
Fax +386 5 3720660



Introl Sp. z o.o.
ul. Kościuszki 112
40-519 Katowice
Tel. +48 32 789 00 00
Fax +48 32 205 33 77



Bibus Portugal, LDA
Centro Empresarial AAA
Rua Ponte da Pedra, 240 - C4
4470-108 Gueifães - Maia
Porto
Tel. +351 22 906 50 50
Fax +351 22 906 50 53



Futron Electronics PTE Ltd.
1004 Toa Payoh North
#04-08/09/10
Singapore 318995
Tel. +65 6250 2456
Fax +65 6250 6592



Useong Electrade Co.,
D-1006, Technopark
No. 1345, Soha-dong, Gwangmyeong-si
Gyeonggi-do,
Korea
Tel. +82 (0) 2 2686 7314
Fax +82 (0) 2 2686 7316