

## Price

High-efficiency with Low Price

While achieving a significant improvement in motor performance, driver operations and functions, compared to conventional products, the **RKII** Series has a new, low price.

## Space Saving

Slim and Compact

This new driver has been created by re-arranging the internal components, optimizing the usage of the size within the driver. In addition, drivers can be installed side by side, reducing a significant amount of space.

- When drivers are installed in contact with each other, the allowable ambient temperature range is 0 to 40°C

Slim & compact driver

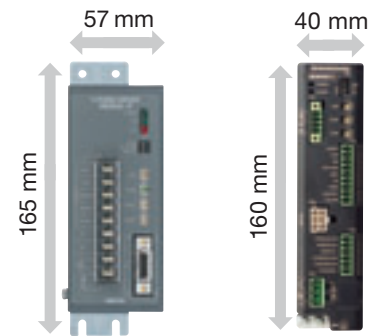

Conventional Model  
**RK** Series Driver

**RKII** Series Driver

Installation Area  
**9405 mm<sup>2</sup>**  
(165x57=9405)

Installation Area  
**6400 mm<sup>2</sup>**  
(160x40=6400)



Conventional Model:  
**RK** Series  
□ 60 mm Standard Type

**RKII** Series  
Pulse Input Type  
□ 60 mm Standard Type

- For price and lead time, please contact the nearest Oriental Motor office, or visit the Oriental Motor website.

Multiple units can be installed in coherently with each other.

Conventional Model:  
**RK** Series Driver

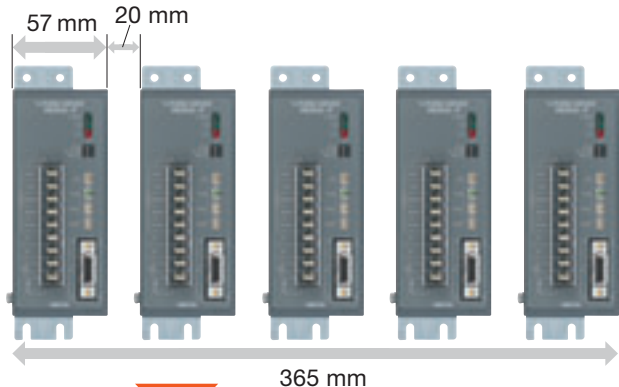

**RKII** Series Driver

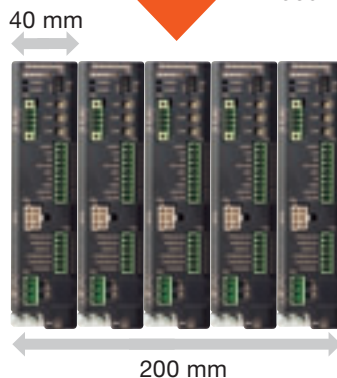

Installation Width  
**45% Reduction**

ADVANTAGE  
**High-efficiency and compact size, yet cost down.**

ADVANTAGE  
**Less space and costs for control board.**

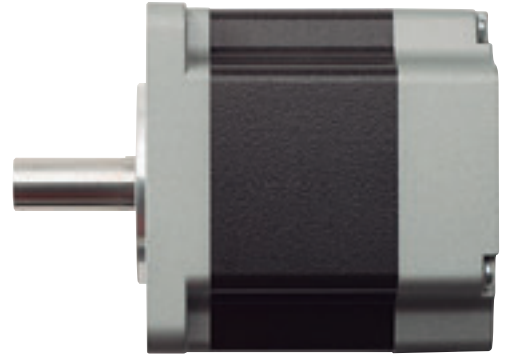

# High Efficiency

Reduces power consumption by up to 47%

By optimizing the motor material, 47% of the power consumption has been reduced. This results in the decrease of electricity and CO<sub>2</sub> emission. In addition, with lower heat generated by the motor, there is a lesser requirement of fans or radiation plate.

# Lower Heat Generation

Continuous Operation is Achieved

By utilizing high-efficient technology, continuous operation is achieved due to the reduction of motor heat.

### ● Power Consumption Comparison

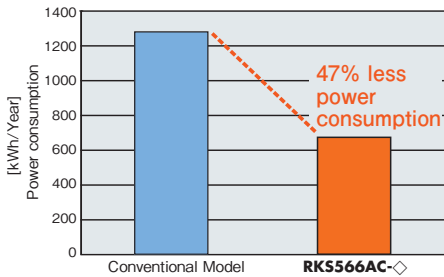

Operating Condition  
 · Spin speed : 1000 r/min  
 · Load torque: 0.47 N·m  
 · Operating time: 24 hours (Operation 70%, Stand-by 25%, Stop 5%) 365 days/year

### ● Motor Surface Temperature Comparison under the Same Conditions

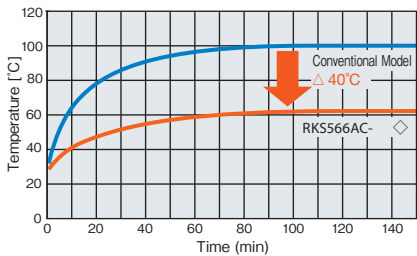

### ● Power Consumption Comparison

Items	Conventional Model	RKS566AC-◇	Comparison	
			Value	Change
Power consumption during operation [W]	204	106	98 W	Reduced by 48%
Power consumption during stand-by [W]	14	13	1 W	Reduced by 7%
Power consumption [kWh/year]	1281	678	603 kWh/year	Reduced by 47%
CO <sub>2</sub> emission equivalent to power consumption ※ [kg/year]	533	282	251 kg/year	Reduced by 47%

※ : Conversion rate: 0.416 kg/kWh

### ● Distribution of temperature (shown on thermography)

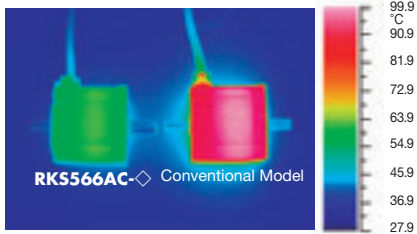

**ADVANTAGE**  
 With the maximized motor performance, it is easy to achieve high efficiency and cost savings.

**ADVANTAGE**  
 Less effort for temperature control.

# EASY

CONNECTION & SYSTEM

Easy to wire, easy to select.

## Wiring

### Easy Wiring

The new I/O connector does not require a screw, eliminating the need for soldering or a special crimping tool. The motor connector can be connected easily by using a dedicated cable. This will reduce wiring time, maintenance and prevent mis-wiring.

#### ● Motor Connector Wiring

- No screw tightening

- Wiring time reduction
- Reduce problems caused by mis-wiring

#### ● I/O Connector Wiring

- No soldering
- No crimping tools

- Wiring time reduction
- Less maintenance

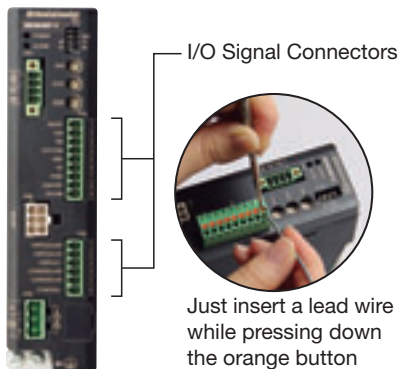

Just insert a lead wire while pressing down the orange button with a screwdriver or pointed object.

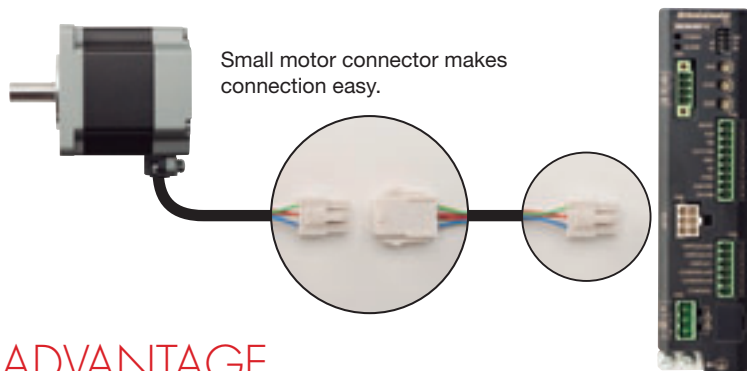

## Selection

### Easy Selection

#### ● Free Motor Selection Service for Customers:

Send us a motor selection inquiry via our website, fax or e-mail.

## ADVANTAGE

**The redesigned driver is more compact and allows an installation close to other drivers. The wiring has been simplified.**

Two types of drivers are available.

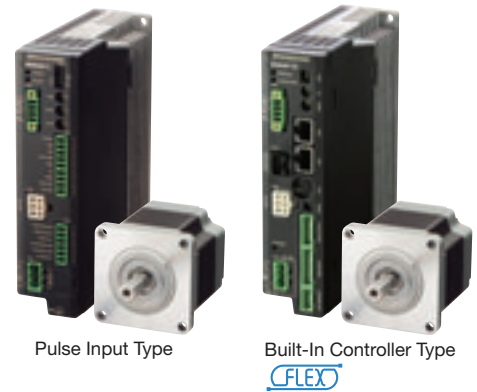

# Driver

Pulse Input Type  
Built-In Controller Type

Select the control method in accordance with your operation system.

## Pulse Input Type

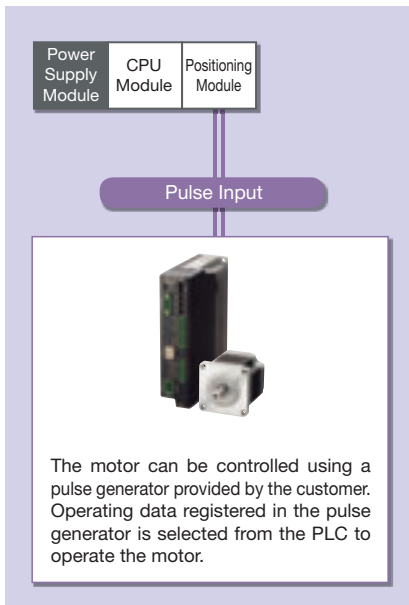

## Built-In Controller Type **FLEX**

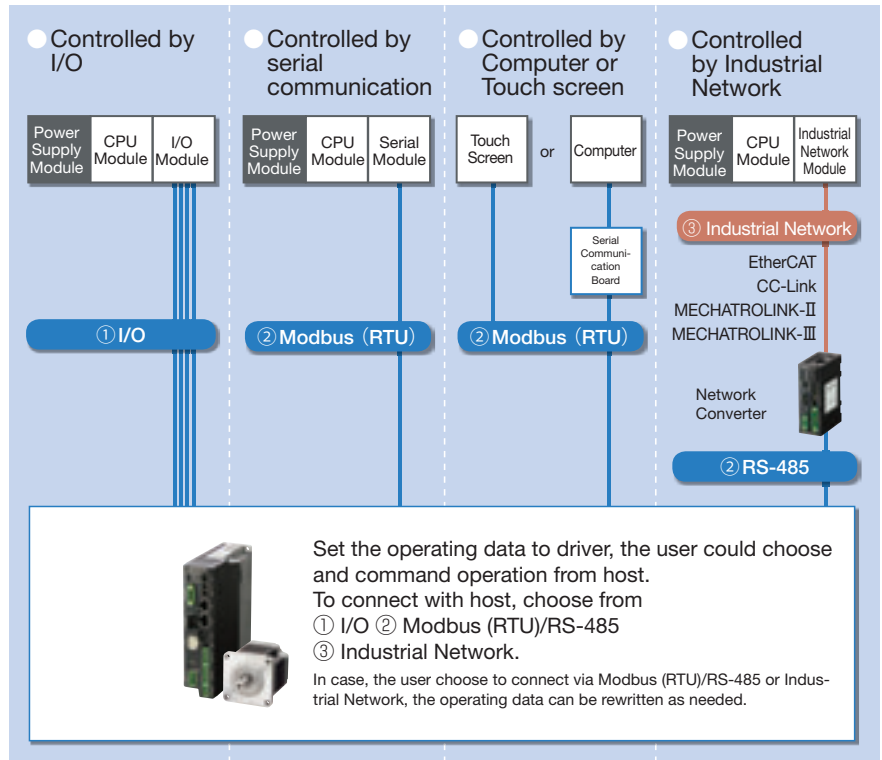

### How to connect (Example: Refer to P. 8 and P. 9)

**① I/O**

The function of a built-in pulse generator lets you build an operation system by connecting directly to a PLC. Since no separate pulse generator is required, the drivers of this type save space and simplify systems.

**② Modbus (RTU)/RS-485**

Through RS-485 communication, you can set operating data and parameters and input operation commands. A maximum of 31 drivers can be connected to one serial unit. There is also a function for simultaneously starting multiple axes. The unit also has a feature for starting multiple axes simultaneously. The unit supports the Modbus (RTU) protocol, which makes it easy to connect a PLC or similar device to the driver.

**③ Industrial Network**

By using a Network Converter (sold separately), you can use EtherCAT communication, CC-Link communication and MECHATROLINK communication. Over these links, operating data and parameters can be set, and operation commands can be sent to the driver.

### Built-In Controller (Stored Data) Type

The burden on the programmable PLC is reduced because the information necessary for motor operations is built into the driver. This simplifies the system configuration for multi-axis control. Set with control module (sold separately), data setting software or RS-485 communication.

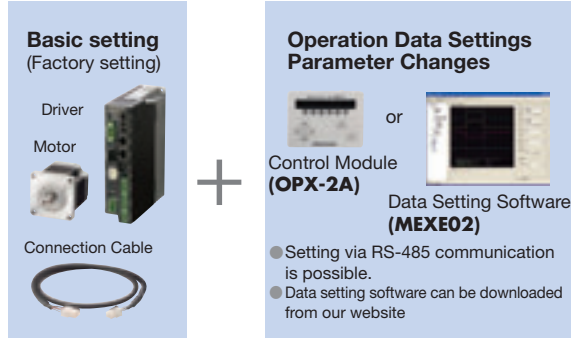

**ADVANTAGE**  
**Connects to a Wide Variety of Host Systems.**

# EASY

## CONNECTION & NETWORK

Built-In Controller Type compatible with FLEX.

Example of connection and control with the Built-In Controller Type **FLEX**.

### I/O Control

#### Using a Switch Box

Operating data is set in the driver and the motor can be started or stopped simply by connecting a switch you have on hand. Control can be performed easily without using a PLC.

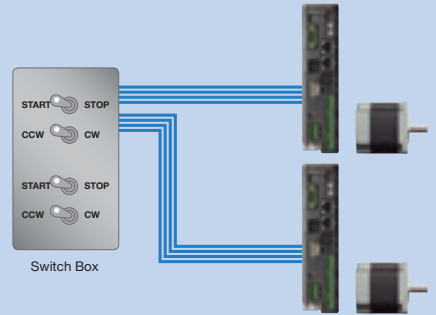

Simple Control

Low Cost

#### Using PLC (No positioning control module is required)

When using PLC, you can built an operation system by connecting directly to an I/O Unit. A positioning unit is not necessary on the PLC side therefore space is saved and the system is simplified

Example: System requires positioning control module

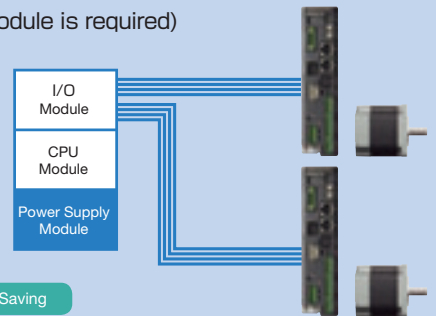
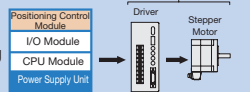

Simple Control

Low Cost

Space Saving

#### Using PLC and a Touch Screen

Normally, the motor is started and stopped with I/O. Changing the operating data settings and displaying the monitors and alarms is performed with the touch panel using Modbus (RTU) communication. When there is a lot of setup work, changes can be easily performed on the touch screen, and the burden of creating ladders is reduced.

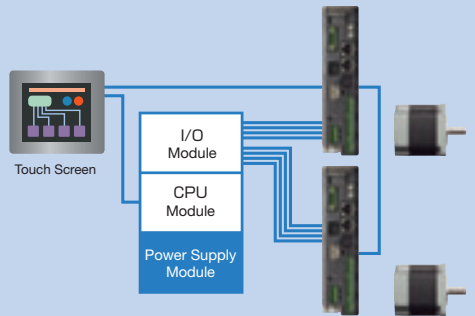

Simple Control

Suitable for one or more products

### Network Control

#### EtherCAT Control/CC-Link Control/MECHATROLINK Control

EtherCAT communication, CC-Link communication and MECHATROLINK communication are available by using network converter (sold separately). Operating data and parameters can be set and operation commands can be input using various communication methods. Also it shortens the design time.

- Multi-axis control with simple host.
- Can be connected with different types of network.
- Able to send information to a group of slaves at the same time.
- EtherCAT, MECHATROLINK: 16 axes max
- CC-Link: 12 axes max

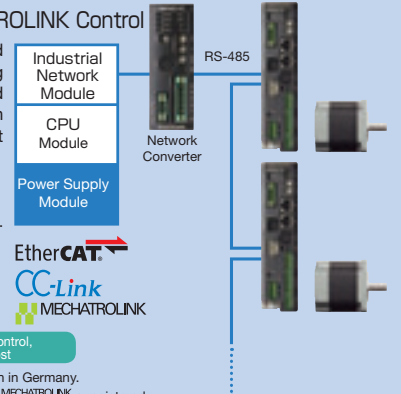

Simple Control

Simple Wiring

Multi-axis control, lower cost

● EtherCAT is a registered trade mark licensed by Beckhoff Automation in Germany.  
 ● CC-Link is a registered trademark of CC-Link Partner Association. MECHATROLINK is a registered trademark of MECHATROLINK Members Association.

FLEX is a generic name of the products which support Industrial Network control via I/O control, Modbus (RTU) control and network converter.



Built-In Controller Type  
**FLEX**

# Modbus (RTU) Control

● Modbus is copyright of Schneider Automation Inc.

## Modbus (RTU) control via PLC

RS-485 communication can be used to set operating data, parameters and input operation commands. A maximum of 31 drivers can be connected to one serial unit. There is also a function for simultaneously starting multiple axes. The motor has a function that enables multiple shafts to be started simultaneously. The protocol supports Modbus (RTU), enabling connection with devices such as touch-screen panel computers and PCs.

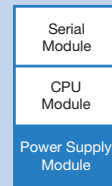

- Simple Control
- Simple Wiring
- Compatible with serial unit of several manufactures

## Modbus (RTU) control via PC

Operating data, parameters and input operation commands can be input via RS-485 communication board into PC. It also suitable for PC Facility Use.



- Simple Control
- Simple Wiring
- Motor Control by PC

## Simple connect to Touch Screen

Direct connection to touch screen is available via Modbus (RTU) communication. Operating data, parameters, alarm record and trial operation can be controlled without PLC.

Use touch screen instead of switch

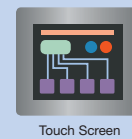

※ Pro-face (Digital Electronics Corporation) provides exclusive templates for Oriental Motor "Cockpit". For more detail, please refer to Digital Electronics Corporation's website.

- Simple Control
- Simple Wiring
- System Simplification

## Introduction of Features

### Group Sending Function

The group sending function simultaneously starts the multi-axis via Modbus (RTU) or Industrial Network.

Group some drivers, the axes then send operation command to main driver, other drivers in the same group will start operation simultaneously

- Modbus (RTU): Simultaneous start, change of moving angle or speed, monitor are possible.
- Industrial Network: Simultaneous only

### ● Modbus (RTU) Communication

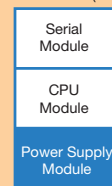

Multi-axis simultaneous starting is possible

ADVANTAGE  
**Built-in controller type is compatible with several kinds of system or network.**

# HIGH

PERFORMANCE & RELIABILITY

Performance and function to enhance reliability.

## High Accuracy

High Accurate Positioning

Positioning accuracy of the **RKII** Series is  $\pm 0.05^\circ$  ( $\pm 3$  arc min). When the **RKII** Series is used with a ball screw as shown in the below drawing, the stopping accuracy becomes  $\pm 1.4 \mu\text{m}$ . The accuracy of the normal ground ball screw is  $\pm 10 \mu\text{m}$ , thus the accuracy is high enough for positioning operation.

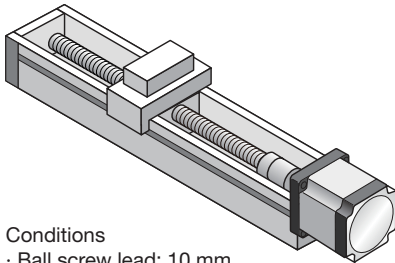

Conditions  
 · Ball screw lead: 10 mm  
 · Motor to be used: **RKII** series  
**Stopping Accuracy  $\pm 1.4 \mu\text{m}$**

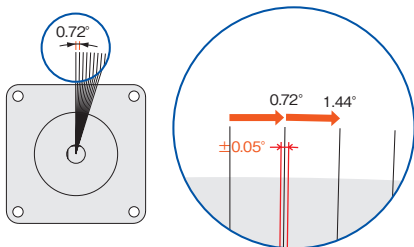

**Positioning Accuracy  $\pm 0.05^\circ$**

ADVANTAGE  
**High accuracy in positioning  $\pm 0.05^\circ$ .**

## High Torque

Compact and High Torque

The **RKII** Series is compact and produces high torque. The torque of the 42 mm frame size model has increased 50%. This contributes to a reduction in positioning and move time. The series includes 60 mm and 85 mm framesize models to cover a wide torque range.

● Note that for 60 mm and 85 mm frame size models, the torque is equivalent to the conventional model.

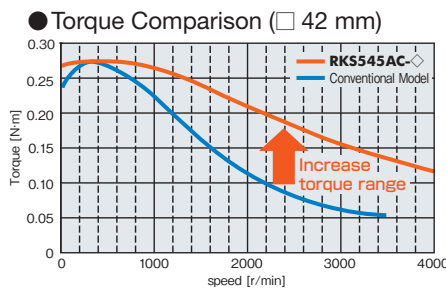

## High Efficiency

Shorten Positioning Time

With conventional stepping motors, in applications where heat generation had to be suppressed, the operating current had to be reduced, which also reduced torque. With the **RKII** Series, thanks to its low heat generating, highly efficient motors, the motor torque can be used fully to reduce positioning time.

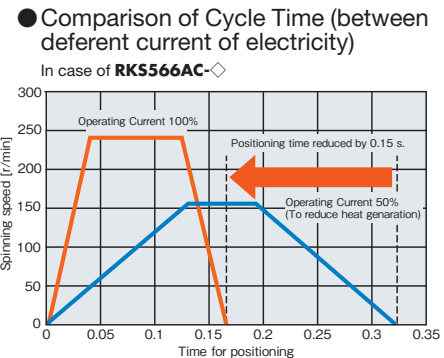
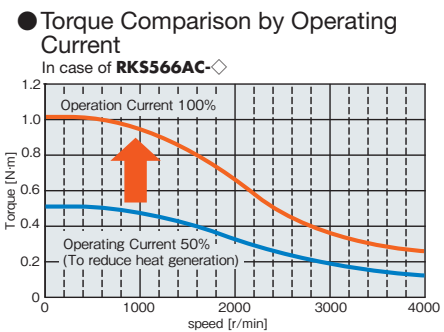

ADVANTAGE  
**Shorten time for positioning.**

# Low Vibration

Digital controlled driver

Utilizing a full-time microstepping driver controlled by a digital system improves the vibration characteristics of the 0.72° stepper motor. Current control is also done by a high specification digital CPU. This model uses PWM control instead of PAM control resulting in a sinusoidal wave form in each phase, significantly reducing vibration.

## ● Current Waveform in Motor (theoretical figure)

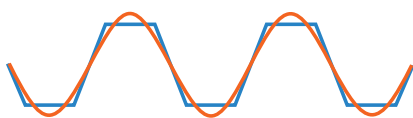

— RKII series: sinusoidal wave  
— Conventional products: trapezoidal wave

Current in the motor is changed from trapezoidal wave to sinusoidal wave, which resulted in less vibration.

## ● Vibration Characteristics Comparison

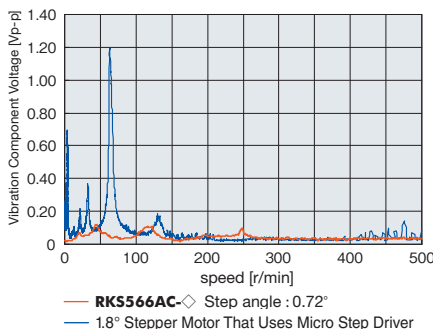

— RK5566AC ◁ Step angle : 0.72°  
— 1.8° Stepper Motor That Uses Micro Step Driver

**ADVANTAGE**  
Vibration has been reduced drastically.

# Resolution

Step angle can be set easily

For pulse input type, 32 step angles can be selected. To easily upgrade from a 1.8° stepper motor, use the step angle setting switch to match the existing input pulses to the desired output speed and position. There is no software or control module required.

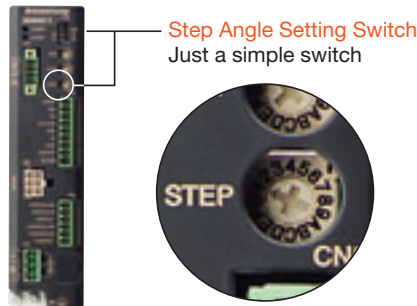

Step Angle Setting Switch  
Just a simple switch

For built-in controller type, the value can be between 200 p/r - 200,000 p/r. Setting can be done by a Control module, software or RS-485 communication.

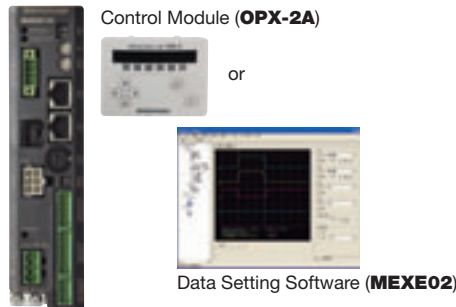

Control Module (OPX-2A)

or

Data Setting Software (MEXE02)

**ADVANTAGE**  
Optimal resolutions can be selected.

# Protective Function

Various kinds of protection are installed

Many types of protection functions are integrated into the driver. A blinking LED (blink count determines alarm type) indicates when an alarm is triggered.

## (Example of alarm)

- Main circuit overheating
- Overvoltage
- Command pulse error
- Overcurrent
- Undervoltage
- Electrolytic capacitor error
- EEPROM error
- CPU error
- Automatic electromagnetic brake control error

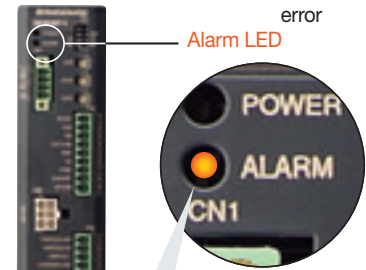

Alarm LED

Example: Alarm LED blinking three times

Overvoltage alarm

## [Causes]

- Power supply voltage exceeded the permissible value.
- A large inertial load was stopped suddenly or lifted or lowered.

**ADVANTAGE**  
Check troubles with protection function.



# Lineup



## ● List of drivers and motors

Driver Type	Motor Type	Frame Size	Electro-magnetic Brake	Power Input
Built-in Controller Type 	Standard Type	42 mm 60 mm 85 mm	●	Single Phase 100-120 VAC Single Phase 200-240 VAC
	Standard Type with Encoder	42 mm 60 mm 85 mm	—	
	<b>TS</b> Geared Type <b>PS</b> Geared Type Harmonic Geared Type	42 mm 60 mm 90 mm	●	

Driver Type	Motor Type	Frame Size	Electro-magnetic Brake	Power Input
Pulse Input Type 	Standard Type	42 mm 60 mm 85 mm	●	Single Phase 100-120 VAC Single Phase 200-240 VAC

## ● List of Standard Type, Geared Type and Features

\*We provide encoder installed model, but only for the built-in controller models.

Type	Features	Permission Torque, Maximum Torque (N·m)	Backlash (arc min)	Basic Resolution (°/pulse)	Output Shaft Speed (r/min)
Standard Type   with Encoder*	<ul style="list-style-type: none"> <li>Basic model of the <b>RKII</b> series</li> <li>with Encoder</li> <li>For encoder installed model, functions for monitoring positioning data, detecting positioning gap are available.</li> <li>Resolution of encoder installed: 500 p/r.</li> </ul>	Maximum holding torque 6.3	—	0.72	6000
<b>TS Geared Type</b> (Spur Gear Mechanism)	<ul style="list-style-type: none"> <li>High torque (Double of existing products)</li> <li>A wide variety of reduction gear ratios, high-speed operations</li> <li>Gear ratio types 3.6, 7.2, 10, 20, 30</li> </ul>	Permission torque, Maximum torque 25 45	10	0.024	833
<b>PS Geared Type</b> (Planetary Gear Mechanism)	<ul style="list-style-type: none"> <li>Less backlash (comparing with existing products)</li> <li>High permission torque, maximum torque</li> <li>A various reduction gear ratio lineup make easy to detect angle</li> <li>Center shaft</li> <li>Gear ratio types 5, 7.2, 10, 25, 36, 50</li> </ul>	Permission torque, Maximum torque 37 60	7	0.0144	600
Harmonic Geared Type (Harmonic Drive)	<ul style="list-style-type: none"> <li>Longer mechanical life (Double of existing products)</li> <li>Higher torque (1.3 times of existing products)</li> <li>High accuracy in positioning</li> <li>High permission torque, maximum torque</li> <li>High reduction ratio, high resolution</li> <li>Center shaft</li> <li>Gear ratio types 50, 100</li> </ul>	Permission torque, Maximum torque 52 107	0	0.0072	70

### Note

- Above values are for reference only. Values can be changed depending on setting angle or reduction ratio.
- Harmonic drive and  are registered trademarks of Harmonic drive systems Inc or trademarks.

Geared motors offered by Oriental Motor, quick reference chart for performance and price.

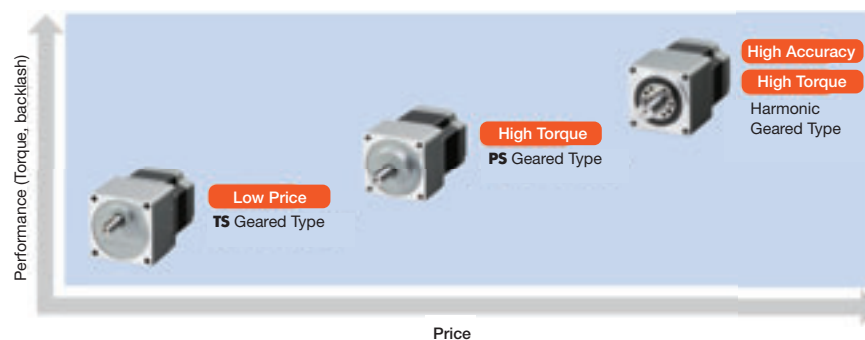

# Features of New Lineup

## **NEW** Standard Type with Encoder (Built-in controller type only)

Encoder installed models make it possible to monitor the present position and detect for errors.



### ● Positioning monitor

This feature can be used to detect the position of the motor, for instance, compare the commanded position, to confirm normal operation.

### ● Return-to-Home operation by using Z-phase signal

Z-phase signal can be utilized to home return operation. Using Z-phase signal, the home return point will be detected with higher accuracy than single use of the home return sensor.

### ● Detecting for errors

The encoder will compare command position and encoder-count, if deviation exceeds set value a STEPOUT signal will be output. An alarm signal for abnormality is also available.

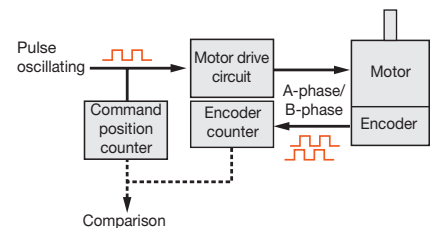

## TS Geared Type

This geared type is made with a simple spur gear design. The torque and speed have been improved.



### ● Mechanism

Because of its high accuracy, this type has the same level of accuracy when compared to our tapered (TH) type without the added cost of tapering.

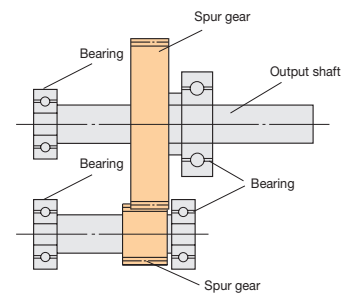
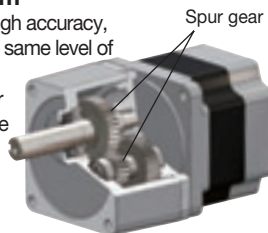

### ● Torque and speed are improved (compare with existing type)

The TS geared type realizes the improvement of permissible torque and at the same time, it can exert its maximum torque. The rated input speed is increased to 3,000 r/min, and the permissible speed range of the output shaft has been significantly increased as well. The motor allows for higher torque and shortens the time for positioning, because the maximum torque range can be used for acceleration/deceleration.

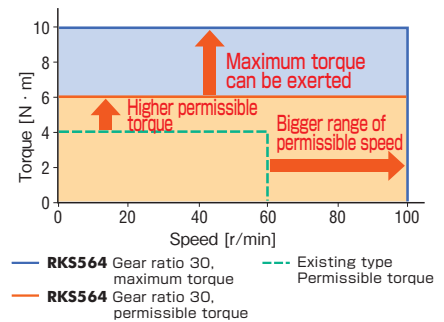

## PS Geared Type

The PS gear mechanism is comprised primarily of a sun gear, planetary gears and an internal tooth gear. The planetary gears design allows for higher output torque.



### ● Mechanism

There are gears inside used to distribute torque, which allows for higher torque than a spur gear design. The PS gear uses a higher accuracy gear design which provides for a lower backlash when compared to a spur gear design.

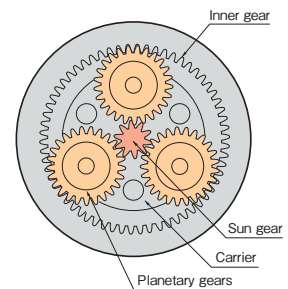

### ● Reduce backlash (Compare with existing type)

Optimal design of gears reduces backlash. (Except: □ 42 mm)  
Positioning with higher accuracy is possible.

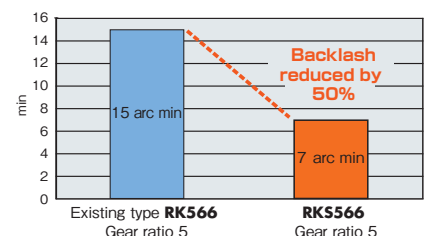

## Harmonic Geared Type

The mechanical life, permissible torque and maximum torque are improved (compare with conventional model).



### ● Improved rated life time (Twice the length of conventional models)

The rated life time has been increased from 5,000 hours (conventional models) to 10,000 hours. (Except □ 42 mm)

[Condition for rated life time]

- Torque : Permissible torque
- Type of load : Uniform load
- Input speed : 1,500 r/min
- Radial load : Permissible radial load
- Axial load : Permissible axial load

### ● Structure

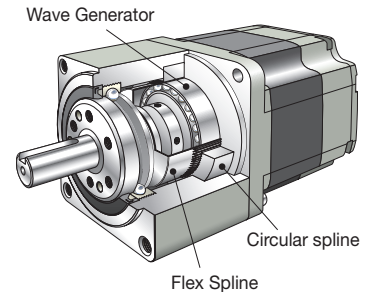

### ● High torque

With more permissible and maximum torque available, more load can be handled with the same size geared motor.

### Comparison of specification

Products name	RKS564AC-HS100-◇	Conventional model
Permissible torque N·m	10	8
Maximum torque N·m	36	28
Gear ratio	100	
Lost motion (Load torque)	0.7 arc min or less (± 0.39 N·m)	

### Comparison of torque characteristics

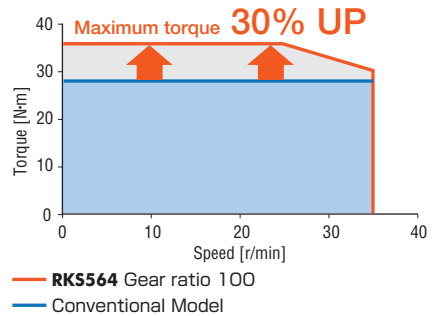
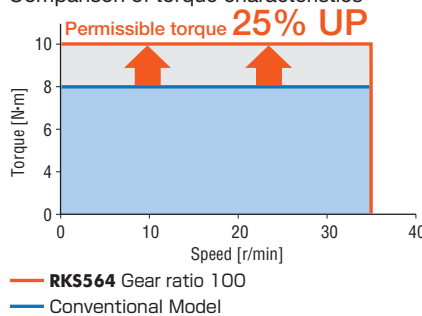

### ● Surface Installation of load is available

This type permits installation of load directly on the rotating surface integrated with the shaft. (Except: □ 90 mm)

#### Appearance and Installation

Example: This surface rotates with the shaft

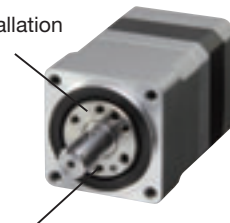

Tapped holes are provided on the rotating surface for load installation

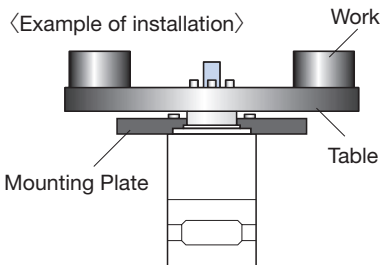

#### Application: Index Table

This type not only reduces the number of parts/processes, but also improves reliability. They are also suitable for operating loads that receive moment loads.

#### Example mechanism

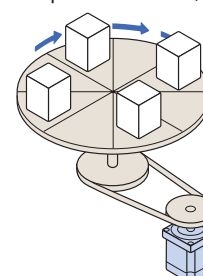

#### Surface mounting

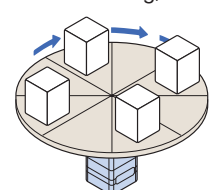

● Harmonic drive and HD SYSTEMS are registered trademarks of Harmonic Drive systems Inc or trademarks.



# Advantage of geared motor

Using geared motors bring the user many advantages, such as speed reduction, high torque and high resolution.

## The motor can drive a large inertial load

If compared with a standard motor, the geared motors can drive larger inertial loads, because it's permissible load moment of inertia increases with the square of reduction ratio.

Comparison of load moment of inertia

	Motor Type	Motor product name	Load moment of inertia (10 times of Rotor Inertia)	Diameter of inertial load (Thickness: 20 mm, material: Aluminum)	Speed range
	Standard Type	<b>RKS564AC</b> -◇	$1.6 \times 10^{-4} \text{ kg} \cdot \text{m}^2$	72 mm	0 ~ 6,000 r/min
	<b>PS</b> Geared Type (Gear ratio 5)	<b>RKS566AC-PS5</b> -◇	$40 \times 10^{-4} \text{ kg} \cdot \text{m}^2$	164 mm	0 ~ 600 r/min

## Damping characteristic at starting/stopping will be improved.

When the motor works under large inertial loads or needs to accelerate/decelerate in a short time, it is better to use the geared motor than the standard motor. Because it can reduce damping it can also increase stability. The geared motor is suitable for work that requires to position a large load (i.e. index table, arm) in a short time.

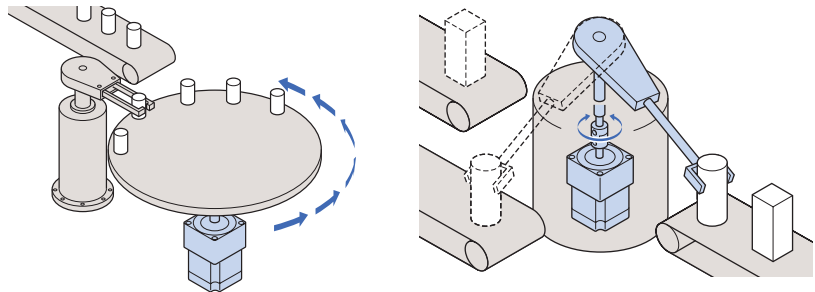

## High stiffness, not twisting easily.

The geared motor has a high stiffness and it cannot be twisted easily. It is not profoundly affected by changes of load torque (compared with standard motor).

**Application: Lifter**  
The geared motor can stop with high accuracy even for vertical applications if the load or work changes.

**Application: Security Camera**  
The motor will hold the load even if shaken by a strong wind.

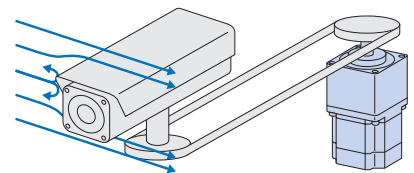
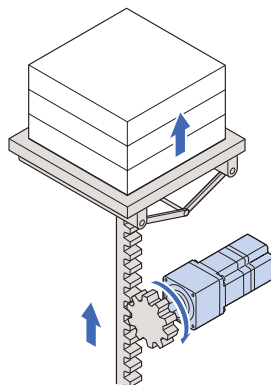

## Downsizing

If comparing the standard motor and the geared motor which have similar maximum holding torque, the setting angle of the geared motor is smaller than the standard motor. By comparing the two, the geared motor allows for a small area, saving space, allowing for downsizing.

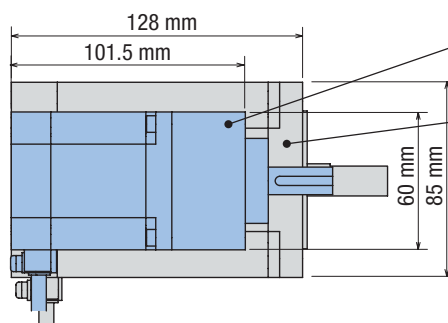

**PS Geared Motor**  
**RKS564AC-PS25**-◇ Weight: 1.4 kg, TH=8 N·m

**Standard Motor**  
**RKS5913AC**-◇ Weight: 4.1 kg, TH=6.3 N·m

※ TH means "Holding torque"