

# Bending & Shearing

## Contents

- 4 The company
- 6 Why Boschert Gizelis?
- 8-9 **GTURBOBEND**<sup>®</sup> Bending
- 10-13 **GFLEH**<sup>®</sup> Bending
- 14-17 **GBEND**<sup>®</sup> Bending
- 18-21 **GHD**<sup>®</sup> Bending
- 22-25 Options - Bending
- 26-27 Offline Software
- 28-29 Tooling - Bending
- 30-33 **SCUT**<sup>®</sup> Shearing
- 34-37 Options - Shearing
- 38 Product Range
- 39 After - Sales Service



# The company

"Gizelis S.A.", founded by Stamatis Gizelis in 1968, is specializing in manufacturing sheet-metal machinery. It is currently one of the oldest companies in its field and its activities range from machine designing and development to "in-house" manufacturing of sheet-metal processing machines.

"Gizelis S.A." is a well-established manufacturing company, always present in the global market. Today the company, due to its large network of associates worldwide, can offer solutions in sheet-metal processing machinery production chain.

In 2004 "Gizelis S.A." formed a strategic alliance with "Boschert GmbH", a company located in Germany. As a result, a new series of machines has emerged aiming to provide the customer with a full range of high-quality sheet-metal processing machines.

Both 'Boschert GmbH' and 'Gizelis S.A.' operate and are located in European Union. In addition, every manufacturing process and operating procedure take place in their privately-owned premises.

The quality of human resources is of great significance for 'Gizelis S.A.' A team of highly qualified engineers and managers, fully experienced in the field of their expertise, is responsible for the company's activities, from research and development to production and marketing.

We are strongly committed to continue investing in R&D while aiming to provide high-quality products that are technologically advanced and to design new products the rapidly changing sheet-metal industry demands.

Our mission is to provide a complete range of high-quality sheet-metal processing machines to our customers through constant development and innovation.





# Why Boschert Gizelis?

- Long stroke and daylight as standard even in basic models.
- Tradition & Reliability. Years of experience on bending and shearing.
- Step-by-step instructions and support on suitable tooling and machine selection.
- Direct service line and constant customer support.

## Bending by Boschert - Gizelis

### Press Brake Series

#### GTURBOBEND®

Ultra fast and productive hydraulic press brake up to 1.5m.

#### GFLEX®

High level press brakes up to 4-axis. The best "value for money" choice.

#### GBEND®

Superior press brakes with top-class equipment and components offering the ultimate flexibility in bending process.

#### GHD®

Heavy-duty machines for massive loads >320tons with strong rigid frame for heavy duty applications.



Double upper and lower roller bearing for accurate and fast beam movement.

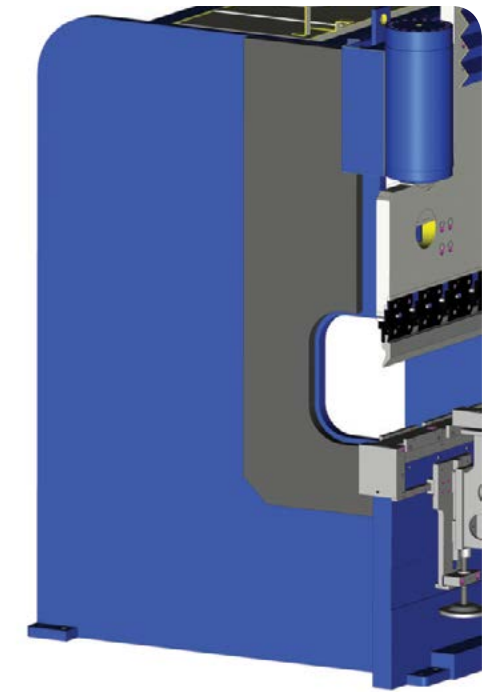

Extra external welded-steel side frame to increase machine's rigidity and minimize deformation.



Back gauge driven through ball screw and double linear guides on every axis.



Specially designed finger stops offering high accuracy and maximum flexibility even in conical bends. Maximum stop position 1200mm.

# G TURBOBEND® Series



## Standard equipment

- 2D graphic controller, 8" color Touch-Screen, CybTouch8
- Y1, Y2 independent hydraulic cylinders, proportional valve technology
- Single-axis back gauge system X
- Mechanical upper tool clamping
- Mechanical lower tool clamping
- Efficient, low-noise and accurate hydraulic system
- Beam movement on two double roller bearings on each side
- Strong and stable construction
- Bending Force: 40tons
- Working Length: 1550mm
- Distance between uprights: 1550mm
- Daylight: 400mm
- Punch Stroke: 200mm
- Fast Speed: 260mm/sec
- Working Speed: 20mm/sec\*
- Upstroke Speed: 200mm/sec
- Back gauge speed: 800mm/sec
- Main Electric Motor: 7.5kW
- Weight: 4.500kg
- Dimensions: 2300 x 1550 x 2500mm



Fast Mechanical Clamping ROL200, with vertical tool change (optional)



Fast Pneumatic Clamping ROL200 PN, with vertical tool change (optional)



Hydraulic Wila Clamping, with vertical tool change (optional)



**X-R**  
**X-R-Z1-Z2**  
**X-X'-R-Z1-Z2**



**SPEED**  
**FLEXIBILITY**  
**ACCURACY**

\* Working speed is limited according to safety regulations for CE countries.



## Standard equipment

- 2D graphic controller, 15" color Touch-Screen, CybTouch15
- Y1, Y2 independent hydraulic cylinders, proportional valve technology
- Extra welded-steel side frames
- 2-axis back gauge system, X-R
- Fast mechanical upper clamping with side tooling extraction
- CNC Crowning
- Front Supports with brushes, movable on linear guide, height adjustable
- Efficient, low-noise and accurate hydraulic system
- Beam movement on two double roller bearings on each side
- Strong and stable construction
- Throat: 400mm
- Daylight: 515mm
- Stroke: 250mm



Front Supports with brushes, movable on linear guide, height adjustable.



2-axis back gauge, X-R.



CNC Crowning.



2D graphic Controller, 15" Touch Screen, CybTouch15, including Touch Profile function and automatic bend sequence calculation.

## Benefits at a glance

 **ROBUST** Extra welded-steel side frame to increase machine's rigidity and minimize deformation.

 **ACCURACY & SPEED** Double upper and lower roller bearing for accurate and fast beam movement.

 **FLEXIBILITY** Heavy duty finger stops, with maximum stop position at 1200mm.

 **EASY OPERATING** User friendly Color Touch-Screen controller, with 2D graphics.

# CYBTOUCH IS PS

### Easy Operating

- Large touchscreen, with vivid colors and high-contrast.
- Hand drawing TouchProfile function.
- Simple pages, clear display, large keys.
- Intuitive and user-friendly interface.
- Complete programming for efficient mass-production with multiple bends.
- Easy single bends thanks to the EasyBend page.
- Online help and interactive warning pop-up.
- Comfortable wireless software updating and data back-up using PC or Notebook.
- USB port for memory sticks.
- Large selection of languages available.

### Better Bending

- Various automatic calculations of bend functions.
- Bending sequences and programs can be memorized.
- Angle, pressure and crowning management.
- Easy manual movement.

### Advanced Functions

- Automatic bend sequence calculation.
- Hand drawing Touch Profil function.

### Powerful

- 4 axes control (Y1-Y2-X-R).
- TouchProfile 2D graphic part creation with manual sequencing.
- Bend allowance calculation.
- Pressure – crowning calculation.
- Modulable tools for each part or bend.
- Punch depth calculation.
- Angle and back gauge correction.
- Delivered with PC-ModEva offline software.

		G FLEX® 2080	G FLEX® 3080	G FLEX® 3140	G FLEX® 3175	G FLEX® 3210	G FLEX® 4140	G FLEX® 4210
Bending Force	[tons]	80	80	140	175	210	140	210
Working length	[mm]	2100	3100	3100	3100	3100	4100	4100
Distance between uprights	[mm]	1550	2550	2550	2550	2550	3550	3550
Throat Depth	[mm]	400	400	400	400	400	400	400
Daylight	[mm]	515	515	515	515	515	515	515
Punch Stroke	[mm]	250	250	250	250	250	250	250
Table width	[mm]	80	80	80	114	114	114	114
Fast Speed	[mm/sec]	0-180	0-180	0-180	0-160	0-160	0-180	0-160
Working Speed*	[mm/sec]	0-20	0-20	0-20	0-20	0-20	0-15	0-15
Upstroke speed	[mm/sec]	0-160	0-160	0-160	0-140	0-130	0-160	0-130
Hydraulic pressure (max)	[bar]	275	275	275	275	275	275	275
Main electric motor	[kW]	11	11	15	18.5	22	15	22
Length	[mm]A	3000	4000	4000	4000	4000	5000	5000
Width	[mm]B	1700	1700	1800	1850	1900	1850	1900
Height	[mm]C	2600	2700	2700	2900	2900	3050	3100
Weight (approximate)	[kg]	6000	8500	10000	11200	13200	12400	14500

\* Working speed is limited according to safety regulations for CE countries

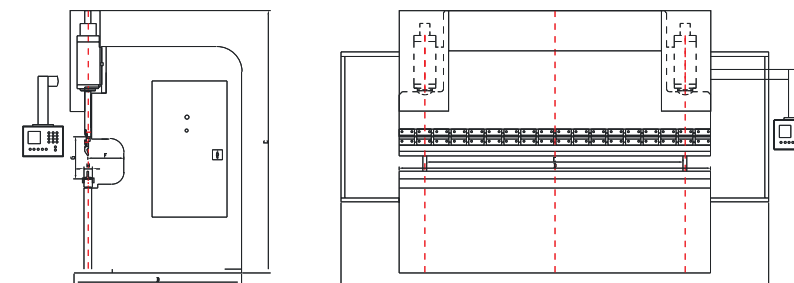



## Standard equipment

- 2D graphic controller, 8" color Touch-Screen, CybTouch8
- Y1, Y2 independent hydraulic cylinders, proportional valve technology
- Extra welded-steel side frames
- Single-axis back gauge system X
- Mechanical upper tool clamping
- Mechanical lower tool clamping
- Efficient, low-noise and accurate hydraulic system
- Beam movement on two double roller bearings on each side
- Strong and stable construction
- Throat: 400mm
- Daylight: 515mm
- Stroke: 250mm

- **Bending length: 3400mm/4400mm**
- **Usable space between frames: 3050mm/4050mm**



Back gauge guiding system on machine's sides (free space at the back)



Automatic Thickness Measurement (ATM) and Bending Program Correction (optional)



5-axis back gauge, X-X'-R-Z1-Z2 (optional)



Heavy-duty front supports, moveable on linear guide, height adjustable (optional)



Manually measuring the bending angle and Bending Program Correction (optional)

		G Bend <sup>®</sup> 2080	G Bend <sup>®</sup> 2580	G Bend <sup>®</sup> 3080	G Bend <sup>®</sup> 3110	G Bend <sup>®</sup> 3140	G Bend <sup>®</sup> 3175	G Bend <sup>®</sup> 3210	G Bend <sup>®</sup> 3290	G Bend <sup>®</sup> 3320
<b>Bending Force</b>	[tons]	80	80	80	110	140	175	210	290	320
<b>Working length</b>	[mm]	2100	2900	3400	3400	3400	3400	3400	3400	3400
<b>Distance between uprights</b>	[mm]	1550	2550	3050	3050	3050	3050	3050	3050	3050
<b>Throat Depth</b>	[mm]	400	400	400	400	400	400	400	400	400
<b>Daylight</b>	[mm]	515	515	515	515	515	515	515	515	515
<b>Punch Stroke</b>	[mm]	250	250	250	250	250	250	250	250	250
<b>Table width</b>	[mm]	84	84	84	84	84	118	118	118	118
<b>Fast Speed</b>	[mm/sec]	0-180	0-180	0-180	0-180	0-180	0-160	0-160	0-150	0-120
<b>Working Speed *</b>	[mm/sec]	0-20	0-20	0-20	0-20	0-20	0-20	0-20	0-15	0-10
<b>Upstroke speed</b>	[mm/sec]	0-160	0-160	0-160	0-160	0-160	0-140	0-130	0-120	0-100
<b>Hydraulic pressure (max)</b>	[bar]	275	275	275	275	275	275	275	275	275
<b>Main electric motor</b>	[kW]	11	11	11	15	15	18.5	22	30	30
<b>Length</b>	[mm]A	3200	3700	4400	4400	4400	4400	4400	4400	4400
<b>Width</b>	[mm]B	1700	1700	1700	1700	1700	1800	1950	1950	2100
<b>Height</b>	[mm]C	2700	2700	2700	2750	2800	2950	3000	3100	3100
<b>Weight</b>	[kg]	7300	8000	8500	9500	11000	12500	14500	16200	18800

\* Working speed is limited according to safety regulations for CE countries.

		G Bend <sup>®</sup> 4140	G Bend <sup>®</sup> 4175	G Bend <sup>®</sup> 4210	G Bend <sup>®</sup> 4290	G Bend <sup>®</sup> 4320	G Bend <sup>®</sup> 6175	G Bend <sup>®</sup> 6210	G Bend <sup>®</sup> 6290	G Bend <sup>®</sup> 6320
<b>Bending Force</b>	[tons]	140	175	210	290	320	175	210	290	320
<b>Working length</b>	[mm]	4400	4400	4400	4400	4400	6100	6100	6100	6100
<b>Distance between uprights</b>	[mm]	4050	4050	4050	4050	4050	5050	5050	5050	5050
<b>Throat Depth</b>	[mm]	400	400	400	400	400	400	400	400	400
<b>Daylight</b>	[mm]	515	515	515	515	515	515	515	515	515
<b>Punch Stroke</b>	[mm]	250	250	250	250	250	250	250	250	250
<b>Table width</b>	[mm]	118	118	118	118	118	118	118	118	118
<b>Fast Speed</b>	[mm/sec]	0-180	0-160	0-160	0-150	0-120	0-160	0-160	0-160	0-120
<b>Working Speed *</b>	[mm/sec]	0-15	0-15	0-15	0-10	0-8	0-10	0-10	0-10	0-7
<b>Upstroke speed</b>	[mm/sec]	0-160	0-140	0-130	0-120	0-90	0-140	0-130	0-120	0-90
<b>Hydraulic pressure (max)</b>	[bar]	275	275	275	275	275	275	275	275	275
<b>Main electric motor</b>	[kW]	15	18.5	22	30	30	18.5	22	30	30
<b>Length</b>	[mm]A	5400	5400	5400	5400	5400	7400	7400	7400	7400
<b>Width</b>	[mm]B	1800	1800	1950	1950	2100	1800	1950	1950	2400
<b>Height</b>	[mm]C	3100	3150	3200	3400	3400	3400	3600	3900**	3900**
<b>Weight</b>	[kg]	13600	15600	18000	22000	24000	23000	24000	28000	30000

\* Working speed is limited according to safety regulations for CE countries

\*\* The machine is partially in the ground (special foundation required).

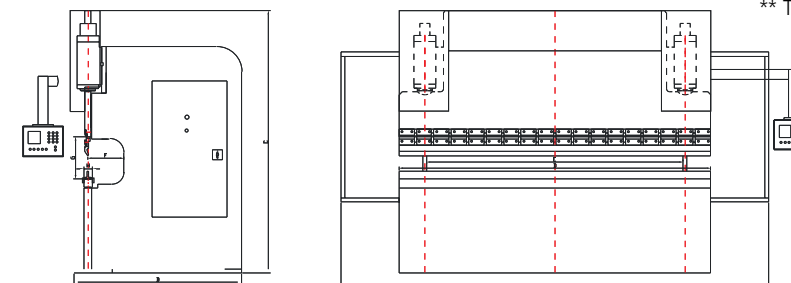



## Standard equipment

- ↘ 2D graphic controller, 8" color Touch-Screen, CybTouch8
- ↘ Y1, Y2 independent hydraulic cylinders, proportional valve technology
- ↘ Extra welded-steel side frames
- ↘ Strong and stable construction
- ↘ Efficient, low-noise and accurate hydraulic system
- ↘ Beam movement on heavy-duty bronze sliders to secure safety and accuracy
- ↘ Single-axis back gauge system X
- ↘ Mechanical upper tool clamping
- ↘ Mechanical lower tool clamping
- ↘ Stroke & Daylight customised depending on model and customer's request
- ↘ Throat: 500mm
- ↘ Daylight: 570mm
- ↘ Stroke: 320mm





Beam movement on heavy-duty bronze sliders to secure safety and accuracy



6-axis back gauge, X1-X2-R1-R2-Z1-Z2 (optional)



Adjustable V-die system, CNC or manually adjusted (optional)



Heavy-duty clamping system up to 350t/m (optional)



ASF System: Automatic Sheet Follower (CNC Bending Aid)



i-measure: Laser measurement of the bending angle and real time correction (optional)



Special made finger stop for thick material (optional)

		G HD <sup>®</sup> 4440	G HD <sup>®</sup> 6440	G HD <sup>®</sup> 6550	G HD <sup>®</sup> 6660	G HD <sup>®</sup> 6880	G HD <sup>®</sup> 7550	G HD <sup>®</sup> 7880
<b>Bending Force</b>	[tons]	440	440	550	660	880	550	880
<b>Working length</b>	[mm]	4100	6100	6100	6100	6100	7100	7100
<b>Distance between uprights</b>	[mm]	3550	5050	5050	5050	5050	6050	6050
<b>Throat Depth</b>	[mm]	500	500	500	500	500	500	500
<b>Daylight</b>	[mm]	570	570	590	590	650	590	650
<b>Punch Stroke</b>	[mm]	320	320	350	350	380	350	380
<b>Table width</b>	[mm]	220	220	220	220	220	220	220
<b>Fast Speed</b>	[mm/sec]	0-100	0-100	0-100	0-90	0-90	0-90	0-90
<b>Working Speed *</b>	[mm/sec]	0-7	0-7	0-7	0-7	0-7	0-7	0-7
<b>Upstroke speed</b>	[mm/sec]	0-90	0-90	0-90	0-80	0-80	0-80	0-80
<b>Hydraulic pressure (max)</b>	[bar]	275	275	275	275	275	275	275
<b>Main electric motor</b>	[kW]	30	30	37	45	55	37	55
<b>Length</b>	[mm]A	5400	7400	7400	7400	7400	8400	8400
<b>Width</b>	[mm]B	2700	2700	2700	2800	2800	2800	2800
<b>Height</b>	[mm]C	3400**	3750**	3800**	4100**	4100**	3800**	4100**
<b>Weight</b>	[kg]	29000	37000	39000	55000	63000	65000	78000

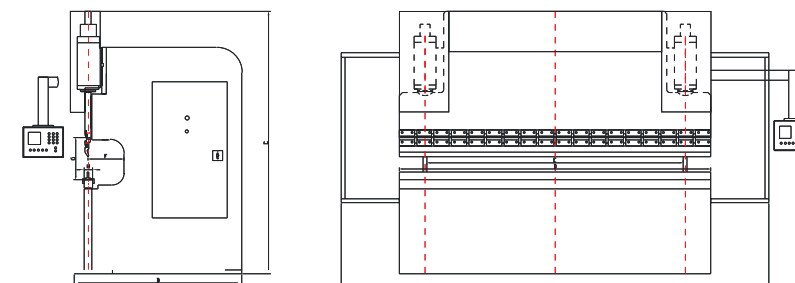

\* Working speed is limited according to safety regulations for CE countries  
 \*\* The machine is partially in the ground (special foundation required).





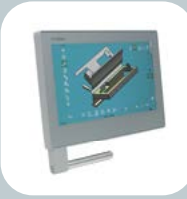

## Optional Equipment

G-TURBOBEND® G-FLEX® G-BEND® G-HD®

### Industrial Controls

	G-TURBOBEND®	G-FLEX®	G-BEND®	G-HD®
 Cybelec CybTouch 15, 15" Touch Screen, 2D graphical controller	✓	✓	✓	✓
 Cybelec VisiPac 19, 19" Touch Screen, 2D graphical controller	✓		✓	✓
 Cybelec VisiTouch 19 MX, 19" Touch Screen, 3D graphical controller	✓		✓	✓



### Clamping Systems

 ROL200, Fast mechanical clamping with vertical tool exchange <i>(standard tools/no tool modification required)</i>	✓	✓	✓	✓
 ROL200PN, Fast pneumatic upper-tool clamping with vertical tool exchange <i>(standard tools/no tool modification required)</i>	✓	✓	✓	✓
 ROL 1, Fast mechanical upper-tool clamping with vertical tool exchange <i>(tool modification required)</i>	✓	✓	✓	✓
 Hydraulic clamping for upper & lower tooling, WILA - Premium/Pro Version	✓	✓	✓	✓

## Optional Equipment

G-TURBOBEND® G-FLEX® G-BEND® G-HD®



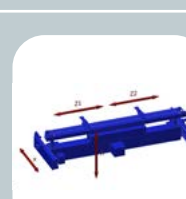
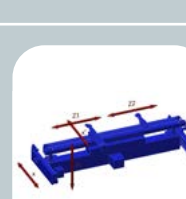
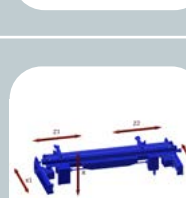
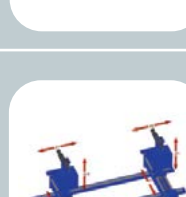

### Back Gauge

	G-TURBOBEND®	G-FLEX®	G-BEND®	G-HD®
 Single-axis back gauge, X	✓		✓	✓
 2-axis back gauge, X-R	✓	✓	✓	✓
 4-axis back gauge, X-R-Z1-Z2	✓		✓	✓
 5-axis back gauge, X-X'-R-Z1-Z2	✓		✓	✓
 5-axis back gauge, X1-X2-R-Z1-Z2			✓	✓
 6-axis back gauge, X1-X2-R1-R2-Z1-Z2			✓	✓



## Optional Equipment

G-TURBOBEND® G-FLEX® G-BEND® G-HD®



### Front Supports & Bending Aids

	G-TURBOBEND®	G-FLEX®	G-BEND®	G-HD®
 Heavy-duty front supports, moveable on linear guide, height adjustable (2 pieces)			✓	✓
 Front supports with brushes, movable on linear guide, height adjustable (2 pieces)		✓		
 CNC Front support (CNC bending aid)			✓	✓
 Parking position for front supports			✓	✓

### Anti-deflection (Crowning) Systems

	G-TURBOBEND®	G-FLEX®	G-BEND®	G-HD®
 Manual anti-deflection system (crowning)			✓	✓
 CNC-controlled anti-deflection system (crowning)		✓	✓	✓



### Safety

	G-TURBOBEND®	G-FLEX®	G-BEND®	G-HD®
 Safety laser Fiessler AKAS-LC, manual adjustment depending on the upper-tool height	✓	✓	✓	✓
 Safety laser Fiessler AKAS-3, automatic adjustment depending on the upper-tool height	✓	✓	✓	✓



## Optional Equipment

G-TURBOBEND® G-FLEX® G-BEND® G-HD®

### Automation & Measurement

	G-TURBOBEND®	G-FLEX®	G-BEND®	G-HD®
 Bending Angle Measuring with laser and Bending Program Correction			✓	✓
 Manually Measuring Bending Angle and Bending Program Correction	✓	✓	✓	✓
 Automatic Thickness Measurement (ATM) and Bending Program Correction			✓	✓

### Extra

	G-TURBOBEND®	G-FLEX®	G-BEND®	G-HD®
 Air-condition system for installation in countries with extreme weather conditions	✓	✓	✓	✓
 Robotic applications	✓	✓	✓	✓
 Simultaneous operation of two or more machines.			✓	✓

### Software

	G-TURBOBEND®	G-FLEX®	G-BEND®	G-HD®
 BG Soft, CAD/CAM Bending Software with auto tool selection and bend sequence selection (compatible with all Cybelec's controllers)	✓	✓	✓	✓

**THE PROBLEM** What you design in not what you produce!

**WHY?** Because, the unfolding and cutting process does not take under consideration bending parameters (e.g. available tools, tools radius, etc.).

**THE SOLUTION** BG-soft combines the BG-soft Cut and BG-soft Bend in one unified environment. In this way every aspect of the manufacturing process (bending and cutting) is calculated, thus.



## WHAT YOU DESIGN....

....IS WHAT YOU GET!!

BG-soft bend is an application for programming and simulating Boschert Gizelis press brakes, used for maximizing production resources. BG-soft bend enables offline generation of bend sequences and tooling setups, with dynamic 3D simulation for checking collisions of the part with tools, fingers and machine components.

### Features

- Direct part transfer from SolidWorks, Solid Edge and Inventor
- Importing and unfolding of IGES and STEP 3D parts
- Automatic and manual tool selection based on material, machine and tool properties
- Automatic and manual bend sequencing with collision detection
- Automatic and manual fingerstop positioning with graphic control of all axes
- Automatic retraction calculation
- 3D simulation of the bending process with collision detection
- Native NC generation enables direct loading of programs to the machine control
- Comprehensive Setup Reports for the machine operator including bend sequence, tooling and bend-by-bend graphics

### Advantages

- BG-soft bend enhances your productivity with:
- Faster design-to-production times with automated features
- Offline programming means minimal machine down-time
- Collision-less bend sequences mean reduced stock wastage
- BG-soft bend tool library is compatible to available tooling resulting in production-ready
- Setup Reports

**3D Simulation and Collision Detection**  
**Efficient Tool Selection**  
**Bend Sequence Selection**  
**Fingerstops Positioning**

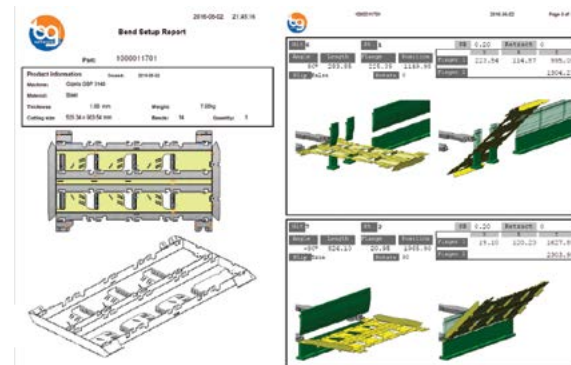
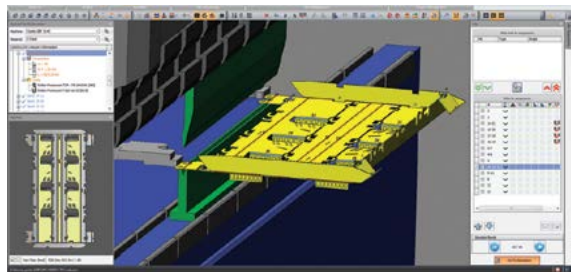
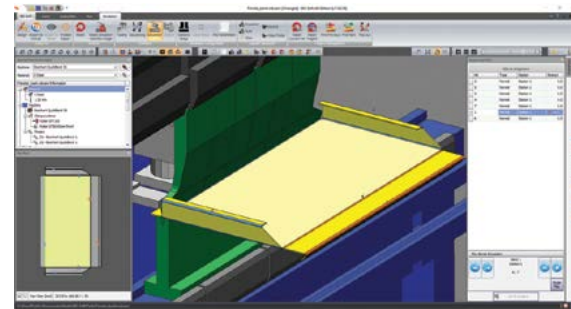

### SETUP REPORTS

- Comprehensive Setup Reports include:
- Bend sequence instructions
  - Tool setup details
  - Product handling
  - Bend-by-bend graphics

BG-soft cut is the only system that integrates CAD/CAM capabilities in the same module:

Geometry, dimensions and technology (punching/cutting) are completely associative - when the geometry is modified, the dimensions and technology update automatically!

**FROM THE IDEA...  
TO REALITY..**

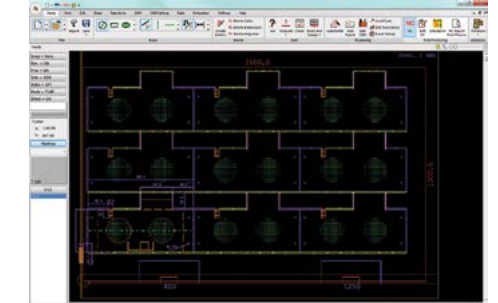
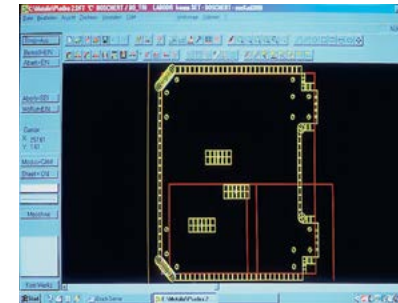

### AUTOMATIC NESTING

BG-soft cut offers optimal material utilization with AutoNest - cnc automatic nesting module. AutoNest is a powerful True Shape nesting tool offering versatile methods for automatic and manual nesting to achieve the best possible nesting solutions.

### 3D CAD INTERFACE

The CAD Link module enables one-click real-time transfer of parts from 3D CAD packages to BG-soft cut. Parts can be transferred from SolidWorks®, Solid Edge®, Autodesk® Inventor®, PTC Creo®, and Vertex® G4, using an on-line associative link, bypassing the need for intermediate files such as DXFs.

### DRAFTING

BG-soft cut has a very powerful, easy to use 2D drafting module. In addition to a full set of drafting tools, BG-soft cut supports special sheet metal drafting aids and geometry validation to automatically detect and correct unclosed contours.

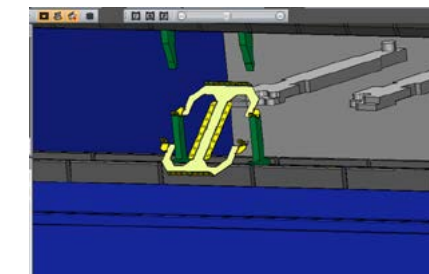
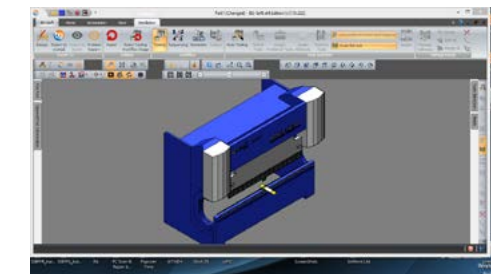

### PUNCH TECHNOLOGY

The Punching module supports:

- Auto-Punch
- Special Tools
- Auto-Indexing
- Automatic Reposition
- Common Cuts

### CUTTING TECHNOLOGY

The Cutting module supports:

- Auto-Cut
- Contour Check and Correction
- Beam Width definition and Auto Compensation
- Art Parts
- Corner Loops and Corner Slow Down
- Z axis control
- Open Contour Cutting

### DATA REPORTS

Detailed production reports for individual parts, nesting solutions and costing estimation, using fully customizable templates with barcode.



# Gcut<sup>®</sup> CNC Series



## Standard equipment

- Swing beam hydraulic shear
- Heavy-duty, all-welded-steel rigid frame
- Hold-down pressure adjustment depending on cutting pressure
- Color Touch Screen 15"
- Programmed cutting length
- Close hold-downs near the squaring arm for better small-part holding & cutting
- High-speed CNC back gauge with AC servomotor
- Precision lighting on the cutting line
- Specially-made cutting blades suitable for both steel and stainless steel
- Ball casters on the table
- Finger-protection safety fence (accessible)
- Safety system on the back including side doors and photocells
- Front-sheet supports 1m each with linear scale
- 1x squaring arm 1m with linear scale
- Electric parts by Siemens, Telemecanique
- Hydraulic parts by BOSCH-REXROTH



Movable Front support (optional)

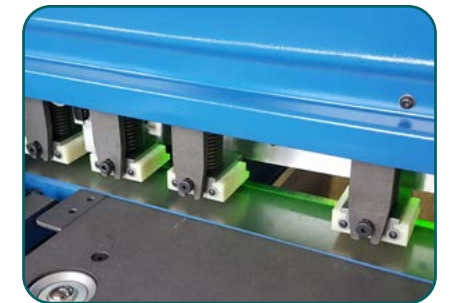

Specially-designed rectangular hold-downs, suitable for cutting narrow stripes (optional)



Color Touch Screen 15", movable along machine's length (optional)



Finger protection with light guards (optional)

		<b>G Cut<sup>®</sup> CNC 2504</b>	<b>G Cut<sup>®</sup> CNC 3006</b>	<b>G Cut<sup>®</sup> CNC 3010</b>	<b>G Cut<sup>®</sup> CNC 3013</b>	<b>G Cut<sup>®</sup> CNC 3016</b>	<b>G Cut<sup>®</sup> CNC 3020</b>	<b>G Cut<sup>®</sup> CNC 4006</b>
Maximum cutting thickness mild steel st42	[mm]	4	6	10	13	16	20	6
Maximum cutting thickness stainless steel	[mm]	2	4	6	8	10	12	4
Maximum cutting length	[mm]	2600	3100	3100	3100	3100	3100	4100
Throat Depth	[mm]	155	180	210	210	260	260	180
Back gauge stroke	[mm]	1000	1000	1000	1000	1000	1000	1000
Cutting angle	[degrees]	1.26	1.42	1.79	1.97	2.33	2.85	1.49
Maximum hydraulic pressure	[bar]	255	255	255	255	255	255	255
Main Motor Power	[kW]	7.5	11	15	22	30	37	11
Length	[mm]	3450	3950	3950	3950	3950	3950	4950
Width	[mm]	3500	3900	4100	4500	4500	4500	3900
Height	[mm]	1950	1950	2050	2200	2550	2550	2050
Weight	[kg]	5900	8300	10500	13000	17000	24000	11800

		<b>G Cut<sup>®</sup> CNC 4010</b>	<b>G Cut<sup>®</sup> CNC 4013</b>	<b>G Cut<sup>®</sup> CNC 4016</b>	<b>G Cut<sup>®</sup> CNC 4020</b>	<b>G Cut<sup>®</sup> CNC 6006</b>	<b>G Cut<sup>®</sup> CNC 6010</b>	<b>G Cut<sup>®</sup> CNC 6013</b>
Maximum cutting thickness mild steel st42	[mm]	10	13	16	20	6	10	13
Maximum cutting thickness stainless steel	[mm]	6	8	10	12	4	6	8
Maximum cutting length	[mm]	4100	4100	4100	4100	6100	6100	6100
Throat Depth	[mm]	220	220	220	220	305	305	305
Back gauge stroke	[mm]	1000	1000	1000	1000	1000	1000	1000
Cutting angle	[degrees]	1.91	2.05	2.18	2.20	1.46	1.5	1.5
Maximum hydraulic pressure	[bar]	255	255	255	255	255	255	255
Main Motor Power	[kW]	15	30	30	37	15	22	30
Length	[mm]	4950	4950	4950	5200	6950	6950	6950
Width	[mm]	4100	4500	4800	4800	4100	4500	4500
Height	[mm]	2200	2250	2550	2700	2000	2400*	2400*
Weight	[kg]	15000	16800	24000	28000	22000	28000	36000

\*\* The machine is partially in the ground (special foundation required).

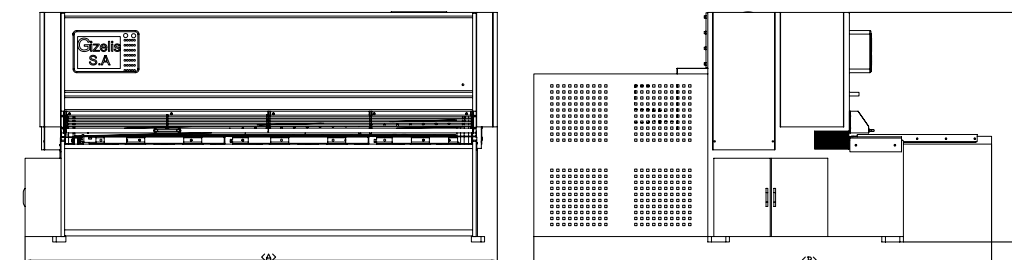

# Gcut<sup>®</sup> CNC SERIES

## Optional equipment

### ↘ RSS System: Rear Sheet Support

The RSS System is essential for cutting thin sheet-metals and wide strips because while the sheet-metal is put in the shear, due to its weight, it bends and it stops at the wrong position on the back gauge. Thus, it is mis-measured and wrongly as well as badly cut.

Applying RSS System, the sheet-metal is properly supported at the back, so it:

- does not bend
- is properly positioned on the back gauge so accurately measured and rightly cut

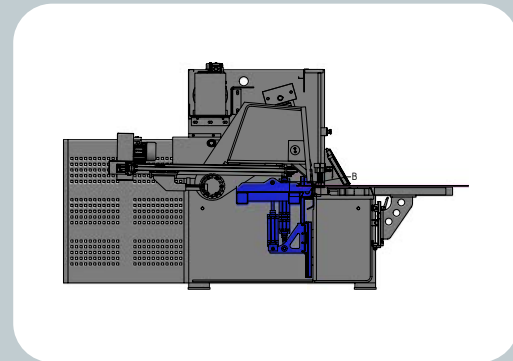

**Position 1:** Thanks to the RSS System, the sheet-metal is supported on the back gauge and does not bend.

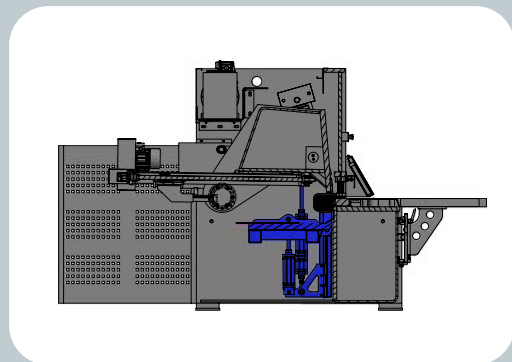

**Position 2:** The RSS moves downward about 150mm, stops and takes the entire sheet-metal to be cut so that the cut stripe does not bend due to its weight and touch the floor.

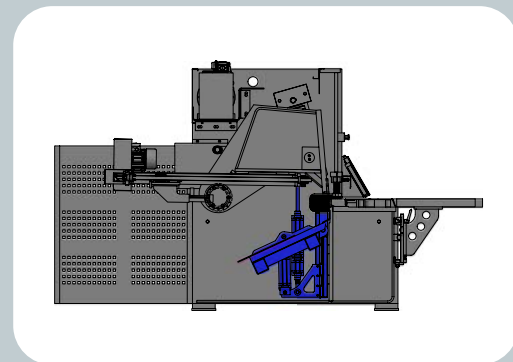

**Position 3:** The RSS moves even further while inclining so that the sheet-metal moves out of the machine.

### ↘ RTF System: Return to the front

If someone would like to cut a sheet-metal the 'traditional' way, the cut (clean) piece of sheet-metal would come out at the back of the shear and fall on the floor. This way, the sheet-metal may hit other – already cut – sheet-metals or fall on the floor. Consequently, marks or scratches may be caused on the piece; no one wants this to happen, especially when it comes to manufactures of materials such as stainless steel or steel. In both cases, any mark on the surface of the piece must be avoided. While applying RTF System, the cut piece does not fall down at the back of the shear. On the contrary, it returns directly to the hands of the operator at the front!

This means:

- No mark on the surface
- No scratches
- Time-saving since the operator doesn't have to leave his place to collect the piece at the back of the machine.

*\*Sheet-Support-System installation required.*

### ↘ NSC System: Narrow Strip Cutting

The application of the innovative NSC System offers the operator the capability to cut narrow strips without being deformed.

The operator programs how many strips are needed, e.g. 4 stripes, 30mm wide each, and the system will automatically cut them, return them to the operator at the front flat with no deformation whatsoever.

*\*Sheet-Support-System installation required*



### ↘ MPF System: Movable Front Panel

A unique feature of the shears produced by Gizelis is that the front panel is movable along the machine.

Thus, the operator works while having the panel in front of him even if he cuts a sheet-metal at the other end.



### ↘ ATM System: Automatic Thickness Measurement

While setting the gap between the blades (clearance), the operator may mistype or set the wrong material thickness. In order to avoid this, the machine is equipped with a special sensor which automatically measures the material's thickness. The right figures appear on the panel and the clearance is set automatically.



### ↘ MFS System: Movable Front Supports

The two front supports can be moved manually, yet separately, along the machine so that the operator adjusts them according to the length of the metal piece.



## Optional equipment

Rectangle holders with synthetic cups to cut narrow strips without being deformed.

*\*NSC system required.*



Brushes on table and supports



Chute for small pieces



Extended Front supports



Front Protection with Light Guards



Adjustable Goniometer for angle cutting



Transport Belts



2-axis Back Gauge, X1-X2, for angle cutting



➤ Boschert-Gizelis' combined product range covers a large variety of machines, necessary for the sheet-metal processing industry, such as press brakes, shears, punching and notching machines, combined machines, portal type oxy and plasma cutting as well as laser-cutting machines. On top of these, Boschert-Gizelis Group can manufacture specially-made machines upon request.

## Bending



## Robobend

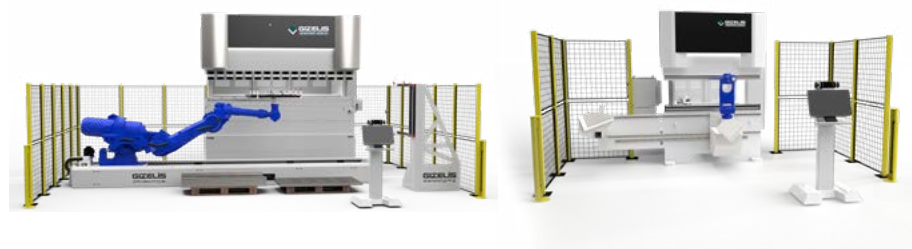

## Shearing



## CombiLaser - Punching



## Copper bar punching



## Electroline - Bending



## Electroline - Shearing



- **Teleservice** 5 days a week.
- **Service stations** 5 days a week major geographical areas:

- Germany
- Greece
- France
- Poland
- Croatia (Balkan countries)
- Russia
- India
- Thailand
- USA
- GCC countries (Bahrain, Kuwait, Qatar, Saudi Arabia, UAE)
- Mexico
- Romania

**One Group**  
**One Deal**  
**One Service center**  
**One Partner**



**| BOSCHERT GIZELIS. Co |**  
Schimatari Viotias, 32009,  
Kormatzini Area, Greece  
T: +30 22620 58675, F: +30 22620 57185,  
[www.gizelis.com](http://www.gizelis.com), [info@gizelis.gr](mailto:info@gizelis.gr)

**| BOSCHERT GmbH & Co. KG |**  
Mattenstr. 1, 79541 Loerrach,  
Postfach 7042, Deutschland,  
T: +49 7621 9593-0, F: +49 7621 55184,  
[www.boschert.de](http://www.boschert.de), [info@boschert.de](mailto:info@boschert.de)