

ProWrap

Pre-Stretch >>>>> Productivity >>>>> Robustness >>>>>

DATASHEET

SAFE • STRONG • SMART

Semi-Automatic Stretch-Wrapper

ProWrap is a semi-automatic machine to wrap palletized loads with stretch film. It provides versatile opportunities for intensive and demanding stretch film applications. Starting from carriages with electro-magnetic brake, up to the motorized Pre-Stretch version: **ProWrap** offers the right solution for advanced pallet wrapping needs.

KEY FEATURES

- ✓ **Safety First** – ProWrap incorporates several safety features as standard
- ✓ **No film waste** – with motorized Pre-Stretch system & independent tension control
- ✓ **Increased production capacity** – thanks to customized settings
- ✓ **Strong construction** – 2,4T load capacity for less effort in maintenance and flat operating cost
- ✓ **Flexibility** – machine easy to move with forklift (also after installation)
- ✓ **Customized programs** – infinitely customizable programs with advanced settings.
- ✓ **Easy-to-use** – due to the simple control concept
- ✓ **Modular system** – meeting your individual needs
- ✓ **Easy installation** – delivered with hinged column already mounted
- ✓ **CE compliant** - engineered and produced in Italy according to EU safety standards

DIMENSIONS

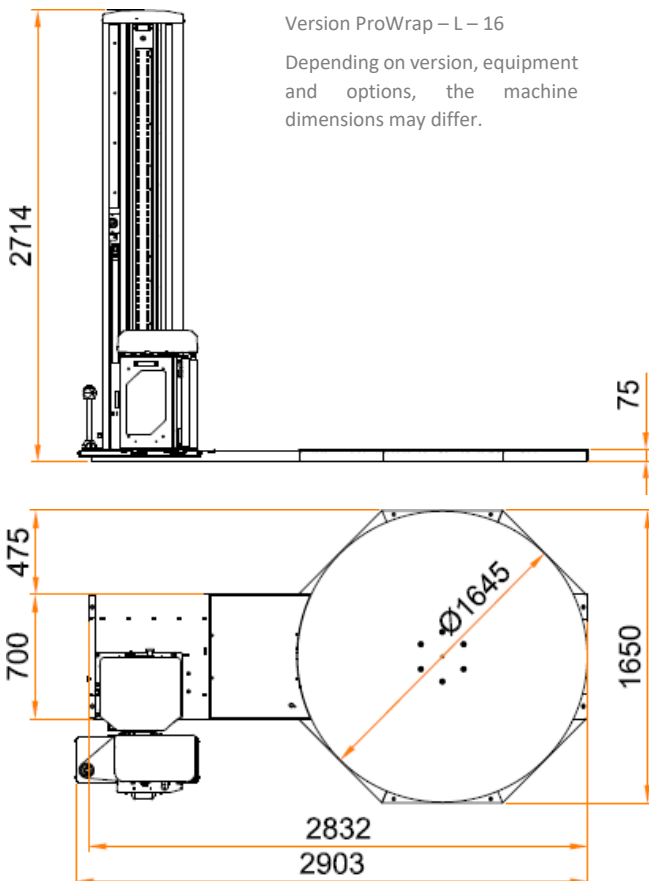

TOUCH SCREEN DISPLAY



- 7" touch screen control panel with different operating modes
- 12 customizable programs & infinite library on Siat OptiRun
- Semi-automatic and manual working mode
- Individual Speeds for Up/Down carriage movement and turntable speed
- Separated set-up for top and bottom reinforcement loops and advanced settings menu
- Emergency push-button according to regulations

OPTIRUN - SYSTEM

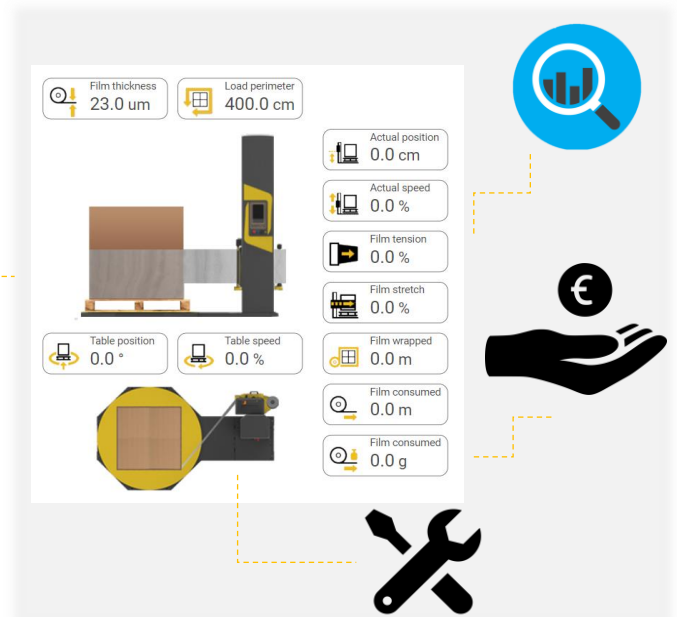

OPTIRUN | DESCRIPTION

OptiRun is a Remote Monitoring System with real-time monitoring of machine performance including tracking film usage for every pallet and remote maintenance.

The user can interact with the machine in remote mode on any device (PC, tablet or smartphone).

Developed in accordance with Industry 4.0 concept, **OptiRun** guarantees saving of resources and time as well as the total control of machine productivity, working time and film consumption.

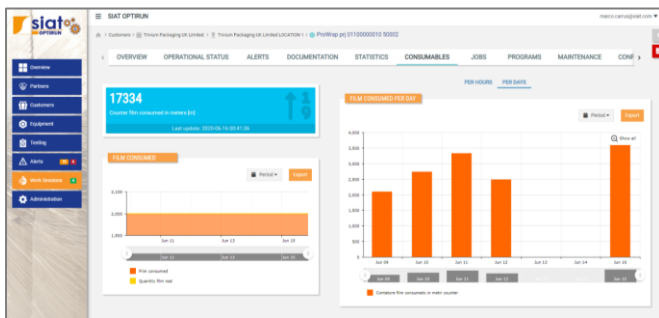

OPTIRUN | KEY-FEATURES

- **Machine overview and operational status** – gives an instant view of machine dashboard and instantaneous parameters, power-on time and operating time, active alerts and alerts history.
- **Statistics** – access to pallet counter for started and completed cycles, alert counter and details.
- **Stretch Film Measurement** – measures film consumed in meters and grams per pallet and per day.
- **Programs library and counter** – ability to store and export programs. Monitors average duration and average film consumed per program.
- **Maintenance & Configuration** – possibility to check platform motor frequency, film tension and temperature trend. Access to predictive maintenance and service advice to reduce down time.
- **Documentation** – easy access to machine user manual.

OPTIRUN | REMOTE SERVICE PACKAGES

| Type of Package / Type of Service | SIAT Remote Basic | SIAT OptiRun |
|--|-------------------|--------------|
| Customer dashboards* | • | • |
| E-mail Alerts through SIAT Tickets | • | • |
| Customer Reports | • | • |
| Remote Fault Diagnostics* | | • |
| Dedicated telephone number | | • |
| Identification of parts necessary for the assistance | | • |
| Problem Resolution | | • |
| Scheduled appointment | | • |
| Priority response | | 24 H |
| Classification of the issue | | • |
| Consumable (film/tape) consumption visualization** | • | • |
| Consumable (film/tape) consumption reporting** | | • |

* In case of machine not equipped with a cloud SERVICE, SIAT offers remote connection via previously arranged video calls or augmented reality.

** where applicable

ProWrap

DATASHEET

SPECIAL VERSIONS & OPTIONS

CW / CWS VERSION

ProWrap CW & CWS models are equipped with an Automatic, Cut & Wipe system (CW) and additional Sealing system (CWS) to allow automatic cut, wipe and weld of the stretchfilm. This eliminates film tails and reduces operator intervention.

Only suitable for regular shaped pallets where the products have flat surfaces and are flush with the pallet edge.

Both CW & CWS Version require a pneumatic air supply with:

- Operating pressure of 6 Bar (Min)
- Minimum Air flow of 1300NI/min
- Air quality acc. to standard ISO 8753-1:2010 in class 7-4-4

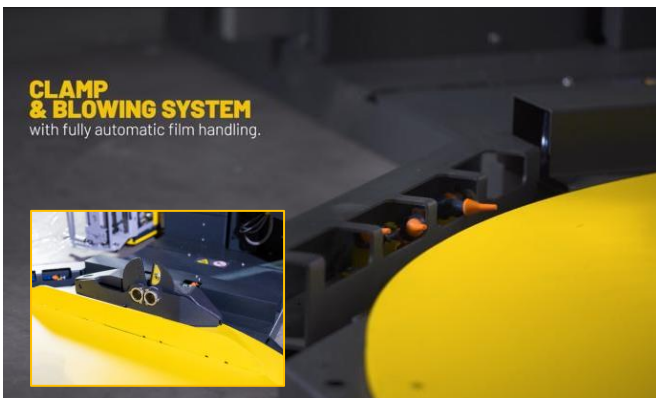
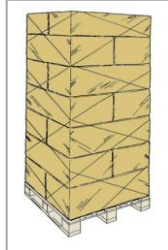

PRESSING UNIT

The optional pressing unit allows safe and consistent wrapping of lightweight loads. The Press controls are independent from other parameter/programs.



| Air consumption | |
|-----------------|------------|
| Pallet height | NL / cycle |
| 2.200 mm | 9 |
| 2.600 mm | 12 |
| 3.000 mm | 14 |



ROPING SYSTEMS

Two **roping** configurations are available on the ProWrap range. Roping reduces the width of film to a narrow band improving load stability and reducing film consumption:

- Roping from top of carriage: full roping (electrical system) to fix your product to the pallet with a narrow cord. The end of the cycle is carried out with the full band.
- Roping from bottom of carriage: partial roping reducing film width to a band (pneumatic system) to give more stability while saving film. Available only in combination with roping from top.



AREA LASER SCAN

The laser scan is an alternative to safety fences. It is used on the CW / CWS models as they both have moving parts (welding arm) which could injure intruders Laser scan helps protect personnel and is compliant to CE Regulations.

Thanks to its 3 alarm zones and cutting-edge software, the machine can calculate a safe distance and immediately stop if a zone is entered.

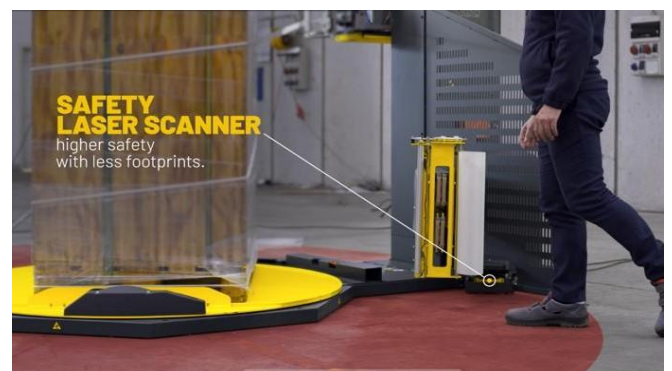
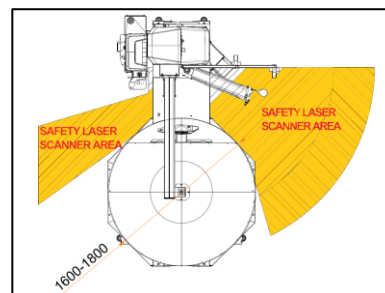

DATASHEET

| Carriage type | DM | PW | FM |
|---|---|----------------------|------------------------|
| Description | Double Motor | Powered Pre-Stretch | Electro-Magnetic Brake |
| Pre-Stretch level (%) | up to 400 | 100 – 350 (200 std.) | - |
| Platform diameter (mm) | 1.650 std. / 1.800 / 2.200 / 1.650 HS (open turntable) | | |
| Max. pallet height (mm) incl. overlap above pallet top edge | 2.200 std. (Low) / 2.600 (Medium) / 3.000 (High) | | |
| Max. pallet size (mm) | 1.000 x 1.200 - 1.550 x 1.550 (depending on turntable diam.) | | |
| Max. working load (kg) | 2.400 std. (flat turntable) / 1.200 HS (open turntable) | | |
| Power supply | 220/240V 50/60Hz / 400V 50/60Hz / others on request | | |
| Platform rotation speed | 6 – 12 rpm (adjustable) | | |
| Max. noise level | 72,0 dB(A) | | |
| Operating temperature | 5 – 40°C | | |
| Film roll details (max.) | width 500 mm / ext. Ø 300 mm / core Ø 76mm (fix) / weight 20 kg / thickness up to 35 micron | | |

OPTIONS & ACCESSORIES

- Photocell for dark or reflective surfaces
- Standard ramp; L=1.490mm
- Elongated ramp; L=1.870mm (for loading with pallet truck)
- Open turntable - "Horse-Shoe-Version" with possible loading from 3 sides
- Pit-frame for installation at ground level
- Film cutting punch (for PW & DM carriage)
- Weighing system with control keyboard
- Low temperature version (-20° C)
- PW carriage for film rolls with 750mm height
- Safety Fences

| Features | DM | PW | FM |
|--|----|----|----|
| Manual + 4 Automatic modes | • | • | • |
| 12 individual programs | • | • | • |
| Pre-Stretch system | • | • | - |
| Adjustable film tension from control panel | • | • | • |
| Adjustable Pre-Stretch from control panel | • | - | - |
| Smooth Start / Stop | • | • | • |
| Independent setting of rotation & carriage speeds | • | • | • |
| Lockable Control Panel | • | • | • |
| Top-Sheet function | • | • | • |
| No. of Top- & Bottom windings (independent settable) | • | • | • |
| Automatic height detection | • | • | • |
| Top edge overlap (settable from control-panel) | • | • | • |
| Adjustable bottom overlap | • | • | • |
| Auto. film break detection | • | • | - |
| Pausable wrapping cycle | • | • | • |
| Individual section definition with settable parameters | • | • | • |

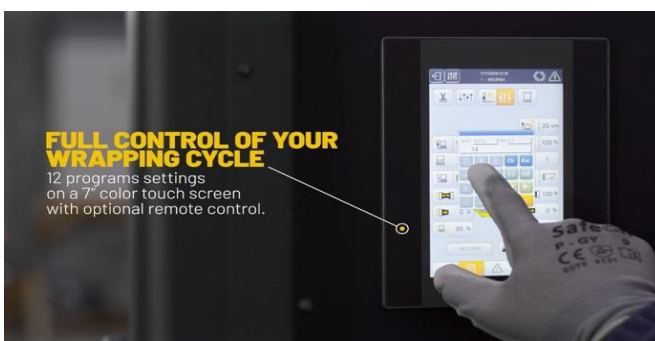

FILM CARRIAGES



MORE DETAILS

Videos and further information can be found on our website or SIAT Youtube channel.



SAFE • STRONG • SMART

Ubro-systempac.dk