

PacDrive 3 automation solution

PacDrive LMC motion controllers
(LMC Eco/Pro/Pro2)

Catalog

March 2016



How can you fit a 6000-page catalog in your pocket?

Schneider Electric provides you with the complete set of industrial automation catalogs all on a handy USB key for PC or in an application for tablets



Digi-Cat, a handy USB key for PC



- > Convenient to carry
- > Always up-to-date
- > Environmentally friendly
- > Easy-to-share format

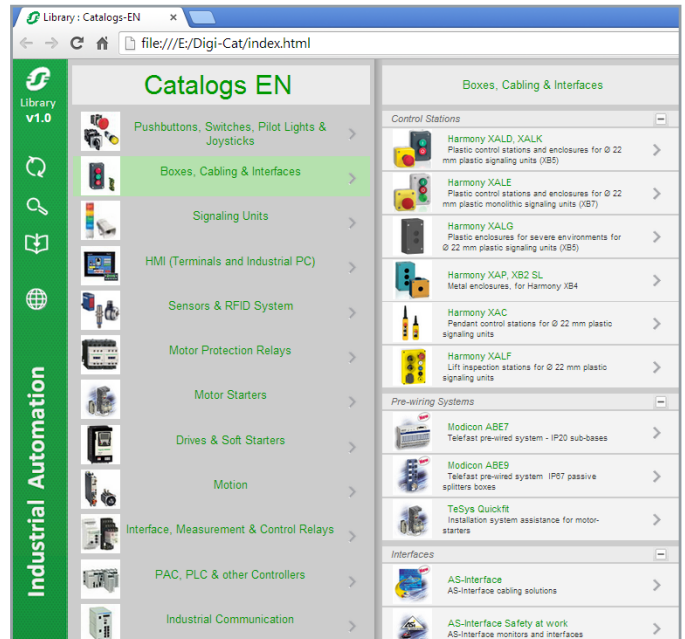

Contact your local representative to get your own Digi-Cat



e-Library, the app for tablets

If you have an iPad®:

- > Go to the App Store and search for e-Library
- > or scan the QR code



If you have an Android tablet:

- > Go to the Google Play Store™ and search for eLibrary
- > or scan the QR code

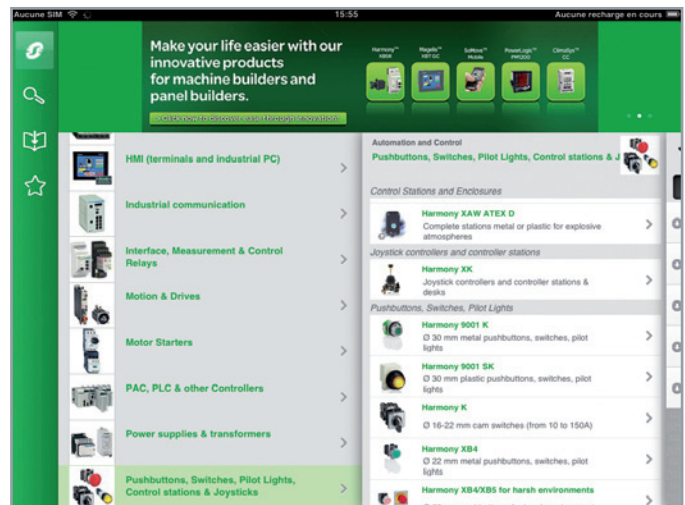

General contents

PacDrive 3 automation solution

PacDrive LMC motion controllers (LMC Eco/Pro/Pro2)

■ **Presentation**

- Scalable performance for high-performance industrial machines *page 2*
- Ethernet-based communication with Sercos..... *page 3*

■ **PacDrive LMC Eco/Pro/Pro2 controllers**

- Range overview *page 4 and 5*
- Characteristics *page 6*
- Description *page 7*
- Type code *page 8*

■ **References**

- PacDrive LMC Eco controllers *page 9*
 - Spare parts, communication modules, programming software *page 9*
- PacDrive LMC Pro controllers..... *page 10*
 - Spare parts, programming software..... *page 10*
- PacDrive LMC Pro2 controllers..... *page 11*
 - Spare parts, programming software..... *page 11*
- Cables, terminals *page 11*
- Robot controllers *page 12*

- **Index** *page 14*



PacDrive LMC motion controllers



Memory card

Controls

Scalable performance for high-performance industrial machines

PacDrive LMC motion controllers cover a wide range of applications.

> Full software compatibility

PacDrive LMC motion controllers are a broad family of eleven different controllers, with a powerful CPU for applications requiring 0 to 130 synchronized axes (at 1 msec network update rate)

- up to 130 servo axes, and up to 255 virtual axes
- with multiple fieldbuses used in parallel to Sercos: CANopen, Profibus DP, etc.

All controllers are software-compatible, thanks to SoMachine Motion programming software, a Logic Motion Runtime software:

- same runtime
- same libraries
- same engineering tool
- same diagnostic tools
- same support of drives, IOs, etc.

Up to 4096 dynamic electronic cam disks can be programmed to operate in parallel. The program can switch between electronic cam disks during operation. All controllers have an integrated PLC (5 µsec for 1000-bit instructions).

> Benefits for you and your customers

- **Diagnostics functionalities included:** integrated software oscilloscope and message logger
- **Outstanding performance:** powerful motion engine
- **Connectivity:** broad support of fieldbuses and IT communication protocols
- **Service-oriented:** memory card for storing/transferring programming and configuration data
- **Easy to service:** no PC required, integrated plaintext display in five languages for system messages and diagnostics

sercos
the automation bus

Controls

Ethernet-based communication with Sercos

Sercos is the preferred automation bus for PacDrive:

- Drive communication
- I/O communication
- Safe communication and non realtime IP communication
- All embedded in one cable

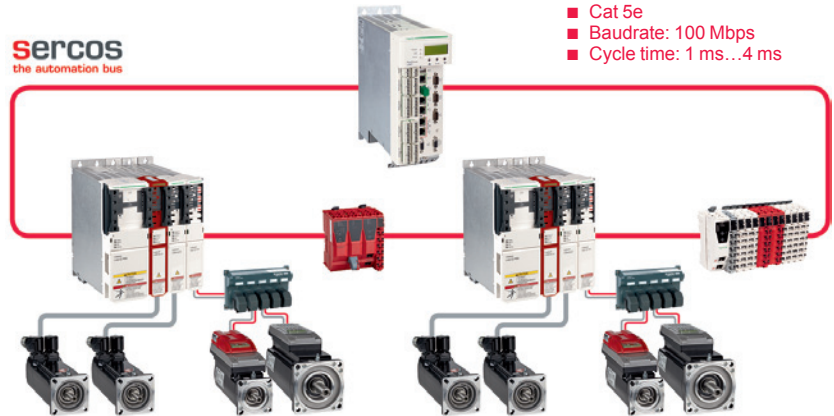

> Key benefits of Sercos for PacDrive

- **Universal:** fully integrated Ethernet-based solution for drive, fieldbus, and safety communication
- **Reliable:** media redundancy to reduce probability of failure
- **Powerful:** network update rate of 1...4 ms for 130 servo axes. Less than 100 ns jitter
- **Cost-effective:** simple, no hub or switches, Cat 5e cable is generally sufficient
- **High availability:** Sercos supports all PacDrive functions for automating the setup of servo drives/motors, including assignment of bus address
- **Vendor-neutral:** supported by more than 50 controller manufacturers and 30 drive manufacturers
- **Green:** Sercos energy profile defines rules for creating standardized energy modes

> Flexible I/O design with standard and safe I/O

The modular Schneider Electric Modicon TM5 (1) and Modicon TM7 (1) systems for Sercos provide I/O technology with IP 20 and IP 67 protection. Safe communication versions of both TM5 and TM7 safety modules are available, color-coded to clearly differentiate them from standard technology. Standard and safe I/O modules can be mixed.

> Connectivity

- In addition to the Sercos automation bus, PacDrive LMC motion controllers support the following communication standards:
 - Fieldbuses:
 - Profinet
 - Profibus DP
 - CAN
 - EtherNet/IP
 - EtherCat
 - Modbus TCP
 - IT protocols:
 - TCP/IP
 - UDP/IP
 - OPC UA
 - FTP
 - HTTP (embedded web visualization)
 - Serial communication:
 - USB / serial interface
- Optional expansion cards are also available for all controllers to implement additional fieldbus interfaces such as EtherNet/IP. USB and serial interfaces are also standard in all controllers. The PacDrive LMC controllers also have a Profibus DP interface (Master and Slave).

(1) For more information, Please refer to our catalogs: "Modicon TM5, expansion modules", "Pacdrive 3 Safety Modicon TM5-TM7", and "Modicon TM7, IP 67 modular I/O system".



PacDrive 3 automation solution

PacDrive LMC motion controllers
PacDrive LMC Eco/Pro/Pro2 controllers

Motion controller type	PacDrive LMC Eco						PacDrive LMC Pro			PacDrive LMC Pro2	
	LMC100	LMC101	LMC106	LMC201	LMC212	LMC216	LMC300	LMC400	LMC600	LMC402	LMC802



Processor	Intel Atom 1.6 GHz 512 KB L2 Cache	Intel Celeron M 1.5 GHz 512 KB L2 Cache	Intel Celeron M 1.5 GHz 1 MB L2 Cache	Intel Pentium M 2 GHz 2 MB L2 Cache	Intel Celeron 2000E 2.2 GHz 2 MB Smart Cache	Intel Celeron 2000E 2.2 GHz 2 MB Smart Cache
RAM	512 MB DDR2 RAM	512 MB DDR2 RAM	512 MB DDR2 RAM	256 KB	1 GB DDR3L	2 MB Smart Cache
NV RAM	128 KB				256 KB	
Power supply	Supply voltage 24 VDC Supply consumption 30 W	24 VDC 36 W	24 VDC 36 W	24 VDC 36 W	24 VDC 36 W	24 VDC 36 W
Battery	Yes	Yes	Yes	Yes	Yes	Yes
Memory card	At least 512 MB (SD Card)	At least 128 MB (CF Card)	At least 128 MB (CF Card)	At least 128 MB (CF Card)	At least 128 MB (CF Card)	At least 128 MB (CF Card)
Cooling	Passive	Fan	Fan	Fan	Fan	Fan
Real-Time Clock (RTC)	Yes	Yes	Yes	Yes	Yes	Yes
Real-Time Operating System	VxWorks and SEAAutomation Kernel	VxWorks and SEAAutomation Kernel	VxWorks and SEAAutomation Kernel	VxWorks and SEAAutomation Kernel	VxWorks and SEAAutomation Kernel	VxWorks and SEAAutomation Kernel
Input	Digital input 8 Touchprobe input 4 Interrupt input - Analog input -	20 16 4 2	20 16 4 2	20 16 4 2	20 16 4 2	20 16 4 2
Output	Digital output 8 Analog output -	16 2	16 2	16 2	16 2	16 2
Number of drives	0 servo axes 4 servo axes 6 servo axes 8 servo axes 12 servo axes 16 servo axes	8 servo axes 16 servo axes	16 servo axes 99 servo axes	99 servo axes	16 servo axes 130 servo axes	130 servo axes
Integrated communication	CAN 1 (9 pin SUB-D plug x1) RS232 1 (RJ45 x1) RS422/RS485 1 (RJ45 x1) USB-A 1 (USB x1) Profibus DP-DP - Master encoder 1 (RJ45 x1) Ethernet 1 (RJ45 x1) Realtime Ethernet - Sercos 1 (RJ45 x2) PacNet -	1 (9 pin SUB-D plug x1) 1 (9 pin SUB-D plug x1) 1 (9 pin SUB-D plug x1) 1 (9 pin SUB-D plug x1) 1 (USBx1) 1 (9 pin SUB-D socket x1) 1 (9 pin SUB-D socket x1) 1 (RJ45 x1) 1 (RJ45 x2) 1 (RJ45 x2) 1 (RJ45 x1)	1 (9 pin SUB-D plug x1) 1 (9 pin SUB-D plug x1) 1 (9 pin SUB-D plug x1) 1 (9 pin SUB-D plug x1) 1 (USBx1) 1 (9 pin SUB-D socket x1) 1 (9 pin SUB-D socket x1) 1 (RJ45 x1) 1 (RJ45 x2) 1 (RJ45 x2) 1 (RJ45 x1)	1 (9 pin SUB-D plug x1) 1 (9 pin SUB-D plug x1) 1 (9 pin SUB-D plug x1) 1 (9 pin SUB-D plug x1) 1 (USBx1) 1 (9 pin SUB-D socket x1) 1 (9 pin SUB-D socket x1) 1 (RJ45 x1) 1 (RJ45 x2) 1 (RJ45 x2) 1 (RJ45 x1)	1 (9 pin SUB-D plug x1) 1 (9 pin SUB-D plug x1) 1 (9 pin SUB-D plug x1) 1 (9 pin SUB-D plug x1) 1 (USBx1) 1 (9 pin SUB-D socket x1) 1 (9 pin SUB-D socket x1) 1 (RJ45 x1) 1 (RJ45 x2) 1 (RJ45 x2) 1 (RJ45 x1)	1 (9 pin SUB-D plug x1) 1 (9 pin SUB-D plug x1) 1 (9 pin SUB-D plug x1) 1 (9 pin SUB-D plug x1) 1 (USBx1) 1 (9 pin SUB-D socket x1) 1 (9 pin SUB-D socket x1) 1 (RJ45 x1) 1 (RJ45 x2) 1 (RJ45 x2) 1 (RJ45 x1)

PacDrive 3 automation solution

PacDrive LMC motion controllers

PacDrive LMC Eco/Pro/Pro2 controllers

Motion controller type		PacDrive LMC Eco	PacDrive LMC Pro	PacDrive LMC Pro2
		LMC100, LMC101, LMC106, LMC201, LMC212, LMC216	LMC300, LMC400, LMC600	LMC402, LMC802
Integrated I/O				
Touchprobe input	Number	4	16	16
	Nominal input voltage	24 VDC	24 VDC	24 VDC
	Input filter	100 µs	100 µs	100 µs
	TP0 to TP15	10 µs	10 µs	10 µs
Digital input	Number	8	20	20
	Nominal input voltage	24 VDC	24 VDC	24 VDC
	Input filter	–	1 or 5 ms (can be parameterized)	1 or 5 ms (can be parameterized)
Interrupt input	Number	–	4	4
	Nominal input voltage	–	24 VDC	24 VDC
	Input filter	–	0.1 or 1 ms (can be parameterized)	0.1 or 1 ms (can be parameterized)
Analog input	Number	–	2	2
	Type	–	Voltage/current	Voltage/current
	Range	–	- 10...10 V (resistor 100 kOhm) - 20...20 mA	- 10...10 V (resistor 100 kOhm) - 20...20 mA
	Resolution	–	12 bits	12 bits
Digital output	Number	8	16	16
	Output voltage	24 VDC	24 VDC	24 VDC
	Nominal current (I _e)	100 mA per output	250 mA per output	250 mA per output
	Transmission time	100 µs	100 µs	100 µs
	Short-circuit protection	Yes	Yes	Yes
Analog output	Number	–	2	2
	Type	–	Voltage	Voltage
	Range	–	-10...10 V	-10...10 V
	Resolution	–	12 bits	12 bits
Communication				
Bus connections	Integrated motion bus	Sercos	Sercos	Sercos
	Integrated additional fieldbus connection (configuration 1)	CANopen (Master/Slave)	Profibus DP Master/Slave and CANopen (2.0B)	Profibus DP Master/Slave and CANopen (2.0B)
	Integrated additional fieldbus connection (configuration 2)	–	RT-Ethernet (2 ports) and Profibus DP (Master/Slave) or CANopen (2.0B)	RT-Ethernet (2 ports) and Profibus DP (Master/Slave) or CANopen (2.0B)
	PacNet interface	–	1	1
Communication/interface	Serial interfaces	COM1: RS232 COM2: RS422/RS485	COM1: RS232 COM2: RS422/RS485	COM1: RS232 COM2: RS422/RS485
	Network connection	1x Ethernet 10/100 BASE-T	1x Ethernet 10/100 BASE-T	1x Ethernet 10/100/1000 BASE-T
	USB connection	1x USB-A-2.0	1x USB-A-2.0	1x USB-A-2.0
	Master encoder interface	1x Hiperface® master encoder or 1x incremental master encoder	1x Hiperface® master encoder or 1x incremental master encoder	1x Hiperface® master encoder or 1x incremental master encoder
	Programming interface	Ethernet	Ethernet	Ethernet
	Additional encoder input via PacNet interface	–	Up to 4 Hiperface encoder inputs and up to 8 incremental master encoder outputs	Up to 4 Hiperface encoder inputs and up to 8 incremental master encoder outputs
	Master encoder output via PacNet interface	–	Up to 4x incremental master encoder outputs	Up to 4x incremental master encoder outputs
	Integrated OPC interface	OPC-UA Server	OPC-UA Server	OPC-UA Server
	Diagnostic interface for remote maintenance	Ethernet or Modem	Ethernet or Modem	Ethernet or Modem
	Communication protocols	HTTP (Hypertext Transfer Protocol) FTP (File Transfer Protocol)	HTTP (Hypertext Transfer Protocol) FTP (File Transfer Protocol)	HTTP (Hypertext Transfer Protocol) FTP (File Transfer Protocol)
	Communication modules	1 Option module	Up to 2 Option modules	Up to 2 Option modules
		<ul style="list-style-type: none"> ■ RT-Ethernet □ Profinet IO-RT (Controller) □ EtherNet/IP (Scanner / Adapter) □ EtherCAT IO (Master/Slave) ■ Profibus DP (Master/Slave) 	<ul style="list-style-type: none"> ■ CANopen ■ Profibus DP ■ RT-Ethernet □ Profinet IO-RT (Controller) □ EtherNet/IP (Scanner / Adapter) □ EtherCAT IO (Master/Slave) ■ RT-Ethernet x2 ■ RT-Ethernet and CANopen ■ RT-Ethernet and Profibus DP 	<ul style="list-style-type: none"> ■ CANopen ■ Profibus DP ■ RT-Ethernet □ Profinet IO-RT (Controller) □ EtherNet/IP (Scanner / Adapter) □ EtherCAT IO (Master/Slave) ■ RT-Ethernet x2 ■ RT-Ethernet and CANopen ■ RT-Ethernet and Profibus DP

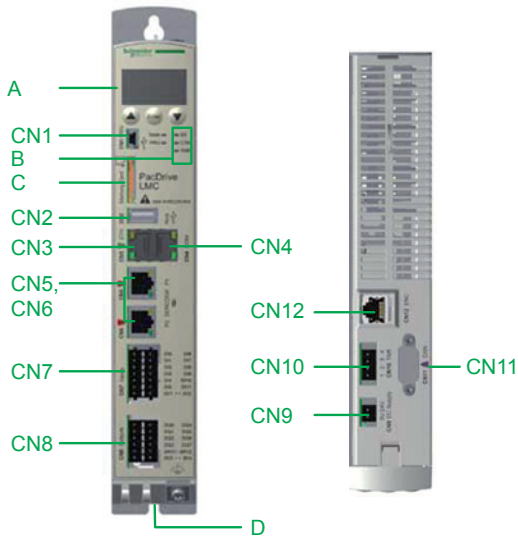

PacDrive LMC Eco controller – description

LMC100, LMC101, LMC106, LMC201, LMC212, LMC216

Item	Function
A	LCD and LED
B	LED connector
C	SD card
D	Optional module slots
CN1	USB client (not active)
CN2	USB Host
CN3	Ethernet
CN4	COM: RS232/RS485
CN5, CN6	Sercos
CN7	12 digital input and 4 touchprobe input
CN8	8 digital output
CN9	24 VDC power supply
CN10	Not active
CN11	CAN/CANopen
CN12	Master encoder

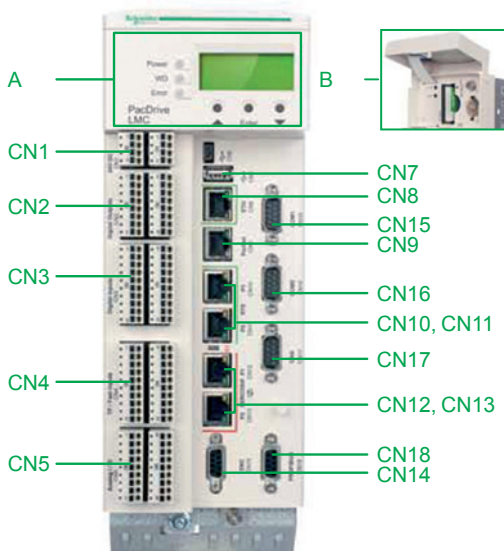

PacDrive LMC Pro and Pro2 controller – description

LMC300, LMC400, LMC600, LMC402, LMC802

Item	Function
A	LCD and LED
B	CF card and battery
CN1	24 VDC power supply and Watchdog
CN2	16 digital output
CN3	20 digital input
CN4	16 touchprobe input and 4 fast input
CN5	2 analog input and 2 analog output
CN7	USB host
CN8	Ethernet
CN9	PacNet
CN10, CN11	RT-Ethernet
CN12, CN13	Sercos
CN14	Master encoder
CN15	COM1: RS232
CN16	COM2: RS422/RS485
CN17	CANopen
CN18	Profibus DP

PacDrive LMC Eco/Pro/Pro 2 controllers – type code

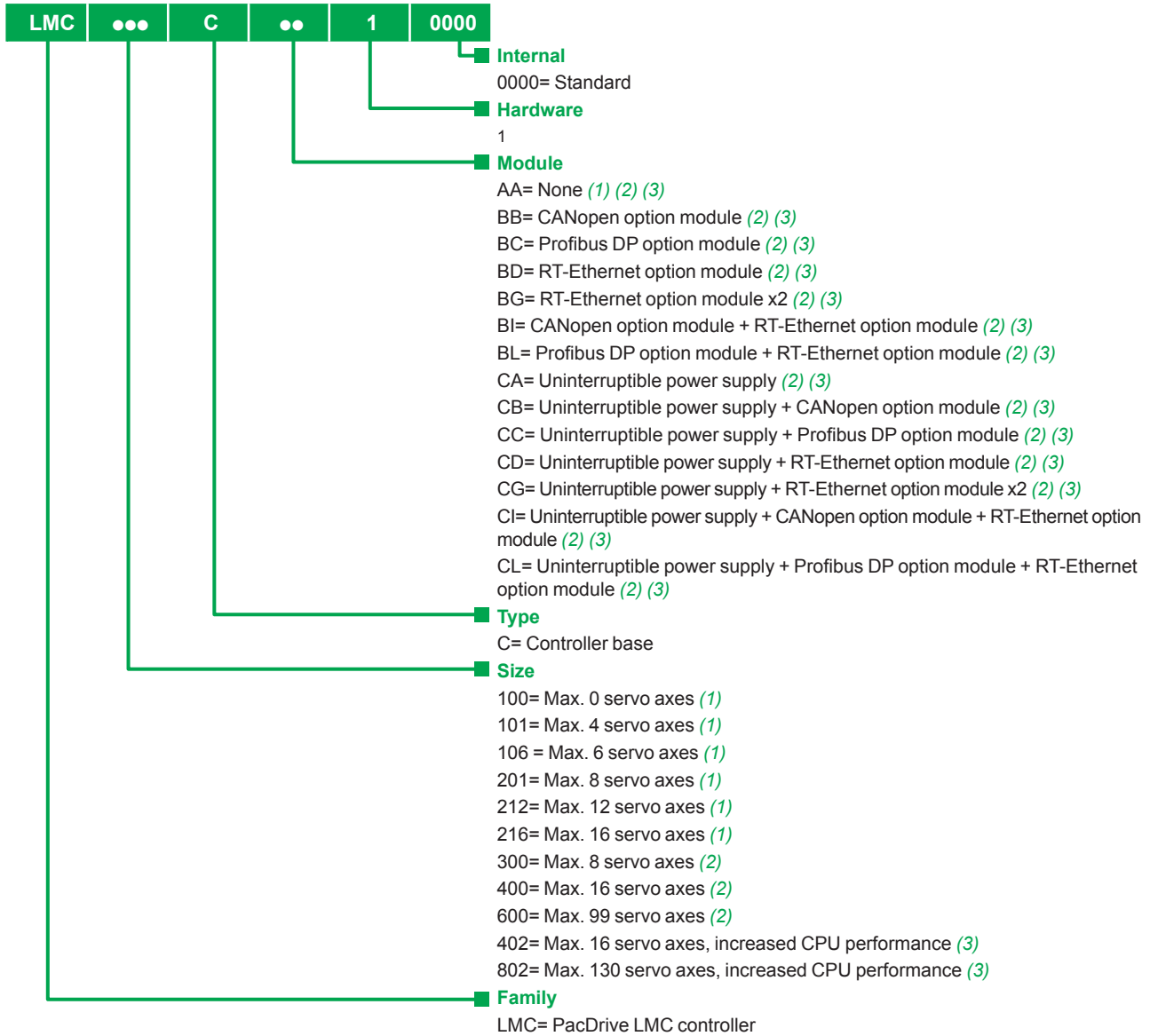

(1) For PacDrive LMC Eco controllers.
 (2) For PacDrive LMC Pro controllers.
 (3) For PacDrive LMC Pro2 controllers.



PacDrive LMC Eco controller

PacDrive LMC Eco controllers – references

Size	Max. number of controlled servo axes	Options	Reference	Weight kg/lb
LMC100	0	– (basic)	LMC100CAA10000	2.200/ 4.85
LMC101	4	– (basic)	LMC101CAA10000	
LMC106	6	– (basic)	LMC106CAA10000	
LMC201	8	– (basic)	LMC201CAA10000	
LMC212	12	– (basic)	LMC212CAA10000	
LMC216	16	– (basic)	LMC216CAA10000	

Nota: Accessory kit included in controller packaging as described below.



VW3E704000000



VW3E704100000

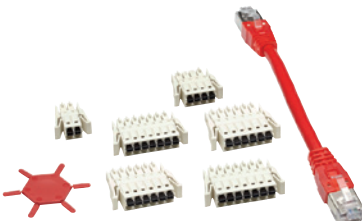

VW3E6019



VW3E70360AA00

Spare parts for PacDrive LMC Eco controllers – references

Communication modules

Designation	Description	Reference	Weight kg/lb
Communication module Profibus DP	1x 9 pin SUB-D	VW3E704000000	0.080/ 0.18
Communication module Ethernet real time (RT)	2x RJ45 ports	VW3E704100000	0.080/ 0.18

Spare parts

Designation	Description	Reference	Weight kg/lb
Accessory kit	Complete connector set for PacDrive LMC Eco controllers (100C...216C) and Sercos cable (0.13 m / 0.43ft)	VW3E6019	0.100/ 0.22
SD card	512 MB	VW3E70360AA00	0.025/ 0.06

Programming software

SoMachine Motion software for PacDrive LMC Eco controllers *Please refer to our catalog "SoMachine - PacDrive 3 Automation solution, SoMachine Motion software".*

PacDrive 3 automation solution

PacDrive LMC motion controllers

PacDrive LMC Pro controllers



PacDrive LMC Pro controller

PacDrive LMC Pro controllers – references							
Size	Max. number of controlled servo axes	Options	Reference	Weight kg/lb			
LMC300	8	– (basic)	LMC300CAA10000	3.500/ 7.72			
		CANopen option module	LMC300CBB10000				
		Profibus DP option module	LMC300CBC10000				
		RT-Ethernet option module	LMC300CBD10000				
		2x RT-Ethernet option modules	LMC300CBG10000				
		1x CANopen option module + 1x RT-Ethernet option module	LMC300CBI10000				
		1x Profibus DP option module + 1x RT-Ethernet option module	LMC300CBL10000				
		Uninterruptible power supply	LMC300CCA10000				
		CANopen option module + Uninterruptible power supply	LMC300CCB10000				
		Profibus DP option module + Uninterruptible power supply	LMC300CCC10000				
		RT-Ethernet option module + Uninterruptible power supply	LMC300CCD10000				
		2x RT-Ethernet option modules + Uninterruptible power supply	LMC300CCG10000				
		1x CANopen option module + 1x RT-Ethernet option module + Uninterruptible power supply	LMC300CCI10000				
		1x Profibus DP option module + 1x RT-Ethernet option module + Uninterruptible power supply	LMC300CCL10000				
		LMC400	16		– (basic)	LMC400CAA10000	3.500/ 7.72
					CANopen option module	LMC400CBB10000	
Profibus DP option module	LMC400CBC10000						
RT-Ethernet option module	LMC400CBD10000						
2x RT-Ethernet option modules	LMC400CBG10000						
1x CANopen option module + 1x RT-Ethernet option module	LMC400CBI10000						
1x Profibus DP option module + 1x RT-Ethernet option module	LMC400CBL10000						
Uninterruptible power supply	LMC400CCA10000						
CANopen option module + Uninterruptible power supply	LMC400CCB10000						
Profibus DP option module + Uninterruptible power supply	LMC400CCC10000						
RT-Ethernet option module + Uninterruptible power supply	LMC400CCD10000						
2x RT-Ethernet option modules + Uninterruptible power supply	LMC400CCG10000						
1x CANopen option module + 1x RT-Ethernet option module + Uninterruptible power supply	LMC400CCI10000						
1x Profibus DP option module + 1x RT-Ethernet option module + Uninterruptible power supply	LMC400CCL10000						
LMC600	99			– (basic)	LMC600CAA10000	3.500/ 7.72	
				CANopen option module	LMC600CBB10000		
		Profibus DP option module	LMC600CBC10000				
		RT-Ethernet option module	LMC600CBD10000				
		2x RT-Ethernet option modules	LMC600CBG10000				
		1x CANopen option module + 1x RT-Ethernet option module	LMC600CBI10000				
		1x Profibus DP option module + 1x RT-Ethernet option module	LMC600CBL10000				
		Uninterruptible power supply	LMC600CCA10000				
		CANopen option module + Uninterruptible power supply	LMC600CCB10000				
		Profibus DP option module + Uninterruptible power supply	LMC600CCC10000				
		RT-Ethernet option module + Uninterruptible power supply	LMC600CCD10000				
		2x RT-Ethernet option modules + Uninterruptible power supply	LMC600CCG10000				
		1x CANopen option module + 1x RT-Ethernet option module + Uninterruptible power supply	LMC600CCI10000				
		1x Profibus DP option module + 1x RT-Ethernet option module + Uninterruptible power supply	LMC600CCL10000				

Nota: Accessory kit included in controller packaging as described below.



VW3E6004



VW3E70350AA00

Spare parts for PacDrive LMC Pro controllers – references

Spare parts			
Designation	Description	Reference	Weight kg/lb
Accessory kit	Complete connector set for PacDrive LMC Pro/Pro2 controllers and Sercos cable (0.13 m / 0.43ft)	VW3E6004	0.100/ 0.22
Compact flash memory card	512 MB	VW3E70350AA00	0.025/ 0.06
Battery	Lithium battery front, 3 V	VW3E6020	0.060/ 0.13

Programming software

SoMachine Motion software PacDrive LMC Pro controllers	<i>Please refer to our catalog "SoMachine - PacDrive 3 Automation solution, SoMachine Motion software".</i>
---	---

PacDrive 3 automation solution

PacDrive LMC motion controllers

PacDrive LMC Pro2 controllers



PacDrive LMC Pro2 controller

PacDrive LMC Pro2 controllers – references							
Size	Max. number of controlled servo axes	Options	Reference	Weight kg/lb			
LMC402	16	– (basic)	LMC402CAA10000	3.500/ 7.72			
		CANopen option module	LMC402CBB10000				
		Profibus DP option module	LMC402CBC10000				
		RT-Ethernet option module	LMC402CBD10000				
		2x RT-Ethernet option modules	LMC402CBG10000				
		1x CANopen option module + 1x RT-Ethernet option module	LMC402CBI10000				
		1x Profibus DP option module + 1x RT-Ethernet option module	LMC402CBL10000				
		Uninterruptible power supply	LMC402CCA10000				
		CANopen option module + Uninterruptible power supply	LMC402CCB10000				
		Profibus DP option module + Uninterruptible power supply	LMC402CCC10000				
		RT-Ethernet option module + Uninterruptible power supply	LMC402CCD10000				
		2x RT-Ethernet option modules + Uninterruptible power supply	LMC402CCG10000				
		1x CANopen option module + 1x RT-Ethernet option module + Uninterruptible power supply	LMC402CCI10000				
		1x Profibus DP option module + 1x RT-Ethernet option module + Uninterruptible power supply	LMC402CCL10000				
		LMC802	130		– (basic)	LMC802CAA10000	3.500/ 7.72
					CANopen option module	LMC802CBB10000	
Profibus DP option module	LMC802CBC10000						
RT-Ethernet option module	LMC802CBD10000						
2x RT-Ethernet option modules	LMC802CBG10000						
1x CANopen option module + 1x RT-Ethernet option module	LMC802CBI10000						
1x Profibus DP option module + 1x RT-Ethernet option module	LMC802CBL10000						
Uninterruptible power supply	LMC802CCA10000						
CANopen option module + Uninterruptible power supply	LMC802CCB10000						
Profibus DP option module + Uninterruptible power supply	LMC802CCC10000						
RT-Ethernet option module + Uninterruptible power supply	LMC802CCD10000						
2x RT-Ethernet option modules + Uninterruptible power supply	LMC802CCG10000						
1x CANopen option module + 1x RT-Ethernet option module + Uninterruptible power supply	LMC802CCI10000						
1x Profibus DP option module + 1x RT-Ethernet option module + Uninterruptible power supply	LMC802CCL10000						

Nota: Accessory kit included in controller packaging as described below.



VW3E6004



VW3E7037000000

Spare parts for PacDrive LMC Pro2 controllers – references

Spare parts			
Designation	Description	Reference	Weight kg/lb
Accessory kit	Complete connector set for PacDrive LMC Pro/Pro2 controllers and Sercos cable (0.13 m/ 0.43ft)	VW3E6004	0.100/ 0.22
Compact flash memory card	512 MB	VW3E7037000000	0.025/ 0.06
Battery	Lithium battery front, 3 V	VW3E6020	0.060/ 0.13

Programming software

SoMachine Motion software for PacDrive LMC Pro2 controllers	<i>Please refer to our catalog "SoMachine - PacDrive 3 Automation solution, SoMachine Motion software".</i>
---	---



VW3E5001R●●●

Cables, terminals – references

Sercos cables

Designation	Length		Reference	Weight kg/lb
	m	ft		
Sercos cables for redundant Sercos ring Equipped with two RJ45 connectors	0.5	1.640	VW3E5001R005	0.045 / 0.10
	1	3.281	VW3E5001R010	0.065 / 0.14
	1.5	4.921	VW3E5001R015	0.068 / 0.15
	2	6.562	VW3E5001R020	0.081 / 0.18
	3	9.843	VW3E5001R030	0.124 / 0.27
	5	16.404	VW3E5001R050	0.199 / 0.44
	10	32.808	VW3E5001R100	0.325 / 0.72
	15	49.213	VW3E5001R150	0.610 / 1.34
	20	65.617	VW3E5001R200	0.810 / 1.79
	25	82.021	VW3E5001R250	1.020 / 2.25
	30	98.425	VW3E5001R300	1.220 / 2.69
	40	131.234	VW3E5001R400	3.100 / 6.83
	50	164.042	VW3E5001R500	2.020 / 4.45

Encoder cables

Incremental master encoder cable (UL)	1.5	4.921	VW3E2097R015	0.196 / 1.43
	5	16.404	VW3E2097R050	0.415 / 0.91
	10	32.808	VW3E2097R100	0.757 / 1.67
	15	49.213	VW3E2097R150	1.087 / 2.40
	20	65.617	VW3E2097R200	1.417 / 3.12
	30	98.425	VW3E2097R300	2.077 / 4.58
	40	131.234	VW3E2097R400	2.737 / 6.03
	50	164.042	VW3E2097R500	3.397 / 7.49

PacNet terminals

Designation	Description	Reference	Weight kg/lb
Bus terminal – 4/DIO1	PacNet bus terminal 16x digital inputs/16x digital outputs	VBO04S00	0.980 / 2.16
Bus terminal– 4/Enc1	PacNet bus terminal 2x master encoder inputs (incremental or SinCos) / 1x incremental encoder input and output	VBO05S00	0.790 / 1.74

PacNet and Patch cables (controller-Bus terminal-4) (1)

Designation	Length		Reference	Weight kg/lb
	m	ft		
PacNet cables	0.5	1.640	VW3E3001R005	0.027 / 0.06
	1	3.281	VW3E3001R010	0.054 / 0.12
	2	6.562	VW3E3001R020	0.108 / 0.24
	3	9.843	VW3E3001R030	0.162 / 0.36
	5	16.404	VW3E3001R050	0.270 / 0.60
Patch cables	10	32.808	VW3E3001R100	0.540 / 1.19
	15	49.213	VW3E3001R150	0.810 / 1.78
	20	65.617	VW3E3001R200	1.080 / 2.38
	25	82.021	VW3E3001R250	1.350 / 2.98
	30	98.425	VW3E3001R300	1.620 / 3.57
	40	131.234	VW3E3001R400	2.160 / 4.76
	50	164.042	VW3E3001R500	2.700 / 5.95

(1) PacNet cables are available only in the given lengths.



VBO04S00



VBO05S00

PacDrive 3 automation solution

PacDrive LMC motion controllers

Robot controllers



LMC101CAA●●●●●●



LMC300CAA●●●●●●



LMC400CAA●●●●●●



LMC600CAA●●●●●●

Robot controllers – references

Size	Number of synchronized servo axes	Number of license points included	Reference	Weight kg/lb
PacDrive LMC Eco robot controllers				
LMC101	up to 4	80	LMC101CAA150RC	3.500/ 7.72
LMC201	up to 8	80	LMC201CAA150RC	
		160	LMC201CAA170RC	
PacDrive LMC Pro robot controllers				
LMC300	up to 8	80	LMC300CAA150RC	3.500/ 7.72
		160	LMC300CAA170RC	
		240	LMC300CAA180RC	
		320	LMC300CAA190RC	
LMC400	up to 16	80	LMC400CAA150RC	
		160	LMC400CAA170RC	
		240	LMC400CAA180RC	
		320	LMC400CAA190RC	
LMC600	up to 99	80	LMC600CAA150RC	
		160	LMC600CAA170RC	
		240	LMC600CAA180RC	
		320	LMC600CAA190RC	
		999	LMC600CAA1D0RC	

Robot controller includes a number of license points and free support for robotics.
For details, Please refer to our catalog "SoMachine - PacDrive 3 Automation solution, SoMachine Motion software".

L			
LMC100CAA10000	9	LMC600CBI10000	10
LMC101CAA150RC	13	LMC600CBL10000	10
LMC101CAA10000	9	LMC600CCA10000	10
LMC106CAA10000	9	LMC600CCB10000	10
LMC201CAA150RC	13	LMC600CCC10000	10
LMC201CAA170RC	13	LMC600CCD10000	10
LMC201CAA10000	9	LMC600CCG10000	10
LMC212CAA10000	9	LMC600CCI10000	10
LMC216CAA10000	9	LMC600CCL10000	10
LMC300CAA150RC	13	LMC802CAA10000	11
LMC300CAA170RC	13	LMC802CBB10000	11
LMC300CAA180RC	13	LMC802CBC10000	11
LMC300CAA190RC	13	LMC802CBD10000	11
LMC300CAA10000	10	LMC802CBG10000	11
LMC300CBB10000	10	LMC802CBI10000	11
LMC300CBC10000	10	LMC802CBL10000	11
LMC300CBD10000	10	LMC802CCA10000	11
LMC300CBG10000	10	LMC802CCB10000	11
LMC300CBI10000	10	LMC802CCC10000	11
LMC300CBL10000	10	LMC802CCD10000	11
LMC300CCA10000	10	LMC802CCG10000	11
LMC300CCB10000	10	LMC802CCI10000	11
LMC300CCC10000	10	LMC802CCL10000	11
LMC300CCD10000	10		
LMC300CCG10000	10	V	
LMC300CCI10000	10	VBO04S00	12
LMC300CCL10000	10	VBO05S00	12
LMC400CAA150RC	13	VW3E2097R015	12
LMC400CAA170RC	13	VW3E2097R050	12
LMC400CAA180RC	13	VW3E2097R100	12
LMC400CAA190RC	13	VW3E2097R150	12
LMC400CAA10000	10	VW3E2097R200	12
LMC400CBB10000	10	VW3E2097R300	12
LMC400CBC10000	10	VW3E2097R400	12
LMC400CBD10000	10	VW3E2097R500	12
LMC400CBG10000	10	VW3E3001R005	12
LMC400CBI10000	10	VW3E3001R010	12
LMC400CBL10000	10	VW3E3001R020	12
LMC400CCA10000	10	VW3E3001R030	12
LMC400CCB10000	10	VW3E3001R050	12
LMC400CCC10000	10	VW3E3001R100	12
LMC400CCD10000	10	VW3E3001R150	12
LMC400CCG10000	10	VW3E3001R200	12
LMC400CCI10000	10	VW3E3001R250	12
LMC400CCL10000	10	VW3E3001R300	12
LMC402CAA10000	11	VW3E3001R400	12
LMC402CBB10000	11	VW3E3001R500	12
LMC402CBC10000	11	VW3E5001R005	12
LMC402CBD10000	11	VW3E5001R010	12
LMC402CBG10000	11	VW3E5001R015	12
LMC402CBI10000	11	VW3E5001R020	12
LMC402CBL10000	11	VW3E5001R030	12
LMC402CCA10000	11	VW3E5001R050	12
LMC402CCB10000	11	VW3E5001R100	12
LMC402CCC10000	11	VW3E5001R150	12
LMC402CCD10000	11	VW3E5001R200	12
LMC402CCG10000	11	VW3E5001R250	12
LMC402CCI10000	11	VW3E5001R300	12
LMC402CCL10000	11	VW3E5001R400	12
LMC600CAA1D0RC	13	VW3E5001R500	12
LMC600CAA150RC	13	VW3E6004	10 11
LMC600CAA170RC	13	VW3E6019	9
LMC600CAA180RC	13	VW3E6020	10 11
LMC600CAA190RC	13	VW3E70350AA00	10
LMC600CAA10000	10	VW3E70360AA00	9
LMC600CBB10000	10	VW3E704000000	9
LMC600CBC10000	10	VW3E704100000	9
LMC600CBD10000	10	VW3E7037000000	11
LMC600CBG10000	10		

The Next Generation



Schneider Electric Industries SAS

Head Office
35, rue Joseph Monier
F-92500 Rueil-Malmaison
France

The information provided in this documentation contains general descriptions and/or technical characteristics of the performance of the products contained herein. This documentation is not intended as a substitute for and is not to be used for determining suitability or reliability of these products for specific user applications. It is the duty of any such user or integrator to perform the appropriate and complete risk analysis, evaluation and testing of the products with respect to the relevant specific application or use thereof. Neither Schneider Electric nor any of its affiliates or subsidiaries shall be responsible or liable for misuse of the information contained herein.

Design: Schneider Electric
Photos: Schneider Electric

www.schneider-electric.com/msx