

WLB32



Industrial Light Bar

- Advanced LED lighting technology providing high-quality and maintenance-free industrial lighting solutions that will last for years.
- High brightness with an even light output for a no-glare glow
- Robust metal housing, shatterproof light cover and easy installation
- Ideal for work stations, machine lighting, control cabinets and manufacturing lines





WLB32
Industrial
Light Bar

Easy Installation. Superior Light. Long Lasting.

The WLB32 is a bright LED fixture that features an even light output to eliminate glare.



- Energy efficient for overall cost savings Metal housing, shatterproof window
- Easy installation with snap clips, or a choice of magnetic or swivel brackets



- Available in AC or DC models
- Available in 285 mm, 570 mm, 850 mm or 1130 mm lengths



- High/Low/Off switch allows users to customize light levels



- Motion detection models are ideal for locations that cannot use a physical switch or where the placement of the switch is not useful



- Models featuring an eye shield block line of sight to the domed window to increase eye comfort



Available as cascadable models for a continuous length of lighting, with minimal wiring



High-Quality LED Lighting for Workstations

Application Challenges:

Lighting only needs to be used when workers are present

Solution:

Operators need highly bright illumination in workstations to accurately and efficiently complete tasks. For workstations that need multiple lights, having an LED light with a switch that allows operators to adjust the lighting level as well as turn lights off when finished helps reduce overall energy costs. The motion detector models can automate this function.

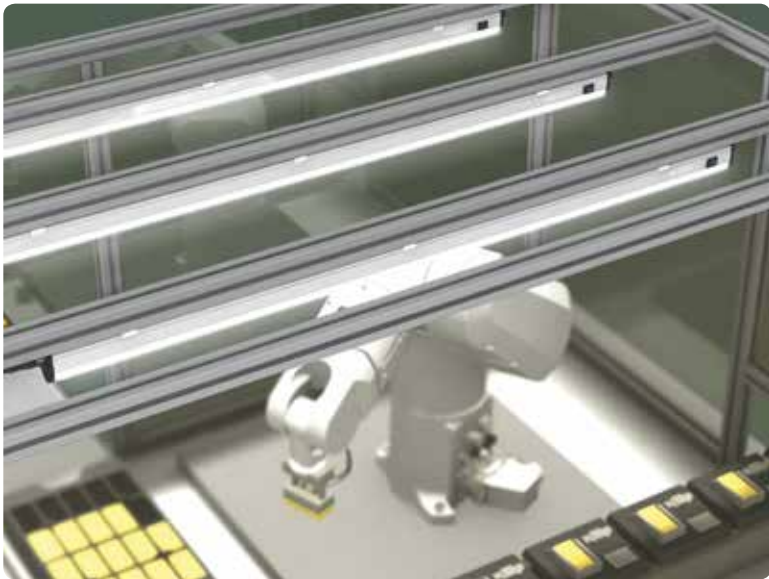

Robotic Cell Illumination

Challenges:

Large environment with high risk of impact

Solution:

Rugged and very bright LED illumination with the WLB32 Industrial Light Bar. Many factors come into play when choosing the correct light source for a robotic cell. Light source placement, brightness and application must all be considered before choosing the correct system to properly illuminate a robotic cell.

Advanced Illumination Data

- Photometric data (IES files)
- Candela charts
- Lumen and Lux data

Available on www.bannerengineering.com

Polar Candela Distribution

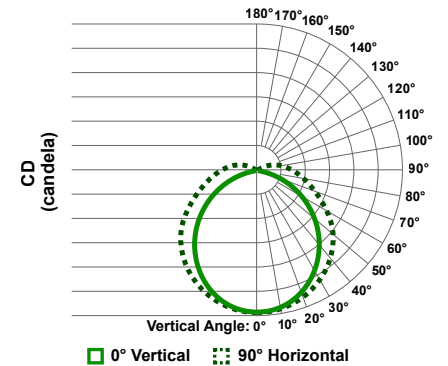

Illuminance at a Distance

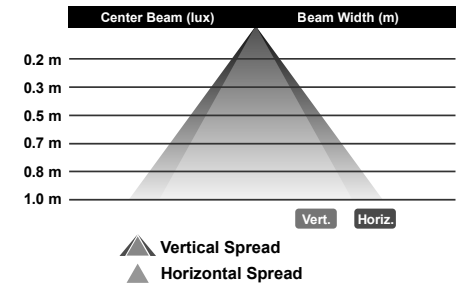



WLB32 Industrial Light Bar

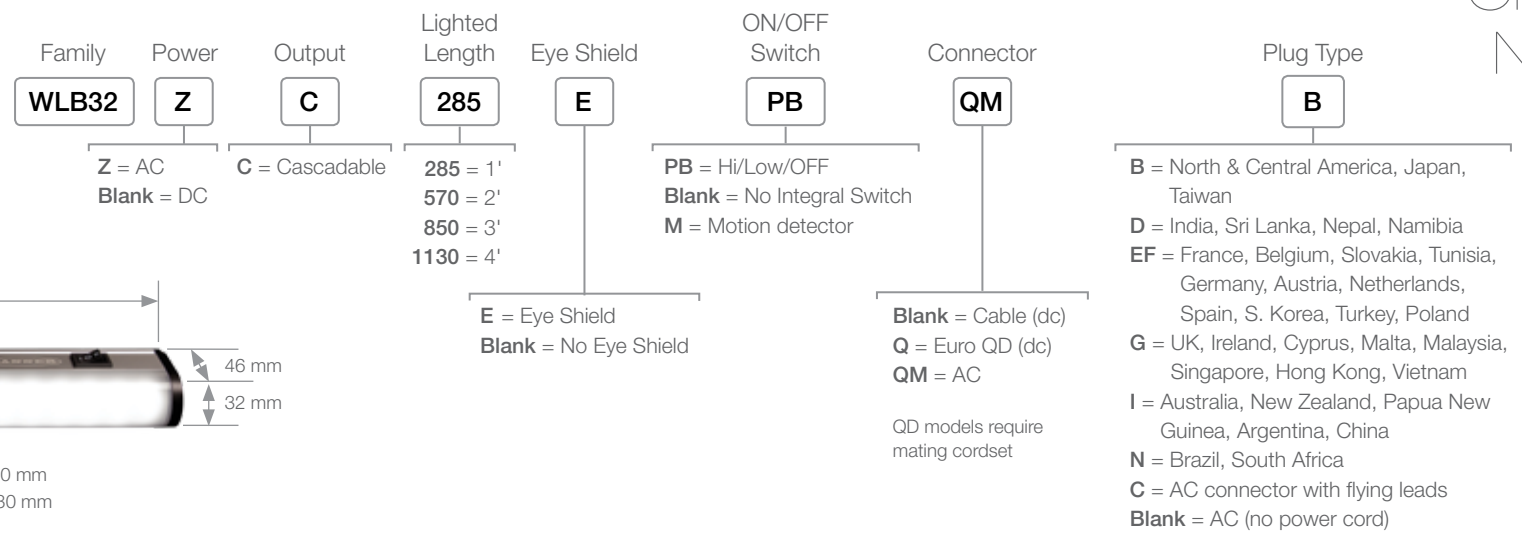

Lighted Length (L)

285 mm	850 mm
570 mm	1130 mm

Lighted Length (mm)	Lumens (Typical @ 25 °C) Daylight White	AC Models Typical Wattage* (Watts)	DC Models Typical Wattage* (Watts)
285	650	9	7.4
570	1300	18	14.8
850	1950	27	22.2
1130	2600	36	29.6

* Typical operating wattage is measured at 120 V ac or 24 V dc, depending on model

Operating Voltage	12 to 30 V dc (dc models) 90 to 264 V ac (ac models)	Switch	High = 100% intensity Low = 50% intensity
Lumen Output	≈ 650/ft	Environmental Rating	IP50 — Dry location only
LED Lifetime (L70)	50,000 hours	Certifications	
Color Temperature (CCT)	Daylight White — 5000 k		

Accessories

Brackets



AC Cascade Cordsets*

Type	Length	Model
Double-Ended Cascading Cordset Male straight/Male straight connectors	0.15 m (0.5')	LQMAEC-3005SS
	0.31 m (1.0')	LQMAEC-301SS
	0.91 m (3.0')	LQMAEC-303SS
	1.83 m (6.0')	LQMAEC-306SS
	3.66 m (12.0')	LQMAEC-312SS
	6.10 m (20.0')	LQMAEC-320SS
	9.14 m (30.0')	LQMAEC-330SS

* DC cascade and power cordsets, and additional accessories are available on www.bannerengineering.com

AC Power Cordsets*

Type	Model	Description
Power Cordset 1.8 m (6')	LQMAC-306	Flying Leads
	LQMAC-306B	North & Central America, Japan, Taiwan
	LQMAC-306D	India, Sri Lanka, Nepal, Namibia
	LQMAC-306EF	France, Belgium, Slovakia, Tunisia, Germany, Austria, Netherlands, Spain, S. Korea
	LQMAC-306G	UK, Ireland, Cyprus, Malta, Malaysia, Singapore, Hong Kong, Vietnam
	LQMAC-306I	Australia, New Zealand, Papua New Guinea, Argentina, China
	LQMAC-306N	Brazil

