



XLC-60-MAS Series  
(Independent type)



XLC-60-MA Series  
(Built-in type)

User's Manual



### ■ Features

- Constant power mode output with multiple stage selectable by DIP switch (H-type)
- Constant voltage mode output(12/24/48V)
- Plastic housing with class II and PFC design
- Flicker free, complying with CE ErP directive
- Standby power consumption <0.5W
- Meet emergency lighting (EL) application
- Minimum dimming level 0.1% (12/24/48V)
- Minimum dimming level 0.5% (H-type)
- Matter over thread, Matter 1.3 specification
- 5 years warranty

### ■ Applications

- Recessed Light
- Down Light
- Panel Light
- Commercial Lighting
- Decorative Lighting
- LED strip lighting
- Matter wireless Lighting

### ■ GTIN CODE

MW Search: <https://www.meanwell.com/serviceGTIN.aspx>

### ■ Description

XLC-60-MA series is a 60W with constant power and constant voltage output LED driver . It can operate from 100~305V AC and output current ranging between 900 mA to 1700 mA selectable by DIP switch. Thanks to high efficiency up to 90%, it is able to operate for -25℃ ~90℃ case temperature under free air convection. XLC-60-MA series is designed based on latest safety regulations with matter wireless dimming. It provides more flexibility for LED Lighting application.

### ■ Model Encoding

XLC - 60 -  - MA

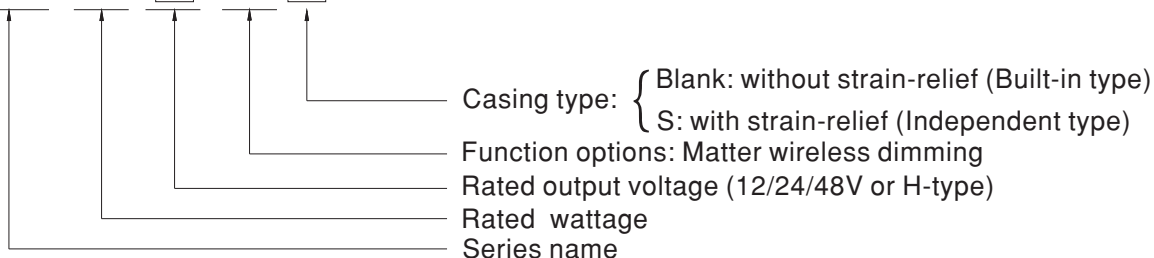

Type	Function	Note
MA	H type output current selectable by DIP switch, without strain-relief(Built-in type)	In stock
	12, 24, 48V Constant voltage output, without strain-relief(Built-in type)	
MAS	H type output current selectable by DIP switch, with strain-relief(Independent type)	In stock
	12, 24, 48V Constant voltage output, with strain-relief(Independent type)	

**SPECIFICATION**

MODEL		XLC-60 -12-MA □	XLC-60-24-MA □	XLC-60-48-MA □	
OUTPUT	DC VOLTAGE	12V	24V	48V	
	DEFAULT CURRENT	5A	2.5A	1.25A	
	RATED POWER <b>Note.2</b>	60W	60W	60W	
	SETUP,RISE TIME <b>Note.3</b>	2500ms,180ms/230VAC ,2500ms,180ms/115VAC			
INPUT	VOLTAGE RANGE	100~305VAC 155~400VDC			
	FREQUENCY RANGE	47 ~ 63Hz			
	POWER FACTOR	PF≥0.95/115VAC, PF≥0.95/230VAC, PF≥0.9/277VAC@full load (Please refer to "POWER FACTOR (PF) CHARACTERISTIC" section)			
	TOTAL HARMONIC DISTORTION	THD<20%(@load ≥60%/230VAC; @load ≥75%/277VAC); THD<10%@load 100%/230VAC (Please refer to "TOTAL HARMONIC DISTORTION(THD)" section)			
	EFFICIENCY(Typ.)	86%	87%	88%	
	AC CURRENT	0.75A/115VAC, 0.35A/230VAC, 0.3A/277VAC			
	INRUSH CURRENT	COLD START 15A(twidth=310μs measured at 50% Ipeak) at 230VAC; Per NEMA 410			
	MAX. NO. of PSUs on 16A CIRCUIT BREAKER	25 units (circuit breaker of type B) / 36 units (circuit breaker of type C) at 230VAC			
PROTECTION	OVERLOAD	105~200% rated output power Protection type: Hiccup mode, recovers automatically after fault condition is removed.			
	SHORT CIRCUIT	Hiccup mode, recovers automatically after fault condition is removed			
ENVIRONMENT	OVER VOLTAGE	14~17V	26~35V	52~63V	
	OVER TEMPERATURE	Shut down output voltage, recovers automatically after fault condition is removed			
	WORKING TEMP.	Tcase=-25~90℃ (Please refer to " OUTPUT LOAD vs TEMPERATURE" section)			
	MAX. CASE TEMP.	Tcase=90℃			
SAFETY & EMC	WORKING HUMIDITY	20 ~ 90% RH non-condensing			
	STORAGE TEMP.,HUMIDITY	-40 ~ +80℃, 10 ~ 95% RH			
	TEMP. COEFFICIENT	±0.03%/℃ (0 ~ 50℃)			
	VIBRATION	10 ~ 500Hz, 2G 10min./1cycle, period for 60min. each along X, Y, Z axes			
	SAFETY STANDARDS	CSA C22.2 No. 250.13-12; IEC BS EN/EN61347-1, BS EN/EN61347-2-13(EL) appendix J suitable for emergency installations (DC input 176-280VDC); BS EN/EN62384 , GB/T 19510.1, GB/T 19510.213, EAC TP TC 004 approved; Design refer to AS/NZS 61347-1, AS/NZS 61347-2-13			
OTHERS	WITHSTAND VOLTAGE	I/P-O/P: 3.75KVAC			
	ISOLATION RESISTANCE	I/P-O/P: >100M Ohms / 500VDC / 25℃ / 70% RH			
	EMC EMISSION	Parameter	Standard	Test Level/Note	
		Conducted	BS EN/EN55015(CISPR15) ,GB/T 17743	-----	
		Radiated	BS EN/EN55015(CISPR15) ,GB/T 17743	-----	
		Harmonic Current	BS EN/EN61000-3-2 , GB17625.1	Class C @load≥60%	
	EMC IMMUNITY	Voltage Flicker	BS EN/EN61000-3-3	-----	
		Parameter	Standard	Test Level/Note	
		ESD	BS EN/EN61000-4-2	Level 3, 8KV air ; Level 2, 4KV contact	
		Radiated	BS EN/EN61000-4-3	Level 2	
EFT/Burst		BS EN/EN61000-4-4	Level 2		
Surge		BS EN/EN61000-4-5	Level 3, 1KV/Line-Line		
Conducted		BS EN/EN61000-4-6	Level 2		
NOTE	Magnetic Field	BS EN/EN61000-4-8	Level 2		
	Voltage Dips and Interruptions	BS EN/EN61000-4-11	70% residual voltage for 10 period, 0% residual voltage for 0.5 periods		
	MATTER STANDARD	Matter 1.3 Specification			
	FLICKER <b>Note.7</b>	PstLM ≤ 1, SVM ≤ 0.4			
OTHERS	MTBF	4130.5K hrs min. Telcordia SR-332 (Bellcore)	317.7Khrs min.	MIL-HDBK-217F (25℃)	
	DIMENSION	176*45*32mm , 136*45*32mm (L*W*H)			
	PACKING	0.32Kg; 40pcs/13.8Kg/0.48CUFT(for Blank type); 0.39Kg; 40pcs/16.6Kg/0.61CUFT(for S-type);			

- All parameters NOT specially mentioned are measured at 230VAC input, rated current and 25℃ of ambient temperature.
- De-rating may be needed under low input voltages. Please refer to "STATIC CHARACTERISTIC" sections for details.
- Length of set up time is measured at first cold start. Turning ON/OFF the driver may lead to increase of the set up time.
- Standby power consumption is measured at 230VAC.
- The driver is considered as a component that will be operated in combination with final equipment. Since EMC performance will be affected by the complete installation, the final equipment manufacturers must re-qualify EMC Directive on the complete installation again.  
(as available on [https://www.meanwell.com/Upload/PDF/EMI\\_statement\\_en.pdf](https://www.meanwell.com/Upload/PDF/EMI_statement_en.pdf))
- The ambient temperature derating of 3.5℃/1000m with fanless models and of 5℃/1000m with fan models for operating altitude higher than 2000m(6500ft).
- Flicker is measured at full load with the light source provided by MEAN WELL.
- For XLC-S series: RCM is on a voluntary basis. Non IC classification Independent LED control gear is not suitable for residential installations.  
For XLC(except -S) series: RCM is on a voluntary basis and meets relevant IEC or AS/NZS standards complying with AS/NZS 4417.1.
- This series meets the typical life expectancy of 50000 hours of operation when Tcase, particularly(C)point(or TMP, per DLC), is about 75℃ or less.
- For more information, please contact with MEAN WELL sales.

※ Product Liability Disclaimer: For detailed information, please refer to <https://www.meanwell.com/serviceDisclaimer.aspx>

**SPECIFICATION**

<b>MODEL</b>		XLC-60-H-MA <input type="checkbox"/>			
<b>OUTPUT</b>	OPEN CIRCUIT VOLTAGE <small>Note.2</small>	60V			
	DEFAULT CURRENT	1400mA			
	CURRENT ADJ. RANGE (BY DIP SWITCH)	0.9~1.7A			
	CONSTANT CURRENT REGION	9~54V			
	RATED POWER <small>Note.4</small>	60W			
	CURRENT RIPPLE <small>Note.5</small>	<4%			
	CURRENT TOLERANCE	±5%			
	DIMMING RANGE	0~100%			
SETUP, RISE TIME <small>Note.6</small>	2500ms,100ms/230VAC ,2500ms,100ms/115VAC				
<b>INPUT</b>	VOLTAGE RANGE	100-305VAC 155-400VDC			
	FREQUENCY RANGE	47 ~ 63Hz			
	POWER FACTOR	PF ≥0.95/115VAC, PF ≥0.95/230VAC, PF ≥0.9/277VAC@full load (Please refer to "POWER FACTOR (PF) CHARACTERISTIC" section)			
	TOTAL HARMONIC DISTORTION	THD< 20%(@load ≥60%/230VAC; @load ≥75%/277VAC); THD<10%@load 100%/230VAC (Please refer to "TOTAL HARMONIC DISTORTION(THD)" section)			
	EFFICIENCY(Typ.) <small>Note.7</small>	90%			
	AC CURRENT	0.75A/115VAC, 0.35A/230VAC, 0.3A/277VAC			
	INRUSH CURRENT	COLD START 15A(twidth=310µs measured at 50% Ipeak) at 230VAC; Per NEMA 410			
	MAX. NO. of PSUs on 16A CIRCUIT BREAKER	25 units (circuit breaker of type B) / 36 units (circuit breaker of type C) at 230VAC			
	LEAKAGE CURRENT	<0.75mA / 277VAC			
	STANDBY POWER CONSUMPTION <small>Note.9</small>	Standby power consumption<0.5W (Dimming off)			
<b>PROTECTION</b>	SHORT CIRCUIT	Hiccup mode, recovers automatically after fault condition is removed			
	OVER TEMPERATURE	Stage 1: De-rating to 75% loading; Stage 2: De-rating to 50% loading. Recovers automatically after fault condition is removed.			
<b>ENVIRONMENT</b>	WORKING TEMP.	Tcase=-25~90°C (Please refer to "OUTPUT LOAD vs TEMPERATURE" section)			
	MAX. CASE TEMP.	Tcase=90°C			
	WORKING HUMIDITY	20 ~ 90% RH non-condensing			
	STORAGE TEMP., HUMIDITY	-40 ~ +80°C, 10 ~ 95% RH			
	TEMP. COEFFICIENT	±0.03%/°C (0 ~ 50°C)			
	VIBRATION	10 ~ 500Hz, 2G 10min./1cycle, period for 60min. each along X, Y, Z axes			
<b>SAFETY &amp; EMC</b>	SAFETY STANDARDS	CSA C22.2 No. 250.13-12; ENEC BS EN/EN61347-1, BS EN/EN61347-2-13(EL) appendix J suitable for emergency installations (DC input 176-280VDC); BS EN/EN62384 , GB/T 19510.1, GB/T 19510.213, EAC TP TC 004 approved; Design refer to AS/NZS 61347-1, AS/NZS 61347-2-13			
	WITHSTAND VOLTAGE	I/P-O/P: 3.75KVAC			
	ISOLATION RESISTANCE	I/P-O/P: >100M Ohms / 500VDC / 25°C / 70% RH			
	EMC EMISSION	Conducted	Parameter	Standard	Test Level/Note
		Radiated		BS EN/EN55015(CISPR15) ,GB/T 17743	-----
		Harmonic Current		BS EN/EN61000-3-2 , GB17625.1	Class C @load≥60%
		Voltage Flicker		BS EN/EN61000-3-3	-----
	EMC IMMUNITY		BS EN/EN61547		
			Parameter	Standard	Test Level/Note
		ESD		BS EN/EN61000-4-2	Level 3, 8KV air ; Level 2, 4KV contact
		Radiated		BS EN/EN61000-4-3	Level 2
		EFT/Burst		BS EN/EN61000-4-4	Level 2
		Surge		BS EN/EN61000-4-5	Level 3, 1KV/Line-Line
		Conducted		BS EN/EN61000-4-6	Level 2
Magnetic Field			BS EN/EN61000-4-8	Level 2	
		Voltage Dips and Interruptions	BS EN/EN61000-4-11	70% residual voltage for 10 period, 0% residual voltage for 0.5 periods	
<b>OTHERS</b>	MATTER STANDARD	Matter 1.3 Specification			
	FLICKER <small>Note.10</small>	PstLM ≤ 1, SVM ≤ 0.4			
	MTBF	4130.5K hrs min. Telcordia SR-332 (Bellcore) 317.7Khrs min. MIL-HDBK-217F (25°C)			
	DIMENSION	176*45*32mm , 136*45*32mm (L*W*H)			
	PACKING	0.32Kg; 40pcs/13.8Kg/0.48CUFT(for blank type); 0.39Kg; 40pcs/16.6Kg/0.61CUFT(for S-type);			
<b>NOTE</b>	<p>1. All parameters NOT specially mentioned are measured at 230VAC input, rated current and 25°C of ambient temperature.</p> <p>2. Output hiccups under no-load condition.</p> <p>3. Please refer to "DRIVER METHODS OF LED MODULE".</p> <p>4. De-rating may be needed under low input voltages. Please refer to "STATIC CHARACTERISTIC" sections for details.</p> <p>5. Current ripple is measured 50%~100% of maximum voltage under rated power delivery.</p> <p>6. Length of set up time is measured at first cold start. Turning ON/OFF the driver may lead to increase of the set up time.</p> <p>7. Efficiency is measured at 1050mA/54V output set by DIP switch.</p> <p>8. For XLC-S series: RCM is on a voluntary basis. Non IC classification Independent LED control gear is not suitable for residential installations. For XLC(except -S) series: RCM is on a voluntary basis and meets relevant IEC or AS/NZS standards complying with AS/NZS 4417.1.</p> <p>9. Standby power consumption is measured at 230VAC.</p> <p>10. Flicker is measured at full load with the light source provided by MEAN WELL.</p> <p>11. The driver is considered as a component that will be operated in combination with final equipment. Since EMC performance will be affected by the complete installation, the final equipment manufacturers must re-qualify EMC Directive on the complete installation again. (as available on <a href="https://www.meanwell.com/Upload/PDF/EML_statement_en.pdf">https://www.meanwell.com/Upload/PDF/EML_statement_en.pdf</a>)</p> <p>12. The ambient temperature derating of 3.5°C/1000m with fanless models and of 5°C/1000m with fan models for operating altitude higher than 2000m (6500ft).</p> <p>13. This series meets the typical life expectancy of 50000 hours of operation when Tcase, particularly@point (or TMP, per DLC), is about 75°C or less.</p> <p>14. For more information, please contact with MEAN WELL sales.</p> <p>⊗ Product Liability Disclaimer: For detailed information, please refer to <a href="https://www.meanwell.com/serviceDisclaimer.aspx">https://www.meanwell.com/serviceDisclaimer.aspx</a></p>				

**BLOCK DIAGRAM**

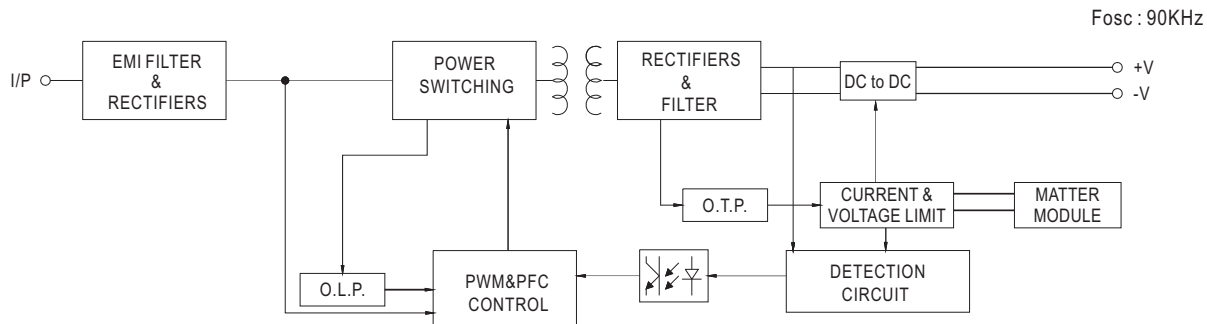

**DRIVING METHODS OF LED MODULE**

※ I-V Operating Area

◎ XLC-60-H-MA

For 60W application

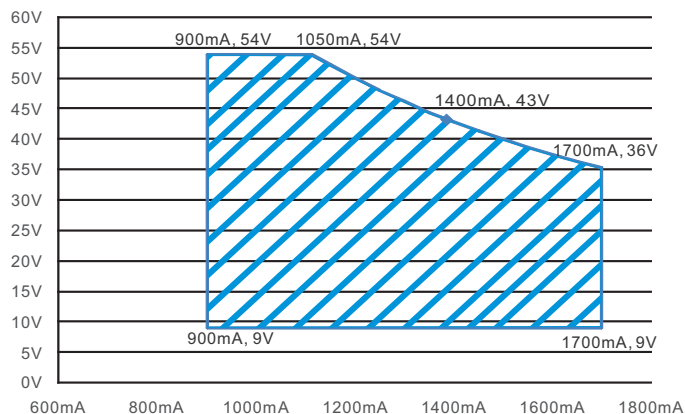

**CONSTANT POWER TABLE**

XLC-60-H-MA is a multiple-stage constant power driver, selection of output current through DIP switch setting is exhibited below.

Vo	Io	DIP S.W	1	2	3
9~54V	900mA		----	----	----
9~54V	1050mA		----	----	ON
9~50V	1200mA		----	ON	----
9~46V	1300mA		----	ON	ON
9~43V	1400mA(default)		ON	----	----
9~40V	1500mA		ON	----	ON
9~38V	1600mA		ON	ON	----
9~36V	1700mA		ON	ON	ON

Note: The operating voltage range which show on this table is recommend to use.

**■ PWM OUTPUT DIMMING PRINCIPLE**

- ※ For 12V/24V/48V PWM style output dimming
- Dimming is achieved by varying the duty cycle of the output current.

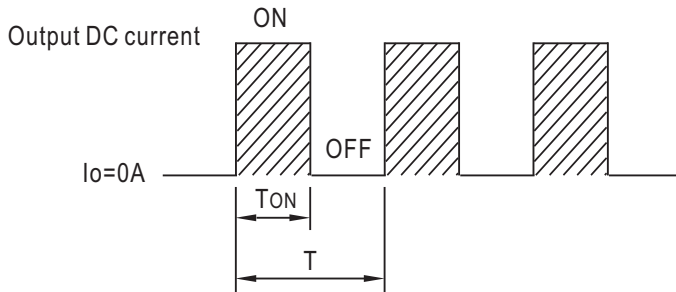

$$\text{Duty cycle(\%)} = \frac{T_{ON}}{T} \times 100\%$$

Output PWM frequency : 3.2kHz(Typ.)

**■ OUTPUT LOAD vs TEMPERATURE**

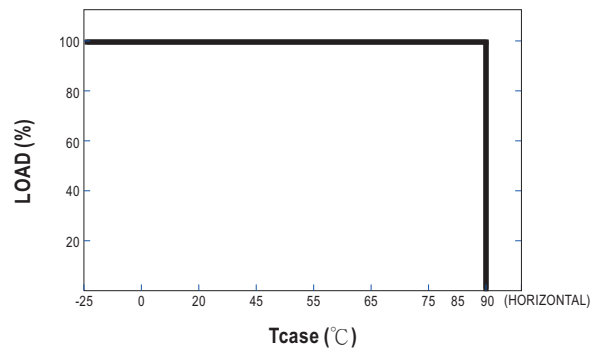
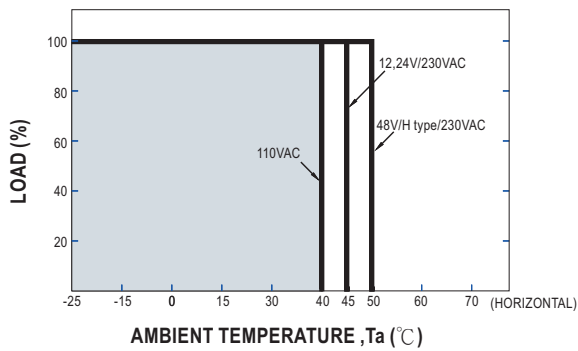

**■ STATIC CHARACTERISTIC**

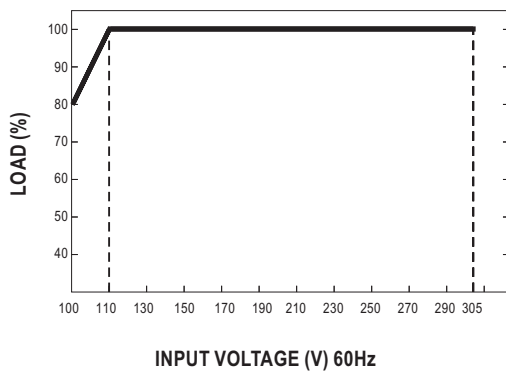

※ De-rating is needed under low input voltage.

**■ LIFE TIME**

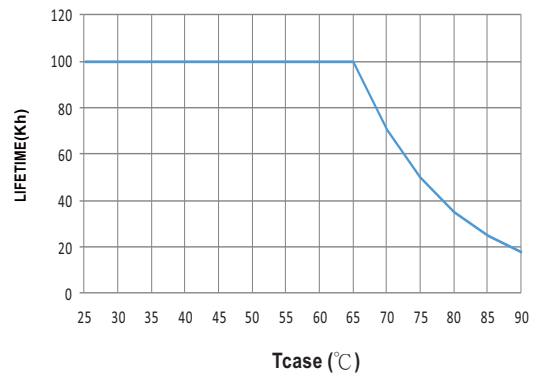

### TOTAL HARMONIC DISTORTION (THD)

※ XLC-60-H-MA Modle, Tcase at 75°C

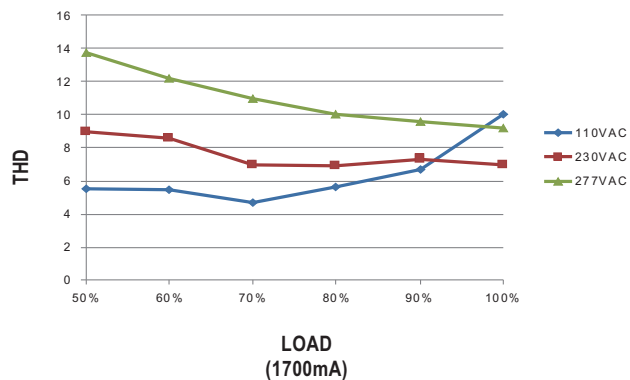
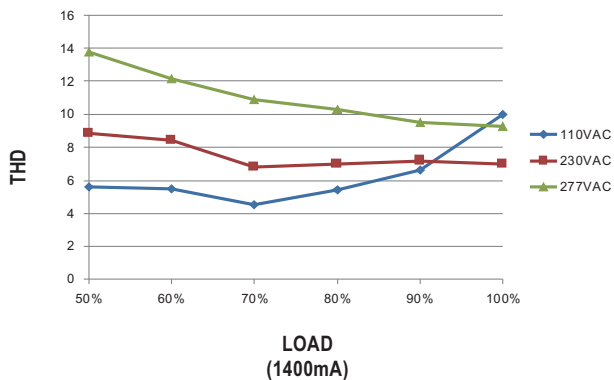

### POWER FACTOR (PF) CHARACTERISTIC

※ XLC-60-H-MA Modle, Tcase at 75°C

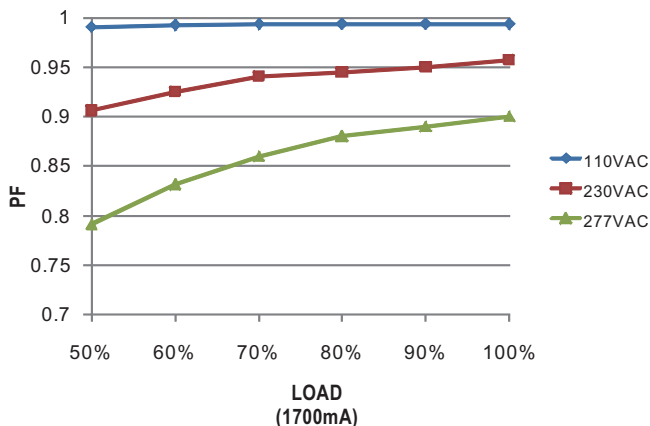
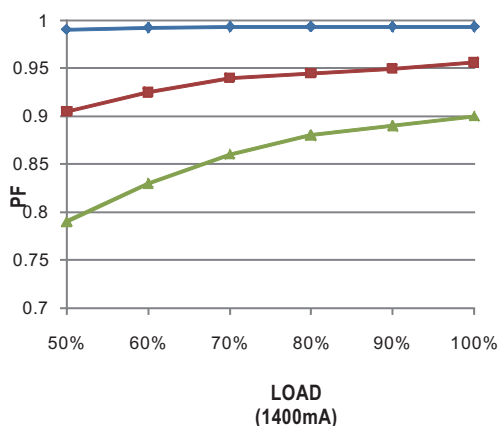

### EFFICIENCY vs LOAD

XLC-60-H-MA series possess superior working efficiency that up to 90% can be reached in field applications.

※ XLC-60-H-MA Modle, Tcase at 75°C

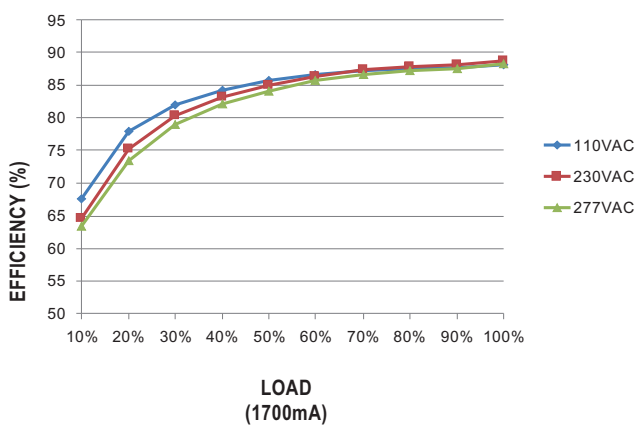
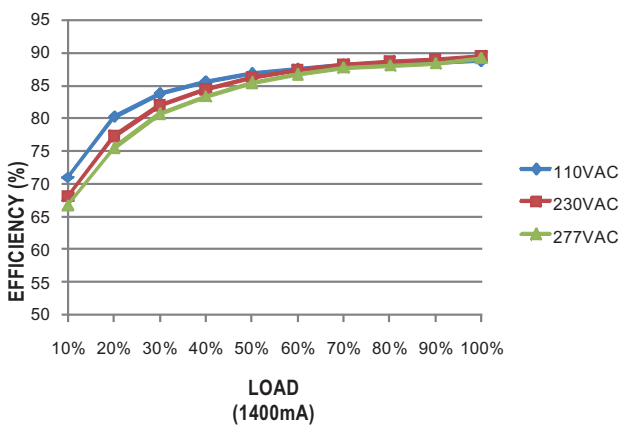

**MECHANICAL SPECIFICATION**

※ XLC-60-MA series Built-in Type

Case No.XLC-60  
Unit:mm Tolerance:±1

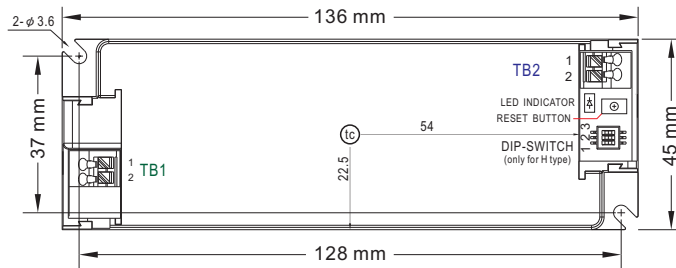

※ Terminal Pin No. Assignment(TB1)

Pin No.	Assignment
1	AC/N
2	AC/L

※ Terminal Pin No. Assignment(TB2)

Pin No.	Assignment
1	+V
2	-V

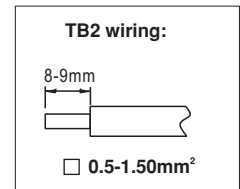
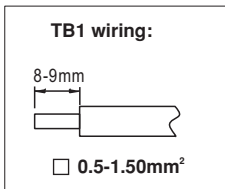

※ XLC-60-MAS series Independent Type

Case No.XLC-60-S  
Unit:mm Tolerance:±1

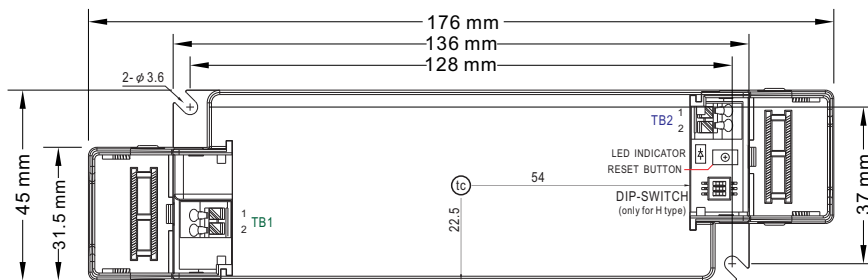

※ Terminal Pin No. Assignment(TB1)

Pin No.	Assignment
1	AC/N
2	AC/L

※ Terminal Pin No. Assignment(TB2)

Pin No.	Assignment
1	+V
2	-V

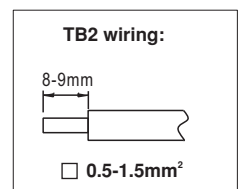
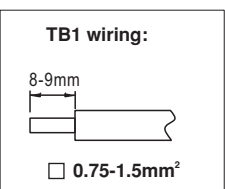

※ LED indicator

Flash slowly	Bluetooth Broadcast running
Flash quickly	Factory Reset running.
Constantly ON	Matter wireless connected
Constantly OFF	Matter wireless disconnected and Bluetooth Broadcast OFF

**FACTORY RESET**

※ By RESET BUTTON

Press and hold the reset button for 10 seconds. When the LED indicator flashes quickly, release the button. The factory reset will then be completed.

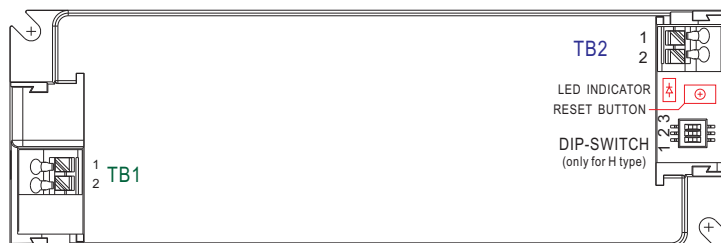

※ By AC ON/OFF

To perform factory reset through AC ON/OFF, the following process must be strictly followed. If the AC ON/OFF process is correct, the output light will flash for 15 seconds. When the flashing stop, it means the factory reset is completed. This operation is consistent with the factory reset effect performed by long-pressing the reset button.

AC ON/OFF process to executes factory reset:

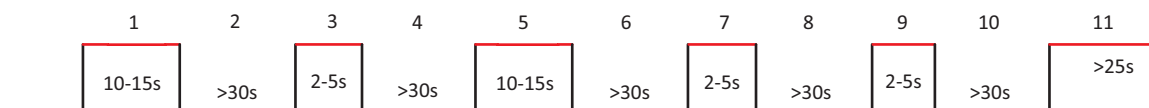

Phase	Duration	AC status
1	10-15s	ON
2	>30s	OFF
3	2-5s	ON
4	>30s	OFF
5	10-15s	ON
6	>30s	OFF
7	2-5s	ON
8	>30s	OFF
9	2-5s	ON
10	>30s	OFF
11	>25s	ON(should wait until output light stop flashing)

If there is a malfunction in the 'AC ON/OFF process', the process can be reset by the following method, starting from stage 1 again.

Method 1: AC ON time exceeds 25 seconds



Method 2: AC ON times for 2-5s and twice





**■ PLACEMENT**

Mean Well device has an integrated antenna for easy integration. In order to maximize the range in every direction, some design guidelines should be taken into consideration when mounting the device.

The antenna positions of the device are shown in the figure below:

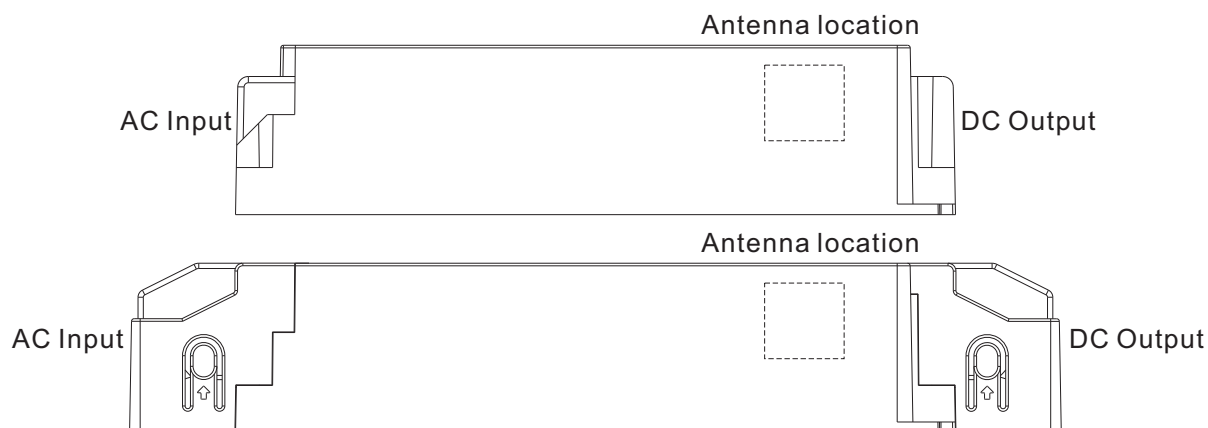

- Keep the device as far away as possible from vertical metal structures.
- When the device is mounted on a metal plate, the antenna should not be obscured, and there needs to be a cutout under the antenna to ensure that the RF signal can be transmitted.
- The device's communication range may be influenced by environmental factors and installation positioning, necessitating on-site adjustments and testing.

**■ Installation Manual**

Please refer to : <http://www.meanwell.com/manual.html>