

NOS



Eye bolts & swivels
Øjebolte & svirvler





Index

Eye nut - DIN 582 C15E.....	4.4
Eye bolt - DIN 580 C15E.....	4.4
Stainless steel eye nut - DIN 582.....	4.5
Stainless steel eye bolt - DIN 580.....	4.5
Eye bolt.....	4.6
Swivel eye bolt with ring.....	4.7
Yoke - Swivel lifting point.....	4.8
Yoke LBO Extended bolt.....	4.9
Yoke - Sunpoint.....	4.9
Yoke - Swivel lifting point.....	4.10
Yoke - Weld-on lifting point.....	4.11
Swivel AISI 316.....	4.12
HD Swivel AISI 304.....	4.12
Flexible swivel AISI 304.....	4.12
Ball bearing swivel.....	4.13
Ring clutch - DEHA type.....	4.13
Ring clutch - FRIMEDA type.....	4.13

Indhold

Øjemøtrik - DIN 582 C15E.....	4.4
Øjebolt - DIN 580 C15E.....	4.4
Rustfri øjemøtrik - DIN 582.....	4.5
Rustfri øjebolt - DIN 580.....	4.5
Øjebolt.....	4.6
Svirvel øjebolt med ring.....	4.7
Yoke - Svirvel øjebolt.....	4.8
Yoke LBO lang bolt.....	4.9
Yoke - Sunpoint.....	4.9
Yoke - Svirvel øjebolt.....	4.10
Yoke - Til påsvejsning løftepunkt.....	4.11
Svirvel AISI 316.....	4.12
HD Svirvel AISI 304.....	4.12
Fleksibel svirvel AISI 304.....	4.12
Kugleleje svirvel.....	4.13
Løftebeslag - DEHA type.....	4.13
Løftebeslag - FRIMEDA type.....	4.13



Eye nut - DIN 582 C15E

- Approved for lifting
- Galvanized
- Safety factor 4:1

Øjemøtrik - DIN 582 C15E

- Godkendt til løft
- Galvaniseret
- Sikkerhedsfaktor 4:1

Art. No.	WLL ton*	Dimensions - mm						Weight kg
		D	A	B	C	F	H	
04 09 0001	0,07	M6	16	28	17	6	31	0,048
04 09 0002	0,14	M8	20	36	20	8	36	0,05
04 09 0003	0,23	M10	25	45	25	10	45	0,09
04 09 0004	0,34	M12	30	54	30	12	53	0,16
04 09 0005	0,7	M16	35	63	34	14	62	0,24
04 09 0006	1,2	M20	40	72	40	16	71	0,36
04 09 0007	1,8	M24	50	90	50	20	90	0,72
04 09 0008	3,6	M30	60	108	65	24	109	1,32
04 09 0009	5,1	M36	70	126	75	28	128	2,08
04 09 0010	8,6	M48	91	160	95	38	180	6,4

Other sizes available on request

Andre størrelser på forespørgsel

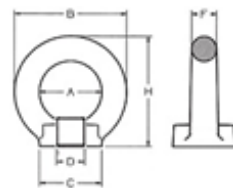

Eye bolt - DIN 580 C15E

- Approved for lifting
- Galvanized
- Safety factor 4:1

Øjebolt - DIN 580 C15E

- Godkendt til løft
- Galvaniseret
- Sikkerhedsfaktor 4:1

Art. No.	WLL ton	Dimensions - mm						Weight kg
		D x L	A	B	C	F	H	
04 10 0001	0,07	M6x13	16	28	17	6	31	0,05
04 10 0002	0,14	M8x13	20	36	20	8	36	0,06
04 10 0003	0,23	M10x17	25	45	25	10	45	0,11
04 10 0004	0,34	M12x20,5	30	54	30	12	53	0,18
04 10 0005	0,7	M16x27	35	63	35	14	62	0,28
04 10 0006	1,2	M20x30	40	72	40	16	71	0,45
04 10 0007	1,8	M24x36	50	90	50	20	90	0,87
04 10 0008	3,6	M30x45	60	108	65	24	109	1,66
04 10 0009	5,1	M36x54	70	126	75	28	128	2,65
04 10 0010	8,6	M48x62	91	160	95	38	180	6,4

Other sizes available on request

Andre størrelser på forespørgsel

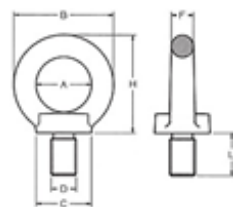



Stainless steel eye nut - DIN 582

- Not approved for lifting

Rustfri øjemøtrik - DIN 582

- Ikke godkendt til løft

Art. No.	Dimensions - mm						Weight kg
	D	A	B	C	F	H	
08 07 0001	M6	16	28	17	6	31	0,048
08 07 0002	M8	20	36	20	8	36	0,05
08 07 0003	M10	25	45	25	10	45	0,09
08 07 0004	M12	30	54	30	12	53	0,16
08 07 0005	M16	35	63	34	14	62	0,24
08 07 0006	M20	40	72	40	16	71	0,36
08 07 0007	M24	50	90	50	20	90	0,72



4

Stainless steel eye bolt - DIN 580

- Not approved for lifting

Rustfri øjebolt - DIN 580

- Ikke godkendt til løft

Art. No.	Dimensions - mm						Weight kg
	D x L	A	B	C	F	H	
08 06 0001	M6x13	16	28	17	6	31	0,05
08 06 0002	M8x13	20	36	20	8	36	0,06
08 06 0003	M10x17	25	45	25	10	45	0,11
08 06 0004	M12x20,5	30	54	30	12	53	0,18
08 06 0005	M16x27	35	63	35	14	62	0,28
08 06 0006	M20x30	40	72	40	16	71	0,45
08 06 0007	M24x36	50	90	50	20	90	0,87





Eye bolt

- Approved for lifting
- Painted

Øjebolt

- Godkendt til løft
- Malet

Art. No.	WLL ton	dimensions - mm							Weight kg
		D x L	A	B	C	E	F	H	
04 11 0001	0,4	M6x13	25	45	25	10	10	45	0,09
04 11 0002	0,8	M8x13	25	45	25	10	10	45	0,09
04 11 0003	1,0	M10x17	25	45	25	10	10	45	0,11
04 11 0004	1,6	M12x21	35	63	35	14	14	62	0,27
04 11 0005	3	M14x21	35	63	35	14	14	62	0,29
04 11 0006	4	M16x27	35	63	35	14	14	62	0,31
04 11 0007	5	M18x27	50	90	50	20	20	90	0,84
04 11 0008	6	M20x30	50	90	50	20	20	90	0,86
04 11 0010	8	M24x36	50	90	50	20	20	90	0,9
04 11 0011	10	M27x45	60	108	65	24	24	109	1,66
04 11 0012	12	M30x45	60	108	65	24	24	109	1,7
04 11 0014	16	M36x54	70	126	75	26	28	128	2,15
04 11 0015	24	M42x63	80	144	85	30	32	147	4,15
04 11 0016	32	M48x68	90	166	100	35	38	168	6,2

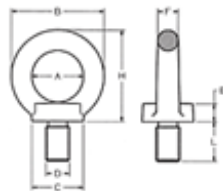

*Safety factor 4:1

*Sikkerhedsfaktor 4:1



Swivel eye bolt with ring

- WLL at 90° lifting
- Painted

Svirvel øjebolt med ring

- WLL ved 90° løft
- Malet

Art. No.	WLL ton	Dimensions - mm								Weight kg
		D x L	A	B	C	E	H	SW	D1	
04 12 0000	0,3	M8x13	30	13	46	43	96	30	36	0,42
04 12 0001	0,5	M10x18	30	13	46	45	96	30	36	0,43
04 12 0002	0,5	M12x18	30	13	46	45	96	30	36	0,43
04 12 0003	1,12	M14x20	30	13	46	45	96	30	36	0,44
04 12 0004	1,12	M16x20	30	13	46	45	96	30	36	0,45
04 12 0007	2,0	M20x30	35	16	58	56	125	40	50	0,97
04 12 0008	3,15	M24x30	40	18	70	65,5	150	46	57	1,48
04 12 0010	5,3	M30x35	40	20	69	80,5	165,5	-	66	2,17
04 12 0011	8	M30x35	50	22	95	92	207	-	80	3,57
04 12 0014	10	M36x50	50	22	95,5	89,5	204,5	-	80	3,60
04 12 0016	10	M42x50	50	22	95,5	89,5	204,5	-	80	3,73

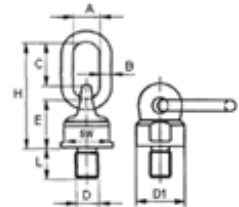

WLL in ton:

WLL i ton:

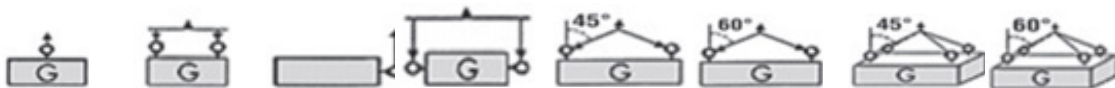

Size	1 leg		2 legs		2 legs		3-4 legs	
	0°	0°	90°	90°	0-45°	45-60°	0-45°	45-60°
M8x13	0,6	1,2	0,3	0,6	0,42	0,3	0,63	0,45
M10x18	0,9	1,8	0,45	0,9	0,63	0,45	0,945	0,675
M12x18	1	2	0,5	1	0,75	0,5	1,1	0,75
M14x20	2	4	1,12	2	1,5	1,12	2,36	1,6
M16x20	2	4	1,12	2	1,5	1,12	2,36	1,6
M20x30	4	8	2	4	2,8	2	4	3
M24x30	6,3	12,5	3,15	6,3	4,25	3,15	6,3	4,75
M30x35	10,6	21,2	5,3	10,6	7,1	5,3	11,2	8
M30x35	11,8	23,6	8	16	8,26	5,9	12,39	8,85
M36x50	11,8	23,6	8	16	8,26	5,9	12,39	8,85
M42x50	15	30	10	20	14	10	21,2	15

*Safety factor 4:1

*Sikkerhedsfaktor 4:1



Yoke - Swivel lifting point

- Type LBO
- Painted

Yoke - Svirvel øjebolt

- Type LBO
- Malet

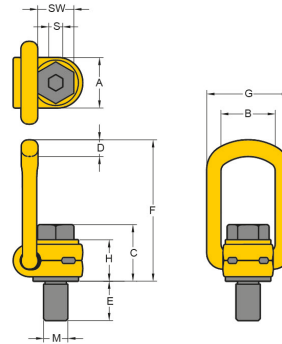

Art. No.	WLL ton	Dimensions											Weight kg	Torgue Nm
		M	E	A	B	C	D	F	G	H	S	SW		
04 45 1001	0,30	M8	11	30	35	35	10	85	55	29	6	13	0,2	30
04 45 1002	0,63	M10	16	30	35	36	10	85	55	29	6	17	0,3	60
04 45 1003	1,00	M12	18	33	37	44	14	98	57	36	8	19	0,5	100
04 45 1004	1,20	M14	21	33	37	45	14	98	57	36	10	22	0,5	120
04 45 1005	1,50	M16	24	33	37	46	14	98	57	36	10	24	0,5	150
04 45 1006	2,00	M18	26	50	54	57	17	140	82	44	12	30	1,3	200
04 45 1007	2,50	M20	30	50	54	57	17	140	82	44	12	30	1,3	250
04 45 1008	4,00	M24	36	50	54	59	17	140	82	44	14	36	1,4	400
04 45 1009	4,00	M27	38	60	65	79	23	170	99	62	17	41	2,8	400
04 45 1010	5,00	M30	48	60	65	81	23	170	99	62	17	46	3,1	500
04 45 1011	7,00	M36	54	60	65	88	23	178	99	65	22	55	3,3	700
04 45 1012	8,00	M36	62	77	85	101	27	225	124	78	22	55	5,8	800
04 45 1013	10,00	M42	72	77	85	104	27	225	124	78	24	65	6,3	1.000
04 45 1014	15,00	M42	63	95	104	112	36	256	158	86	24	65	10,8	1.500
04 45 1015	20,00	M48	72	95	104	120	36	259	158	90	27	75	11,6	2.000

*Safety factor 4:1

*Sikkerhedsfaktor 4:1



Yoke LBO Extended bolt

Yoke LBO lang bolt

Art. No.	Size	WLL ton	E Standard mm	E Max. length mm
04 45 1001 + L	M8	0,30	11	76
04 45 1002 + L	M10	0,63	16	96
04 45 1003 + L	M12	1,00	18	114
04 45 1005 + L	M16	1,50	24	149
04 45 1007 + L	M20	2,50	30	186
04 45 1008 + L	M24	4,00	36	221
04 45 1010 + L	M30	5,00	48	278
04 45 1011 + L	M36	8,00	62	22
04 45 1013 + L	M42	10,00	72	272
04 45 1014 + L	M42	15,00	57	264
04 45 1015 + L	M48	20,00	72	295

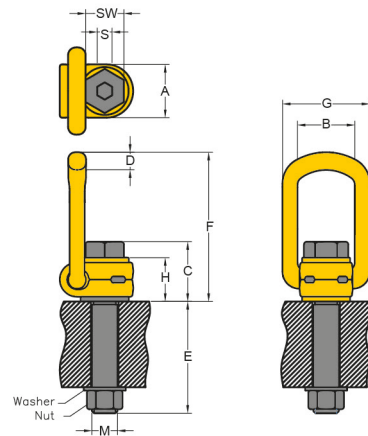

Please inform length upon ordering

Oplys venligst længde ved bestilling

Yoke - Sunpoint

- Type SPK
- Painted

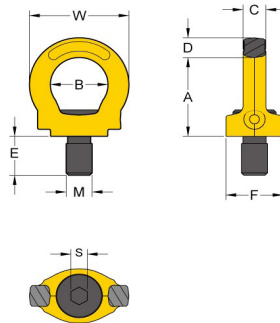

Yoke - Sunpoint

- Type SPK
- Malet

Art. No.	WLL ton	Size	Dimensions - mm								Weight kg
			A	B	C	D	E	F	S	W	
04 45 2001	0,30	M8	36	25	8	11	12	25	6	44	0,1
04 45 2002	0,40	M10	36	25	8	11	15	25	6	44	0,1
04 45 2003	0,75	M12	42	30	10	13	18	33	8	52	0,2
04 45 2004	1,50	M16	51	35	14	13	24	35	10	61	0,3
04 45 2005	2,30	M20	57	40	16	17	30	44	12	70	0,6
04 45 2006	3,20	M24	70	48	19	21	36	52	14	84	1,0
04 45 2007	4,50	M30	86	60	24	26	45	62	17	108	1,8
04 45 2008	7,00	M36	103	72	29	32	54	78	22	130	3,2
04 45 2009	9,00	M42	120	82	34	38	63	88	24	150	5,0
04 45 2010	12,00	M48	137	94	38	43	72	104	27	168	7,6

*Safety factor 4:1

*Sikkerhedsfaktor 4:1



Yoke - Swivel lifting point

- Type SPO
- With ball bearing
- Up to M100 available
- Safety factor 4:1

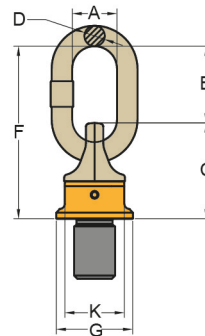
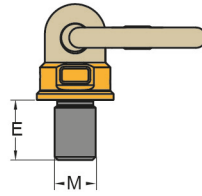

Yoke - Svirvel øjebolt

- Type SPO
- Med kuglelejer
- Muligt op til M100
- Sikkerhedsfaktor 4:1

Art. No.	WLL ton		Dimensions - mm									Weight kg	Torgue Nm
	90°	0°	M	E	A	B	C	D	F	G	K		
04 12 2001	0,5	1	M10	18	35	53	48	13	101	36,5	34	0,4	10-40
04 12 2002	0,7	1,4	M12	18	35	53	48	13	101	36,5	34	0,4	15-40
04 12 2002-25	0,7	1,4	M12	25	35	53	48	13	101	36,5	34	0,4	15-40
04 12 2003	1	2	M14	20	35	53	48	13	101	36,5	34	0,4	30-40
04 12 2004	1,4	2,8	M16	20	35	53	48	13	101	36,5	34	0,44	45-130
04 12 2004 - 24	1,4	2,8	M16	24	35	53	48	13	101	36,5	34	0,5	45-130
04 12 2004 - 30	1,4	2,8	M16	30	35	53	48	13	101	36,5	34	0,5	45-130
04 12 2005	1,7	3,4	M20	30	35	53	48	13	101	36,5	34	0,5	75-130
04 12 2005-30	2,5	5	M20	30	35	59	68	16	127	52	46	1,0	100-170
04 12 2005-40	2,5	5	M20	40	35	59	68	16	127	52	46	1,0	100-170
04 12 2005-50	2,5	5	M20	50	35	59	68	16	127	52	46	1,1	100-170
04 12 2005-70	2,5	5	M20	70	35	59	68	16	127	52	46	1,1	100-170
04 12 2006	1,7	3,4	M24	30	35	53	84	13	101	36,5	34	0,5	90-130
04 12 2006-30	4	8	M24	30	40	73	75	19	148	57	50	1,5	190-280
04 12 2006-36	4	8	M24	36	40	73	75	19	148	57	50	1,5	190-280
04 12 2006-45	4	8	M24	45	40	73	75	19	148	57	50	1,5	190-280
04 12 2006-50	4	8	M24	50	40	73	75	19	148	57	50	1,5	190-280
04 12 2007	4	8	M30	35	40	73	75	19	148	57	50	1,5	190-280
04 12 2007-35	6,7	12	M30	35	40	68	95	19	163	70	65	2,4	230-400
04 12 2007-45	6,7	12	M30	45	40	68	95	19	163	70	65	2,4	230-400
04 12 2007-50	6,7	12	M30	50	40	68	95	19	163	70	65	2,5	230-400
04 12 2007-60	6,7	12	M30	60	40	68	95	19	163	70	65	2,5	230-400
04 12 2007-135	8	12	M30	35	50	95	106	22	201	81	75	3,6	270-600
04 12 2007-145	8	12	M30	45	50	95	106	22	201	81	75	3,7	270-600
04 12 2008	10	15	M36	50	50	95	106	22	201	81	75	3,8	270-600
04 12 2008-54	10	15	M36	54	50	95	106	22	201	81	75	3,9	270-600
04 12 2009	12,5	15	M42	50	50	95	106	22	201	81	75	3,9	270-700
04 12 2009-60	12,5	15	M42	60	50	95	106	22	201	81	75	4,0	270-700
04 12 2009-63	12,5	15	M42	63	50	95	106	22	201	81	75	4,0	270-700
04 12 2009-160	13	20	M42	60	70	129	127	32	256	104	95	7,4	350-800
04 12 2010	12,5	15	M45	60	50	95	106	22	201	81	75	4,1	270-700
04 12 2010-60	17	25	M45	60	70	129	127	32	256	104	95	7,5	350-800
04 12 2011	12,5	15	M48	72	50	95	106	22	201	81	75	4,4	270-700
04 12 2011-60	17	25	M48	60	70	129	127	32	256	104	95	7,6	350-800

Yoke - Weld-on lifting point

- Type RGB

Yoke - Til påsvejsning løftepunkt

- Type RGB

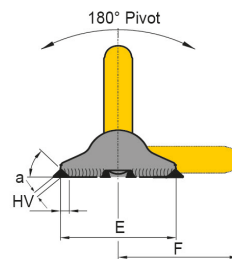
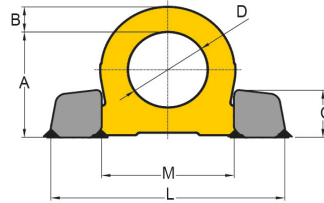

Art. No.	WLL ton	Dimensions - mm										Weight stk.
		A	B	C	D	E	F	L	M	a°	b	
02 14 0201	4,00	66	14	30	48,0	65	70	135	76	45	5	0,7
02 14 0202	6,70	85	20	39	60,0	89	91	171	98	45	5	1,5
02 14 0203	10,00	95	21	46	65,0	100	100	196	106	45	7	2,4
02 14 0204	16,00	127	30	57	90,0	130	136	263	149	45	8	5,5
02 14 0205	31,50	178	42	78	130,0	160	195	375	213	45	15	15,8

*Safety factor 4:1

*Sikkerhedsfaktor 4:1



Swivel AISI 316

- Stainless steel

Svirvel AISI 316

- Rustfrit stål

Art. No.	Size Ø mm	**BL/kg	Dimensions - mm					Weight kg
			A	B	C	D	E	
08 10 0001	6	0,27	14	14	14	14	64	0,05
08 10 0002	8	0,50	19	19	19	19	93	0,14
08 10 0003	10	1,10	30	28	20	20	110	0,23
08 10 0004	13	1,60	29	28	27	30	140	0,36
08 10 0005	16	3,20	43	38	35	47	180	0,89
08 10 0006	19	4,70	45	39	38	40	205	1,80

Can be delivered with WLL & test certificate, upon request

Kan leveres med WLL & testcertifikat på foresprgsel

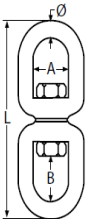

HD Swivel AISI 304

- Stainless steel

HD Svirvel AISI 304

- Rustfrit stål

Art. No.	Size Ø mm	MBL ton	Dimensions - mm					Weight kg
			A	B	C	D	E	
08 10 0007	22	31,5	45	40	40	42	222	2,25
08 10 0008	25	41,5	52	50	42	52	278	4,10
08 10 0009	32	60,0	60	50	50	98	350	8,15
08 10 0010	38	90,00	72	58	58	112	390	13,0

Can be delivered with WLL & test certificate, upon request

Kan leveres med WLL & testcertifikat på foresprgsel

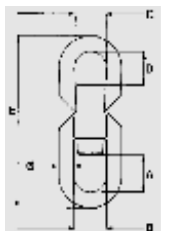

Flexible swivel AISI 304

- Stainless steel

Fleksibel svirvel AISI 304

- Rustfrit stål

Art. No.	Size Ø mm	MBL ton	Dimensions - mm					Weight kg
			A	B	C	D	E	
08 11 0001	13	8,0	30	28	28	34	160	0,56
08 11 0002	16	16,0	41	38	37	48	200	1,20
08 11 0003	19	23,5	44	40	40	54	235	2,00
08 11 0004	22	31,5	44	40	40	55	255	2,90
08 11 0005	25	41,5	55	50	45	70	320	4,70
08 11 0006	32	60,0	55	55	54	93	360	9,20
08 11 0007	38	90,0	62	58	60	110	410	14,6
08 11 0008	45	140,0	75	70	70	115	515	24,0

Can be delivered with WLL & test certificate, upon request

Kan leveres med WLL & testcertifikat på foresprgsel

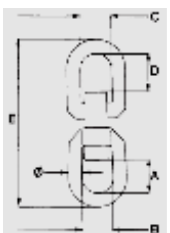



Ball bearing swivel

- Safety factor 5:1
- Eye in both ends

Kugleleje svirvel

- Sikkerhedsfaktor 5:1
- Øje i begge ender

Art. No.	Model	WLL ton	Dimensions - mm							Weight kg
			A	B	C	D	E	F	G	
04 16 0001	N401C	1	126	43	16	15	36	18	35	0,60
04 16 0002	N402C	2	157	54	20	20	45	22	45	1,50
04 16 0003	N404C	3	189	65	27	26	55	28	55	2,75
04 16 0004	N405C	5	220	70	33	30	64	33	60	3,90
04 16 0005	N408C	8	250	85	42	34	73	39	75	6,70
04 16 0006	N412C	12	295	95	50	41	86	45	86	10,60
04 16 0007	N417C	17	360	120	57	52	113	55	108	18,50
04 16 0008	N422C	22	435	131	60	52	118	63	118	29,70
04 16 0009	N432C	32	500	160	65	59	132	73	140	45,00
04 16 0010	N445C	45	700	220	102	74	190	100	200	130,00

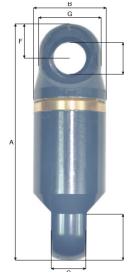

4

Ring clutch - DEHA type

Løftebeslag - DEHA type

Art. No.	Model	WLL ton	Dimensions - mm								
			A	B	C	ØD	E	F	G	H	J
02 22 0001	RC-1,3	1,3	44	74	70	56	54	32	162	20	12
02 22 0002	RC-2,5	2,5	56	88	85	68	66	42	196	25	14
02 22 0003	RC-5	5	68	118	88	88	83	57	237	37	16
02 22 0004	RC-10	7,5 - 10	82	160	112	112	113	73	339	50	26
02 22 0005	RC-20	15 - 20	113	191	135	152	151	110	447	75	30
02 22 0006	RC-32	32	175	269	189	195	214	153	584	100	45

SF4:1

SF4:1

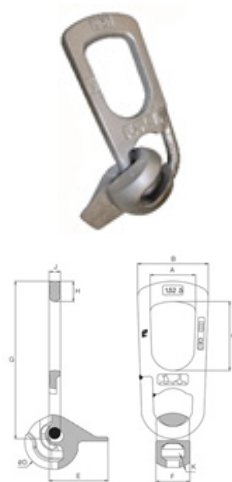

Ring clutch - FRIMEDA type

Løftebeslag - FRIMEDA type

Art. No.	Model	WLL ton	Dimensions - mm					
			A	B	C	D	E	F
02 23 0001	RCU-2,5	2,5	261	27	80	70	50	48
02 23 0002	RCU-5	5	330	36	100	86	71	-
02 23 0003	RCU-10	10	425	50	140	112	90	-
02 23 0004	RCU-26	26	605	72	209	160	120	-

*Safety factor 4:1

*Sikkerhedsfaktor 4:1

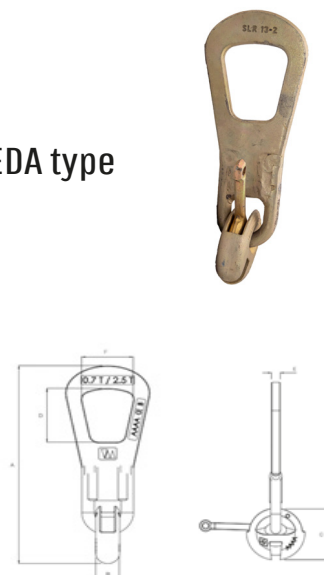



Eye bolts & swivels
Øjebolte & svirvler

We are supplier to OIL & GAS

NOS A/S has a strong network worldwide. This is important, because it means that if you need a product in e.g. Singapore tomorrow, we have the network to procure it locally and deliver it very quickly.

We know our sub-contractors well and are able to deliver products in exactly the right quality. We have our customers in focus, so that is why we do our best to find out what exactly you need. This ensures that we deliver the product/service you actually require.

We are especially known for delivering:

- Steel wire ropes
- Fiber ropes
- Lifting equipment
- Lashing equipment
- Fall protection equipment

Vi er leverandør til OLIE & GAS

Hos NOS A/S har vi et stærkt netværk Worldwide. Det er vigtigt, for det betyder, at hvis du skal bruge et produkt i Singapore i morgen, så har vi netværket til at skaffe det lokalt og levere meget hurtigt.

Vi kender vores underleverandører og kan levere produkterne i den kvalitet, du ønsker. Vi har kunden i fokus, så derfor gør vi vores bedste for at få afdækket, hvad det præcist er, du har behov for. Så er du sikker på, at du får leveret det, du rent faktisk skal bruge.

Vi er særligt kendt for at levere:

- Stålwirer
- Tovværk
- Løftegrej
- Surringsgrej
- Faldsikring

