

D^{med}® **halux** LED
EXAMINATION LIGHT

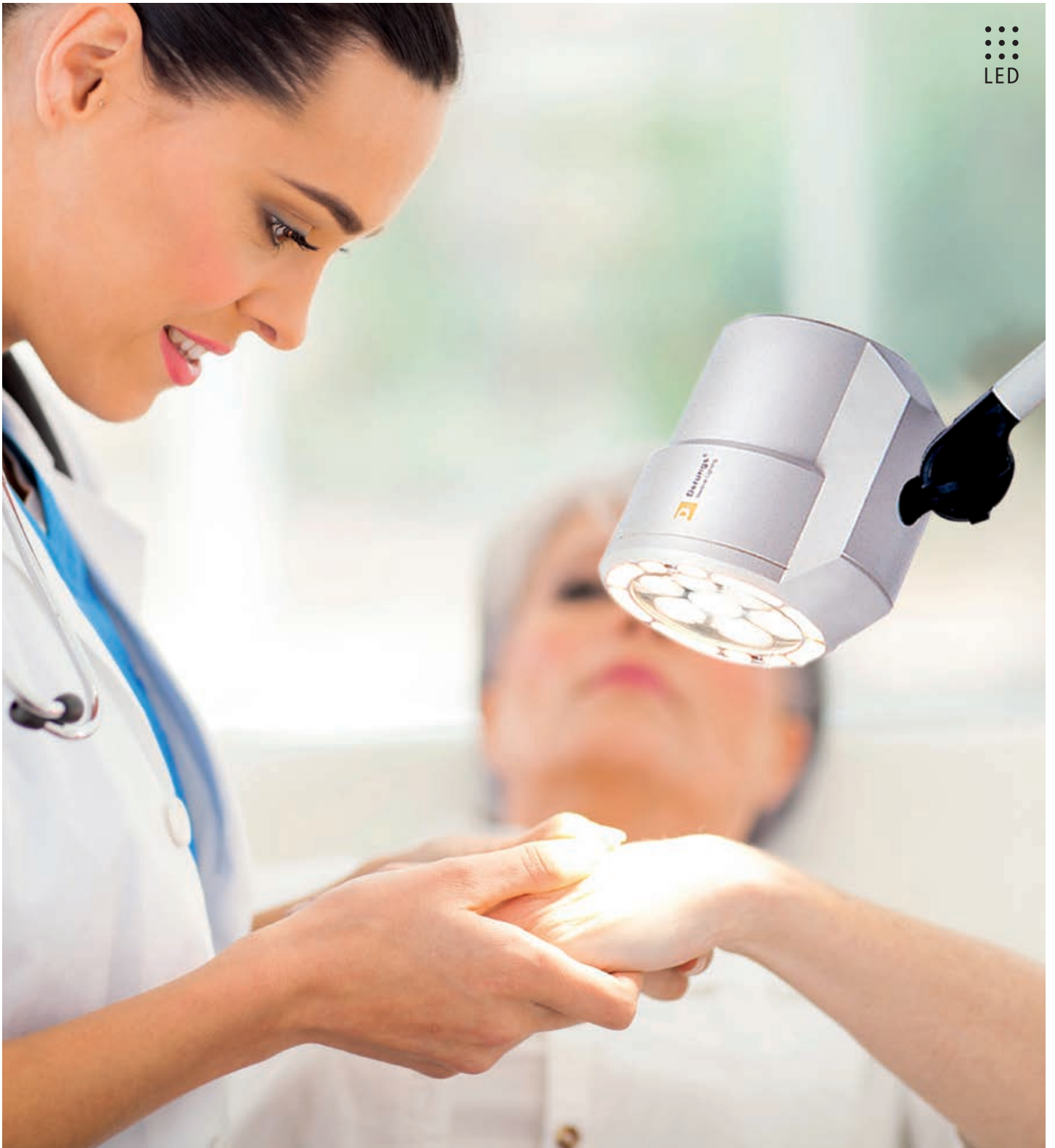

D^{med}® halux LED EXAMINATION LIGHT

Often, in examination rooms only a general lighting is used. An additional examination light (mounted on the mobile stand or directly at the examination table) ultimately achieves the required brightness (illuminance) and assists with the diagnosis.

SMALL - COMPACT - CLASSIC

Examination light in top quality

The a well-lit illumination field is generated by 7 powerful LEDs (about 40,000 lux at 0.5 meter). The light is considerably more pleasant to the eye and an absolutely true-color light is available in a diameter 170 mm.

Very good color rendering

By an excellent color rendering index of Ra > 93 characters of the skin (surface and deep structure) are easily visible. This means better detail recognition of the finest nuances of color in tissue for the physician. The illuminated area appears natural and contrasted.

Light color and dimming in 3 steps (only halux 20-3)

By color mixing of different LEDs an excellent innovation in the field of investigation is achieved. Depending on the examination the light color (color temperature in Kelvin) can be changed. The user thus has the possibility -depending on the skin, tissue or wound- to select the optimal inspection light. The light control is a simple, clear control unit directly at the lamp head. Here also the illuminance could be selected individually by 5 dimming levels.

The three color levels

3300 K	(warm white) Ideal for various types of skin tests
3800 K	(neutral white) Ideal for general examinations
4400 K	(cool white) Ideal for recognition of individual veins or for wound treatment and minor procedures



Spring-balanced arm system
For stepless positioning



LED:
40.000 lux / 0.5 m
One hand positioning

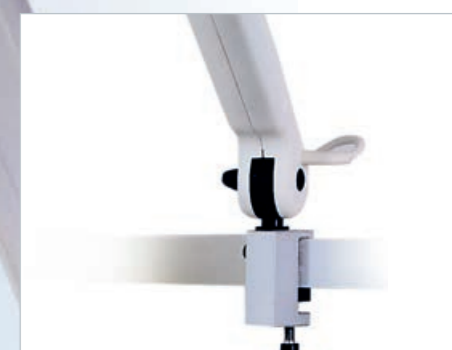

16 mm spigot:
For adaptation to rail systems, mobile stand, wall bracket

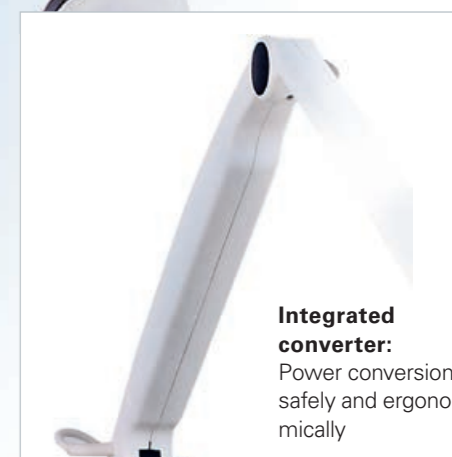

Integrated converter:
Power conversion safely and ergonomically



The benefits of the halux LED are obvious: more comfort and ergonomics due to individually selectable light trap device and highly flexible adjustability.

Applications shown:

- Neonatology
- General examinations



TECHNICAL DATA

Dmed® halux LED

Technical Drawing 20-3 P FX / 20-1 P FX

Light Distribution

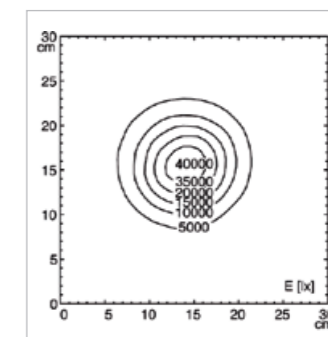
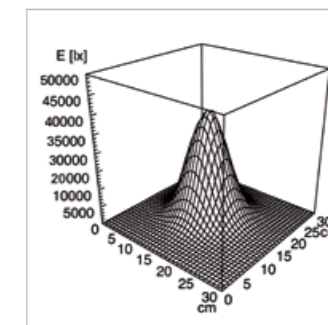
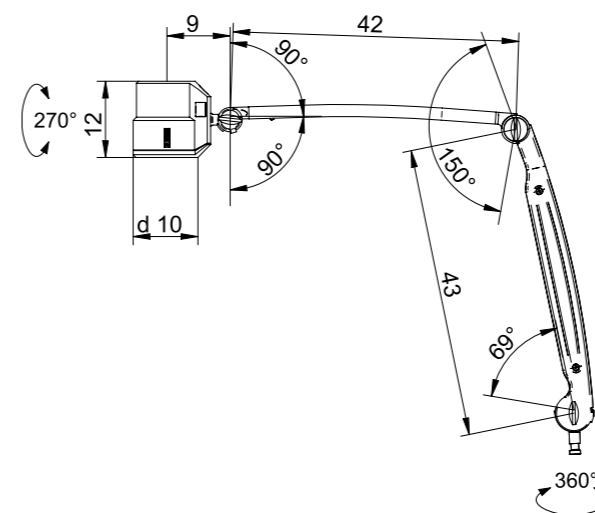

Illumination data -10% / +20% tolerance

Technical Drawing 20-3 P SX / 20-1 P SX

Light Distribution

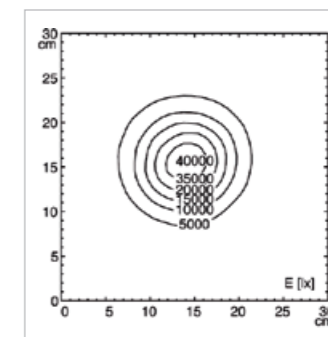
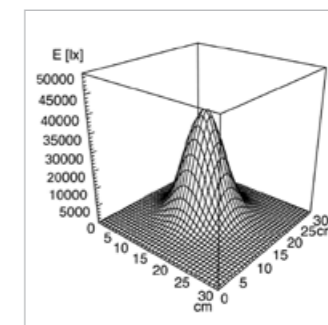
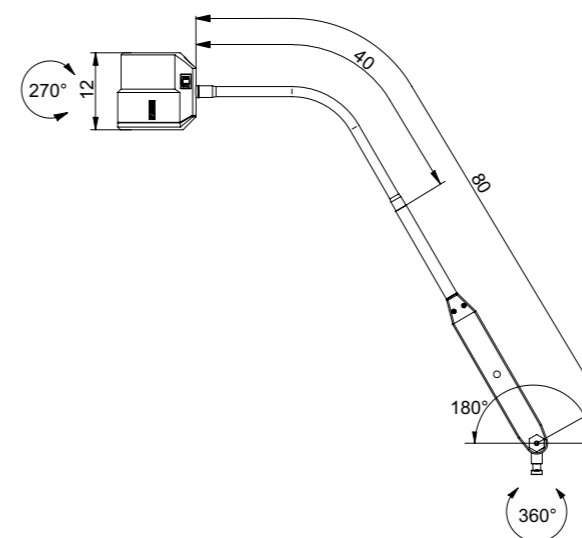

Illumination data -10% / +20% tolerance



The halux LED light is a loyal partner ideal for medical examinations. Unobtrusive, classic shape and proven in the application.

Applications shown:

- Gynaecology
- Dermatology
- Intensive Care



ORDER NUMBER

D^{med}® halux LED 20-3 with colour change, dimming (3300 K, 3800 K, 4400 K)

D ^{med} ® halux LED 20-3 P FX	D15.471.000	Euro
--	-------------	------

D ^{med} ® halux LED 20-3 P SX	D15.473.000	Euro
--	-------------	------

Note: Control panel on luminaire head.

D^{med}® halux LED 20-1 without colour change, without dimming (4400 K)

D ^{med} ® halux LED 20-1 P FX	D15.472.000	Euro
--	-------------	------

D ^{med} ® halux LED 20-1 P SX	D15.474.000	Euro
--	-------------	------

Note: ON/OFF switch on luminaire arm.

ACCESSOIRES

EXTENSION ARM



MATERIAL	Powder coated tubular steel
DIMENSIONS	400 mm, Ø 16 mm
WEIGHT (NET)	ca. 0,65 kg
FOR PIN Ø	16 mm-Q with removal guard
LOAD CAPACITY	2,5 kg
ORDER NUMBER	D13.363.000 - pure white

ROLLER STAND R TELESCOP



MATERIAL	Stainless steel
DIMENSIONS	0,8 - 1,4 m
WEIGHT (NET)	6,25 kg
FOR PIN Ø	16 mm-Q mit removal guard
ORDER NUMBER	D14.911.000

RAIL MOUNT



MATERIAL	Aluminium
EQUIPMENT RAIL	25-35 x 8-10 mm
ORDER NUMBER	D13.269.000

WALL MOUNT



MATERIAL	Polyamide GF
ORDER NUMBER	D13.231.000 - pure white

OWN DISTRIBUTORS

GERMANY

Herbert Waldmann GmbH & Co. KG
Postfach 5062
78057 Villingen-Schwenningen
Germany
Telephone +49 7720 601 100
Fax +49 7720 601 290
www.waldmann.com
sales.germany@waldmann.com

SWEDEN

Waldmann Ljusteknik AB
Skebokvarnsvägen 370
124 50 Bandhagen
Sweden
Telephone +46 8 990 350
Fax +46 8 991 609
www.waldmann.com
info-se@waldmann.com

SWITZERLAND

Waldmann Lichttechnik GmbH
Benkenstrasse 57
5024 Küttigen
Switzerland
Telephone +41 62 839 12 12
Fax +41 62 839 12 99
www.waldmann.com
info-ch@waldmann.com

USA

Waldmann Lighting Company
9, W. Century Drive
Wheeling, Illinois 60090
USA
Telephone +1 847 520 1060
Fax +1 847 520 1730
www.waldmannlighting.com
waldmann@waldmannlighting.com

AUSTRIA

Waldmann Lichttechnik Ges.m.b.H
Gewerbepark Wagram 7
4061 Pasching/Linz
Austria
Telephone +43 7229 67 400
Fax +43 7229 67 444
www.waldmann.com
info-at@waldmann.com

SINGAPORE

Waldmann Lighting Singapore Pte. Ltd.
22 Cross Street
02-50/51
South Bridge Court
Singapore 048421
Singapore
Telephone +65 6275 8300
Fax +65 6275 8377
www.waldmann.com
sales-sg@waldmann.com

FRANCE

Waldmann Eclairage S.A.S
Z.I. - Rue de l'Embranchement
67116 Reichstett
France
Telephone +33 3 8820 95 88
Fax +33 3 8820 95 68
www.waldmann.com
info-fr@waldmann.com

CHINA

Waldmann Lighting (Shanghai) Co. Ltd.
Part A, No. Five Normative Workshop
199 Changjian Road, Baoshan
Shanghai, P.R.C. 200949
China
Telephone +86 21 5169 1799
Fax +86 21 3385 0032
www.waldmann.com
info@waldmann.com.cn

ITALY

Waldmann Illuminotecnica S.r.l.
Via della Pace, 18 A
20098 San Giuliano Milanese (MI)
Italy
Telephone +39 02 98 24 90 24
Fax +39 02 98 24 63 78
www.waldmann.com
info-it@waldmann.com

INDIA

Waldmann Lighting PVT. Ltd.
Plot No. 52
Udyog Vihar
Phase-VI, Sector-37
GURGAON-122001, Haryana
India
Telephone +91 124 412 1600
Fax +91 124 412 1611
www.waldmann.com
sales-in@waldmann.com

NETHERLANDS

Waldmann BV
Lingewei 19
4004 LK Tiel
Netherlands
Telephone +31 344 631 019
Fax +31 344 627 856
www.waldmann.com
info-nl@waldmann.com

Derungs Licht AG

Hofmattstrasse 12
9200 Gossau
Switzerland
Telephone +41 71 388 11 66
Fax +41 71 388 11 77
www.derungslicht.com
mailbox@derungslicht.com



Further distribution partners you find at: www.derungslicht.com