

Precision
in Motion



TechnoVector 7 –
Machine vision
wheel alignment systems



TechnoVector wheel adaptors
support rim sizes from 12" up to 24"

Techno Vector Group

TechnoVector wheel aligner has four or two Widescope high-resolution cameras in two separate posts or a single beam. Cameras are installed in front of the car. Targets are attached to the car's wheels using wheel adaptors.



Digital high-resolution cameras with an embedded IR backlight allow the TechnoVector software to track precise spatial positions of each target



Easy-to-use and lightweight and compact wheel adaptors and targets

The ultimate innovation in wheel alignment

Unique WideScope technology

- Perform measurement at a wide range of lift heights* without repositioning cameras.
- A more compact installation without any loss of accuracy
- Significantly decreases the time it takes to perform an alignment

* - depends on the installation distance

(See pages 6-7 for more details)

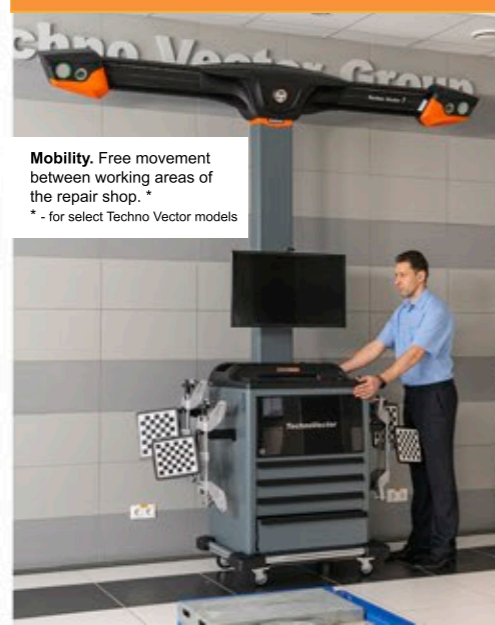

Mobility. Free movement between working areas of the repair shop. *
* - for select Techno Vector models



TechnoVector wheel alignment systems use cameras to observe targets determining wheel's precise position in 3D space

Perform compensation for all 4 wheels simultaneously by rolling the vehicle

Machine Vision System



High-definition cameras capture targets and transfer image data to the TechnoVector software

The software calculates highly precise positions of targets in 3D-space

Cameras

The use of machine vision technologies allows high-precision readings

Firmware promotes a real time display

Targets

Retroreflecting targets without any electronic components with a protective layer coating

Optima series

- Easy to use
- Light and compact targets
- Rubber frame to protect from accidents



PRO series Premium series

- Easy to use
- Super-light magnesium alloy targets
- Plastic frame to protect from accidents
- Support magnetic and 3-point wheel adaptors



Four-camera wheel aligner's kit



Two-camera wheel aligner's kit



Wheel Adaptors

Self-centering wheel adaptors with the adjustable central mechanism support 12" to 24" wheel rims and are compatible with light duty and middle duty vehicles

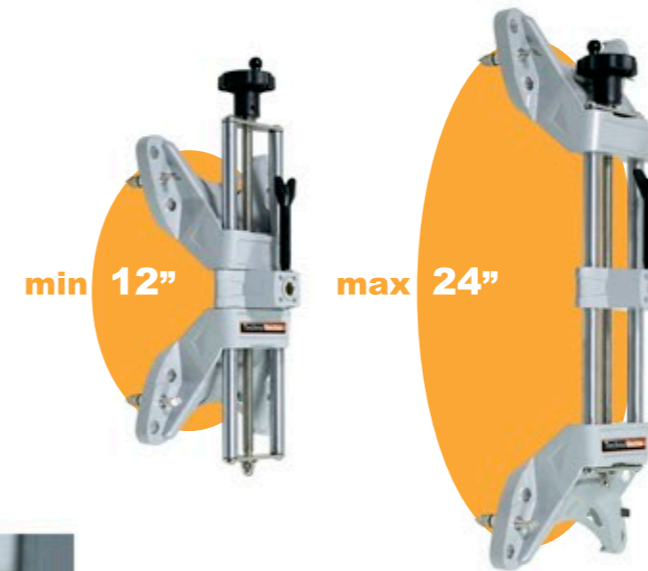

Adaptors



Double sided studs make it easy to attach wheel adaptors to both steel and light-alloy rims

Optional equipment



Set of magnetic wheel adaptors



Set of 3-point wheel adaptors





Two-camera
wheel alignment systems

Additional display with helpful hints. Useful when the technician has no line of sight to the computer's screen.

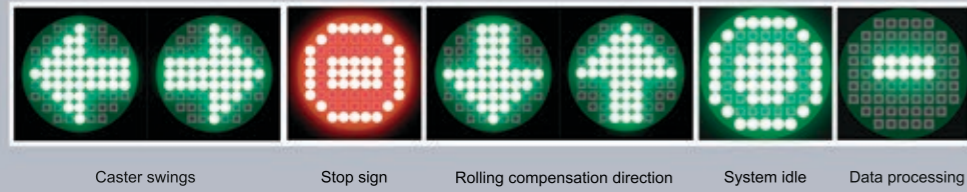

Four-camera
wheel alignment systems

Additional display with helpful hints. Useful when the technician has no line of sight to the computer's screen.

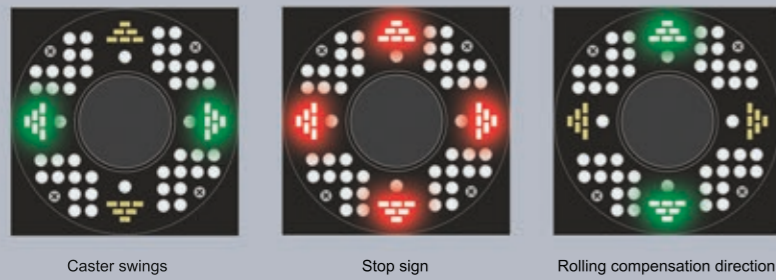

Wide-angle machine vision system

Key advantages of the WideScope technology

- Measure and adjust at any lift height *
- Accommodate to the workplace. Install closer or further away, depending on the space available
- Continue adjustment even if the target's is partially occluded

*depends on the installation distance (see page 7)

WideScope®

Lift position tracking

This feature can be useful if the lift can't stay level at different heights.

The software automatically detects lift movement and compensates the difference.

Camera field of view diagrams with WideScope technology

Four-camera
wheel alignment systems

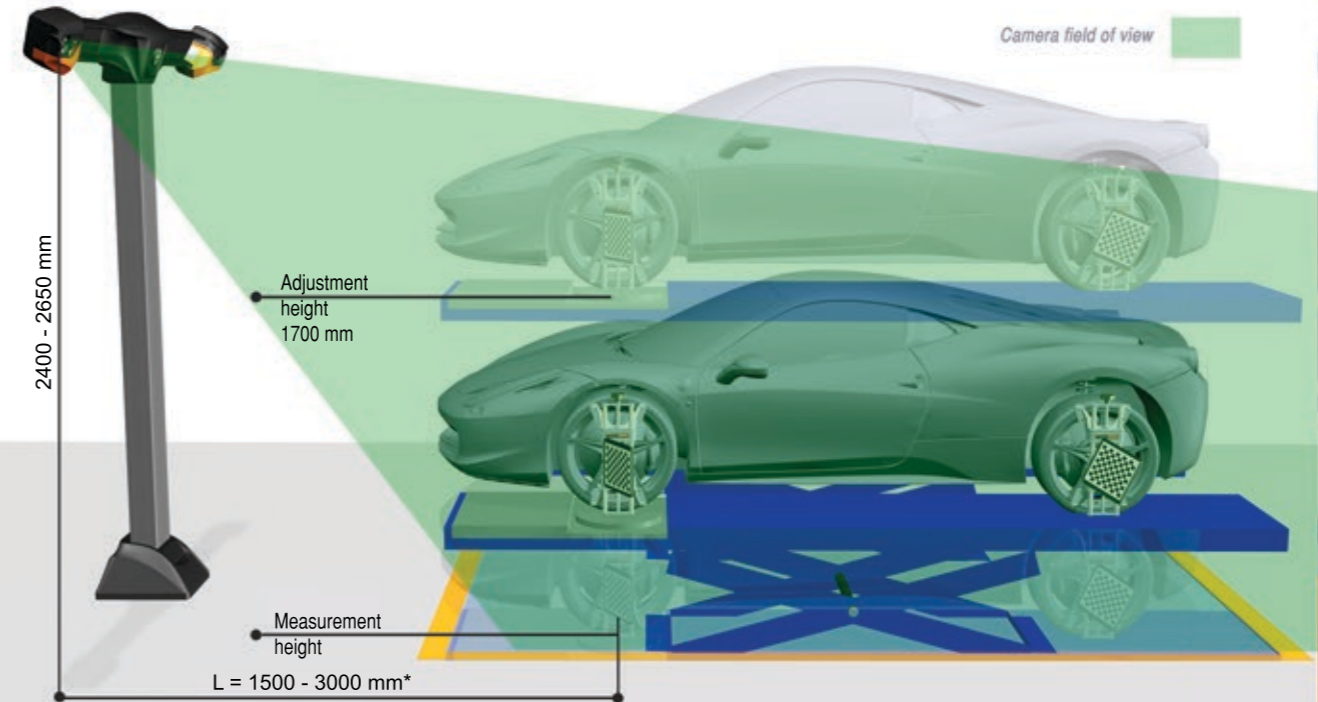

* Visibility of targets at the lift floor level may be reached at the distance starting from 2200 mm

Two-camera
wheel alignment systems

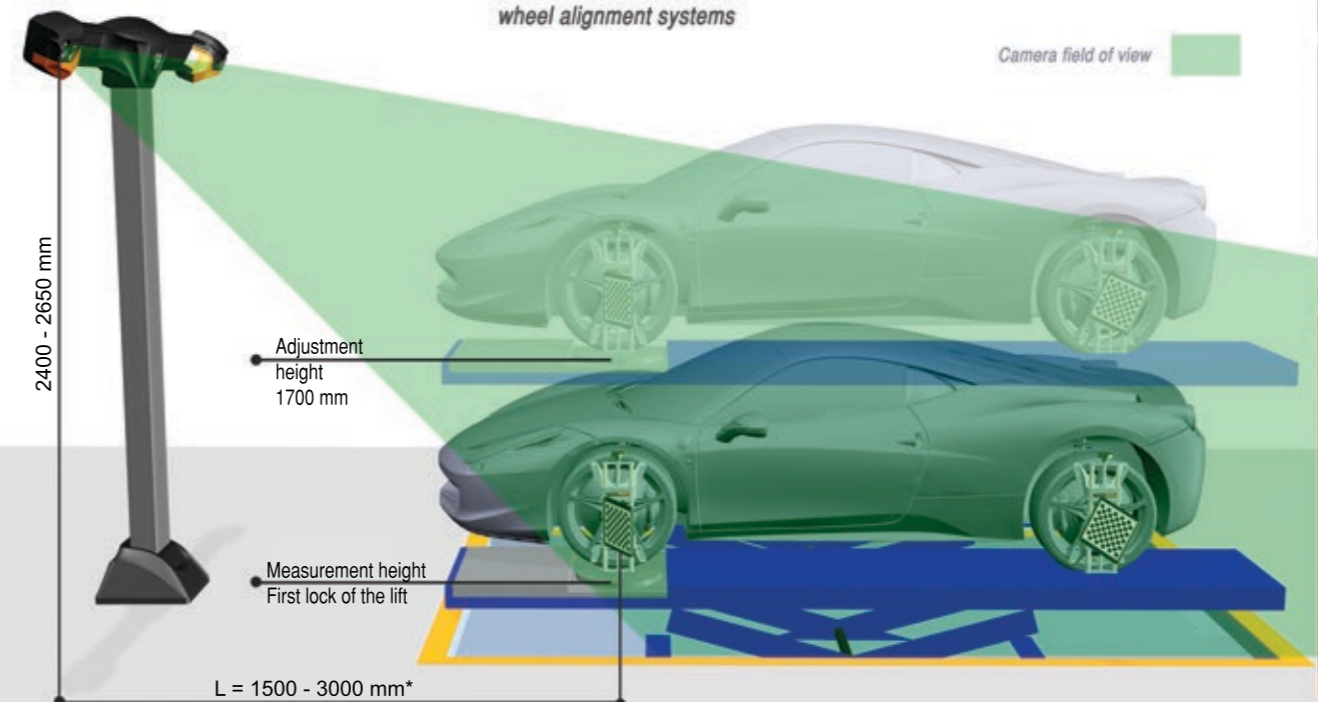

* For the first stop of the lift targets fit into the field of view at approximately 2600 mm

Computer Cabinets

P series



V series



T series



S series



Computer cabinet includes

- PC with an Intel/AMD processor and a Windows 10 operating system
- 21.5"+ widescreen monitor
- VESA bracket for the monitor
- Printer
- Remote control (2.4Ghz connection)
- Four brackets to store wheel adaptors

Available colours



Universal telescopic monitor bracket (for V- series and T- series)

Adjust the monitor's height and tilt to achieve best possible monitor's position at the workplace



Specifications



Parameter	TechnoVector 7		
	Measurement Range	Maximum Error	Average Error
Front axle			
Camber	±8°	±3'	±2'
Front Total Toe	±5°	±3'	±2'
Caster	±19°	±8'	±5'
SAI / KPI	±19°	±8'	±5'
Lock Angle	±45°	±10'	±5'
Rear axle			
Camber	±8°	±3'	±2'
Rear Total Toe	±5°	±3'	±2'
Rear Individual Toe	±2,5°	±3'	±2'
Symmetry angles			
Front SetBack	±2,5°	±3'	±2'
Rear SetBack	±2,5°	±3'	±2'
Thrust Angle	±2,5°	±3'	±2'
Geometrical Driving Axis	±2,5°	±3'	±2'

Marking

V 7 2 0 4 T X X X
 1 2 3 4 5 6 7 8 9

- 1 Computer cabinet series (P, V, T, S)
- 2 Wheel aligner's model generation (7 for TechnoVector 7 series)
- 3 The amount of axles measured simultaneously
- 4 1 – mobile, 0 – stationary
- 5 Total camera count
- 6 Housing type: T, H, M, K
- 7 - 8 - 9 Additional symbols for identification of different models

Delivery Set

TechnoVector 7 (Standard accessories)

1. Machine vision system	1
2. Computer cabinet	1
3. Personal computer	1
4. Set of targets	4
5. Set of wheel adaptors	4
6. Steering wheel holder	1
7. Brake lock	1
8. Set of turn tables	2
9. Remote control receiver	1
10. Remote control	1
11. Manual	1



Set of targets & clamps



Set of turn tables

Personal computer

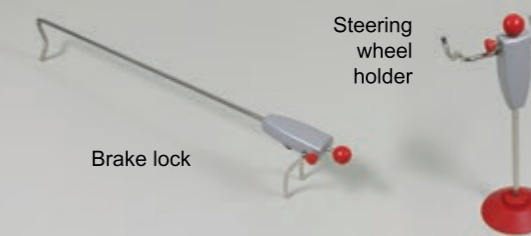

Steering wheel holder

Brake lock



Remote control

TechnoVector Software

The **TechnoVector software** is a powerful and modern application with all the tools necessary for fast and easy wheel alignment

Continuously tracks wheel positions and updates the information on screen

Database Image View



Measured values are always compared to the vehicle's specs

Target Setup

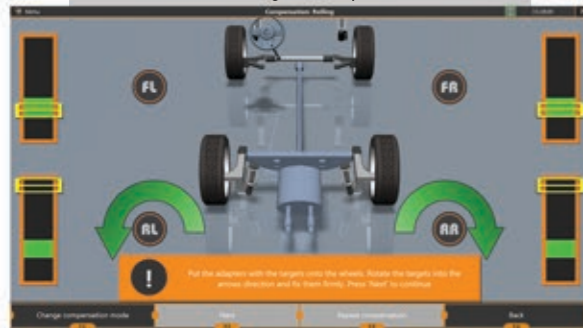

Rolling Compensation Mode



Big font and coloured value state indication help you adjust the vehicle from afar

Multiple various visualization modes to pick from



The TechnoVector software runs on a PC and uses the **Windows 10** operating system

Measurement Mode



3D Adjustment Mode



3D visualization, 7 Modes

2D Adjustment Mode



2D visualization, 2 Modes

Report View

Database

includes data for more than 60000 vehicle model:

- wheel alignment specifications
- tire pressure specifications
- 3D animation
- adjustment diagrams and images



asanetwork

The TechnoVector software supports ASA Network (a car workshop IT framework). ASA Network supports centralised order creation and data sharing across all the devices in the workshop network.



Free database updates on the TechnoVector website! Send reports to your customers via TechnoVector mobile app, e-mail or text messaging to reduce the paperwork and improve customer service

3D Animation





Configurations

Pick a configuration that fits best to your workshop needs

Up-to-date wheel aligners for modern car shops

Optima series

Light version of the Techno Vector wheel alignment system

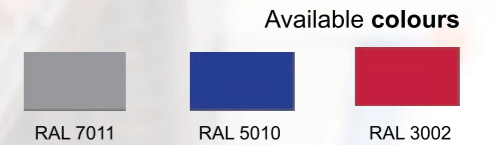

PRO series

Wheel aligners with colourful, appealing, expressive, and dynamic design



PRO Mobile series based on PRO

Move the entire wheel aligner to the place you need it to be at



Initial installation of the device

The initial installation of the equipment is performed by the manufacturer's service technicians. The device works with a 4 post wheel alignment lift or a repair pit, compliance with the horizontality requirements is strongly recommended.

Mobile App



TechnoVector Report Viewer

- Customers can use this smartphone app to gain access to the wheel alignment reports of their cars. Works on Android and iOS.
- The TechnoVector software can send the report data to the app at any time you need. The customer is identified by an e-mail address or a phone number. The wheel aligner must have an internet connection.
- If the internet connection is unavailable customers can obtain an alignment report using a QR code on the screen or in the printout.
- Reports can be viewed in the mobile app and exported as an HTML or PDF file.

Online reports

A full adjustment report can be viewed on a mobile device in the browser even without installing the TechnoVector assistant by scanning a QR-code on the screen or in the print-out. Internet connection is not required.



The TechnoVector software can send a report link to the customer via e-mail or text messaging

A print-out or a report on the tablet's screen is useful when explaining details about the alignment procedure to the customer



TechnoVector Assistant

- Take photos and perform license plate recognition, automatically filling the order data (if such data available)*.
- Take photos and attach them to the current order.
- View current wheel alignment data to the mobile device's screen. Pick one of the several modes to best fit your workflow.
- Control the wheel aligner. TechnoVector Assistant app can be used as a remote control.

* - requires an AutoFill package



Optional equipment

Additional camera

- Provides drive-in assistance
- Provides license plate recognition
- Provides vehicle presence tracking
- Allows to attach photos to the order



Order AutoCompletion packages

AutoFill package* features:

- License plate recognition
- If the vehicle is present in the customer's local database (returning customer), the vehicle model and the customer information is filled automatically

* - internet connection is required

AutoFill Plus package* features:

- License plate recognition*
- If the vehicle is present in the customer's local database (returning customer), the vehicle model and the customer information is filled automatically
- Uses TechnoVector online services** to determine the vehicle's make model and other information about the vehicle based on its license plate number***

* - internet connection is required

** - per-country availability can be checked on technovector.com

*** - information details vary depending on the country



No rights can be derived from this publication. TechnoVector reserves the right to change product specifications without prior notice. Products and services comply with the European Directives effective at the time of sale but may vary depending on the country in which you are located. For the most recent information, contact your authorised TechnoVector dealer.

Your distributor: