

www.k-electric-gmbh.de

K'ELECTRIC



PRODUCTS

📍 Also in your area.

You want to find your contact person?

We will be happy to advise you on all aspects of our product worlds.

Please use one of our contact options. We look forward to hearing from you.

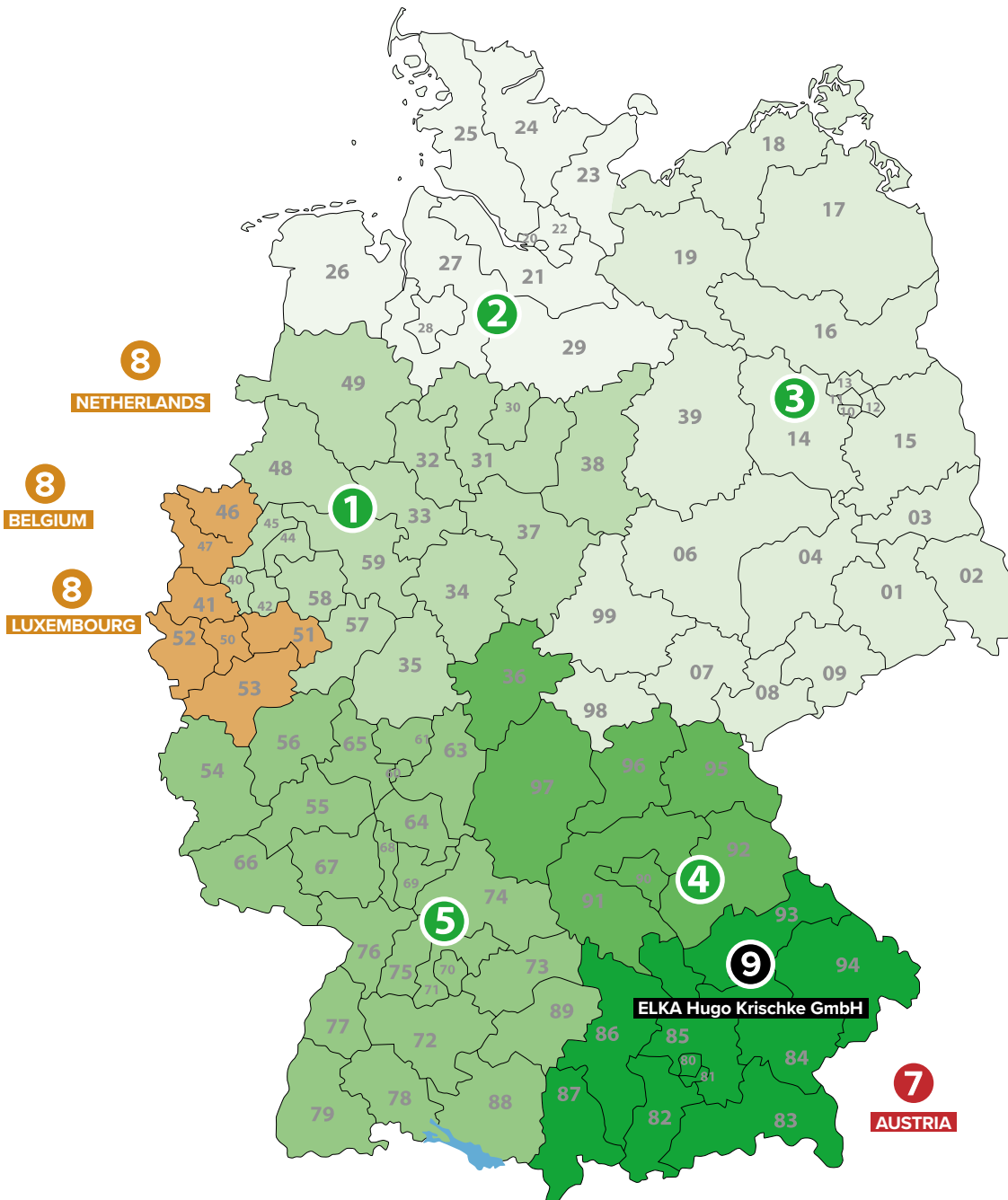

1 **Andreas Gröger**
Advice | Sales
Tel. +49 (0) 171 224 11 14
a.groeger@k-electric-gmbh.de

2 **Andreas Silling**
Advice | Sales | Product management
Tel. +49 (0) 170 899 14 04
a.silling@k-electric-gmbh.de

3 **Peter Rassel**
Advice | Sales
Tel. +49 (0) 170 910 03 31
p.rassel@k-electric-gmbh.de

4 **Klaus Lauterbach**
Advice | Sales
Tel. +49 (0) 175 686 37 69
k.lauterbach@k-electric-gmbh.de

5 **Manfred Itschner**
Advice | Sales
Tel. +49 (0) 170 931 64 20
m.itschner@k-electric-gmbh.de

6 **Philipp Stöcklein**
Key Account TGA & Energy supplier
Tel. +49 (0) 151 196 75 54 2
p.stoecklein@k-electric-gmbh.de

7 **Martin Mateyka**
Advice | Sales
Tel. +43 (0) 676 782 07 74
k-electric@bevmat.eu

8 **Christian Grün**
Advice | Sales
Tel. +49 (0) 151 177 66 89 2
c.gruen@k-electric-gmbh.de

9 **Helmut Haimerl**
Advice | Sales
Tel. +49 (0) 172 349 30 46
haimerl@elka-krischke.de

🟢 **Technical support** | support@k-electric-gmbh.de | Tel. +49 (0) 921 151 26 78 30



Welcome

to the world of

 **K'ELECTRIC**

In an era in which the energy world is characterized by ever-increasing demands for efficiency, digitalization and safety, K'ELECTRIC presents a comprehensive range of first-class solutions for safe and efficient energy distribution.

Our focus is on meeting the changing needs of the energy and control cabinet construction segment by combining proven safety systems with state-of-the-art switching technology and monitoring systems.

The integration of TYTAN® RHBUS and THBUS enables fuse failure messages to be integrated into existing control systems via Modbus. We will also show you how you can ensure optimum protection in a small space with innovative and compact surge protection devices.

In a world that is becoming increasingly complex and interconnected in the 21st century, we at K'ELECTRIC are committed every day to adapting our products to these challenges through continuous innovation.

Our goal is to develop pioneering solutions that meet the changing needs of our customers while maintaining the highest standards of safety, efficiency and reliability.

Immerse yourself in our product world and discover a wide range of state-of-the-art products that have been created for the future of energy distribution.

K'ELECTRIC

Your reliable partner for innovative solutions in a dynamic world of energy.



Photovoltaic

Infrastructure

Energy distribution

Control technology



You can rely on us!

K'ELECTRIC products are used wherever buildings, machines and systems are electrified.

In numerous innovative construction projects, we were able to play our part in ensuring safe and efficient operations in the future.

You can rely on products from K'ELECTRIC!

www.k-electric-gmbh.de



PRODUCT-HIGHLIGHTS

TYTAN Q

- ✓ D0 fuse switch-disconnector
- ✓ Width of 72mm only 4 units
- ✓ 16mm² spring terminal in the outlet
- ✓ Double terminal in input to 35mm²
- ✓ Fuse plug
- ✓ Optical fuse monitoring with flashing indicator
- ✓ All-pole switchable



ELECTRICITY METERS OF THE P-SERIE

- ✓ Digital single-phase-energy meter up to 40A direct measurement 1 unit
- ✓ Digital three-phase-energy meter up to 80A direct measurement 4 units
- ✓ Digital three-phase-energy meter up to 125A direct measurement 6 units
- ✓ Digital three-phase current transformer meter for 5 A/1 A in 4 units
- ✓ Display: Active and reactive energy, instantaneous active and reactive power (consumption and supply)
- ✓ Possible display of all relevant measurement data of the individual phases
- ✓ With adjustable transformer ratio (can be changed indefinitely)
- ✓ Two-tariff meter HT/NT (T1/T2) with tariff changeover input
- ✓ Optional expansion through communication modules
- ✓ Made in EU: with MID certification valid throughout the EU



TYTAN[®] MAIN PROTECTION

- ✓ u. a. TYTAN[®] RHBus | TYTAN[®] THBus

Fuse monitoring
with Modbus interface

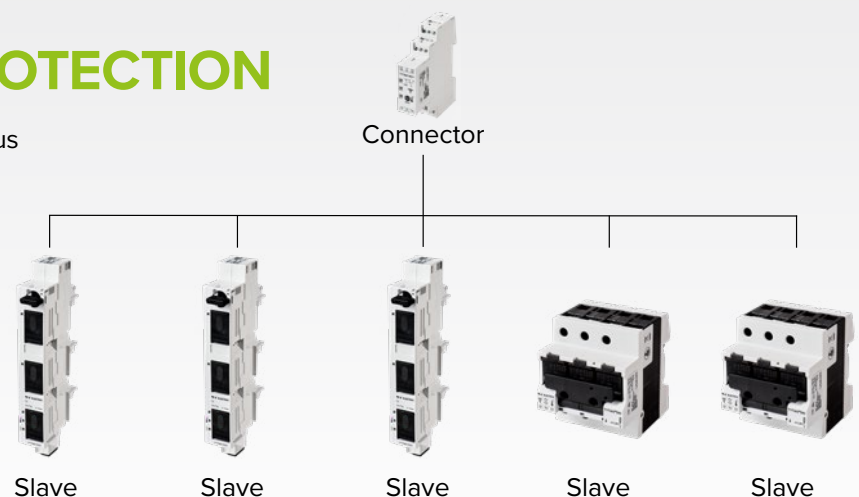



MADE BY K'ELECTRIC

25 kA combi arrester

- ✓ Integrated back-up fuse
- ✓ Narrow width: 36mm
- ✓ Low height: 105mm
- ✓ Fits into the standard DIN rail cut-out
- ✓ Short-circuit current resistance up to 100 kA



ACCESSORIES

- ✓ Distributor built-in sockets
- ✓ Cable collector
- ✓ Support insulators
- ✓ Wiring rails
- ✓ etc.

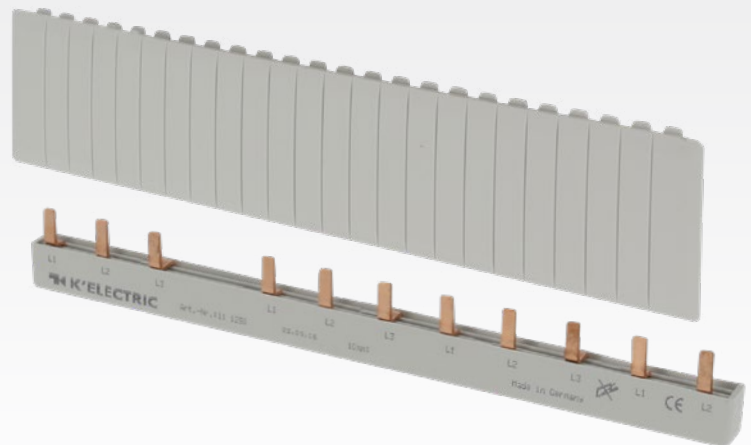

MAIN/CHANGEOVER SWITCHES

Main switches, emergency stop switches and diverter switches are essential components of electrical engineering. The emergency stop switch ensures the rapid shutdown of machines and systems in hazardous situations, while main switches serve as reliable switch-on and switch-off devices. In the field of photovoltaics and emergency power supply in particular, diverter switches have established themselves as important components and make an important contribution to the energy transition.



COMPETENCE, THAT CONVINCES

Our technical solutions are internationally accepted and characterize us as a technology leader in the field of fuse component systems.

OPTO-ELECTRONIC FLASHING INDICATOR

The patented flashing indicator acts as a modern fuse tripped indicator, an visible, reliable error message. It's immediate recognizable which fuse has tripped and the prerequisite for an immediate restart of the system.

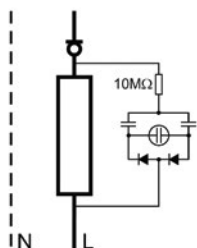

The fuse bridges the electronic control circuit.

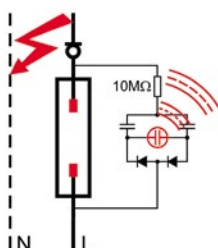

In case of a fault, the electronic circuit is triggered.

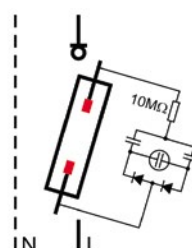

On switching off, the bridged control circuit will also be disconnected.

PLUG-IN TECHNOLOGY SAFE AND FAST

The plug-in system with extractable fuse holders ensures continuous optimum contact pressure. Screw cap designs which can get loose, contribute to an avoidable dissipation loss of up to 10VA. A quick fuse swap is possible since no cumbersome screwing-on is involved.

Plug-in and reclose. Additionally, operator safety is enhanced. The fuse plug being extractable, physical contact with the fuse, which could have a temperature of 100°C is averted.

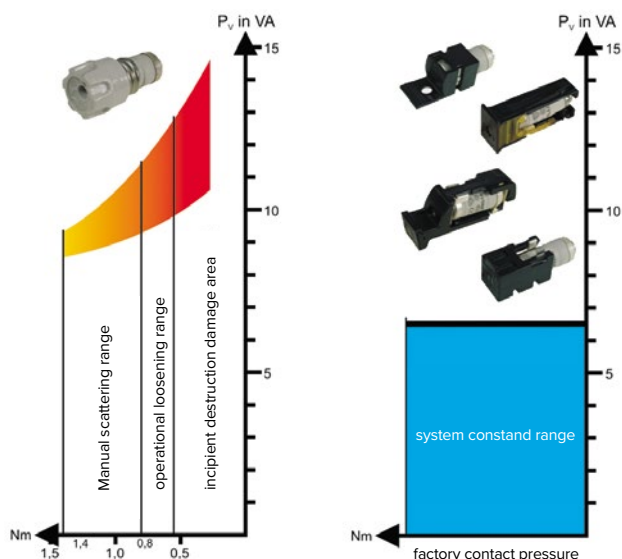

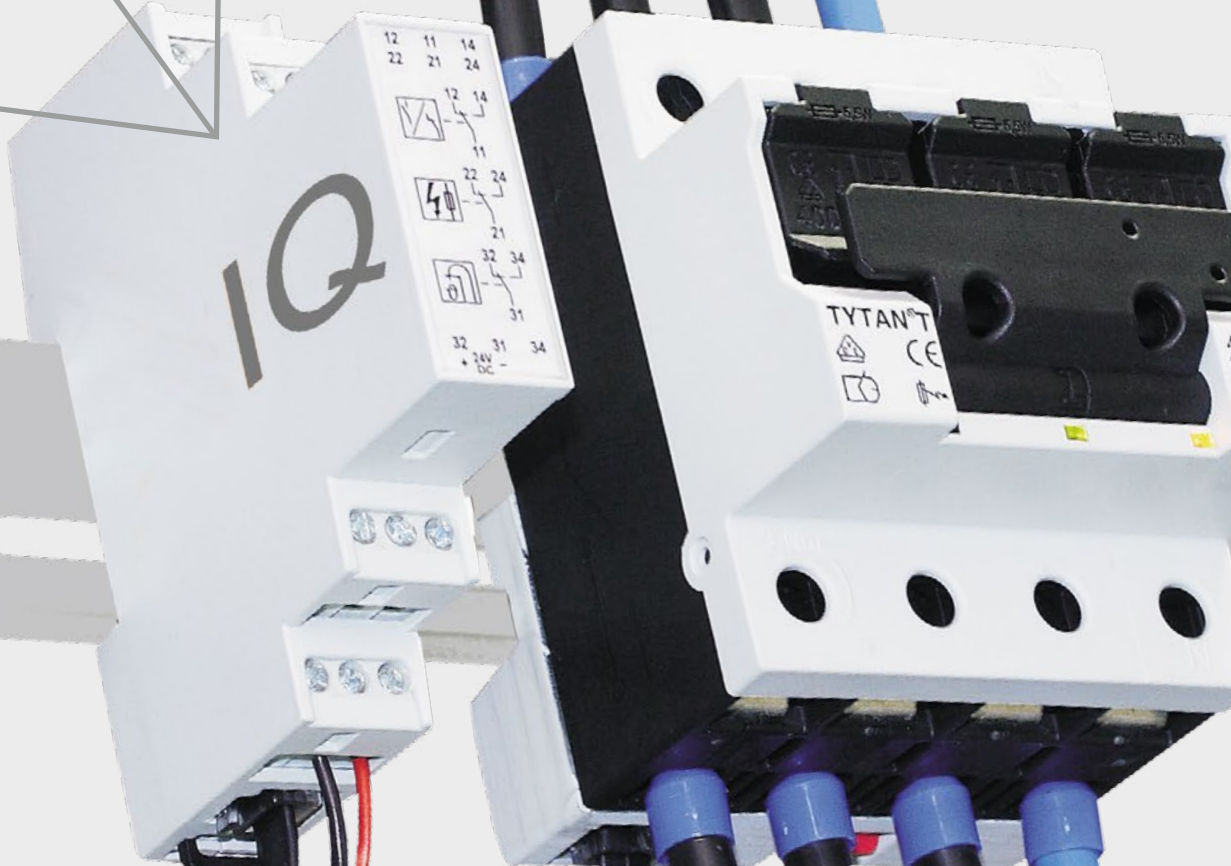
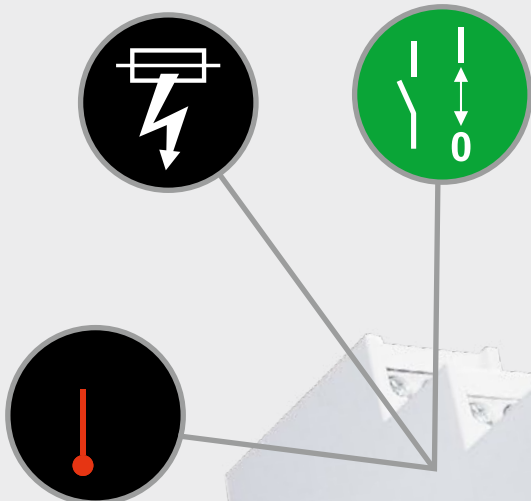

TYTAN® MAIN PROTECTION

Intelligent fuse monitoring
with Modbus interface



1

Fuse switchgear & accessoires Baseplate mounting & DIN rail systems

TYTAN® II	14
TYTAN® II main protection, fuse plugs, accessories	15
TYTAN® I	17
IN-ON	17
TYTAN® Q	18
TYTAN® T	19
TYTAN® T4P	20
TYTAN® T4H T4HP T4HR main protection	20
TYTAN® TH1 main protection	21
TYTAN® THBus	21
CORON® 2	22
CORON® DUO	23
Fuse base E14 E18	23
NH fuse switch disconnecter for baseplate mounting (series KE)	24
NH fuse switch disconnecter for baseplate mounting (MULTIBLOC®)	26

2

Fuse switchgear & accessoires Busbar system 60mm

Busbar support	32
D0 rider fuse base E18	33
Power supply I terminals	34
CORON® R	36
TYTAN® R	37
TYTAN® RH4 main protection	38
TYTAN® RH1 main protection	38
TYTAN® RHBus	39
Busbar adapter	40
TYTAN® busbar adapter	42
TYTAN® II main protection on busbar adapter	43
Three-phase compact current transformer	43
NH fuse switch disconnecter VSD	44
NH fuse switch disconnecter for panel mounting (series KE)	44
NH fuse switch disconnecter for panel mounting (MULTIBLOC®)	47
Cover system	49
PANCERO rail protection	49

3

Fuse switchgear & accessoires Busbar systems 100 mm | 185 mm

Busbar support	52
NH strip-type fuse switch disconnecter VSD	53
NH strip-type fuse switch disconnecter EVO	56
NH strip-type fuse switch disconnecter MULTIVERT®	57
Connection lugs	60
Direct connection V frame terminals	60
Insulation caps	60
Insert nuts / setting nuts	60
System strip	61

4

Switchgear for cylindrical fuses

Cylinder fuse holder (10x38mm / 14x51mm / 22x58mm)	64
PV fuse holder	65
Cylinder fuse holder Class J	66
Cylinder fuse holder Class CC	67

5

Fuses & accessories

D0 fuse links	70
Spar click box	70
D0 cartridge ring adapter inserts	71
D0 screw caps	71
NH fuse links	72
NH cutting knife	75
Cylindrical fuse links	76
Cylindrical fuse links for photovoltaics	77

6

Main & emergency stop switches & accessories

Fixing options	80
Emergency stop switches (NAS)	81
Main switches (HS)	84
Diverter switches (LUS)	87
Auxiliary switches	88
Repair switches (RS)	88
Neutral wire	89
Accessories	90

OUR PRODUCTS



You can rely on our products.
At any times. Highest product
availability and on-time delivery
for your safety ...

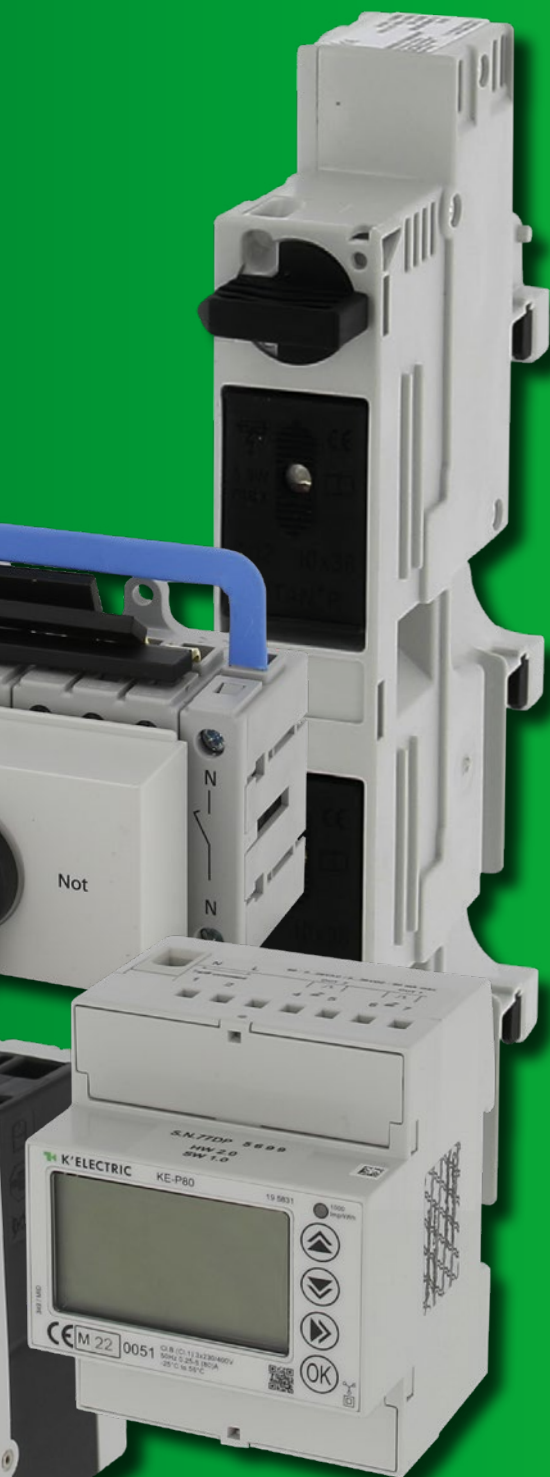

Measuring relay technology

Under-voltage relay – standard.....	94
Under-voltage relay with extended range of functions.....	94
Under-voltage relay with rotating field detection.....	95
Under-voltage relay – adjustable.....	95
Under-/ over-voltage relay.....	96
Under-/ over-voltage relay DC.....	96
Phase indicator.....	97
Mains monitoring measurement relay.....	97



Digital measuring devices, current transformers & accessories

P-series electricity meter.....	100
LAN server MOD-Bus TCP data concentrator.....	101
Multifunction meter Krypton E3.....	102
Multifunction meter Krypton E5.....	102
Multifunction meter Krypton E10.....	103
Multifunction meter Krypton H10.....	103
Plug-in current transformer.....	104
Conversion current transformer.....	106
Three-phase compact current transformer.....	107
Plug'n-wire-multifunction meter Krypton E20.....	108
Plug'n-wire-multifunction meter Krypton H20.....	108
Three-phase current transformer for the plug'n-wire system.....	109



Plug-in meter terminals

ADOCK® plug-in meter terminal 63A.....	112
ADOCK® plug-in meter terminal 100A.....	113



Wiring rails & accessories

Pin wiring rails.....	116
Fork wiring rails.....	123
Accessories (matching end caps, touch protection).....	127



Lightning & surge protection

Selection guide.....	130
40mm system (meter cupboard)	
GT40, GTN40, GT E.....	132
60mm system.....	134
Combined arrester for the DIN rail	
GT 1+2.....	135
Type 2+3 surge protection	
GT T2, GT 2+3, electromobility.....	136
FM.....	137
PV.....	138
Generator connection box (GAK).....	140



Switch cabinet accessories

Blind cover, blank panel, lock.....	144
Low angle brackets, DIN rail spacer, DIN flat rails.....	145
DIN rail socket, support insulators.....	146
Service box for the DIN rail.....	147
TYTAN® II service box for the DIN rail (incl. print).....	147
Document pockets.....	148
Cable collector for switch cabinet construction.....	149





TYTAN® TH1

Fuse switchgear & accessories

Baseplate mounting & DIN rail systems



D0 fuses are the most frequently used protective devices in Europe. Modern fuse switching devices enable convenient and, above all, safe use of these fuses. Our D0 fuse-switches stand for high operating safety, IEC conformity and the highest product quality. Our flashing indicators are a 100% guaranteed fuse monitoring – as standard. State-of-the-art monitoring electronics provide all relevant information for the system operator.

TYTAN® II

D0 fuse switch disconnecter

Nominal current unmistakability due to full coding (1–63A). The TYTAN® system codes consistently for all amperage levels. Also between the new stages 13, 32 and 40A.

- ✓ Flashing indicator (in plug)
- ✓ Fuse plug
- ✓ Full coding for ALL current levels
- ✓ Sealable
- ✓ Lockable

Item	Item no.	PU
TYTAN II D0 fuse switch disconnecter 1-pole	102651	12
TYTAN II D0 fuse switch disconnecter 2-pole	102652	6
TYTAN II D0 fuse switch disconnecter 3-pole	102653	4
TYTAN II D0 fuse switch disconnecter 3-pole with PEN terminal	102649	3

***Delivered without fuse plug!**



102653

Item	Item no.	PU
TYTAN II D0 fuse switch disconnecter 1-pole + N	102641	6
TYTAN II D0 fuse switch disconnecter 3-pole + N	102643	3

***Delivered without fuse plug!**



102641



102643

Item	Item no.	PU
TYTAN II D0 fuse switch disconnecter 1-pole + N + auxiliary switch for switching position	102841	4
TYTAN II D0 fuse switch disconnecter 3-pole + N + auxiliary switch for switching position	102843	2
TYTAN II D0 fuse switch disconnecter 1-pole + auxiliary switch for switching position	102851	6
TYTAN II D0 fuse switch disconnecter 2-pole + auxiliary switch for switching position	102852	4
TYTAN II D0 fuse switch disconnecter 3-pole + auxiliary switch for switching position	102853	3

***Delivered without fuse plug!**



102851



102853

Item	Item no.	PU
TYTAN II D0 fuse switch disconnecter 3-pole incl. fuse 25A and fixed fitting rings	102653.24ABF25	4
TYTAN II D0 fuse switch disconnecter 3-pole incl. fuse 35A and fixed fitting rings	102653.24ABF35	4
TYTAN II D0 fuse switch disconnecter 3-pole incl. fuse 40A and fixed fitting rings	102653.24ABF40	4
TYTAN II D0 fuse switch disconnecter 3-pole incl. fuse 50A and fixed fitting rings	102653.24ABF50	4

***Delivered without fuse plug!**



102653.24ABF25



102653.24ABF50

TYTAN® II main protection

D0 fuse switch disconnecter with fuse monitoring relay

Nominal current unmistakability due to full coding. The TYTAN® system codes consistently for all amperage levels. Also between the new stages 13, 32 and 40A.

- ✓ Flashing indicator (in plug)
- ✓ Sealable and lockable
- ✓ Full coding for ALL current levels
- ✓ Fuse plug

Item	Item no.	PU
TYTAN II main protection 1-pole, 60-230/400V AC / 60-110V DC	102751	6
TYTAN II main protection 2-pole, 60-230/400V AC / 60-220V DC	102752	4
TYTAN II main protection 3-pole, 60-230/400V AC	102753	3

Item	Item no.	PU
TYTAN II main protection 1-pole + N, 60-230/400V AC	102741	4
TYTAN II main protection 3-pole + N, 60-230/400V AC	102743	2

Item	Item no.	PU
TYTAN II main protection 1-pole, 24-60V AC/DC	102711	6
TYTAN II main protection 2-pole, 24-60V AC/DC	102712	4
TYTAN II main protection 3-pole, 24-60V AC/DC	102713	3

*Delivered without fuse plug!

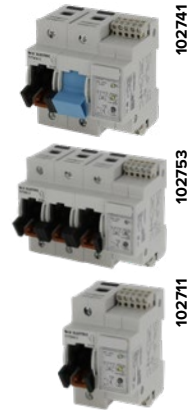

TYTAN® II fuse plugs in set

- ✓ For equipping TYTAN® II fuse switch disconnecter and main protection incl. fuse link
- ✓ 1 set: 3x fuse plugs incl. safety insert, 3x pass insert, spar click box

Item	Color	Item no.	Item no.	PU
		50-250V DC, 50-400V AC	24-60V DC	
TYTAN II fuse plugs 1A	orange	102601	102401	1
TYTAN II fuse plugs 2A	orange-brown	102602	102402	1
TYTAN II fuse plugs 4A	grey-brown	102604	102404	1
TYTAN II fuse plugs 6A	green	102606	102406	1
TYTAN II fuse plugs 10A	pink	102610	102410	1
TYTAN II fuse plugs 13A	black	102613	102413	1
TYTAN II fuse plugs 16A	grey	102616	102416	1
TYTAN II fuse plugs 20A	blue	102620	102420	1
TYTAN II fuse plugs 25A	yellow	102625	102425	1
TYTAN II fuse plugs 32A	purple	102632	102432	1
TYTAN II fuse plugs 35A	black	102635	102435	1
TYTAN II fuse plugs 40A	brown	102640	102440	1
TYTAN II fuse plugs 50A	white	102650	102450	1
TYTAN II fuse plugs 63A	dark brown	102663	102463	1

*Individual plugs can be found on the next page

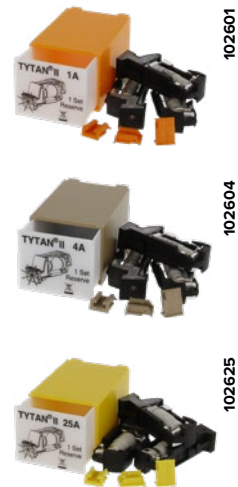

TYTAN® II fuse plugs – single

Item	Color	Item no.	Item no.	PU
		50-250V DC, 50-400V AC	24-60V DC	
TYTAN II fuse plug 1A	orange	102601/1		1
TYTAN II fuse plug 2A	orange-brown	102602/1	102402/1	1
TYTAN II fuse plug 4A	grey-brown	102604/1	102404/1	1
TYTAN II fuse plug 6A	green	102606/1	102406/1	1
TYTAN II fuse plug 10A	pink	102610/1	102410/1	1
TYTAN II fuse plug 13A	black	102613/1	102416/1	1
TYTAN II fuse plug 16A	grey	102616/1	102420/1	1
TYTAN II fuse plug 20A	blue	102620/1	102425/1	1
TYTAN II fuse plug 25A	yellow	102625/1	102432/1	1
TYTAN II fuse plug 32A	purple	102632/1	102435/1	1
TYTAN II fuse plug 35A	black	102635/1	102440/1	1
TYTAN II fuse plug 40A	brown	102640/1	102450/1	1
TYTAN II fuse plug 63A	dark brown	102663/1	102463/1	1



TYTAN® II – Accessories

Short-circuit plug as cutting knife, 1 set = 3 pieces

Item	Item no.	PU
TYTAN II short-circuit plug with print: "blind plug"	102300-1	1
TYTAN II short-circuit plug with print: electric flash white	102300-2	1
TYTAN II short-circuit plug with print: „cutting knife“	102300-3	1



Reclosing lockout in clickbox for DIN rail

Item	Color	Item no.	PU
Reclosing lockout cylindrical lock 5A5	schwarz	102007-1	1
Reclosing lockout cylindrical lock 5A4	blau	102007-2	1
Reclosing lockout cylindrical lock 5A3	grün	102007-3	1
Reclosing lockout cylindrical lock 5A1	gelb	102007-4	1
Reclosing lockout cylindrical lock 5A2	rot	102007-5	1
Reclosing lockout plastic lock	schwarz	102008-1	1
Reclosing lockout plastic lock	blau	102008-2	1
Reclosing lockout plastic lock	grün	102008-3	1
Reclosing lockout plastic lock	gelb	102008-4	1
Reclosing lockout plastic lock	rot	102008-5	1



Item	Item no.	PU
TYTAN II double terminal 3 x 2 x 35mm ²	102013	4



Dummy

Item	Item-no.	PU
TYTAN II dummy (empty fuse plug) without flashing indicator	102300	1



TYTAN® I

D01 fuse switch disconnecter

- ✓ Flashing indicator
- ✓ Universal fuse plug
- ✓ Connection width 1 unit per pole
- ✓ LS switch compatible
- ✓ No fitting sleeves necessary
- ✓ 2 – 16A

Item	Item no.	PU
TYTAN I D01 fuse switch disconnecter 1-pole	101651	12
TYTAN I D01 fuse switch disconnecter 2-pole	101652	6



Item	Item no.	PU
TYTAN I D01 fuse switch disconnecter 3-pole	101653	4



Item	Item no.	PU
TYTAN I D01 fuse switch disconnecter 1-pole + N	101641	6
TYTAN I D01 fuse switch disconnecter 3-pole + N	101643	3



IN-ON

D0- fuse switch disconnecter

- ✓ Flashing indicator
- ✓ Universal fuse plug
- ✓ Sealable and lockable
- ✓ Triggered by push button
- ✓ 2 – 63A

Item	Item no.	PU
IN-ON D0 fuse switch disconnecter 1-pole	101771	12
IN-ON D0 fuse switch disconnecter 1-pole incl. fuse 10A	101773	12
TYTAN R / CORON R / TYTAN T / CORON DUO plug reducing spring from D01 to D02	101774	12



Accessories

Item	Item no.	PU
TYTAN T, TYTAN R and IN-ON shorting bolt	101780	3

TYTAN® Q

D0 fuse switch disconnecter

- ✓ Construction width of 72mm only 4 units/1-pole 2 units
- ✓ 16mm² spring terminals in the outlet
- ✓ Double terminal in the input until 35mm²
- ✓ Universal fuse plug
- ✓ Optical fuse monitoring with flashing indicator
- ✓ All-pole switchable

TYTAN® Q 400VAC[~], D0: 2 – 63A

Item	Item no.	PU
TYTAN Q 1-pole + N, 2 units	103315	6



Item	Item no.	PU
TYTAN Q 3-pole, 4 units	103313	3



Item	Item no.	PU
TYTAN Q 3-pole + N, 4 units	103316	3
TYTAN Q 3-pole + auxiliary switch, 4 units	103317	3



Accessories

Item	Item no.	PU
Padlock in the click box	104664	1
Plug reducing spring for D01 fuses	103321	12

TYTAN® T

Fuse switch disconnecter for D0 and cylindrical fuses 10x38mm

- ✓ Construction width of 72mm only 4 units
- ✓ 25mm² frame terminals
- ✓ Universal fuse plug
- ✓ Optical fuse monitoring with flashing indicator
- ✓ All-pole switchable

TYTAN® T, 400V[~], D0: 2 – 63A, 10x38mm: 2 – 32A

Item	Item no.	PU
TYTAN TF D0 fuse switch disconnecter 3-pole, 4 units wide	104213	3
TYTAN TF D0 fuse switch disconnecter 3-pole + N, 4 units wide	104215	3
TYTAN TF D0 fuse switch disconnecter 3-pole with auxiliary switch, 4 units wide	104217	3



TYTAN® T, 500V[~], 10x38mm: 2 – 25A

Item	Item no.	PU
TYTAN T fuse switch disconnecter 3-pole for cylindrical fuses 10x38	104383	3
TYTAN T fuse switch disconnecter 3-pole + N for cylindrical fuses 10x38	104385	3
TYTAN T fuse switch disconnecter 3-pole + auxiliary switch for cylindrical fuses 10x38	104387	3



Accessories

Item	Item no.	PU
TYTAN R / CORON R / TYTAN T / TYTAN Q / CORON DUO plug reducing spring from D01 to D02	101774	12
Padlock in the click box	104664	1
TYTAN T, TYTAN R and IN-ON shorting bolt	101780	3

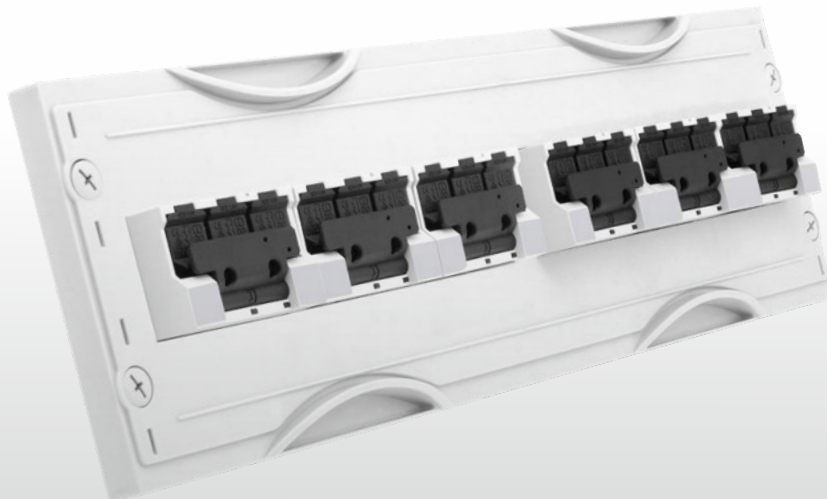

TYTAN® T4P

Additionally with optical phase and rotating field display

400VAC[~], D0: 2 – 63A, 10 x 38mm: 2 – 32A

Item	Item no.	PU
TYTAN T4P 3-pole+ N; with 3-fold phase indicator and flashing indicator	104255	3
TYTAN T4P 3-pole+ N; with 3-fold phase indicator and flashing indicator, equipped with 20A fuses	104255.20	3
TYTAN T4P 3-pole + N; with 3-fold phase indicator and flashing indicator, equipped with 25A fuses	104255.25	3
TYTAN T4P 3-pole + N; with 3-fold phase indicator and flashing indicator, equipped with 35A fuses	104255.35	3
TYTAN T4P 3-pole + N; with 3-fold phase indicator and flashing indicator, equipped with 40A fuses	104255.40	3
TYTAN T4P 3-pole + N; with 3-fold phase indicator and flashing indicator, equipped with 50A fuses	104255.50	3



104255

TYTAN® T4H | T4HP | T4HR main protection

with signaling contact for fuse failure, phase failure and overtemperature

- ✓ Only 4 units wide
- ✓ Flashing indicator
- ✓ Universal fuse plug
- ✓ Potential-free changeover contact for: Fuse, phase and temperature monitoring of the 3-phases

400V[~] – with signaling contact for fuse failure – phase failure & overtemperature

Item	Item no.	PU
TYTAN T4H D0 fuse switch disconnecter 3-pole, 4 units wide with fuse monitoring	104233	4
TYTAN T4H D0 fuse switch disconnecter 3-pole + N, 4 units wide with fuse monitoring	104235	4



104233

400V[~] – with signaling contact for fuse failure & overtemperature – no signaling for phase failure

Item	Item no.	PU
TYTAN T4HR D0 fuse switch disconnecter 3-pole, 4 units wide with fuse monitoring	104263	4
TYTAN T4HR D0 fuse switch disconnecter 3-pole + N, 4 units wide with fuse monitoring	104265	4
TYTAN T4HR D0 fuse switch disconnecter 3-pole, 4 units wide with fuse monitoring and HS	104267	4



104265

Accessories

Item	Item no.	PU
TYTAN R / CORON R / TYTAN T / CORON DUO plug reducing spring from D01 to D02	101774	12
Padlock in the click box	104664	1
TYTAN T, TYTAN R and IN-ON shorting bolt	101780	3



101774



101780

TYTAN® TH1 main protection

with signal relay for fuse and temperature monitoring

TYTAN® main protection signals fuse cut-outs and forwards them to the external relay unit via an RJ connection cable. At the same time, dangerous overheating of the switching device is also indicated and reported. A potential-free changeover contact is available as an interface on the relay section. As a collective fault signal, up to 12 switching devices can be monitored together by connecting them in series.

- ✓ Fuse and temperature monitoring
- ✓ Potential-free relay contacts

400V~, D0: 2 – 63A; 10 x 38: 2 – 32A

Item	Item no.	PU
TYTAN TH1 main protection 3-pole, D0 fuse switch disconnecter 3-pole, 4 units wide	104703	3
TYTAN TH1 main protection 3-pole + N, D0 fuse switch disconnecter 3-pole, 4 units wide	104705	3



Accessories

Item	Item no.	PU
Main protection relay module HR11, 3 changer	103711	1
Main protection relay module HR12, 2 changer	103712	1
Main protection relay module HR13, 1 changer	103713	1
RJ connection cable 200mm	103730	1
RJ connection cable 500mm	103731	1
RJ connection cable 1000mm	103732	1
RJ connection cable 1500mm	103733	1



TYTAN® THBus

Fuse and temperature monitoring with Modbus interface

- ✓ Detailed fuse monitoring for up to 28 devices via Modbus RTU interface
- ✓ Checking the individual temperatures and switching positions



Item	Item no.	PU
TYTAN THBus main protection 3-pole, D0 fuse switch disconnecter 3-pole, 4 units wide	101803	4
TYTAN THBus main protection 3-pole + N, D0 fuse switch disconnecter 3-pole + N, 4 units wide	101804	4
Power supply unit 100-230VAC / 24V DC / 10VA	103700	1



Accessories

Item	Item no.	PU
Modbus connector	101830	1
Termination resistor RJ11	101839	1
RJ connection cable 200mm	103730	1
RJ connection cable 500mm	103731	1
RJ connection cable 1000mm	103732	1
RJ connection cable 1500mm	103733	1



CORON® 2

D0 fuse switch disconnecter

- ✓ Flashing indicator
- ✓ Universal fuse plug
- ✓ Sealable
- ✓ Lockable with padlock

Item	Item no.	PU
CORON 2 D0 fuse switch disconnecter 1-pole	104651	12
CORON 2 D0 fuse switch disconnecter 2-pole	104652	6
CORON 2 D0 fuse switch disconnecter 3-pole	104653	4



104653AF25

Item	Item no.	PU
CORON 2 D0 fuse switch disconnecter 1-pole + N	104641	6
CORON 2 D0 fuse switch disconnecter 3-pole + N	104643	3



104641

Item	Item no.	PU
*CORON 2 D0 fuse switch disconnecter 3-pole, incl. fuse 25A and fixed fitting rings	104653AF25	4
*CORON 2 D0 fuse switch disconnecter 3-pole, incl. fuse 35A and fixed fitting rings	104653AF35	4
*CORON 2 D0 fuse switch disconnecter 3-pole, incl. fuse 40A and fixed fitting rings	104653AF40	4
*CORON 2 D0 fuse switch disconnecter 3-pole, incl. fuse 50A and fixed fitting rings	104653AF50	4

*Supplied with safety inserts and fixed inserts

Accessories

Item	Item no.	PU
Padlock in the click box	104664	1
CORON 2 reducing spring for D01 fuse plugs 2...16A	104601	12



104664

CORON® DUO

D0 fuse switch disconnecter incl. fuse plug with flashing indicator

- ✓ Connection width of 27mm per pole
- ✓ Mechanical contact position indicator
- ✓ With integrated auxiliary switch (optional)
- ✓ Easy fuse replacement thanks to fuse plug with finger protection
- ✓ Sealable
- ✓ Feed-in on both sides
- ✓ Double terminal

Item	Item no.	PU
CORON DUO D0 fuse switch disconnecter 1-pole	103301	12
CORON DUO D0 fuse switch disconnecter 2-pole	103302	6
CORON DUO D0 fuse switch disconnecter 3-pole	103303	4
CORON DUO D0 fuse switch disconnecter 4-pole	103304	3



Item	Item no.	PU
CORON DUO D0 fuse switch disconnecter 1-pole + N	103305	6
CORON DUO D0 fuse switch disconnecter 3-pole + N	103306	3



Item	Item no.	PU
CORON DUO D0 fuse switch disconnecter 3-pole + auxiliary switch	103307	3

Item	Item no.	PU
CORON DUO D0 fuse switch disconnecter 3-pole	103303AF25	4
CORON DUO D0 fuse switch disconnecter 3-pole	103303AF35	4
CORON DUO D0 fuse switch disconnecter 3-pole	103303AF40	4
CORON DUO D0 fuse switch disconnecter 3-pole	103303AF50	4

Accessories

Item	Item no.	PU
TYTAN R / CORON R / TYTAN T / CORON DUO plug reducing spring from D01 to D02	101774	12



Fuse base

D0 fuse base E14 | E18

- ✓ Touch-protected version
- ✓ Simple labeling option
- ✓ Double terminal in the input
- ✓ Current strength D01: 2 – 16A
- ✓ Current strength D02: 2 – 63A

Item	Item no.	PU
D01 fuse base E14, 1-pole	284001	15
D01 fuse base E14, 3-pole	284003	5
D01 fuse base E18, 1-pole	284011	15
D01 fuse base E18, 3-pole	284013	5



Accessories

Item	Item no.	PU
Screw cap D02 plastic with test hole	126024	20
Screw cap D01 plastic with test hole	126025	20
Screw cap D02 porcelain with test hole	127024	20
Screw cap D01 porcelain with test hole	127025	20
Plug reducing spring for D01 fuses	121401	20



NH fuse switch disconnecter for baseplate mounting series KE

- ✓ Cover sealing
- ✓ Integrated window lock

NH 000 AT / series KE, 3-pole, 125A / 690V

Item	Item no.	PU
NH 000 AT 125A, 3-pole, KE construction width 53mm	202010	1
Indicator switch set for switching position NH 000 KE	200852/000	1
Mounting set for DIN rails 125mm for item 202010	200151	1
Mounting set for DIN rails 150mm for item 202010	200152	1



NH 00 AT, series KE, 3-pole, 160A / 690V

Item	Item no.	PU
NH 00 AT KE 160A, 3-pole, clip terminal clamps 4-70 mm ²	203010	1
NH 00 AT KE 160A, 3-pole, connection screw M8	203011	1
NH 00 AT KE 160A, 3-pole, V connection	203015	1
NH 00 AT KE 160A, 3-pole, with electronic fuse monitoring, clip terminal clamps 4-70 mm ²	203070	1
NH 00 AT KE 160A, 3-pole, with 6 clip terminal clamps 4-70 mm ² , with fuse monitoring/ RJ interface for the main protection system	203076	1



Accessories

Item	Item no.	PU
Mounting set for DIN rails 125mm	200153	1
Mounting set for DIN rails 150mm	200154	1
Terminal cover size 00	200148	1
Indicator switch for switching position NH 00 KE	200852	1
Terminals AL/Cu 1.5-70 mm ² (1 set = 3 pieces)	208053	1



NH 1 AT, series KE 3-pole, 250A / 690V

Item	Item no.	PU
NH 1 AT KE 250A, 3-pole, connection screw M10	203110	1
Prism terminal 70-150mm ²	200420	3
Terminal cover size 1	201148	1
Indicator switch for switching position NH1/2/3 series KE	201852	1
NH 1 AT KE 250A, 3-pole, with electronic fuse monitoring, connection screw M10	203170	1
NH 1 AT 250A, 3-pole, 6 connection screws M10, with fuse monitoring with RJ interface for the main protection system	203176	1

**NH 2 AT, series KE 3-pole, 400A / 690V**

Item	Item no.	PU
NH 2 AT KE 400A, 3-pole, connection screw M10	203210	1
NH 2 AT KE 400A, 3-pole, with electronic fuse monitoring, connection screw M12	203270	1
NH 2 AT 400A, 3-pole, connection screw M12, with electronic fuse monitoring and RJ interface for the main protection system	203276	1
Prism terminal 120-240mm ²	201237	1
Terminal cover size 2	202148	1
Indicator switch for switching position NH1/2/3 series KE	201852	1

**NH 3 AT, series KE 3-pole, 630A / 690V**

Item	Item no.	PU
NH 3 AT KE 630A, 3-pole, connection screw M12	203310	1
Terminal cover size 3	203148	1



NH fuse switch disconnecter for baseplate mounting MULTIBLOC®

- ✓ Mounting on the mounting plate
- ✓ Modular system: Covers for distributor installation
- ✓ Parking position of the gear shift cover
- ✓ Cover locking and sealing

MULTIBLOC® NH 00 AT, 1-pole, 2-pole, 160A / 690V

Item	Item no.	PU
NH 00 AT Multibloc 160A, 1-pole, clip terminal clamps 4-70 mm ²	143019	1
NH 00 AT Multibloc 160A, 2-pole, connection screw M8	143018	1
Cable cover NH 00 1-pole (1 set = 2 pieces)	140149	1
DIN mounting 125mm 1-pole for NH 00 AT	140151	1
DIN mounting 150mm 1-pole for NH 00 AT	140152	1



MULTIBLOC® NH 00 AT, 3-pole, 160A / 690V

Item	Item no.	PU
NH 00 AT Multibloc 160A, 3-pole, clip terminal clamps 4-70 mm ²	143010	1
NH 00 AT Multibloc 160A, 3-pole, 6x connection screws M8	143011	1
NH 00 AT Multibloc 160A, 3-pole, with electronic fuse monitoring, clip terminal clamps 4-70 mm ²	143070	1



3-pole+N, 160A / 690V (incl. N cutting knife)

Item	Item no.	PU
NH 00 AT Multibloc 160A, 3-pole + N, connection screw M8	143090	1
Cover 1-fold NH 00 4-pole/3+N, 220 x 240mm	142764	1



Accessories

Item	Item no.	PU
Indicator switch for switching position	140852	1
Cable cover NH 00 3-pole (1 set = 2 pieces)	140148	1
DIN mounting 125mm 3-pole for NH 00 AT	140153	1
DIN mounting 150mm 3-pole for NH 00 AT	140154	1

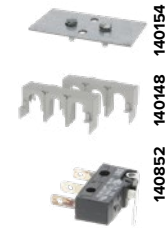

Item	Item no.	PU
Cover 1-fold NH 00 3-pole, 123 x 190mm	140126	1
Cover 2-fold NH 00 3-pole, 231 x 190mm	140127	1
Cover 3-fold NH 00 3-pole, 339 x 190mm	140128	1
Cover 1-fold NH 00 3-pole with 1-fold empty field cover, 231 x 210mm	142870	1
Cover 2-fold NH 00 3-pole, 231 x 210mm	142874	1
Cover 1-fold NH 00 3-pole, 123 x 210mm	143431	1
Sealing set	140155	1
Clip terminal clamps Cu 4-70 mm ² (1 set = 3 pieces)	148051	1
Connection screws M8 (1 set = 3 pieces)	148052	1
Terminals AL/Cu 1.5-70 mm ² (1 set = 3 pieces)	148053	1

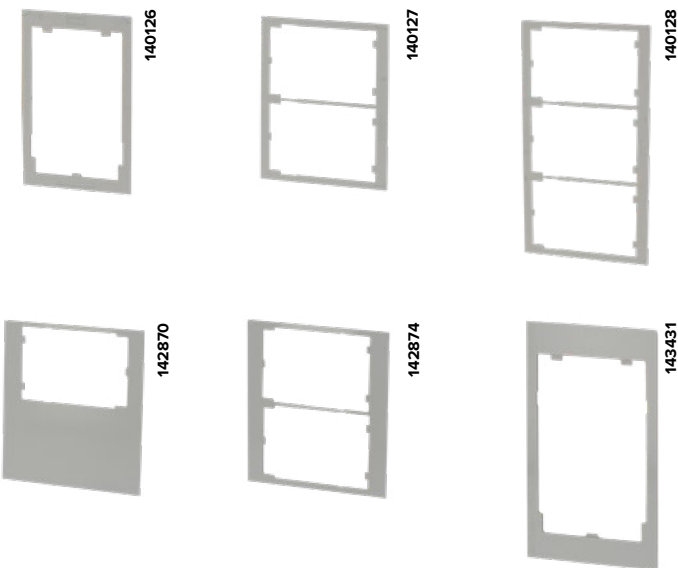

MULTIBLOC® NH 1 AT, 1-pole, 2-pole, 250A / 690V

Item	Item no.	PU
NH 1 AT Multibloc 250A, 2-pole, connection screw M10	143118	1
NH 1 AT Multibloc 250A, 1-pole, connection screw M10	143119	1

**Accessories**

Item	Item no.	PU
Cable cover (1 set = 2 pieces) for NH 1, 1-pole	140354	1
DIN mounting 125mm, NH 1, 1-pole und 2-pole	140402	1
DIN mounting 150mm, NH 1, 3-pole	140403	1
Sealing set	140155	1
Indicator switch for switching position	140852	1

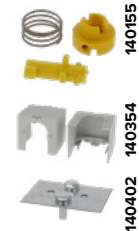
**MULTIBLOC® NH 1 AT, 3-pole, 250A / 690V**

Item	Item no.	PU
NH 1 AT Multibloc 250A, 3-pole, connection screw M10	143110	1
NH 1 AT Multibloc 250A, 3-pole, with electronic fuse monitoring, connection screw M10	143170	1

**Accessories**

Item	Item no.	PU
Clip terminal clamps 70-150 mm ² (1 set = 3 pieces)	140420	1
Indicator switch for switching position	140852	1
Cable cover NH 1 (1 set = 2 pieces)	140382	1
Cover 1-fold NH 13-pole, 210 x 260mm	140353	1
Cover 1-fold NH 13-pole, 230 x 283mm	142351	1
Sealing set for NH 00 and NH 1	140155	1
Busbar adapter for NH 1 AT to the 100mm busbar system	140491	1

**MULTIBLOC® NH 1 AT, 3-pole+N, 250A / 690V**

Item	Item no.	PU
NH 1 AT Multibloc 250A, 3-pole + N, connection screw M10	143190	1



MULTIBLOC® NH 2 AT, 3-pole, 400A / 690V

Item	Item no.	PU
NH 2 AT Multibloc 400A, 3-pole, connection screw M10	143210	1
NH 2 ATr Multibloc 400A, 3-pole, with electronic fuse monitoring, connection screw M10	143270	1



143210

Accessories

Item	Item no.	PU
Clip terminal clamps 120-240 mm ² (1 set = 3 pieces)	141237	1
Indicator switch for switching position	140852	1
Cable cover NH 2 (1 set = 2 pieces)	140861	1
Cover 1-fold NH 2, 3-pole, 230 x 300mm	140863	1
Cover 1-fold NH 2 3-pole, 234 x 310mm	142352	1
Busbar adapter for NH 2 AT to the 100mm busbar system	140492	1



141237



140852



140861



140863



142352



140492

MULTIBLOC® NH 3 AT, 3-pole, 630A / 690V

Item	Item no.	PU
NH 3 AT Multibloc 630A, 3-pole, connection screw M12	143310	1
NH 3 AT Multibloc 630A, 3-pole, with electronic fuse monitoring, connection screw M12	143370	1



143310

Accessories

Item	Item no.	PU
Clip terminal clamps 150-300 mm ² (1 set = 3 pieces)	141238	1
Indicator switch for switching position	140852	1
Cable cover (1 set = 2 pieces) for NH3	140893	1
Busbar adapter for NH 3 AT to the 60mm busbar system (1 set = 3 pieces)	140490	1
Busbar adapter for NH 3 AT to 100mm busbar system	140493	1
Cover 1-fold NH 3 3-pole, 287 x 330mm	142353	1



141238



140852



140893



140490



140493



142353



60 system

Fuse switchgear & accessories

Busbar system 60mm

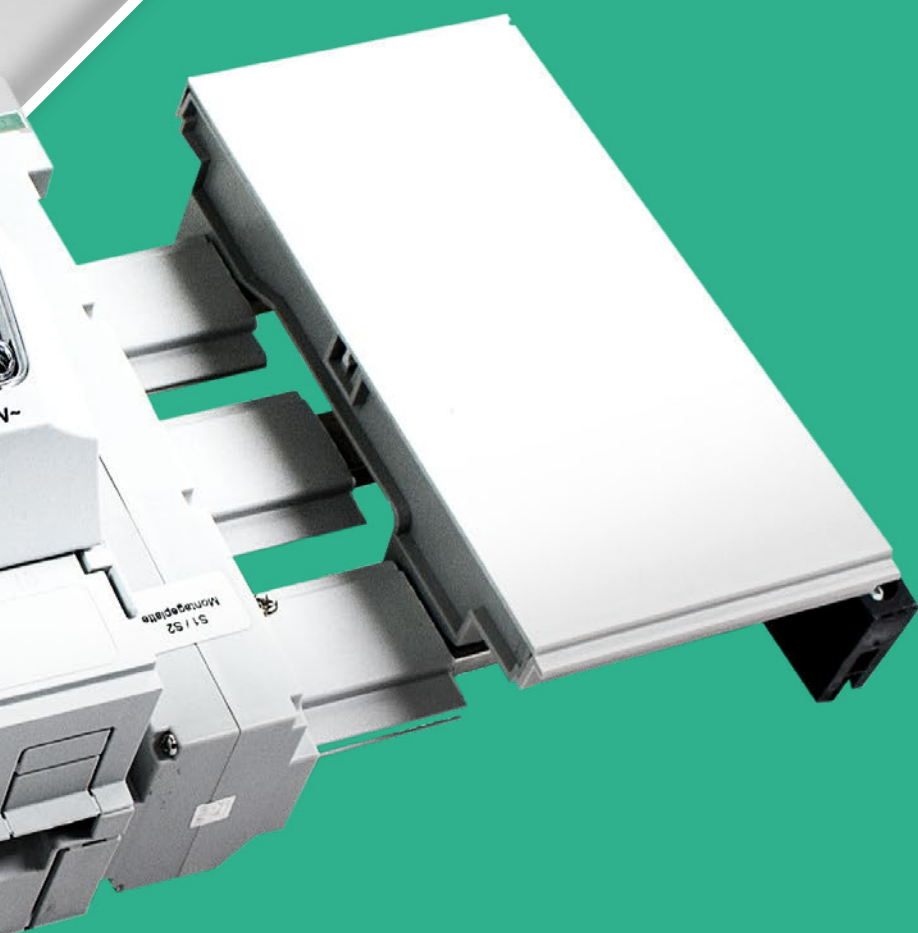

The most widely used busbar system is based on a busbar spacing of 60mm. The success of this system is primarily due to its quick installation. The broad portfolio of components for mounting directly on busbars is another success factor. Our products for the 60mm busbar system offer optimum contacting and a firm hold. Quick and easy installation saves the system builder a great deal of time.

Busbar support

- ✓ Reversible base
- ✓ For busbar system 12-30mm/ 5 and 10mm
- ✓ Fits also for Striebel & John cabinets
- ✓ Mounting inside

Item	Item no.	PU
Busbar level support 3-pole	106300	10
Busbar level support 3-pole, mounting outside	106301	20
Busbar level support 1-pole, pluggable, for busbars 20-30mm/5 und 10mm	106302	10
Busbar level support 1-pole, single mounting, for busbars 20-30mm/5 und 10mm	106304	10

Item	Item no.	PU
Busbar level support end protection 3-pole	106303	10
Busbar level support end protection 1-pole	106310	10
Busbar level support Z end protection 3-pole	106308	10
Combination connector for busbar level support	106307	10

Item	Item no.	PU
Busbar support 2-pole	106004	10
Busbar support 2-pole, PE/N carrier, incl. mounting outside	106005	10

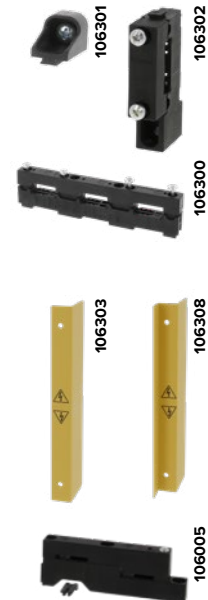

- ✓ Reversible base
- ✓ For busbar system 12-30mm/ 5 and 10mm
- ✓ Fits also for Siemens cabinets
- ✓ Mounting inside

Item	Item no.	PU
Busbar level support, 3-pole, hole distance 75mm	106330	10
Busbar end cap "yellow" for item no. 106000, 106001, 106330	106003	10

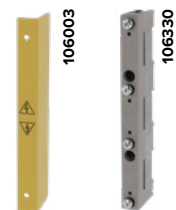

D0 rider fuse base E18

- ✓ Designation field unmistakable – at the base
- ✓ Low loss stainless steel terminal
- ✓ Lateral finger protection
- ✓ Plug-in rear grip protection

Item	Item no.	PU
D0 rider fuse base E18	106022	10
D0 rider fuse base E18 incl. cover 27mm	106023	10
D0 rider fuse base E18 incl. cover 36mm	106028	10
D0 rider fuse base E18 incl. cover 54mm	106029	10

Item	Item no.	PU
Touch protection cover 27mm	106011	10
Touch protection cover 36mm	106012	10
Touch protection cover 54mm	106013	10
Cover left and right 36mm wide	106016	10
Cover left 36mm wide	106017	10
Cover right 36mm wide	106018	10

Item	Item no.	PU
Touch protection as rear grip protection	106026	10

Accessories

Item	Item no.	PU
Screw cap D02 plastic with test hole	126024	20
Screw cap D01 plastic with test hole	126025	20
Screw cap D02 porcelain with test hole	127024	20
Screw cap D01 porcelain with test hole	127025	20
Reducing holder spring for D01 fuses	121401	20

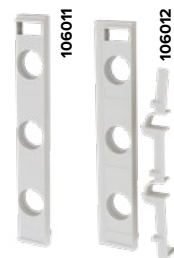
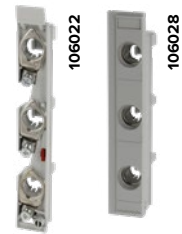

Power supply | Bow terminals

Connection terminals – Protective covers with warning triangle

- ✓ Incl. conductor/rail protection plate
- ✓ For busbar system 12-30mm/ 5 and 10mm

Grey

Item	Item no.	PU
Terminal cover grey incl. rail protection, 54x44mm, for terminals 16...50mm ²	106096	2
Terminal cover grey incl. rail protection, 108x44mm, for terminals 16...70mm ²	106097	1
Terminal cover grey incl. rail protection, 108x80mm, for terminals 16...185mm ²	106098	1

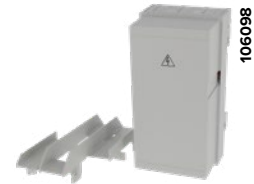

Yellow

Item	Item no.	PU
Terminal cover yellow incl. rail protection, 54x44mm, for terminals 16...50mm ²	106090	2
Terminal cover yellow incl. rail protection, 108x44mm, for terminals 16...70mm ²	106091	1
Terminal cover yellow incl. rail protection, 108x80mm, for terminals 16...185mm ²	106092	1



Busbars – Protective covers, grey (without rail protection plate)

Item	Item no.	PU
Terminal cover grey, 54x44mm	106033	2
Terminal cover grey, 108x44mm	106034	1
Terminal cover grey, 108x80mm	106035	1



Accessories

Bow terminals for copper conductors

Item	Item no.	PU
1.5...16mm ² , for busbars 5mm	116051	100
4.0...35mm ² , for busbars 5mm ²	116052	50
10...50mm ² , for busbars 5mm	116053	50
16...70mm ² , for busbars 5mm	116054	10
16...120mm ² , for busbars 5mm	116055	10
50...185mm ² , for busbars 5mm	116056	10



Item	Item no.	PU
1.5...16mm ² , for busbars 10mm	116061	100
4.0...35mm ² , for busbars 10mm	116062	50
10...50mm ² , for busbars 10mm	116063	50
16...70mm ² , for busbars 10mm	116064	10
16...120mm ² , for busbars 10mm	116065	10
50...185mm ² , for busbars 10mm	116066	10



Bow terminals with fixed pressure plate for copper/ aluminium conductors*

Item	Item no.	PU
1.5...16mm ² , for busbars 5mm	116070	50
4.0...35mm ² , for busbars 5mm	116071	50
16...70mm ² , for busbars 5mm	116072	10
16...120mm ² , for busbars 5mm	116073	10
50...185mm ² , for busbars 5mm	116074	10



Item	Item no.	PU
1.5...16mm ² , for busbars 10mm	116080	50
4.0...35mm ² , for busbars 10mm	116081	50
16...70mm ² , for busbars 10mm	116082	10
16...120mm ² , for busbars 10mm	116083	10
50...185mm ² , for busbars 10mm	116084	10



* Aluminium conductor applications only possible when used with tinned copper bars!

Bow terminals for direct connection of aluminum conductors

Item	Item no.	PU
1.5...16mm ² , for busbars 5mm	116089	20
4.0...35mm ² , for busbars 5mm	116090	20
16...70mm ² , for busbars 5mm	116091	10
16...120mm ² , for busbars 5mm	116092	10
50...185mm ² , for busbars 5mm	116093	10



Item	Item no.	PU
1.5...16mm ² , for busbars 10mm	116094	20
4.0...35mm ² , for busbars 10mm	116095	20
16...70mm ² , for busbars 10mm	116096	10
16...120mm ² , for busbars 10mm	116097	10
50...185mm ² , for busbars 10mm	116098	10



CORON® R

D0 fuse switch disconnecter

- ✓ Flashing indicator
- ✓ Fuse plug
- ✓ Lockable
- ✓ Compact and low design
- ✓ Optional widening
- ✓ Construction width 27mm

400V~, D0: 2 – 63A

Item	Item no.	PU
CORON R D0 fuse switch disconnecter 3-pole	106901	4
CORON R D0 rider fuse switch disconnecter 3-pole incl. fuse 20A and fixed fitting rings	106920	4
CORON R D0 rider fuse switch disconnecter 3-pole incl. fuse 25A and fixed fitting rings	106925	4
CORON R D0 rider fuse switch disconnecter 3-pole incl. fuse 35A and fixed fitting rings	106935	4
CORON R D0 rider fuse switch disconnecter 3-pole incl. fuse 50A and fixed fitting rings	106950	4
CORON R D0 rider fuse switch disconnecter 3-pole incl. fuse 63A and fixed fitting rings	106963	4



Accessories

Item	Item no.	PU
Attachable widening set for CORON R	106971	1
TYTAN R / CORON R / TYTAN T / CORON DUO plug reducing spring from D01 to D02	101774	12
Padlock in the click box	104664	1
CORON R – flashing plug with dummy 400 V~ 63A	106981	1



Locking device



Widening

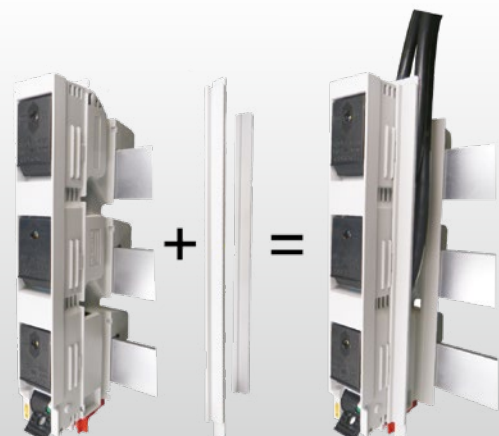

TYTAN® R

D0 rider fuse switch disconnecter with fuse

- ✓ Flashing indicator
- ✓ All-pole switching
- ✓ Fuse plus
- ✓ Construction width 27mm
- ✓ Optional widening
- ✓ Lockable
- ✓ For 5-10mm thick and 12-30mm wide busbars

400V~, D0: 2 – 63A; 10x38: 2 – 32A 400V~

Item	Item no.	PU
TYTAN R rider fuse switch disconnecter 3-pole, AC23B	106601	3
TYTAN R rider fuse switch disconnecter 3-pole + N	106602	3
TYTAN R rider fuse switch disconnecter 3-pole with auxiliary switch for the switching position	106603	3
TYTAN R rider fuse switch disconnecter 3-pole + N with auxiliary switch	106604	3
TYTAN R rider fuse switch disconnecter 3-pole, AC22B	106611	3



Item	Item no.	PU
TYTAN R rider fuse switch disconnecter 3-pole, incl. fuse 20A and fixed fitting rings	106601.24ABF20	3
TYTAN R rider fuse switch disconnecter 3-pole, incl. fuse 25A and fixed fitting rings	106601.24ABF25	3
TYTAN R rider fuse switch disconnecter 3-pole, incl. fuse 35A and fixed fitting rings	106601.24ABF35	3
TYTAN R rider fuse switch disconnecter 3-pole, incl. fuse 50A and fixed fitting rings	106601.24ABF50	3

500V~, 10x38: 2 – 25A

Item	Item no.	PU
TYTAN R rider fuse switch disconnecter 3-pole, 500V AC, 10x38, 2-25A	106631	3
TYTAN R rider fuse switch disconnecter 3-pole + N, 500V AC, 10x38, 2-25A	106632	3
TYTAN R rider fuse switch disconnecter 3-pole + HS, 500V AC, 10x38, 2-25A	106633	3
TYTAN R rider fuse switch disconnecter 3-pole + N + HS, 500V AC, 10x38, 2-25A	106634	3



Accessories

Item	Item no.	PU
TYTAN R - rear grip protection	106626	10
TYTAN R / CORON R / TYTAN T / CORON DUO plug reducing spring from D01 to D02	101774	12
TYTAN T, TYTAN R and IN-ON shorting bolt	101780	3
Padlock in the click box	104664	1
TYTAN R - flashing plug with dummy 400 V ~ 63 A	106620/1	1
Widening/cable duct for TYTAN R, width 13.5mm, height 63mm	106613	5
Widening/cable duct for TYTAN R, width 13.5mm, height 32mm	106610	10



Busbar system 60mm

TYTAN® RH4 main protection

with signaling contact for fuse failure and overtemperature

TYTAN® main protection signals fuse cut-outs and forwards them to the outside via a potential-free changeover contact. At the same time, dangerous overheating of the switching device is also indicated and signaled. **No external voltage** needs to be supplied to the TYTAN® RH4.

- ✓ Flashing indicator
- ✓ Self-supplied
- ✓ Fuse plug
- ✓ Construction width 36mm
- ✓ Lockable
- ✓ Signals via potential-free changeover contact

400V[~], D0: 2 ... 63A; 10 x 38: 2 ... 32A

Item	Item no.	PU
TYTAN RH4 D0 fuse switch disconnecter 3-pole leading/trailing, with fuse monitoring	106711	2
TYTAN RH4 D0 fuse switch disconnecter 3-pole + N, with fuse monitoring	106712	2
TYTAN RH4 D0 fuse switch disconnecter 3-pole, with fuse monitoring + switch position	106713	2
TYTAN RH4 D0 fuse switch disconnecter 3-pole + N, leading/trailing, with electronic fuse monitoring + switch position	106714	2

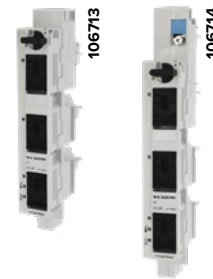

TYTAN® RH1 main protection

with temperature and fuse monitoring system

TYTAN® main protection signals fuse cut-outs and forwards them to the external relay unit via an RJ connection cable. At the same time, dangerous overheating of the switching device is also indicated and reported. A potential-free changeover contact is available as an interface on the relay unit. As a collective fault signal, up to 12 switching devices can be monitored together by connecting them in series.

- ✓ Fuse and temperature monitoring
- ✓ Potential-free relay contacts

400V[~], D0: 2 – 63A; 10 x 38: 2 – 32A

Item	Item no.	PU
TYTAN RH1 D0 fuse switch disconnecter 3-pole, with fuse monitoring	106701	2
TYTAN RH1 D0 fuse switch disconnecter 3-pole + N leading/trailing, with fuse monitoring	106702	2

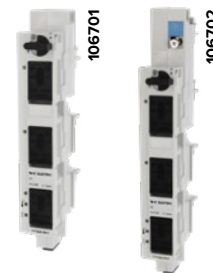

Accessories

Item	Item no.	PU
Main protection relay module HR11, 3 changer	103711	1
Main protection relay module HR12, 2 changer	103712	1
Main protection relay module HR13, 1 changer	103713	1
RJ connection cable 200mm	103730	1
RJ connection cable 500mm	103731	1
RJ connection cable 1000mm	103732	1
RJ connection cable 1500mm	103733	1



TYTAN® RHBUS



Fuse and temperature monitoring with Modbus interface

TYTAN® RHBUS reports fuse cut-outs, excess temperatures and the switching positions of the switching devices connected via RJ connection cables. This means that up to 28 devices can be monitored together. The connector supplies power to the bus and connects to the Modbus RTU interface.

- ✓ Detailed fuse monitoring for up to 28 devices via Modbus RTU interface
- ✓ Checking the individual temperatures and switching positions

Item	Item no.	PU
TYTAN RHBUS DO fuse switch disconnecter 3-pole, with fuse monitoring	101801	2
TYTAN RHBUS DO fuse switch disconnecter 3-pole + N leading/trailing, with fuse monitoring	101802	2



Accessories

Item	Item no.	PU
Terminating resistor RJ11	101839	1
Modbus connector	101830	1
RJ connection cable 200mm	103730	1
RJ connection cable 500mm	103731	1
RJ connection cable 1000mm	103732	1
RJ connection cable 1500mm	103733	1



Item	Item no.	PU
Power supply unit 100-230VAC / 24V DC / 10VA	103700	1



Busbar system
60mm

Busbar adapter

- ✓ Mounting rail adjustable in mm
- ✓ Low-loss double contacting
- ✓ Attachable widening

Other versions available on request:

- ✓ Different cable lengths
- ✓ Desired phases led out, e.g. only L1 executed etc.



Empty adapter 45mm

Item	Item no.	PU
Busbar adapter 45mm; without connections, 207mm	106515	2
Busbar adapter 45mm; without connections, 1MR, 207mm	106516	2
Busbar adapter 72mm; without connections, 1MR, 207mm	106517	2
Busbar adapter 45mm; without connections, 2MR, 260mm	106518	2
Busbar adapter 54mm; without connections, 2MR, 260mm	106519	2



16A | 2,5mm² | AWG 14

Item	Item no.	PU
Busbar adapter 45mm; 16A; 2,5mm ² 1MR, 207mm	106520	2
Busbar adapter 45mm; 16A; 2,5mm ² 1MR, 207mm	106520.165	2

*Item no.165 = Cable length 165mm



25A | 4mm² | AWG 12

Item	Item no.	PU
Busbar adapter 45mm; 25A; 4mm ² 1MR, 207mm	106521	2
Busbar adapter 45mm; 25A; 4mm ² 1MR, 207mm	106521.165	2
Busbar adapter 45mm; 25A; 4mm ² 2MR, 207mm	106522	2
Busbar adapter 45mm; 25A; 4mm ² 2MR, 207mm	106522.165	2
Busbar adapter 45mm; 25A; 4mm ² 2MR, 260mm	106523	2
Busbar adapter 45mm; 25A; 4mm ² 2MR, 260mm	106523.165	2
Busbar adapter 90mm; 25A; 4mm ² 2MR, 207mm	106524	2
Busbar adapter 90mm; 25A; 4mm ² 2MR, 207mm	106524.165	2
Busbar adapter 54mm; 25A; 4mm ² 2MR, 207mm	106562	2
Busbar adapter 54mm; 25A; 4mm ² 2MR, 207mm	106563	2
Busbar adapter 63mm; 25A; 4mm ² 2MR, 207mm	106564	2

*Item no.165 = Cable length 165mm



32A | 6mm² | AWG 10

Item	Item no.	PU
Busbar adapter 45mm; 32A; 6mm ² 1MR, 207mm	106525	2
Busbar adapter 45mm; 32A; 6mm ² 1MR, 207mm	106525.165	2
Busbar adapter 54mm; 32A; 6mm ² 1MR, 207mm	106526	2
Busbar adapter 54mm; 32A; 6mm ² 1MR, 207mm	106526.165	2
Busbar adapter 54mm; 32A; 6mm ² 2MR, 207mm	106527	2
Busbar adapter 54mm; 32A; 6mm ² 2MR, 207mm	106527.165	2
Busbar adapter 54mm; 32A; 6mm ² 2MR, 260mm	106528	2
Busbar adapter 54mm; 32A; 6mm ² 2MR, 207mm	106528.165	2
Busbar adapter 63mm; 32A; 6mm ² 1MR, 207mm	106529	2
Busbar adapter 63mm; 32A; 6mm ² 1MR, 207mm	106529.165	2
Busbar adapter 72mm; 32A; 6mm ² 1MR, 207mm	106530	2
Busbar adapter 72mm; 32A; 6mm ² 1MR, 207mm	106530.165	2
Busbar adapter 72mm; 32A; 6mm ² 2MR, 260mm	106531	2
Busbar adapter 72mm; 32A; 6mm ² 2MR, 260mm	106531.165	2
Busbar adapter 81mm; 32A; 6mm ² 2MR, 207mm	106532	2
Busbar adapter 81mm; 32A; 6mm ² 2MR, 207mm	106532.165	2
Busbar adapter 45mm; 32A; 6mm ² 2MR, 207mm	106565	2
Busbar adapter 45mm; 32A; 6mm ² 2MR, 260mm	106566	2
Busbar adapter 45mm; 32A; 6mm ² 2MR, 260mm	106566.165	2

*Item no.165 = Cable length 165mm



63A | 10mm² | AWG 8

Item	Item no.	PU
Busbar adapter 54mm; 63A; 10mm ² 1MR, 207mm	106533	2
Busbar adapter 54mm; 63A; 10mm ² 1MR, 207mm	106533.165	2
Busbar adapter 54mm; 63A; 10mm ² 2MR, 207mm	106534	2
Busbar adapter 54mm; 63A; 10mm ² 2MR, 207mm	106534.165	2
Busbar adapter 54mm; 63A; 10mm ² 2MR, 260mm	106535	2
Busbar adapter 54mm; 63A; 10mm ² 2MR, 260mm	106535.165	2
Busbar adapter 63mm; 63A; 10mm ² 1MR, 207mm	106536	2
Busbar adapter 63mm; 63A; 10mm ² 1MR, 207mm	106536.165	2
Busbar adapter 72mm; 63A; 10mm ² 1MR, 207mm	106537	2
Busbar adapter 72mm; 63A; 10mm ² 1MR, 207mm	106537.165	2
Busbar adapter 72mm; 63A; 10mm ² 2MR, 260mm	106538	2
Busbar adapter 72mm; 63A; 10mm ² 2MR, 260mm	106538.165	2
Busbar adapter 81mm; 63A; 10mm ² 2MR, 207mm	106539	2
Busbar adapter 81mm; 63A; 10mm ² 2MR, 207mm	106539.165	2

*Item no.165 = Cable length 165mm



80A | 16mm² | AWG 6

Item	Item no.	PU
Busbar adapter 72mm; 80A; 16mm ² 1MR, 207mm	106543	2
Busbar adapter 72mm; 80A; 16mm ² 1MR, 207mm	106543.165	2
Busbar adapter 72mm; 80A; 16mm ² 2MR, 260mm	106544	2
Busbar adapter 72mm; 80A; 16mm ² 2MR, 260mm	106544.165	2

*Item no.165 = Cable length 165mm



Busbar system
60mm

Accessories

Item	Item no.	PU
Busbar adapter – PIN rail	106560	1
Busbar adapter – Side panel 9mm attachable	106561	1
Busbar adapter – Mounting rail 45mm	106551	1
Busbar adapter – Mounting rail 54mm	106552	1
Busbar adapter – Mounting rail 63mm	106553	1
Busbar adapter – Mounting rail 72mm	106554	1
Busbar adapter – Mounting rail 81mm	106555	1
Busbar adapter – Mounting rail 90mm	106556	1

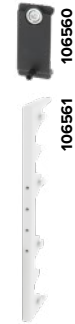

TYTAN® Busbar adapter

with TYTAN® DO switch disconnecter ready for connection to 60 mm busbars
adapter incl. infeed with touch protection

TYTAN I Busbar adapter construction width 54mm

Item	Structure	100mm Item no.	125mm Item no.	150mm Item no.	PU
TYTAN I Busbar adapter 54mm MONO	1x3-pole	106201	106201	–	1
TYTAN I Busbar adapter 54mm DUO	2x3-pole	106202	106206	–	1
TYTAN I Busbar adapter 54mm MONO	3x1-pole	106203	106203	–	1
TYTAN I Busbar adapter 54mm DUO	6x1-pole	106204	106207	–	1
TYTAN I Busbar adapter 54mm DUO	3x1-pole + 1x3-pole	106205	106208	–	1



TYTAN II Busbar adapter construction width 81mm

Item	Structure	100mm Item no.	125mm Item no.	150mm Item no.	PU
TYTAN II Busbar adapter 81mm MONO	1x3-pole	106221	106221	106234	1
TYTAN II Busbar adapter 81mm DUO	2x3-pole	106222	106226	106229	1
TYTAN II Busbar adapter 81mm MONO	3x1-pole	106223	106223	106235	1
TYTAN II Busbar adapter 81mm DUO	6x1-pole	106224	106227	106230	1
TYTAN II Busbar adapter 81mm DUO	3x1-pole + 1x3-pole	106225	106228	106231	1



TYTAN II Busbar adapter construction width 54mm

Item	Structure	100mm Item no.	125mm Item no.	150mm Item no.	PU
TYTAN II Busbar adapter 54 mm DUO	2x2-pole	106237	106232	–	1
TYTAN II Busbar adapter 54 mm DUO	4x1-pole	106238	106233	–	1
TYTAN II Busbar adapter 54 mm MONO	1x2-pole	106239	106239	–	1
TYTAN II Busbar adapter 54 mm MONO	2x1-pole	106240	106240	–	1



TYTAN® II main protection on busbar adapter

Item	Structure	Center distance	Item no.	PU
TYTAN II main protection busbar adapter MONO	1x3-pole	125mm	106275	1
TYTAN II main protection busbar adapter DUO	2x3-pole	125mm	106276	1
TYTAN II main protection busbar adapter MONO	1x3-pole	150mm	106277	1
TYTAN II main protection busbar adapter DUO	2x3-pole	150mm	106278	1
TYTAN II main protection busbar adapter MONO	1x2-pole	125mm	106285	1
TYTAN II main protection busbar adapter DUO	2x2-pole	125mm	106289	1



Three-phase compact current transformer

- ✓ Hole center distance 60mm
- ✓ For rail thicknesses from 12x5 – 30x10mm
- ✓ Construction width 48.5mm
- ✓ Spring terminals 4mm²
- ✓ All-round touch protection of the busbars
- ✓ Can be used flexibly in the installation distributor and on a mounting plate

Item	Item no.	PU
Three-phase current transformer, primary current 100A, 60mm busbar, Class 1; 1VA	223013-100/5A	1
Three-phase current transformer, primary current 150A, 60mm busbar, Class 1; 1,5VA	223013-150/5A	1
Three-phase current transformer, primary current 200A, 60mm busbar, Class 1; 2,5VA	223013-200/5A	1
Three-phase current transformer, primary current 250A, 60mm busbar, Class 1; 2,5VA	223013-250/5A	1
Three-phase current transformer, primary current 400A, 60mm busbar, Class 1; 3,75VA	223013-400/5A	1
Three-phase current transformer, primary current 600A, 60mm busbar, Class 1; 5VA	223013-600/5A	1
Three-phase current transformer, primary current 630A, 60mm busbar, Class 1; 5VA	223013-630/5A	1



NH00 fuse switch disconnecter VSD

for mounting on busbar systems 60mm

- ✓ Symmetrical safety edge: Cable outlet top/bottom selectable during installation
- ✓ Touch protection IP30 with central cover
- ✓ Park position of the switch cover, even with NH fuse inserts fitted

NH 00 VSD/60mm, 3-pole, 160A/690V

Item	Item no.	PU
NH 00 fuse switch disconnecter VSD00-60mm, 160A, 3-pole, cable outlet top/bottom, clamp/screw	208050	1
NH 00 fuse switch disconnecter VSD00-60mm, 160A, 3-pole, cable outlet top/bottom, frame terminal	208052	1
NH 00 fuse switch disconnecter VSD00-60mm, 160A, 3-pole, with EFM	208054	1



NH fuse switch disconnecter for panel mounting series KE

- ✓ Integrated window lock
- ✓ Drillless mounting on 60 mm busbar systems
- ✓ For 12 – 30mm width und 5 – 10mm strength
- ✓ Integrated touch protection
- ✓ Sealable
- ✓ Fuse monitoring optional
- ✓ NH 000 RT nur 54mm wide

NH 000 RT, 3-pole, 125A/690V series KE

Item	Item no.	PU
NH 000 RT 125A, 3-pole, cable outlet bottom, 54mm wide, frame terminal 2.5-50mm ²	209010	1
NH 000 RT 125A, 3-pole, cable outlet top, 54mm wide, frame terminal 2.5-50mm ²	209011	1



Accessories NH 000

Item	Item no.	PU
Indicator switch set for switching position NH 000 KE	200852/000	1

NH 00 RT, 3-pole, 160A/690V series KE

Item	Item no.	PU
NH 00 RT 160A, 3-pole, cable outlet bottom, 108mm wide, frame terminal 2.5-95mm ²	208010	1
NH 00 RT 160A, 3-pole, cable outlet top, 108mm wide, frame terminal 2.5-95mm ²	208011	1
NH 00 RT 160A, 3-pole, cable outlet bottom, 108mm wide, connection screw M8	208012	1
NH 00 RT 160A, 3-pole, cable outlet top, 108mm wide, connection screw M8	208013	1



NH 00 incl. electronic fuse monitoring (EFM)

Item	Item no.	PU
NH 00 RT 160A, 3-pole, cable outlet bottom, 108mm wide, frame terminal 2.5-95mm ² , EFM	208070	1
NH 00 RT 160A, 3-pole, cable outlet top, 108mm wide, frame terminal 2.5-95mm ² , EFM	208071	1
NH 00 RT 160A, 3-pole, cable outlet bottom, 108mm wide, frame terminal 2.5-95mm ² , with EFM and RJ interface	208076	1
NH 00 RT 160A, 3-pole, cable outlet top, 108mm wide, frame terminal 2.5-95mm ² , with EFM and RJ interface	208077	1



208070

Accessories NH 00

Item	Item no.	PU
Terminal cover size 00	200148	1
Indicator switch for switching position NH 00 KE	200852	1
NH 00 terminals AL/Cu 1.5-70 mm ² (1 set = 3 pieces) series KE	208053	1



200148



200852

NH 1 RT, 3-polig, 250A/690V series KE

Item	Item no.	PU
NH 1 RT 250A, 3-pole, cable outlet bottom, 180mm wide, connection screw M10	208110	1
NH 1 RT 250A, 3-pole, cable outlet top, 180mm wide, connection screw M10	208111	1
NH 1 RT 250A, 3-pole, cable outlet bottom, 180mm wide, V terminals	208112	1



208110

NH 1 incl. electronic fuse monitoring (EFM)

Item	Item no.	PU
NH 1 RT 250A, 3-pole, cable outlet bottom, 180mm wide, connection screw M10, EFM	208170	1
NH 1 RT 250A, 3-pole, cable outlet top, 180mm wide, connection screw M10, EFM	208171	1
NH 1 RT 250A, 3-pole, cable outlet bottom, 180mm wide, connection screw M10, with EFM and RJ interface	208176	1
NH 1 RT 250A, 3-pole, cable outlet top, 180mm wide, connection screw M10, with EFM and RJ interface	208177	1

NH 1 for the 100mm busbar system

Item	Item no.	PU
NH 1 RT 250A, 3-pole, cable outlet bottom, 180mm wide, connection screw M10	208120	1

Accessories NH 1

Item	Item no.	PU
Terminal cover size 1	201148	1
Indicator switch for switching position NH 1/2/3 series KE	201852	1
Prism terminal NH 1, 70-150mm ² (1 set = 3 pieces)	200420	1



201148



201852

NH 2 RT, 3-pole, 400A/690V series KE

Item	Item no.	PU
NH 2 RT 400A, 3-pole, cable outlet bottom, 208mm wide, connection screw M10	208210	1
NH 2 RT 400A, 3-pole, cable outlet top, 208mm wide, connection screw M10	208211	1
NH 2 RT 400A, 3-pole, cable outlet bottom, 208mm wide, V terminals	208212	1



NH 2 incl. electronic fuse monitoring (EFM)

Item	Item no.	PU
NH 2 RT 400A, 3-pole, EFM, cable outlet bottom	208270	1
NH 2 RT 400A, 3-pole, EFM, cable outlet top	208271	1
NH 2 RT 400A, 3-pole, mit EFM und RJ fuse monitoring, cable outlet bottom	208276	1
NH 2 RT 400A, 3-pole, mit EFM und RJ fuse monitoring, cable outlet top	208277	1

NH 2 for the 100mm busbar system

Item	Item no.	PU
NH 2 rider fuse switch disconnecter 400A, 100mm system, 3-pole, cable outlet bottom	208220	1

Accessories NH 2

Item	Item no.	PU
Terminal cover size 2	202148	1
Indicator switch for switching position NH 1/2/3 series KE	201852	1
Prism terminal NH 2, 120-240mm ² AL/CU (1 set = 3 pieces)	201237	1



NH 3 RT, 3-pole, 630A/690V series KE

Item	Item no.	PU
NH 3 RT 630A, 3-pole, cable outlet bottom, 250mm wide, connection screw M12	208310	1
NH 3 RT 630A, 3-pole, cable outlet top, 250mm wide, connection screw M12	208311	1



NH 3 incl. electronic fuse monitoring (EFM)

Item	Item no.	PU
NH 3 RT 630A, 3-pole, KE cable outlet bottom, EFM	208370	1

Accessories NH 3

Item	Item no.	PU
Terminal cover size 3	203148	1
Indicator switch for switching position NH1/2/3 series KE	201852	1



NH fuse switch disconnector for panel mounting MULTIBLOC®

- ✓ Drillless mounting
- ✓ For busbar with 12 – 30mm width and 5 – 10mm strength
- ✓ Fuse monitoring optional
- ✓ Integrated touch protection
- ✓ Sealable
- ✓ NH 00 | NH 1 lockable
- ✓ Top/bottom outlet selectable (not with NH 000)

MULTIBLOC® NH 000 RT, 3-pole, 100A/690V, 54mm construction width

Item	Item no.	PU
NH 000 RT 100A, 3-pole, cable outlet bottom, 54mm wide, frame terminal 2.5-50mm ²	149010	1
NH 000 RT 100A, 3-pole, cable outlet top, 54mm wide, frame terminal 2.5-50mm ²	149011	1



NH 000 incl. electronic fuse monitoring (EFM)

Item	Item no.	PU
NH 000 RT Multibloc 100A, EFM, cable outlet bottom, 54mm wide	149070	1
NH 000 RT Multibloc 100A, EFM, cable outlet top, 54mm wide	149071	1

Accessories NH 000

Item	Item no.	PU
Indicator switch for switching position	140643	1
Cable cover NH 000 RT (1 set = 2 pieces)	140644	1



MULTIBLOC® NH 00 RT, 3-pole, 160A/690V

Item	Item no.	PU
NH 00 RT 160A, 3-pole, cable outlet top/bottom, 108mm wide, connection screw M8, clip terminal clamps 4-70mm ²	148010	1
NH 00 RT 160A, 3-pole, cable outlet top/bottom, 108mm wide, frame terminal 2.5-70mm ²	148012	1



NH 00 incl. electronic fuse monitoring (EFM)

Item	Item no.	PU
NH 00 RT Multibloc 160A, 3-pole, 3 connection screw M8, EFM	148070	1



Accessories NH 00

Item	Item no.	PU
Terminals AL/Cu 1.5-70 mm ² (1 set = 3 pieces)	148053	1
Indicator switch for switching position	140852	1
Handle protection as rear grip protection	140147	1
Cover panel 1-fold NH 00 3-pole, 123 x 190mm	140126	1
Cover panel 2-fold NH 00 3-pole, 231 x 190mm	140127	1
Cover panel 3-fold NH 00 3-pole, 339 x 190mm	140128	1

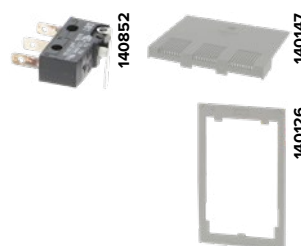

Accessories NH 00

Item	Item no.	PU
Cover panel 1-fold NH 00 3-pole, 123 x 210mm	143431	1
Cover panel 1-fold NH 00 3-pole with 1-fold Empty field cover, 231 x 210mm	142870	1
Cover panel 2-fold NH 00 3-pole, 231 x 210mm	142874	1
Sealing set	140155	1
Cable cover for NH-00 fuse switch disconnecter 3-pole (1 set = 2 pieces)	140148	1

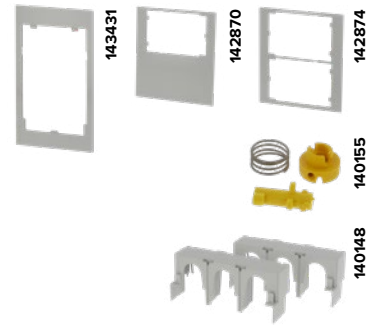

MULTIBLOC® NH 1 RT, 3-pole, 250A/690V

Item	Item no.	PU
NH 1 RT 250A, 3-pole, cable outlet top/bottom, 185mm wide, connection screws M10	148110	1



NH 1 incl. electronic fuse monitoring (EFM)

Item	Item no.	PU
NH 1 RT Multibloc 250A, EFM, 3-pole, 3 connection screws M10	148170	1



Accessories NH 1

Item	Item no.	PU
Clip terminal clamps 70-150 mm ² (1 set = 2 pieces)	140420	1
Indicator switch for switching position	140852	1
Handle protection as rear grip protection (1 set = 2 pieces), NH 1	140355	1
Cable cover NH 1 (1 set = 2 pieces)	140382	1
Cover panel 1-fold NH 1 3-pole, 210 x 260mm	140353	1
Cover panel 1-fold NH 1 3-pole, 230 x 283mm	142351	1
Sealing set	140155	1

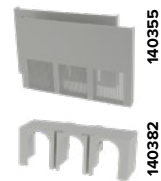

MULTIBLOC® NH 2 RT, 3-pole, 400A/690V

Item	Item no.	PU
NH 2 RT Multibloc 400A, 3-pole, 3 connection screws M10	148210	1



NH 2 incl. electronic fuse monitoring (EFM)

Item	Item no.	PU
NH 2 RT Multibloc 400A, EFM, 3-pole, 3 connection screws M10	148270	1



Accessories NH 2

Item	Item no.	PU
Clip terminal clamps 120-240 mm ²	141237	1
Indicator switch for switching position	140852	1
Handle protection as rear grip protection (1 set = 2 pieces)	140862	1
Cable cover NH 2 (1 set = 2 pieces)	140861	1
Cover panel 1-fold NH 2 3-pole, 230 x 300mm	140863	1
Cover panel 1-fold NH 2 3-pole, 234 x 310mm	142352	1



Cover system

Several cover systems of touch protection for the 60mm system

U-shaped cover profile

Item	Item no.	PU
1 Panel mount; support edge 32mm	126074	10
2 Panel cover 1000mm long (U-shape)	136075	2
Panel mount; support edge 32mm	126075	2



PANCERO rail protection

- ✓ Click closure – can only be opened with tools
- ✓ High temperature resistant plastic PA66
- ✓ Length 1000mm
- ✓ For busbars width 12, 15, 20, 25, 30mm
- ✓ Can be cut to length individually

Item	Item no.	PU
PANCERO busbar cover for 5mm Cu rail, 1.0m	106335	16
PANCERO busbar cover for 10mm Cu rail, 1.0m	106340	10





Series VSD
Fuse switch strip



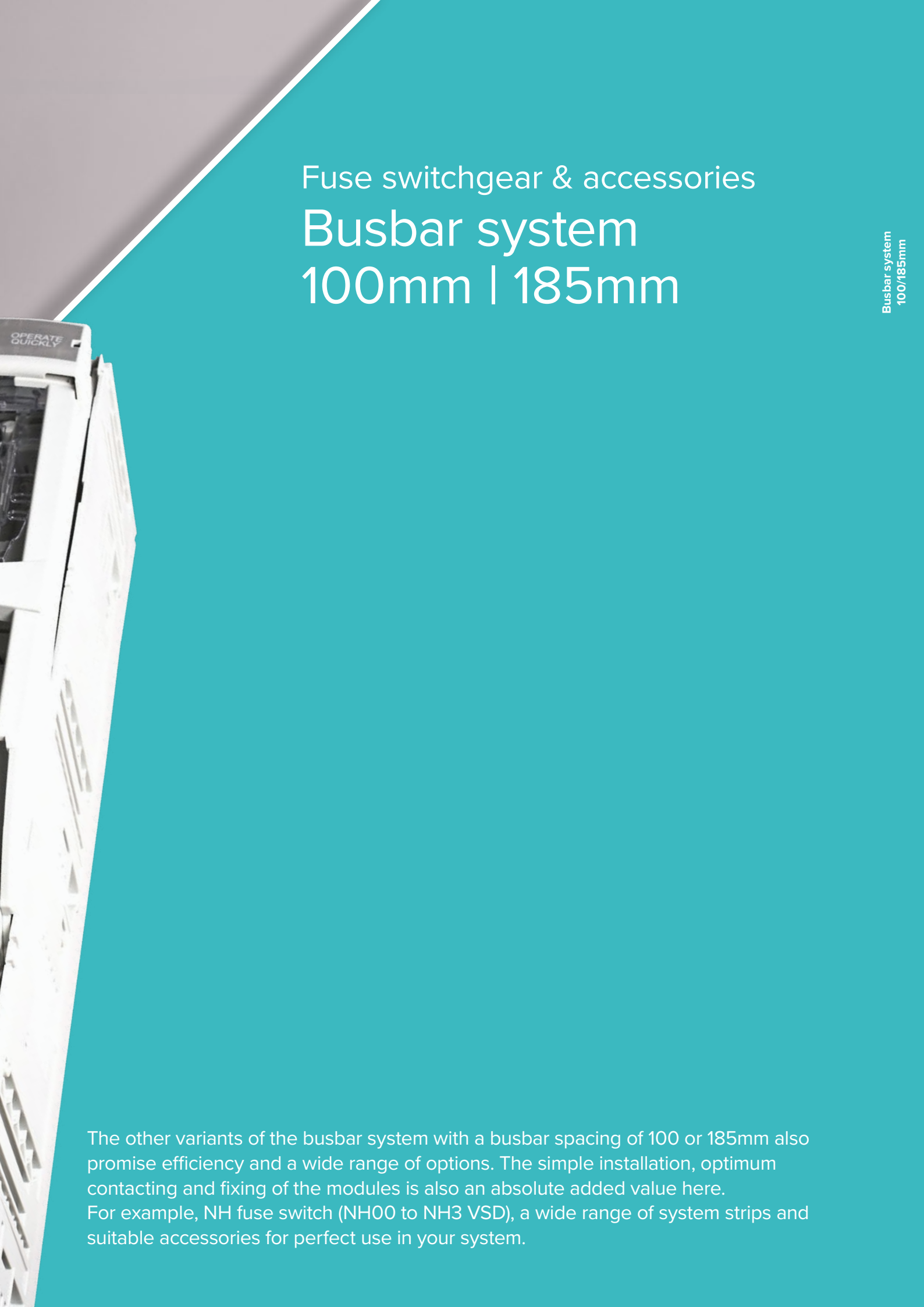

Fuse switchgear & accessories

Busbar system

100mm | 185mm

Busbar system
100/185mm

The other variants of the busbar system with a busbar spacing of 100 or 185mm also promise efficiency and a wide range of options. The simple installation, optimum contacting and fixing of the modules is also an absolute added value here. For example, NH fuse switch (NH00 to NH3 VSD), a wide range of system strips and suitable accessories for perfect use in your system.

Busbar support

for the 100mm and 185mm system

- ✓ Drillless mounting of busbars
- ✓ Busbar width from 30–120mm (185mm system)
- ✓ Busbar width from 30–60mm (100mm system)
- ✓ Busbar thickness: 5–10mm

For 10mm Cu rails

Item	Item no.	PU
Busbar support 100/10mm system 3-pole, 10mm Cu rails	188100	2
Busbar support 185/10mm system 3-pole, 10mm Cu rails	188101	2
Busbar support 1-pole, 10mm Cu rails	188102	2



For 5mm Cu rails

Item	Item no.	PU
Busbar support 100/5mm system 3-pole, 5mm Cu rails	188105	2
Busbar support 185/5mm system 3-pole, 5mm Cu rails	188107	2



Accessories

Item	Item no.	PU
End cover 3-pole for 100mm busbar support	188103	1
End cover 3-pole for 185mm busbar support	188104	1
Mounting bracket for busbar support 185mm, 3-pole (1 set = 2 pieces)	188110	1



NH strip-type fuse switch disconnecter VSD

for mounting on busbar systems 100mm/185mm

- ✓ Park position of the switch cover, even with NH fuse inserts fitted
- ✓ Optionally with fuse monitoring or integrated transformers (Class 0.5)

NH 00 VSD/100mm, 3-pole, 160A/690V

Item	Item no.	PU
NH 00 VSD, 160A, 3-pole, clip terminal clamps 4-70mm ² / screw M8	208055	1
NH 00 VSD, 160A, 3-pole, V terminal	208056	1
NH 00 VSD, 160A, 3-pole, clip terminal clamps 4-70mm ² / screw M8, with electronic fuse monitoring	208057	1



NH 00 VSD/185mm, 3-pole, 160A/690V

Item	Item no.	PU
NH 00 VSD, 160A, 3-pole, clip terminal clamps 4-70mm ² / screw M8	208080	1
NH 00 VSD, 160A, 3-pole, V terminal	208081	1
NH 00 VSD, 160A, 3-pole, clip terminal clamps 4-70mm ² / screw M8, with electronic fuse monitoring	208085	1
NH 00 VSD, 160A, 3-pole, V terminal, with integrated current transformers 150/5A Class 0.5 and connection block for the measuring leads	208088	1
NH 00 VSD, 160A, 3-pole, clip terminal clamps 4-70mm ² / screw M8, with integrated current transformers 150/5A Class 0.5 and connection block for the measuring leads	208089	1
NH 00 VSD, 160A, 3-pole, clip terminal clamps 4-70mm ² / screw M8, without height compensation to NH 1,2,3. Can be used with double adapter 185/185mm Item no.: 208065	208086	1
NH 00 VSD, 160A, 3-pole, V terminal, without height compensation to NH 1,2,3. Can be used with double adapter 185/185mm Item no.: 208065	208087	1



NH 00 VSD00-PV/185mm, 3-pole, 80A/800V AC

Item	Item no.	PU
NH 00 VSD-PV, 160A, 3-pole, clip terminal clamps 4-70mm ² / screw M8	208080-800	1
NH 00 VSD-PV, 160A, 3-pole, V terminal	208081-800	1

Accessories

Item	Item no.	PU
NH 00 clip terminal clamps Cu 4-70 mm ² (Set = 3 pieces)	208051	1
Terminals AL/Cu 1.5-70 mm ² (1 set = 3 pieces)	148053	1
Compensating cover for VSD00/100 to size 1/2/3	208061	1
Extension / terminal cover (transparent) for VSD NH 00	208062	1
Double adapter for VSD00/185 (Item no.: 208086 + 208087) to 185mm system	208065	1
Single adapter for VSD00/100 to 185mm system	208066	1
Double adapter for VSD00/100 to 185mm system	208067	1



Busbar system 100/185mm

NH 1 VSD/185mm, 3-pole, 250A/690V

Item	Item no.	PU
NH 1 VSD, 250A, 3-pole, connection screw M12	208150	1
NH 1 VSD, 250A, 3-pole, V terminals	208190	1
NH 1 VSD, 250A, 3-pole, connection screw M12, with electronic fuse monitoring	208155	1
NH 1 VSD, 250A, 3-pole, connection screw M12 with integrated converters 250/5A Class 0.5 and connection block for the measuring leads	208159	1

**NH 1 VSD/185mm, 1-pole, 250A/690V**

Item	Item no.	PU
NH 1 VSD, 250A, 1-pole, connection screw M12	208160	1
NH 1 VSD, 250A, 1-pole, V terminals	208161	1
NH 1 VSD, 250A, 1-pole, connection screw M12, with electronic fuse monitoring	208165	1
NH 1 VSD, 250A, 1-pole, connection screw M12, with integrated converters 250/5A Class 0.5 and connection block for the measuring leads	208169	1

**NH 2 VSD/185mm, 3-pole, 400A/690V**

Item	Item no.	PU
NH 2 VSD, 400A, 3-pole, connection screw M12	208250	1
NH 2 VSD, 400A, 3-pole, V terminals	208290	1
NH 2 VSD, 400A, 3-pole, connection screw M12 with electronic fuse monitoring	208255	1
NH 2 VSD, 400A, 3-pole, connection screw M12, with integrated converters 400/5A Class 0.5 and connection block for the measuring leads	208259	1

**NH 2 VSD2-PV, 3-pole, 200A/800V AC**

Item	Item no.	PU
NH2 VSD2-PV, 200A, 3-pole, connection screw M12	208250-800	1
NH2 VSD2-PV, 200A, 3-pole, V terminals	208290-800	1

NH 2 VSD/185mm, 1-pole, 400A/690V

Item	Item no.	PU
NH 2 VSD, 400A, 1-pole, connection screw M12	208260	1
NH 2 VSD, 400A, 1-pole, V terminals	208261	1
NH 2 VSD, 400A, 1-pole, with electronic fuse monitoring	208265	1
NH 2 VSD, 400A, 1-pole, with integrated converters Class 0.5, 400/5A	208269	1



NH 3 VSD/185mm, 3-pole, 630A/690V

Item	Item no.	PU
NH 3 VSD, 630A, 3-pole, connection screw M12	208350	1
NH 3 VSD, 630A, 3-pole, V terminals	208390	1
NH 3 VSD, 630A, 3-pole, with electronic fuse monitoring	208355	1
NH 3 VSD, 630A, 3-pole, with integrated converters Class 0.5, 630/5A	208359	1



NH 3 VSD3-PV, 3-pole, 400A/800V AC

Item	Item no.	PU
NH 3 VSD3-PV, 400A, 3-pole, connection screw M12	208350-800	1
NH 3 VSD3-PV, 400A, 3-pole, V terminals	208390-800	1

NH 3 VSD/185mm, 1-pole, 630A/690V

Item	Item no.	PU
NH 3 VSD, 630A, 1-pole, connection screw M12	208360	1
NH 3 VSD, 630A, 1-pole, V terminals	208361	1
NH 3 VSD, 630A, 1-pole, with electronic fuse monitoring	208365	1
NH 3 VSD, 630A, 1-pole, with integrated converters Class 0.5, 630/5A	208369	1



NH 2/3 VSD/185mm strip-type-switch-disconnector, 1- and 3-pole switchable

Item	Item no.	PU
NH 2 VSD, outlet left, 1-pole, screw M12	208264.L	1
NH 2 VSD, outlet left, 3-pole, screw M12	208254.L	1
NH 2 VSD, outlet right, 1-pole, screw M12	208264.R	1
NH 2 VSD, outlet right, 3-pole, screw M12	208254.R	1
NH 3 VSD, outlet left, 1-pole, screw M12	208364.L	1
NH 3 VSD, outlet left, 3-pole, screw M12	208354.L	1
NH 3 VSD, outlet right, 1-pole, screw M12	208364.R	1
NH 3 VSD, outlet right, 3-pole, screw M12	208354.R	1



NH 2/3 VSD/185mm double strip-type-switch-disconnector, 3-pole switchable, 800A/1250A

Item	Item no.	PU
NH 2 VSD, 3-pole, screw M12	208257	1
NH 3 VSD, 3-pole, screw M12	208357	1



Busbar system
100/185mm

Accessories

Item	Item no.	PU
Claw terminal size 00 (Set) for direct mounting (1 set = 3 pieces)	200191	1
Claw terminal for NH MSL size 1,2,3 (1 set = 3 pieces)	200192	1
Extension cover for VSD NH 1-3	208063	1
Primary tube as spacer (Cu sleeve), M8	200125	1
Primary tube as spacer (Cu sleeve), M12	200126	1



NH strip-type fuse switch disconnecter EVO

for installation in cable distributors

NH 00 VSD00-EVO, 160A/690V

Item	Item no.	PU
NH 00 VSD-EVO, 160A, 3-pole, clip terminal clamps 4-70mm ² , connection screw M8	208080-EVO	1
NH 00 VSD-EVO, 160A, 3-pole, V terminal	208081-EVO	1



NH 2 VSD2-EVO, 400A/690V

Item	Item no.	PU
NH 2 VSD-EVO, 400A, 3-pole, connection screw M12	208250-EVO	1
NH 2 VSD-EVO, 400A, 3-pole, V terminal	208290-EVO	1



Item	Item no.	PU
NH 2 VSD-EVO, 400A, 1-pole, connection screw M12	208260-EVO	1
NH 2 VSD-EVO, 400A, 1-pole, V terminal	208261-EVO	1

NH 3 VSD3-EVO, 630A/690V

Item	Item no.	PU
NH 3 VSD-EVO, 630A, 3-pole, connection screw M12	208350-EVO	1
NH 3 VSD-EVO, 630A, 3-pole, V terminal	208390-EVO	1



Item	Item no.	PU
NH 3 VSD-EVO, 630A, 1-pole, connection screw M12	208360-EVO	1
NH 3 VSD-EVO, 630A, 1-pole, V terminal	208361-EVO	1

NH strip-type fuse switch disconnecter MULTIVERT®

NH 00 MSL, 3-pole, 160A / 690V

Mounting on 100mm

Busbar system, cable connection selectable (top/bottom)

Mounting on 185mm

Busbar system with adapter, cable connection selectable (top/bottom)

Item	Item no.	PU
NH 00 MSL, 160A, 3-pole, clip terminal clamps 4-70mm ² / screw M8	148055	1
NH 00 MSL, 160A, 3-pole, V connection, without clamps	148056	1
Compensation cover for NH 00 MSL (1 set = 2 pieces)	148061	1
Claw terminal for NH 00 MSL direct mounting, (1 set = 3 pieces)	148063	1
V connection terminal, size 00	142908	30

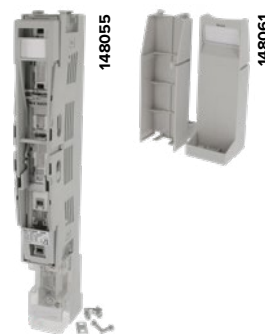

Accessories

Item	Item no.	PU
Single adapter for NH 00 MSL mounting on 185mm system, screw connection	148066	1
Double adapter for NH 00 MSL mounting on 185mm system, screw connection	148067	1
Single adapter for NH 00 MSL drillless 100/185mm, terminal connection	148076	1
Double adapter for NH 00 MSL drillless 100/185mm, terminal connection	148077	1
Single adapter 100/185mm for current transformers	140117	1
Double adapter 100/185mm for current transformers	140119	1



Item	Item no.	PU
Measuring transformer set 1-pole measurement up to 100/5A	140121	1
Measuring transformer set 3-pole measurement up to 100/5A (1 set = 3 pieces)	140122	1
Measuring transformer set 1-pole measurement up to 150/5A	140123	1
Measuring transformer set 3-pole measurement up to 150/5A (1 set = 3 pieces)	140124	1
Primary tube for adapter as spacer (1 set = 3 pieces)	140125	1



Busbar system 100/185mm

NH strip-type fuse switch disconnecter MULTIVERT®

- ✓ Mounting on 185mm busbar systems
- ✓ Cable connection on top/bottom selectable for installation
- ✓ Drillless direct mounting by claw terminals (optional)
- ✓ Different connection variants
- ✓ Optionally with fuse monitoring or integrated transformers
- ✓ 1-pole switchable on request

MULTIVERT® NH 1 MSL 3-pole, 250A/690V

Item	Item no.	PU
NH 1 MSL, 250A, 3-pole, bolt M10	148150	1
NH 1 MSL, 250A, 3-pole, bolt M10, with electronic fuse monitoring	148155	1
NH 1 MSL, 250A, 3-pole, integrated current transformer 250/5A, Class 1	148159	1
NH 1 MSL, 250A, 3-pole, V connection	148190	1



MULTIVERT® NH 2 MSL 3-pole, 400A/690V

Item	Item no.	PU
NH 2 MSL, 400A, 3-pole, bolt M12	148250	1
NH 2 MSL, 400A, 3-pole, bolt M12, with electronic fuse monitoring	148255	1
NH 2 MSL, 400A, 3-pole, integrated current transformer 400/5A, Class 1	148259	1
NH 2 MSL, 400A, 3-pole, V connection	148290	1



MULTIVERT® NH 3 MSL 3-pole, 630A/690V

Item	Item no.	PU
NH 3 MSL, 630A, 3-pole, bolt M12	148350	1
NH 3 MSL, 630A, 3-pole, bolt M12, with electronic fuse monitoring	148355	1
NH 3 MSL, 630A, 3-pole, integrated current transformer 600/5; 3-phase measurement	148359	1
NH 3 MSL, 630A, 3-pole V connection	148390	1



**MULTIVERT® NH double strip-type switch disconnecter
3-pole, 690V AC, 800A size 2, 1260A size 3**

Item	Item no.	PU
Cable cover for double strip-type switch disconnecter, Bottom cable outlet	142394	1
Cable cover for double strip-type switch disconnecter, Top cable outlet	142395	1
NH 2 MSL double strip-type switch disconnecter 800A, 3-pole	148257	1
NH 3 MSL double strip-type switch disconnecter, 1260A, 3-pole	148357	1



142394

MULTIVERT® NH 3 MSL 4-pole (3-pole+N), 630A/690V

Item	Item no.	PU
NH 3 MSL, 630A, 4-pole, bolt M12	148340	1
NH 3 MSL, 630A, 4-pole, V connection	148341	1



148340

Accessories

Item	Item no.	PU
Cable cover for distribution construction, outlet top	148062	1
Cable cover for distributor installation, lowered	148064	1
Claw terminal for MULTIVERT NH MSL size 1, 2, 3 (1 set = 3 pieces)	140192	1
V tab for V terminal size 1-3 (1 set = 3 pieces)	140092	1
V terminals set size 2, 25-300mm², packed	142909/3	1
Insulation cap for V terminals size 2	140099	100
Support bracket for Multivert strip-type switch disconnecter (1 set = 4 pieces)	148069	1



140192



140092



148062

Busbar system
100/185mm

Connection lugs

Item	Item no.	PU
V connection lug size 2, tin-plated	142906/1	50
V connection lug size 00	142907/1	50
V double connecting lugs bridge size 00, 2x50mm ²	202911	1



142906/1

Direct connection V frame terminals

Item	Item no.	PU
V connection terminal size 00, 10-95mm ²	142908	30
V connection terminal size 00, 10-120mm ²	202900	40
V double connection terminal size 00, 50-95mm ²	142912	3
V connection terminal set size 2, 25-300mm ² , packed	142909/1	1
V connection terminal set size 2, 25-300mm ² , packed (1 set = 3 pieces)	142909/3	1
V double connection terminal size 2, 50-240mm ²	142910	10



142908



142912

Insulation caps

Item	Item no.	PU
Insulation cap for V connection terminals size 00	140098	120
Insulation cap for V connection terminals size 2	140099	100



140098

Insert nuts / setting nuts

Item	Item no.	PU
Insert nuts / setting nuts M8	200001	100
Insert nuts / setting nuts M10	200002	100
Insert nuts / setting nuts M12	200003	100



200003

System strip

- ✓ For cable and fixed distribution boards
- ✓ According to VDE 0660 part 500
- ✓ Connection and mounting on the 185mm busbar system

Type-tested by CTI Vienna

Item	Item no.	PU
System strip D02/3 , 185mm system 3x DIN rail 4.5 units (for free assembly)	208000	1
System strip 4S , 185mm system 4x Schuko socket 16A (FI 40/4/0.03 + 4x B16)	208001	1
System strip 2S/1CEE , 185mm system 16A, 5-pole, 2 Schuko socket (FI 40/4/0.03 + 2x C16 + 2x B16)	208002	1
System strip 2xCEE 16A , 185mm system 16A, 5-pole, 400V (FI 40/4/0.03 + 2x C16/3)	208003	1
System strip 2xCEE 32A , 185mm system 32A, 5-pole, 400V (FI 63/4/0.03 + 2x C32/3)	208004	1
System strip 1xCEE 63A , 185mm system 63A, 5-pole, 400V (FI 63/4/0.03 + D02/3)	208005	1



Busbar system
100/185mm

System strip incl. electricity meter

Item	Item no.	PU
System strip 3S/Z , 185mm system 3x Schuko socket + 3x digital exchange electricity meter certified	208006	1
System strip CEE 16/Z , 185mm system 1x CEE 16A + 1x digital three-phase meter certified	208007	1
System strip CEE 32/Z , 185mm system 1x CEE 32A + 1x digital three-phase meter certified	208008	1



Cylinder fuse holder
10x38 mm



Switchgear for cylindrical fuses

Cylinder fuses are becoming increasingly important worldwide. Thanks to the wide variety of fuse characteristics (gG, aM, aR, gR, gPV ...), these fuses have become indispensable for applications up to 125 A. The extensive range of accessories including fuse holders, fuse bases and fuse switch disconnectors enables a wide variety of applications. International approvals, especially for industrial applications, are essential.

Cylinder fuse holder

for fuses: **10x38mm / 14x51mm / 22x58mm / 10x85mm (PV)**

✓ IEC 60947-1 ✓ UL 4248-1 ✓ UL 4248-4 ✓ UL 486E

For fuses: 10x38mm

up to a maximum of 32A / 690V (IEC) / AC22B / 600V (UL)

Item	Item no.	PU
Cylinder fuse holder for 10x38 1-pole IEC/UL	281051	12
Cylinder fuse holder for 10x38 2-pole IEC/UL	281052	6
Cylinder fuse holder for 10x38 3-pole IEC/UL	281053	4



Item	Item no.	PU
Cylinder fuse holder for 10x38 1-pole + N IEC/UL	281041	6
Cylinder fuse holder for 10x38 3-pole + N IEC/UL	281043	3



Item	Item no.	PU
Cylinder fuse holder for 10x38 1-pole IEC/UL with LED	281061	12
Cylinder fuse holder for 10x38 2-pole IEC/UL with LED	281062	6
Cylinder fuse holder for 10x38 3-pole IEC/UL with LED	281063	4



For fuses: 14x51mm

up to a maximum of 50A / 690V (IEC) / AC22B / 600V (UL)

Item	Item no.	PU
Cylinder fuse holder for 14x51 1-pole IEC/UL	281451	12
Cylinder fuse holder for 14x51 2-pole IEC/UL	281452	6
Cylinder fuse holder for 14x51 3-pole IEC/UL	281453	4



Item	Item no.	PU
Cylinder fuse holder for 14x51 1-pole + N IEC/UL	281441	6
Cylinder fuse holder for 14x51 3-pole + N IEC/UL	281443	3

Item	Item no.	PU
Cylinder fuse holder for 14x51 1-pole IEC/UL with LED	281461	12
Cylinder fuse holder for 14x51 2-pole IEC/UL with LED	281462	6
Cylinder fuse holder for 14x51 3-pole IEC/UL with LED	281463	4

For fuses: 22x58mm

up to a maximum of 100A / 690V (IEC) / AC21B / 600V (UL)

Item	Item no.	PU
Cylinder fuse holder for 22x58 1-pole IEC/UL	282251	3
Cylinder fuse holder for 22x58 2-pole IEC/UL	282252	2
Cylinder fuse holder for 22x58 3-pole IEC/UL	282253	1



Item	Item no.	PU
Cylinder fuse holder for 22x58 1-pole + N IEC/UL	282241	2
Cylinder fuse holder for 22x58 3-pole + N IEC/UL	282243	1

Item	Item no.	PU
Cylinder fuse holder for 22x58 1-pole IEC/UL with LED	282261	3
Cylinder fuse holder for 22x58 2-pole IEC/UL with LED	282262	2
Cylinder fuse holder for 22x58 3-pole IEC/UL with LED	282263	1

Item	Item no.	PU
Cylinder fuse holder for 22x58 3-pole + N IEC/UL	302294	1
Cylinder fuse holder for 22x58 3-pole + N IEC/UL	302295	1

PV fuse holder**PV cylinder fuse holder 10x38 mm 1000V DC**

Item	Item no.	PU
PV fuse holder for 10x38 1000V DC	251055	1

**PV cylinder fuse holder 10x85 mm 1500V DC**

Item	Item no.	PU
PV fuse holder for 10x85 1500V DC	302181	1



Cylinder fuse holder

for american industrial fuses: **Class J/30 A**

✓ **UL 4248-1** ✓ **UL 4248-8** ✓ **UL 486E** ✓ **CSA C22.2 No.65** ✓ **CSA C22.2 No.14**

For industrial fuses: Class J/30A

without LED

Item	Item no.	PU
Fuse holder for Class J 30A 1-pole	282351	3
Fuse holder for Class J 30A 2-pole	282352	2
Fuse holder for Class J 30A 3-pole	282353	1



282351



282352



282353

For industrial fuses: Class J/30A

with LED

Item	Item no.	PU
Fuse holder for Class J 30A 1-pole with LED	282361	3
Fuse holder for Class J 30A 2-pole with LED	282362	2
Fuse holder for Class J 30A 3-pole with LED	282363	1



282361



282362



282363

Cylinder fuse holder

for american industrial fuses: **Class CC/bis 30 A**

✓ **UL 4248-1** ✓ **UL 4248-4** ✓ **UL 486E** ✓ **CSA C22.2 No.65**

For industrial fuses: Class CC/bis 30A

without LED

Item	Item no.	PU
Fuse holder for Class CC 1-pole	282051	12
Fuse holder for Class CC 2-pole	282052	6
Fuse holder for Class CC 3-pole	282053	4



Cylinder fuse
switchgear

For industrial fuses: Class CC/bis 30A

with LED

Item	Item no.	PU
Fuse holder for Class CC 1-pole with LED	282061	12
Fuse holder for Class CC 2-pole with LED	282062	6
Fuse holder for Class CC 3-pole with LED	282063	4





Fuses & accessories



The most proven protective devices for electrical current are still the most reliable. Even for the most modern systems, fuses of the most of the most varied types and characteristics offer maximum safety in the event of short circuits and overloads (e.g. DO/NH fuses). The protection of people and systems has been our top priority for over 100 years. The latest technologies such as solar systems, e-cars or energy storage systems would be difficult to protect without fuses!

D0 fuse links

Item	Item no.	PU
D01 fuse link 400V AC/ 250V DC, 2A	100202	50
D01 fuse link 400V AC/ 250V DC, 4A	100204	50
D01 fuse link 400V AC/ 250V DC, 6A	100206	50
D01 fuse link 400V AC/ 250V DC, 10A	100210	50
D01 fuse link 400V AC/ 250V DC, 13A	100213	50
D01 fuse link 400V AC/ 250V DC, 16A	100216	50



100202

Item	Item no.	PU
D02 fuse link 400V AC/ 250V DC, 20A	100220	50
D02 fuse link 400V AC/ 250V DC, 25A	100225	50
D02 fuse link 400V AC/ 250V DC, 32A	100232	50
D02 fuse link 400V AC/ 250V DC, 35A	100235	50
D02 fuse link 400V AC/ 250V DC, 40A	100240	50
D02 fuse link 400V AC/ 250V DC, 50A	100250	50
D02 fuse link 400V AC/ 250V DC, 63A	100263	50



100220

Spar click box

equipped with D0 fuse links

Item	Item no.	PU
D01 fuse links 400V ~ 250V... 2A	101202	1
D01 fuse links 400V ~ 250V... 4A	101204	1
D01 fuse links 400V ~ 250V... 6A	101206	1
D01 fuse links 400V ~ 250V...10A	101210	1
D01 fuse links 400V ~ 250V...13A	101213	1
D01 fuse links 400V ~ 250V...16A	101216	1



101204

Item	Item no.	PU
D02 fuse links 400V ~ 250V...20A	101220	1
D02 fuse links 400V ~ 250V...25A	101225	1
D02 fuse links 400V ~ 250V...32A	101232	1
D02 fuse links 400V ~ 250V...35A	101235	1
D02 fuse links 400V ~ 250V...40A	101240	1
D02 fuse links 400V ~ 250V...50A	101250	1
D02 fuse links 400V ~ 250V...63A	101263	1
D0 full range of fuse links all identification colors (2-63A) 13 x 12 pieces in a click box	101200	1



101250

D0 cartridge ring adapter inserts

Item	Item no.	PU
D01 cartridge ring adapter inserts 2A	100302	50
D01 cartridge ring adapter inserts 4A	100304	50
D01 cartridge ring adapter inserts 6A	100306	50
D01 cartridge ring adapter inserts 10A	100310	50



100304

Item	Item no.	PU
D02 cartridge ring adapter inserts 2A	100402	50
D02 cartridge ring adapter inserts 4A	100404	50
D02 cartridge ring adapter inserts 6A	100406	50
D02 cartridge ring adapter inserts 10A	100410	50
D02 cartridge ring adapter inserts 16A	100416	50
D02 cartridge ring adapter inserts 20A	100420	50
D02 cartridge ring adapter inserts 25A	100425	50
D02 cartridge ring adapter inserts 32A/35A/40A	100435	50
D02 cartridge ring adapter inserts 50A	100450	50



100402

D0 screw caps

Item	Item no.	PU
Fitting sleeve pliers	101400	1
Screw cap D02 plastic with test hole	126024	20
Screw cap D01 plastic with test hole	126025	20
Screw cap D02 porcelain with test hole	127024	20
Screw cap D01 porcelain with test hole	127025	20
Reducing holder spring for D01 fuses	121401	20



101400



126025



121401

NH fuse links

with live grip tabs and combination indicator
according to IEC 60269-2 operating class (gL) gG

Size 000/00 | 500V[~] / 250V-

Item	Item no.	PU
NH fuse size 000, 2A	140602	3
NH fuse size 000, 4A	140604	3
NH fuse size 000, 6A	140606	3
NH fuse size 000, 10A	140610	3
NH fuse size 000, 16A	140616	3
NH fuse size 000, 20A	140620	3
NH fuse size 000, 25A	140625	3
NH fuse size 000, 32A	140632	3
NH fuse size 000, 35A	140635	3
NH fuse size 000, 40A	140640	3
NH fuse size 000, 50A	140650	3
NH fuse size 000, 63A	140663	3
NH fuse size 000, 80A	140680	3
NH fuse size 000, 100A	140690	3
NH fuse size 000, 125A	140693	3
NH fuse size 00, 125A	140691	3
NH fuse size 00, 160A	140692	3



Size 1 | 500V[~] / 440V-

Item	Item no.	PU
NH fuse size 1, 20A	141620	3
NH fuse size 1, 25A	141625	3
NH fuse size 1, 35A	141635	3
NH fuse size 1, 50A	141650	3
NH fuse size 1, 63A	141663	3
NH fuse size 1, 80A	141680	3
NH fuse size 1, 100A	141690	3
NH fuse size 1, 125A	141691	3
NH fuse size 1, 160A	141692	3
NH fuse size 1, 200A	141693	3
NH fuse size 1, 224A	141699	3
NH fuse size 1, 250A	141694	3



Size 2 | 500V~/440V-

Item	Item no.	PU
NH fuse size 2, 50A	142650	3
NH fuse size 2, 63A	142663	3
NH fuse size 2, 80A	142680	3
NH fuse size 2, 100A	142690	3
NH fuse size 2, 125A	142691	3
NH fuse size 2, 160A	142692	3
NH fuse size 2, 200A	142693	3
NH fuse size 2, 224A	142699	3
NH fuse size 2, 250A	142694	3
NH fuse size 2, 300A	142695	3
NH fuse size 2, 315A	142696	3
NH fuse size 2, 355A	142698	3
NH fuse size 2, 400A	142697	3

**Size 3 | 500V~/440V-**

Item	Item no.	PU
NH fuse size 3, 125A	143690	3
NH fuse size 3, 160A	143691	3
NH fuse size 3, 200A	143692	3
NH fuse size 3, 224A	143693	3
NH fuse size 3, 250A	143694	3
NH fuse size 3, 300A	143695	3
NH fuse size 3, 315A	143696	3
NH fuse size 3, 355A	143697	3
NH fuse size 3, 400A	143698	3
NH fuse size 3, 425A	143699	3
NH fuse size 3, 450A	143628	3
NH fuse size 3, 500A	143629	3
NH fuse size 3, 560A	143631	3
NH fuse size 3, 630A	143630	3



NH fuse links 800V AC

with live grip tabs

Size NH00 | gG | 800V AC | 30kA

Item	Item no.	PU
NH fuse size 00, 10A	140610/800	3
NH fuse size 00, 16A	140616/800	3
NH fuse size 00, 20A	140620/800	3
NH fuse size 00, 25A	140625/800	3
NH fuse size 00, 35A	140635/800	3
NH fuse size 00, 40A	140640/800	3
NH fuse size 00, 50A	140650/800	3
NH fuse size 00, 63A	140663/800	3



Image similar

Size NH00 | gS | 800V AC | 30kA

Item	Item no.	PU
NH fuse size 00, 80A	140680/800.GS	3
NH fuse size 00, 100A	140690/800.GS	3
NH fuse size 00, 125A	140691/800.GS	3

Size NH1 | gG | 800V AC | 120kA

Item	Item no.	PU
NH fuse size 1, 35A	141635/800	3
NH fuse size 1, 50A	141650/800	3
NH fuse size 1, 63A	141663/800	3
NH fuse size 1, 80A	141680/800	3
NH fuse size 1, 100A	141690/800	3



Image similar

Size NH1 | gS | 800V AC | 120kA

Item	Item no.	PU
NH fuse size 1, 160A	141692/800.GS	3
NH fuse size 1, 200A	141693/800.GS	3
NH fuse size 1, 250A	141694/800.GS	3

Size NH2 | gS | 800V AC | 120kA

Item	Item no.	PU
NH fuse size 2, 200A	142693/800.GS	3
NH fuse size 2, 250A	142694/800.GS	3
NH fuse size 2, 315A	142696/800.GS	3



Image similar

Size 3 | gG | 800V AC | 120kA

Item	Item no.	PU
NH fuse size 3, 160A	143691/800	3
NH fuse size 3, 200A	143692/800	3
NH fuse size 3, 250A	143694/800	3
NH fuse size 3, 315A	143696/800	3



Image similar

Size 3 | gS | 800V AC | 120kA

Item	Item no.	PU
NH fuse size 3, 400A	143698/800.GS	3

NH cutting knife

With live grip tabs

Item	Item no.	PU
Cutting knife 160A size 000/00, Grip tabs	141700	3
Cutting knife 250A size 1, Grip tabs	141701	3
Cutting knife 400A size 2, Grip tabs	141702	3
Cutting knife 630A size 3, Grip tabs	141703	3



141700

With tension-free grip tabs

Item	Item no.	PU
Cutting knife 160A size 00, Grip tabs	141710	12
Cutting knife 250A size 1, Grip tabs	141711	12
Cutting knife 400A size 2, Grip tabs	141712	6
Cutting knife 630A size 3, Grip tabs	141713	6



141710

Cylindrical fuse links

"gG" without indicator

IEC / EN 60269-1 / 10x38 / 400V AC; 100kA

Item	Item no.	PU
Cylindrical fuse, 10x38, 1A, gL/gG	250601	10
Cylindrical fuse, 10x38, 2A, gL/gG	250602	10
Cylindrical fuse, 10x38, 4A, gL/gG	250604	10
Cylindrical fuse, 10x38, 0.5A, gL/gG	250605	10
Cylindrical fuse, 10x38, 6A, gL/gG	250606	10
Cylindrical fuse, 10x38, 8A, gL/gG	250608	10
Cylindrical fuse, 10x38, 10A, gL/gG	250610	10
Cylindrical fuse, 10x38, 12A, gL/gG	250612	10
Cylindrical fuse, 10x38, 16A, gL/gG	250616	10
Cylindrical fuse, 10x38, 20A, gL/gG	250620	10
Cylindrical fuse, 10x38, 25A, gL/gG	250625	10
Cylindrical fuse, 10x38, 32A, gL/gG	250632	10



250616

14x51 / 500V AC; 80kA

Item	Item no.	PU
Cylindrical fuse, 14x51, 2A, gL/gG	251602	10
Cylindrical fuse, 14x51, 4A, gL/gG	251604	10
Cylindrical fuse, 14x51, 6A, gL/gG	251606	10
Cylindrical fuse, 14x51, 8A, gL/gG	251608	10
Cylindrical fuse, 14x51, 10A, gL/gG	251610	10
Cylindrical fuse, 14x51, 16A, gL/gG	251616	10
Cylindrical fuse, 14x51, 20A, gL/gG	251620	10
Cylindrical fuse, 14x51, 25A, gL/gG	251625	10
Cylindrical fuse, 14x51, 32A, gL/gG	251632	10
Cylindrical fuse, 14x51, 40A, gL/gG	251640	10
Cylindrical fuse, 14x51, 50A, gL/gG	251650	10



251606

Cylindrical fuse links

for photovoltaics

10x38

Item	Item no.	PU
PV cylindrical fuse, 10x38, 1000V/DC, 1A	291001	10
PV cylindrical fuse, 10x38, 1000V/DC, 2A	291002	10
PV cylindrical fuse, 10x38, 1000V/DC, 3A	291003	10
PV cylindrical fuse, 10x38, 1000V/DC, 4A	291004	10
PV cylindrical fuse, 10x38, 1000V/DC, 5A	291005	10
PV cylindrical fuse, 10x38, 1000V/DC, 6A	291006	10
PV cylindrical fuse, 10x38, 1000V/DC, 8A	291008	10
PV cylindrical fuse, 10x38, 1000V/DC, 10A	291010	10
PV cylindrical fuse, 10x38, 1000V/DC, 12A	291012	10
PV cylindrical fuse, 10x38, 1000V/DC, 16A	291016	10
PV cylindrical fuse, 10x38, 1000V/DC, 20A	291020	10
PV cylindrical fuse, 10x38, 1000V/DC, 25A	291025	10



10x85

Item	Item no.	PU
PV cylindrical fuse, 10x85, 1500V/DC, 2A	291102	10
PV cylindrical fuse, 10x85, 1500V/DC, 4A	291104	10
PV cylindrical fuse, 10x85, 1500V/DC, 5A	291105	10
PV cylindrical fuse, 10x85, 1500V/DC, 6A	291106	10
PV cylindrical fuse, 10x85, 1500V/DC, 8A	291108	10
PV cylindrical fuse, 10x85, 1500V/DC, 10A	291110	10
PV cylindrical fuse, 10x85, 1500V/DC, 12A	291112	10
PV cylindrical fuse, 10x85, 1500V/DC, 15A	291115	10
PV cylindrical fuse, 10x85, 1500V/DC, 16A	291116	10
PV cylindrical fuse, 10x85, 1500V/DC, 20A	291120	10
PV cylindrical fuse, 10x85, 1500V/DC, 25A	291125	10
PV cylindrical fuse, 10x85, 1500V/DC, 30A	291130	10



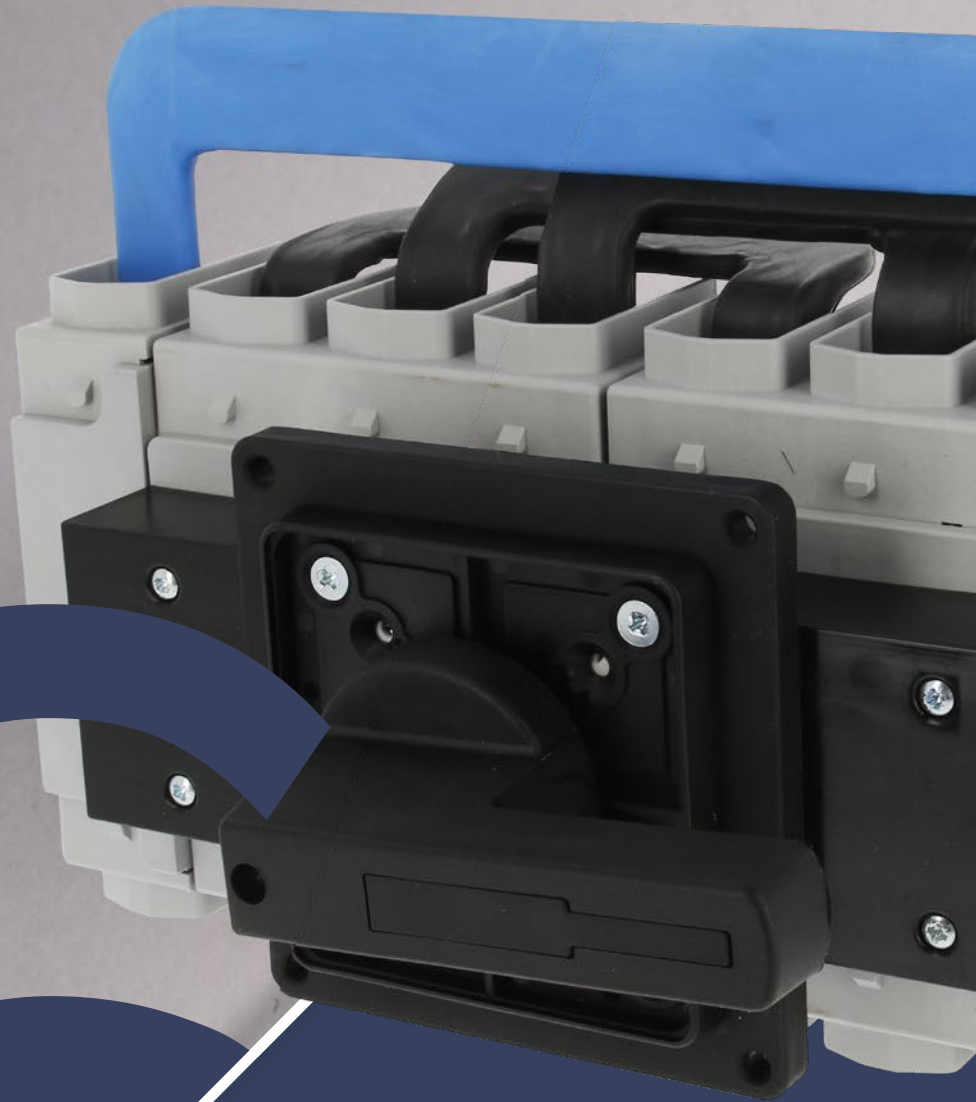

Diverter switch

Main & emergency stop switches & Accessories



Main &
emergency stop
switches

Main switches, emergency stop switches and diverter switches are essential components of electrical engineering. The emergency stop switch ensures the rapid shutdown of machines and systems in hazardous situations, while main switches serve as reliable switch-on and switch-off devices. In the field of photovoltaics and emergency power supply in particular, diverter switches have established themselves as important components and make an important contribution to the energy transition.

Fixing options

Floor fixing

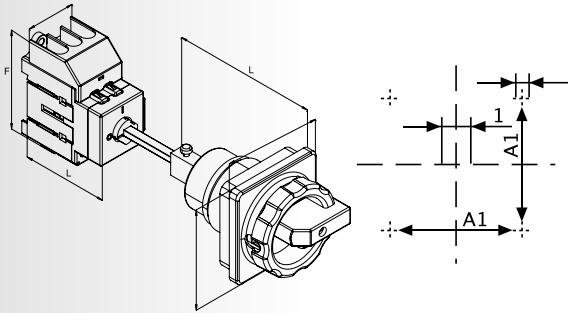

Central hole fixing

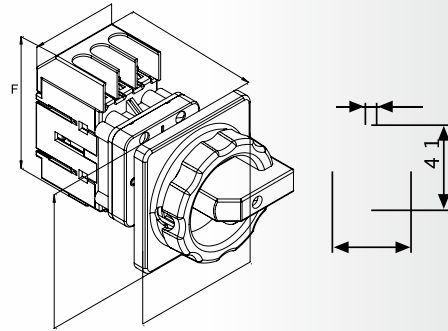

DIN rail fixing

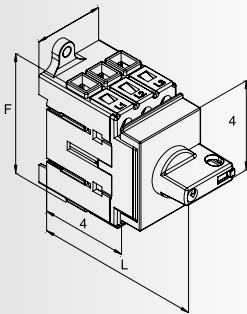

4-hole fixing

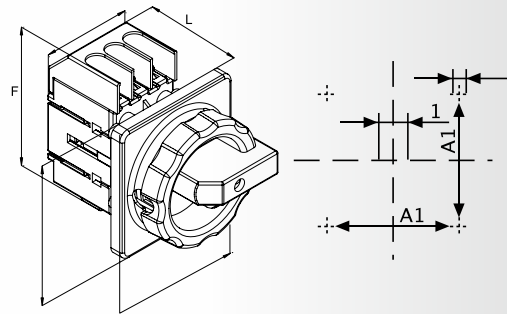

Diverter switch/ Repair switch

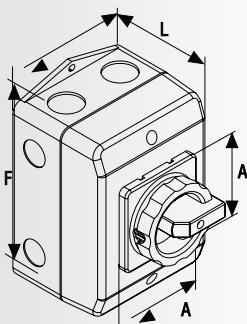

Additional & auxiliary contacts

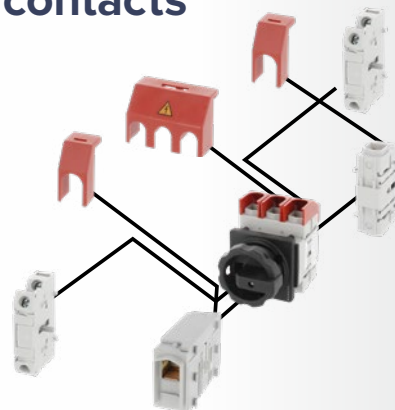

Emergency stop switch (NAS)

Floor fixing 3-pole

Item 3-pole	Thermal rated current I_{th}	Rated power at 3x400V (AC3)	Rated power at 3x400V (AC23)	Connection cross section	Item no.	PU
NAS, 3-pole	16 A	5.5 kW	7.5 kW	16 mm ²	350320	1
NAS, 3-pole	25 A	7.5 kW	9.5 kW	16 mm ²	350332	1
NAS, 3-pole	32 A	9.5 kW	11.5 kW	16 mm ²	351332	1
NAS, 3-pole	40 A	11.5 kW	15 kW	16 mm ²	351340	1
NAS, 3-pole	63 A	18.5 kW	22.5 kW	35 mm ²	351363	1
NAS, 3-pole	80 A	22 kW	30 kW	35 mm ²	351380	1
NAS, 3-pole	100 A	30 kW	37 kW	50 mm ²	351310	1
NAS, 3-pole	125 A	37 kW	45 kW	50 mm ²	351312	1
NAS, 3-pole	180 A	75 kW	90 kW	185 mm ²	351318	1
NAS, 3-pole	250 A	110 kW	132 kW	185 mm ²	351325	1



Floor fixing 4-pole

Item 4-pole	Thermal rated current I_{th}	Rated power at 3x400V (AC3)	Rated power at 3x400V (AC23)	Connection cross section	Item no.	PU
NAS, 4-pole	16 A	5.5 kW	7.5 kW	25 mm ²	351317	1
NAS, 4-pole	25 A	7.5 kW	9.5 kW	25 mm ²	351326	1
NAS, 4-pole	32 A	9 kW	11.5 kW	25 mm ²	351333	1
NAS, 4-pole	40 A	11.5 kW	15 kW	25 mm ²	351341	1
NAS, 4-pole	63 A	18.5 kW	22 kW	16 mm ²	351364	1
NAS, 4-pole	80 A	22 kW	30 kW	35 mm ²	351381	1
NAS, 4-pole	100 A	30 kW	37 kW	50 mm ²	351311	1
NAS, 4-pole	125 A	37 kW	45 kW	50 mm ²	351313	1
NAS, 4-pole	180 A	75 kW	90 kW	185 mm ²	351319	1
NAS, 4-pole	250 A	110 kW	132 kW	185 mm ²	351327	1

Main & emergency stop switches

Floor fixing according to UL 489

Item	Thermal rated current I_{th}	Connection cross section	Item no.	PU
NAS, 3-pole, LX80, 30 A AC (acc to UL 489 / UL 508/ UL 60947-4-1) 480 V AC at 50–60Hz (acc to UL 489 / UL 508)	32 A	35 mm ²	351580	1
NAS, 3-pole, LX125, 60 A AC (acc to UL 489 / UL 508/ UL 60947-4-1) 480 V AC at 50–60Hz (acc to UL 489 / UL 508)	63 A	50 mm ²	351512	1
NAS, 3-pole, LX160, 100 A AC (acc to UL 489 / UL 508/ UL 60947-4-1) 480 V AC at 50–60Hz (acc to UL 489 / UL 508)	100 A	185 mm ²	351516	1
NAS, 3-pole, LX250, 100 A AC (acc to UL 489 / UL 508/ UL 60947-4-1) 480 V AC at 50–60Hz (acc to UL 489 / UL 508)	160 A	185 mm ²	351525	1

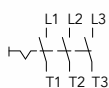

3-pole

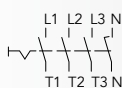

4-pole

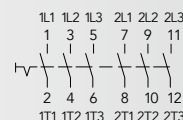

6-pole

Central hole fixing 3-pole

Item 3-pole	Thermal rated current I_{th}	Rated power at 3x400V (AC3)	Rated power at 3x400V (AC23)	Connection cross section	Item no.	PU
NAS, 3-pole	16 A	5.5 kW	7.5 kW	16 mm ²	351216	1
NAS, 3-pole	25 A	7.5 kW	9 kW	16 mm ²	351225	1
NAS, 3-pole	32 A	9.5 kW	11 kW	16 mm ²	351232	1
NAS, 3-pole	40 A	11.5 kW	15 kW	16 mm ²	351240	1
NAS, 3-pole	63 A	18.5 kW	22.5 kW	16 mm ²	351263	1
NAS, 3-pole	80 A	22 kW	30 kW	35 mm ²	351280	1



Central hole fixing 4-pole

Item 4-pole	Thermal rated current I_{th}	Rated power at 3x400V (AC3)	Rated power at 3x400V (AC23)	Connection cross section	Item no.	PU
NAS, 4-pole	16 A	5.5 kW	7.5 kW	16 mm ²	351217	1
NAS, 4-pole	25 A	7.5 kW	9 kW	16 mm ²	351226	1
NAS, 4-pole	32 A	9.5 kW	11.5 kW	16 mm ²	351233	1
NAS, 4-pole	40 A	11.5 kW	15 kW	16 mm ²	351241	1
NAS, 4-pole	63 A	18.5 kW	22.5 kW	16 mm ²	351264	1
NAS, 4-pole	80 A	22 kW	30 kW	35 mm ²	351281	1

DIN norm distribution (DIN rail fixing) 3-pole

Item 3-pole	Thermal rated current I_{th}	Rated power at 3x400V (AC3)	Rated power at 3x400V (AC23)	Connection cross section	Item no.	PU
NAS, 3-pole	16 A	5.5 kW	7.5 kW	16 mm ²	351416	1
NAS, 3-pole	25 A	7.5 kW	9 kW	16 mm ²	351425	1
NAS, 3-pole	32 A	9.5 kW	11.5 kW	16 mm ²	351432	1
NAS, 3-pole	40 A	11.5 kW	15 kW	16 mm ²	351440	1
NAS, 3-pole	63 A	18.5 kW	22.5 kW	16 mm ²	351463	1
NAS, 3-pole	80 A	22 kW	30 kW	35 mm ²	351480	1
NAS, 3-pole	100 A	30 kW	37 kW	50 mm ²	351410	1
NAS, 3-pole	125 A	37 kW	45 kW	50 mm ²	351412	1



DIN norm distribution (DIN rail fixing) 4-pole

Item 4-pole	Thermal rated current I_{th}	Rated power at 3x400V (AC3)	Rated power at 3x400V (AC23)	Connection cross section	Item no.	PU
NAS, 4-pole	16 A	5.5 kW	7.5 kW	16 mm ²	351417	1
NAS, 4-pole	25 A	7.5 kW	9 kW	16 mm ²	351426	1
NAS, 4-pole	32 A	9.5 kW	11.5 kW	16 mm ²	351433	1
NAS, 4-pole	40 A	11.5 kW	15 kW	16 mm ²	351441	1
NAS, 4-pole	63 A	18.5 kW	22.5 kW	16 mm ²	351464	1
NAS, 4-pole	80 A	22 kW	30 kW	35 mm ²	351481	1
NAS, 4-pole	100 A	30 kW	37 kW	50 mm ²	351411	1
NAS, 4-pole	125 A	37 kW	45 kW	50 mm ²	351413	1

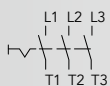

3-pole

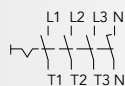

4-pole

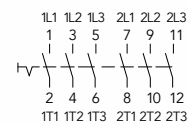

6-pole

4-hole fixing 3-pole

Item 3-pole	Thermal rated current I_{th}	Rated power at 3x400V (AC3)	Rated power at 3x400V (AC23)	Connection cross section	Item no.	PU
NAS, 3-pole	16 A	5.5 kW	7.5 kW	16 mm ²	350116	1
NAS, 3-pole	25 A	7.5 kW	9 kW	16 mm ²	351120	1
NAS, 3-pole	32 A	9.5 kW	11.5 kW	16 mm ²	350132	1
NAS, 3-pole	40 A	11.5 kW	15 kW	16 mm ²	351140	1
NAS, 3-pole	63 A	18.5 kW	22.5 kW	16 mm ²	351163	1
NAS, 3-pole	80 A	22 kW	30 kW	35 mm ²	351180	1
NAS, 3-pole	100 A	30 kW	37 kW	50 mm ²	351110	1
NAS, 3-pole	125 A	37 kW	45 kW	50 mm ²	351112	1
NAS, 3-pole	180 A	75 kW	90 kW	185 mm ²	351118	1
NAS, 3-pole	250 A	110 kW	132 kW	185 mm ²	351125	1
NAS, 3-pole	315 A	110 kW	132 kW	185 mm ²	351131	1



351112



351120

4-hole fixing 4-pole

Item 4-pole	Thermal rated current I_{th}	Rated power at 3x400V (AC3)	Rated power at 3x400V (AC23)	Connection cross section	Item no.	PU
NAS, 4-pole	16 A	5.5 kW	7.5 kW	16 mm ²	351117	1
NAS, 4-pole	25 A	7.5 kW	9 kW	16 mm ²	351126	1
NAS, 4-pole	32 A	9.5 kW	11.5 kW	16 mm ²	351133	1
NAS, 4-pole	40 A	11.5 kW	15 kW	16 mm ²	351141	1
NAS, 4-pole	63 A	18.5 kW	22.5 kW	16 mm ²	351164	1
NAS, 4-pole	80 A	22 kW	30 kW	35 mm ²	351181	1
NAS, 4-pole	100 A	30 kW	37 kW	50 mm ²	351111	1
NAS, 4-pole	125 A	37 kW	45 kW	50 mm ²	351113	1
NAS, 4-pole	180 A	75 kW	90 kW	185 mm ²	351119	1
NAS, 4-pole	250 A	110 kW	132 kW	185 mm ²	351127	1
NAS, 4-pole	315 A	110 kW	132 kW	185 mm ²	351134	1

Main & emergency stop switches

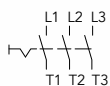

3-pole



4-pole

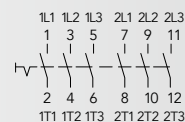

6-pole

Main switch (HS)

Floor fixing 3-pole

Item 3-pole	Thermal rated current I_{th}	Rated power at 3x400V (AC3)	Rated power at 3x400V (AC23)	Connection cross section	Item no.	PU
HS, 3-pole	16 A	5.5 kW	7.5 kW	16 mm ²	352316	1
HS, 3-pole	25 A	7.5 kW	9 kW	16 mm ²	352324	1
HS, 3-pole	32 A	9.5 kW	11.5 kW	16 mm ²	352332	1
HS, 3-pole	40 A	11.5 kW	15 kW	16 mm ²	352340	1
HS, 3-pole	63 A	18.5 kW	22 kW	16 mm ²	352363	1
HS, 3-pole	80 A	22 kW	30 kW	35 mm ²	352380	1
HS, 3-pole	100 A	30 kW	37 kW	50 mm ²	352310	1
HS, 3-pole	125 A	37 kW	45 kW	50 mm ²	352312	1
HS, 3-pole	180 A	75 kW	90 kW	185 mm ²	352318	1
HS, 3-pole	250 A	110 kW	132 kW	185 mm ²	352325	1
HS, 3-pole	315 A	110 kW	132 kW	185 mm ²	352327	1



Floor fixing 4-pole

Item 4-pole	Thermal rated current I_{th}	Rated power at 3x400V (AC3)	Rated power at 3x400V (AC23)	Connection cross section	Item no.	PU
HS, 4-pole	16 A	5.5 kW	7.5 kW	16 mm ²	352317	1
HS, 4-pole	25 A	7.5 kW	9.5 kW	16 mm ²	352323	1
HS, 4-pole	32 A	9.5 kW	11.5 kW	16 mm ²	352333	1
HS, 4-pole	40 A	11.5 kW	15 kW	16 mm ²	352341	1
HS, 4-pole	63 A	18.5 kW	22 kW	16 mm ²	352365	1
HS, 4-pole	80 A	22 kW	30 kW	35 mm ²	352381	1
HS, 4-pole	100 A	30 kW	37 kW	50 mm ²	352311	1
HS, 4-pole	125 A	37 kW	45 kW	50 mm ²	352313	1
HS, 4-pole	180 A	75 kW	90 kW	185 mm ²	352319	1
HS, 4-pole	250 A	110 kW	132 kW	185 mm ²	352326	1
HS, 4-pole	315 A	110 kW	132 kW	185 mm ²	352331	1



Floor fixing according to UL 489

Item	Thermal rated current I_{th}	Connection cross section	Item no.	PU
HS, 3-pole, LX80, 30 A AC (acc to UL 489 / UL 508/ UL 60947-4-1) 480 V AC at 50–60Hz (acc to UL 489 / UL 508)	32 A	35 mm ²	352580	1
HS, 3-pole, LX125, 60 A AC (acc to UL 489 / UL 508/ UL 60947-4-1) 480 V AC at 50–60Hz (acc to UL 489 / UL 508)	63 A	50 mm ²	352512	1
HS, 3-pole, LX160, 100 A AC (acc to UL 489 / UL 508/ UL 60947-4-1) 480 V AC at 50–60Hz (acc to UL 489 / UL 508)	100 A	185 mm ²	352516	1
HS, 3-pole, LX180, 125 A AC (acc to UL 489 / UL 508/ UL 60947-4-1) 480 V AC at 50–60Hz (acc to UL 489 / UL 508)	125 A	185 mm ²	352518	1

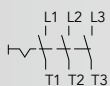

3-pole

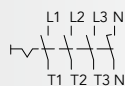

4-pole

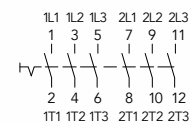

6-pole

Central hole fixing 3-pole

Item 3-pole	Thermal rated current I_{th}	Rated power at 3x400V (AC3)	Rated power at 3x400V (AC23)	Connection cross section	Item no.	PU
HS, 3-pole	16 A	5.5 kW	7.5 kW	16 mm ²	352216	1
HS, 3-pole	25 A	7.5 kW	9 kW	16 mm ²	352225	1
HS, 3-pole	32 A	9.5 kW	11.5 kW	16 mm ²	352232	1
HS, 3-pole	40 A	11 kW	15 kW	16 mm ²	352240	1
HS, 3-pole	63 A	18.5 kW	22 kW	16 mm ²	352263	1
HS, 3-pole	80 A	22 kW	30 kW	35 mm ²	352280	1



Central hole fixing 4-pole

Item 4-pole	Thermal rated current I_{th}	Rated power at 3x400V (AC3)	Rated power at 3x400V (AC23)	Connection cross section	Item no.	PU
HS, 4-pole	16 A	5.5 kW	7.5 kW	16 mm ²	352217	1
HS, 4-pole	25 A	7.5 kW	9 kW	16 mm ²	352226	1
HS, 4-pole	32 A	9.5 kW	11.5 kW	16 mm ²	352233	1
HS, 4-pole	40 A	11 kW	15 kW	16 mm ²	352241	1
HS, 4-pole	63 A	18.5 kW	22 kW	16 mm ²	352264	1
HS, 4-pole	80 A	22 kW	30 kW	35 mm ²	352281	1

DIN rail fixing (DIN norm distribution) 3-pole

Item 3-pole	Thermal rated current I_{th}	Rated power at 3x400V (AC3)	Rated power at 3x400V (AC23)	Connection cross section	Item no.	PU
HS, 3-pole	16 A	5.5 kW	7.5 kW	16 mm ²	352416	1
HS, 3-pole	25 A	7.5 kW	9 kW	16 mm ²	352425	1
HS, 3-pole	32 A	9.5 kW	11.5 kW	16 mm ²	352432	1
HS, 3-pole	40 A	11 kW	15 kW	16 mm ²	352440	1
HS, 3-pole	63 A	18.5 kW	22 kW	16 mm ²	352463	1
HS, 3-pole	80 A	22 kW	30 kW	35 mm ²	352480	1
HS, 3-pole	100 A	30 kW	37 kW	50 mm ²	352410	1
HS, 3-pole	125 A	37 kW	45 kW	50 mm ²	352412	1



Main & emergency stop switches

DIN rail fixing (DIN norm distribution) 4-pole

Item 4-pole	Thermal rated current I_{th}	Rated power at 3x400V (AC3)	Rated power at 3x400V (AC23)	Connection cross section	Item no.	PU
HS, 4-pole	16 A	5.5 kW	7.5 kW	16 mm ²	352417	1
HS, 4-pole	25 A	7.5 kW	9 kW	16 mm ²	352426	1
HS, 4-pole	32 A	9.5 kW	11.5 kW	16 mm ²	352433	1
HS, 4-pole	40 A	11 kW	15 kW	16 mm ²	352441	1
HS, 4-pole	63 A	18.5 kW	22 kW	16 mm ²	352464	1
HS, 4-pole	80 A	22 kW	30 kW	35 mm ²	352481	1
HS, 4-pole	100 A	30 kW	37 kW	50 mm ²	352411	1
HS, 4-pole	125 A	37 kW	45 kW	50 mm ²	352413	1

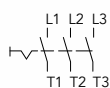

3-pole



4-pole

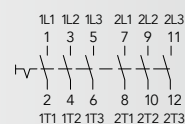

6-pole

4-hole fixing 3-pole

Item 3-pole	Thermal rated current I_{th}	Rated power at 3x400V (AC3)	Rated power at 3x400V (AC23)	Connection cross section	Item no.	PU
HS, 3-pole	16 A	5.5 kW	7.5 kW	16 mm ²	352116	1
HS, 3-pole	25 A	7.5 kW	9.5 kW	16 mm ²	352124	1
HS, 3-pole	32 A	9.5 kW	11.5 kW	16 mm ²	352132	1
HS, 3-pole	40 A	11 kW	15 kW	16 mm ²	352140	1
HS, 3-pole	63 A	18.5 kW	22 kW	16 mm ²	352163	1
HS, 3-pole	80 A	22 kW	30 kW	35 mm ²	352180	1
HS, 3-pole	100 A	30 kW	37 kW	50 mm ²	352110	1
HS, 3-pole	125 A	37 kW	45 kW	50 mm ²	352112	1
HS, 3-pole	180 A	75 kW	90 kW	185 mm ²	352118	1
HS, 3-pole	250 A	110 kW	132 kW	185 mm ²	352125	1
HS, 3-pole	315 A	110 kW	132 kW	185 mm ²	352131	1



4-hole fixing 4-pole

Item 4-pole	Thermal rated current I_{th}	Rated power at 3x400V (AC3)	Rated power at 3x400V (AC23)	Connection cross section	Item no.	PU
HS, 4-pole	16 A	5.5 kW	7.5 kW	16 mm ²	352116-4	1
HS, 4-pole	25 A	7.5 kW	9.5 kW	16 mm ²	352126	1
HS, 4-pole	32 A	9.5 kW	11.5 kW	16 mm ²	352133	1
HS, 4-pole	40 A	11 kW	15 kW	16 mm ²	352141	1
HS, 4-pole	63 A	18.5 kW	22 kW	16 mm ²	352164	1
HS, 4-pole	80 A	22 kW	30 kW	35 mm ²	352181	1
HS, 4-pole	100 A	30 kW	37 kW	50 mm ²	352111	1
HS, 4-pole	125 A	37 kW	45 kW	50 mm ²	352113	1
HS, 4-pole	180 A	75 kW	90 kW	185 mm ²	352618	1
HS, 4-pole	250 A	110 kW	132 kW	185 mm ²	352127	1
HS, 4-pole	315 A	110 kW	132 kW	185 mm ²	352135	1

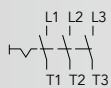

3-pole

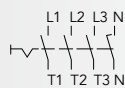

4-pole

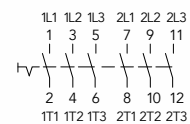

6-pole

Diverter switch (LUS)

Floor fixing 4-pole

Item 4-pole	Thermal rated current I_{th}	Rated power at 3x400V (AC3)	Rated power at 3x400V (AC23)	Connection cross section	Item no.	PU
LUS, 4-pole	180 A	75 kW	90 kW	185 mm ²	353161	1
LUS, 4-pole	250 A	110 kW	132 kW	185 mm ²	353251	1
LUS, 4-pole	400 A	110 kW	132 kW	185 mm ²	353065	1

DIN norm distribution (Netz-O-Not) 4-polig

Item 4-pole	Thermal rated current I_{th}	Rated power at 3x400V (AC3)	Rated power at 3x400V (AC23)	Connection cross section	Item no.	PU
LUS, 4-pole	25 A	7.5 kW	9 kW	25 mm ²	353026	1
LUS, 4-pole	40 A	11 kW	20 kW	25 mm ²	353040	1
LUS, 4-pole	63 A	18.5 kW	22.5 kW	25 mm ²	353063	1
LUS, 4-pole	80 A	22 kW	30 kW	35 mm ²	353080	1
LUS, 4-pole	125 A	37 kW	45 kW	50 mm ²	353125	1
LUS, 4-pole	180 A	75 kW	90 kW	185 mm ²	353160	1



Encapsulated 4-pole

Item 4-pole	Thermal rated current I_{th}	Rated power at 3x400V (AC3)	Rated power at 3x400V (AC23)	Connection cross section	Item no.	PU
LUS, 4-pole	40 A	11 kW	20 kW	25 mm ²	356040	1
LUS, 4-pole	63 A	18.5 kW	22 kW	16 mm ²	356063	1
LUS, 4-pole	80 A	22 kW	30 kW	35 mm ²	356080	1
LUS, 4-pole	125 A	37 kW	45 kW	50 mm ²	356125	1
LUS, 4-pole	180 A	75 kW	90 kW	185 mm ²	356180	1
LUS, 4-pole	250 A	110 kW	132 kW	185 mm ²	356250	1



4-hole fixing (Netz-O-Not) 4-pole

Item 4-pole	Thermal rated current I_{th}	Rated power at 3x400V (AC3)	Rated power at 3x400V (AC23)	Connection cross section	Item no.	PU
LUS, 4-pole	25 A	7.5 kW	9.5 kW	25 mm ²	353025	1
LUS, 4-pole	63 A	18.5 kW	22 kW	25 mm ²	353066	1
LUS, 4-pole	250 A	110 kW	132 kW	185 mm ²	353250	1



Main & emergency stop switches

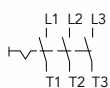

3-pole

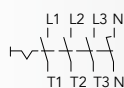

4-pole



6-pole

Auxiliary switch

Item 1-pole	Connection cross section	Item no.	PU
Auxiliary switch 1S+1Ö (for 4 hole fixing, central hole fixing)	2x 0.75 mm ²	359000	1
Auxiliary switch 1S+1Ö (for floor fixing, DIN rail)	2x 0.75 mm ²	359001	1



Repair switch (RS)

3-pole

Item 3-pole	Thermal rated current I _{th}	Connection cross section	Item no.	PU
RS, 3-pole, encapsulated	16 A	16 mm ²	354016	1
RS, 3-pole, encapsulated	25 A	16 mm ²	354025	1
RS, 3-pole, encapsulated	32 A	16 mm ²	354032	1
RS, 3-pole, encapsulated	40 A	16 mm ²	354040	1
RS, 3-pole, encapsulated	63 A	16 mm ²	354063	1
RS, 3-pole, encapsulated	80 A	35 mm ²	354080	1
RS, 3-pole, encapsulated	100 A	50 mm ²	354010	1
RS, 3-pole, encapsulated	125 A	50 mm ²	354012	1
RS, 3-pole, encapsulated	180 A	185 mm ²	354018	1
RS, 3-pole, encapsulated	250 A	185 mm ²	354027	1



4-pole

Item 4-pole	Thermal rated current I _{th}	Connection cross section	Item no.	PU
RS, 4-pole, encapsulated	16 A	16 mm ²	354017	1
RS, 4-pole, encapsulated	25 A	16 mm ²	354026	1
RS, 4-pole, encapsulated	32 A	16 mm ²	354033	1
RS, 4-pole, encapsulated	40 A	16 mm ²	354041	1
RS, 4-pole, encapsulated	63 A	16 mm ²	354064	1
RS, 4-pole, encapsulated	80 A	35 mm ²	354081	1
RS, 4-pole, encapsulated	100 A	50 mm ²	354011	1
RS, 4-pole, encapsulated	125 A	50 mm ²	354013	1
RS, 4-pole, encapsulated	180 A	185 mm ²	354019	1
RS, 4-pole, encapsulated	250 A	185 mm ²	354028	1

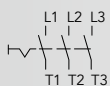

3-pole

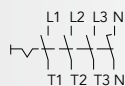

4-pole

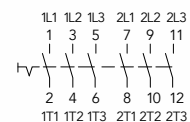

6-pole

Neutral wire

For floor fixing and DIN norm distribution

Item 1-pole	Item no.	PU
Neutral wire leading switching for switches with 16mm ² connection cross section	359363	1
Neutral wire leading switching for switches with 35mm ² connection cross section	359380	1
Neutral wire leading switching for switches with 50mm ² connection cross section	359312	1
Neutral wire leading switching for switches with 185mm ² connection cross section	359325	1



For 4-hole fixing and central hole fixing

Item 1-pole	Item no.	PU
Neutral wire leading switching for switches with 16mm ² connection cross section	359263	1
Neutral wire leading switching for switches with 35mm ² connection cross section	359280	1
Neutral wire leading switching for switches with 50mm ² connection cross section	359212	1
Neutral wire leading switching for switches with 185mm ² connection cross section	359225	1



Main & emergency stop switches

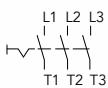

3-pole

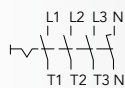

4-pole

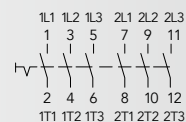

6-pole

Accessories

1-pole

Item 1-pole	Item no.	PU
Terminal cover 1-pole, for switches with 16mm ² connection cross section	358163	1
Terminal cover 1-pole, for switches with 35mm ² connection cross section	358180	1
Terminal cover 1-pole, for switches with 50mm ² connection cross section	358112	1
Terminal cover 1-pole, for switches with 185mm ² connection cross section	358125	1



3-pole

Item 3-pole	Item no.	PU
Terminal cover 3-pole, for switches with 16mm ² connection cross section	358363	1
Terminal cover 3-pole, for switches with 35mm ² connection cross section	358380	1
Terminal cover 3-pole, for switches with 50mm ² connection cross section	358312	1
Terminal cover 3-pole, for switches with 185mm ² connection cross section	358325	1



Item 3-pole	Item no.	PU
D1 shaft set, for rotary actuator shaft, for wrs (wrs = with removable shaft), length 300mm, Ø 6mm	350302	1
D2 shaft set, for rotary actuator shaft, for wrs (wrs = with removable shaft), length 300mm, Ø 8mm	350304	1
D1 shaft set, for rotary actuator shaft, for wrs (wrs = with removable shaft), length 600mm, Ø 6mm	350307	1
D2 shaft set, for rotary actuator shaft, for wrs (wrs = with removable shaft), length 600mm, Ø 8mm	350309	1



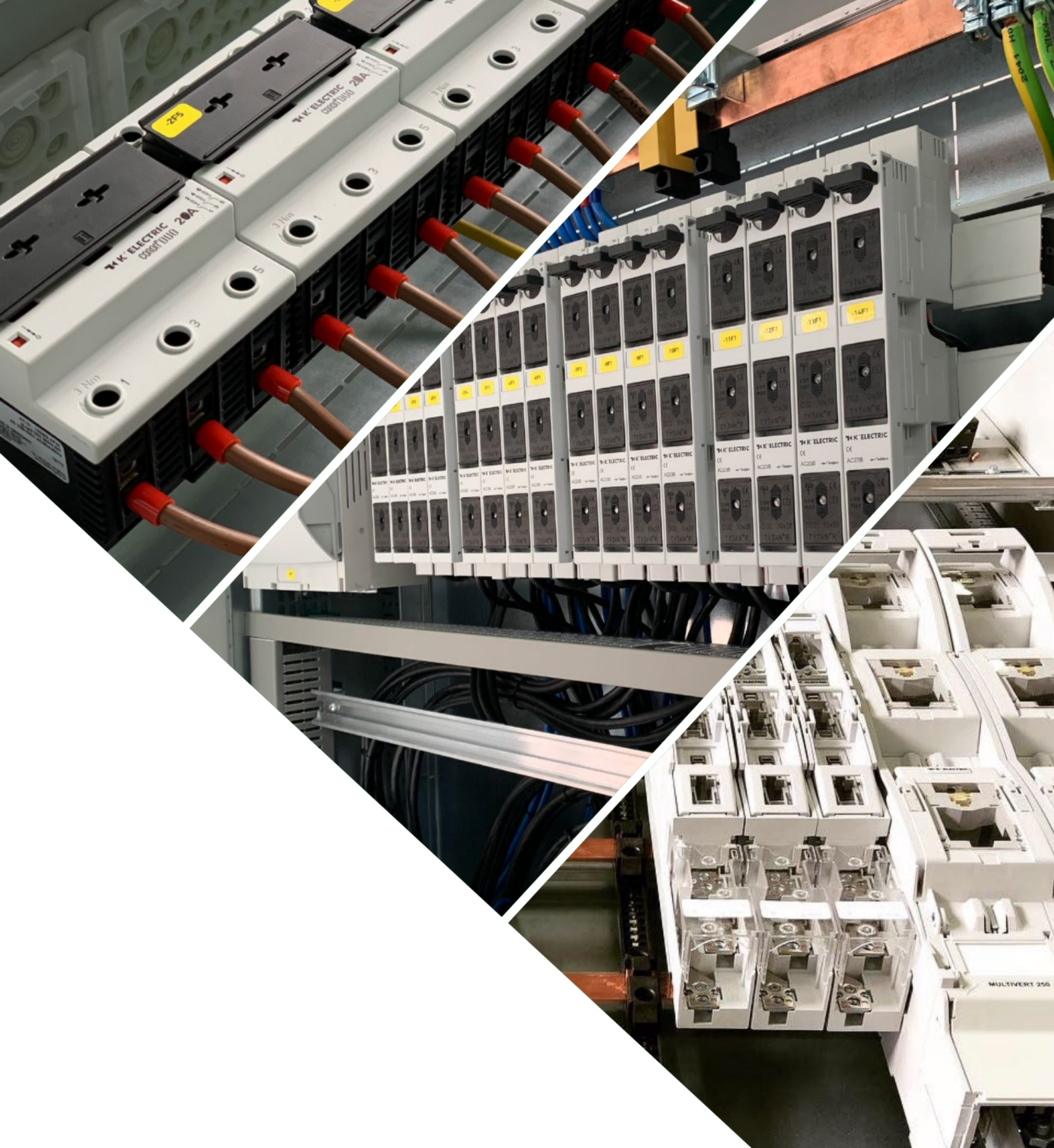

**OUR
PRODUCTS
IN USE...**



Mains monitoring measuring relay

Measuring relay technology



The monitoring of phase failures, undervoltages and overvoltages in systems that supply critical areas or sensitive devices are important components in electrical engineering. Our compact 1 unit monitoring relays with fixed/adjustable parameters (switching point/switching time), reliably perform these tasks for AC/DC systems. The advantages lie in the simple wiring (e.g. 1-phase operation), as no complex bridges are required at the voltage inputs. Even for complex systems where frequencies, asymmetries, 3P without N and programmable changeover contacts are required, our adjustable display mains relay is the ideal solution.

Under-voltage relay

standard

- ✓ 3-phase monitoring for under-voltage and phase release
- ✓ N conductor monitoring
- ✓ Construction width 17.8mm (1 unit)
- ✓ Switching voltage 85%, delay 0.5 sec
- ✓ Power consumption under 1W
- ✓ Test button

Item	Item no.	PU
Under-voltage relay 2 changer, test button	103030	1
Under-voltage relay 2 changer, test button, rotating field detection	103031	1



Under-voltage relay

with extended range of functions

- ✓ 3-phase monitoring for under-voltage, phase release
- ✓ N conductor monitoring
- ✓ Construction width 17.8mm (1 unit)
- ✓ Switching voltage 85%, delay 0.5 sec
- ✓ Power consumption under 1W
- ✓ LED error display for phase and N-fault
- ✓ For 1-phase applications, Comfort connection L/N integrated (time-consuming bridging of the conductors L1, L2 and L3 is no longer necessary)
- ✓ Switch-back delay 1min (10 3062)
- ✓ Suitable for emergency lighting applications to DIN VDE 0100-560 (10 3071)

Item	Item no.	PU
Under-voltage relay 3 LED, 1 changer	103059	1
Under-voltage relay 3 LED, 2 changer	103060	1
Under-voltage relay, 2 changer	103062	1
Under-voltage relay 3 LED with phase indicator, 2 changer	103069	1



According to DIN VDE 0100-560

(Switching voltage: 60% / Switch-back voltage: 85%)

Item	Item no.	PU
Under-voltage relay according to DIN VDE 0100-560, switching voltage 60% / 85%, 4 LED for phase indicator and N-fault	103071	1/18
Under-voltage relay according to DIN VDE 0100-560, switching voltage 60% / 85%, 1 LED for status display	103039	1/18



Under-voltage relay

with rotating field detection

- ✓ 3-phase monitoring for under-voltage, phase release and phase sequence
- ✓ N conductor monitoring
- ✓ Construction width 17.8mm (1 unit)
- ✓ Switching voltage 85%, delay 0.5 sec
- ✓ Power consumption under 1W
- ✓ LED error display for rotating field, phase and N-fault
- ✓ Test button
- ✓ For 1-phase operation direct connection possible via terminal L; N

Item	Item no.	PU
Under-voltage relay with rotating field detection and test button, 2 changer	103061	1



Under-voltage relay

adjustable

- ✓ 3-phase monitoring for under-voltage, phase release and phase sequence
- ✓ N conductor monitoring
- ✓ Construction width 17.8mm (1 unit)
- ✓ Switching voltage adjustable
- ✓ Time delay adjustable
- ✓ Power consumption under 1W
- ✓ LED error display
- ✓ For 1-phase applications, Comfort connection L/N integrated (time-consuming bridging of the conductors L1, L2 and L3 is no longer necessary)

Item	Item no.	PU
Under-voltage relay adjustable, 2 changer	103066	1



Measuring relay technology

Under-/over-voltage relay

230/400V AC

- ✓ 3-phase monitoring for under-voltage, over-voltage, phase release and phase sequence
- ✓ N conductor monitoring
- ✓ Construction width 17.8mm (1 unit)
- ✓ Under-/over-voltage adjustable
- ✓ Power consumption under 1W
- ✓ LED error display
- ✓ For 1-phase applications, Comfort connection L/N integrated (time-consuming bridging of the conductors L1, L2 and L3 is no longer necessary)

Item	Item no.	PU
Under-/over-voltage relay AC adjustable, 2 changer	103067	1



Under-/over-voltage relay DC

- ✓ Under-/over-voltage monitoring for DC
- ✓ Selectable voltage ranges: 24V/60V/110V/220V DC
- ✓ Construction width 17.8mm (1 unit)
- ✓ Under-/over-voltage adjustable
- ✓ Power consumption under 1W
- ✓ LED error display for under-/over-voltage

Item	Item no.	PU
Under-/over-voltage relay 24/60/110/220V DC adjustable, 2 changer	103068	1



Phase indicator

- ✓ Display of all 3 phases by green LED (phase against N)
- ✓ LED display at L1 for DC (L1+/N-)
- ✓ Construction width 17.8mm (1 unit)
- ✓ Power consumption under 1W
- ✓ Voltage range 85 – 690V AC/DC

Item	Item no.	PU
Phase indicator	103009	1



Mains monitoring measurement relay

- ✓ Adjustable overvoltage/ undervoltage monitoring
- ✓ Adjustable switching hysteresis
- ✓ Adjustable frequency monitoring (AC)
- ✓ Adjustable asymmetry (AC)
- ✓ Adjustable mains form/ operating voltage
- ✓ Adjustable time delay
- ✓ 2 changer contacts (individually adjustable)
- ✓ Operating and display via graphic display

Item	Item no.	PU
Mains monitoring relay	103040	1
DC mains monitoring relay	103041	1



Measuring relay technology



KE-P80 Modbus

Digital measuring devices, current transformers & accessories



Due to the increasing demand for energy optimization and the introduction of energy management systems in accordance with ISO 50001 - digital measurement technology is becoming more and more important. With our space-saving MID-certified electricity meters from the KE series you always have a precise overview of your system values and always have the option of retrofitting bus communication. Also for compact and K'ELECTRIC also offers you innovative solutions for compact and contact-protected current transformers.

P-series electricity meter

with MID certification

- ✓ Digital single-phase alternating current meter up to 40A direct measurement in 1 unit
- ✓ Digital three-phase meter up to 80A Direct measurement in 4 units
- ✓ Digital three-phase meter up to 125A Direct measurement in 6 units
- ✓ Digital three-phase current transformer meter for 5 A / 1 A in 4 units
- ✓ Display: Active and reactive energy, instantaneous active and reactive power (consumption and supply)
- ✓ Possible display of all relevant measurement data (UI / II/ PF / F / THD in %) of the individual phases
- ✓ With adjustable transformer ratio (can be changed indefinitely)
- ✓ Double tariff meter HT / NT (T1 / T2) with tariff switching input
- ✓ S0 output for active and reactive energy
- ✓ Optional extension through communication modules: KNX, M-Bus, MOD-Bus, LAN, eVision
- ✓ Accuracy: active energy B (class 1)
- ✓ Made in EU: with EU-wide MID-certification

Alternating current meter

Item	Item no.	PU
KE-P40 MID S0	195851	1
KE-P40 MID with M-BUS	195852	1
KE-P40 MID with Modbus	195853	1



195852

Direct current meter

Item	Item no.	PU
KE-P80 MID S0	195831	1
KE-P80 MID M-BUS	195832	1
KE-P80 MID MOD-BUS	195833	1
KE-N125 MID, 6 units construction width	195552	1



195831

Transformer meter

Item	Item no.	PU
KE-P/5 MID S0	195841	1
KE-P/5 MID M-BUS	195842	1
KE-P/5 MID MOD-BUS	195843	1



195841

Communication modules

Item	Item no.	PU
M-Bus module	195580	1
MOD-Bus module	195581	1
LAN module	195582	1
KNX module	195583	1
eVision module with embedded web app	195586	1



195583



195586

LAN server MOD-Bus / TCP data concentrator

All data can be transmitted via Ethernet/WLAN using an http interface via a web browser. Device connection via Mod-Bus (RTU). The software is included in the unit.

- ✓ The data transmission takes place via the TCP / IP protocol
- ✓ Maximum 31 measuring devices via MODbus
- ✓ The built-in memory is 2 gigabytes
- ✓ Only 4 units width (72mm)

Item	Item no.	PU
LAN server MOD-Bus	195701	1



Multifunction meter **Krypton E3**

- ✓ 3 Ø voltage (TRMS)
- ✓ 3 Ø current (TRMS)
- ✓ Operating hours counter
- ✓ Programmable current/voltage transformer (only primary)
- ✓ Additional bargraph display for current in %
- ✓ Speed

Item	Item no.	PU
Multifunction meter Krypton E3	220009	1



220009

Multifunction meter **Krypton E5**

- ✓ 3 Ø voltage (TRMS)
- ✓ 3 Ø current (TRMS)
- ✓ 3 Ø power factor
- ✓ 3 Ø active power, reactive power, apparent power
- ✓ Active energy
- ✓ Frequency
- ✓ Programmable current/voltage transformer
- ✓ With pulse output
- ✓ Distortion factor

Item	Item no.	PU
Multifunction meter Krypton E5	220000	1



220000

Multifunction meter **Krypton E10**

- ✓ 3 Ø voltage (TRMS)
- ✓ 3 Ø current (TRMS)
- ✓ 3 Ø power factor
- ✓ 3 Ø active power, reactive power, apparent power
- ✓ Active energy, reactive energy, apparent energy
- ✓ Frequency
- ✓ Programmable current/voltage transformer
- ✓ Distortion factor
- ✓ Additional bargraph display for current in %
- ✓ With Modbus RTU (RS485) and S0 interface
- ✓ Pulse output

Item	Item no.	PU
Multifunction meter Krypton E10	220001	1



220001

Multifunction meter **Krypton H10**

- ✓ 3 Ø voltage (TRMS)
- ✓ 3 Ø current (TRMS)
- ✓ 3 Ø power factor
- ✓ 3 Ø active power, reactive power, apparent power
- ✓ Active energy, reactive energy, apparent energy
- ✓ Frequency
- ✓ Programmable current/voltage transformer
- ✓ With Modbus RTU (RS485) and S0 interface

Item	Item no.	PU
Multifunction meter Krypton H10	220200	1



220200

Plug-in current transformer

Overview of the types

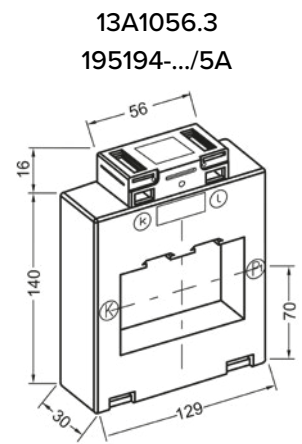
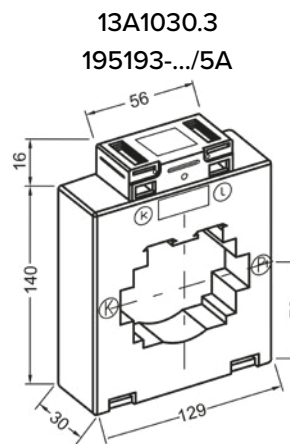
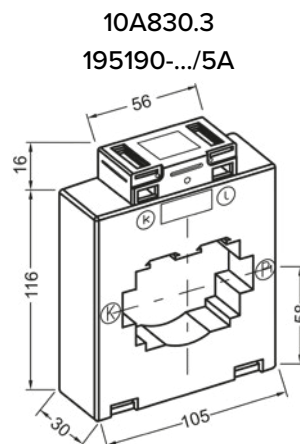
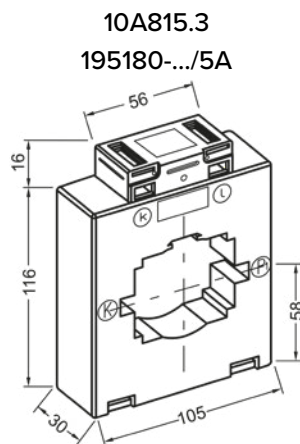
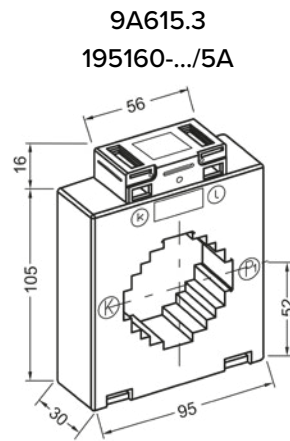
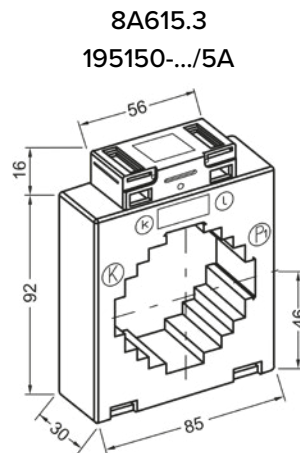
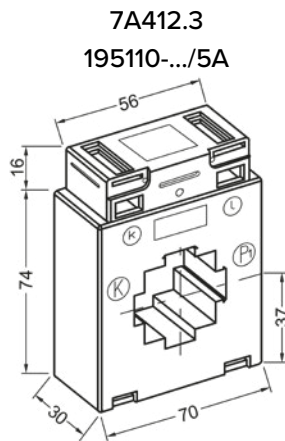
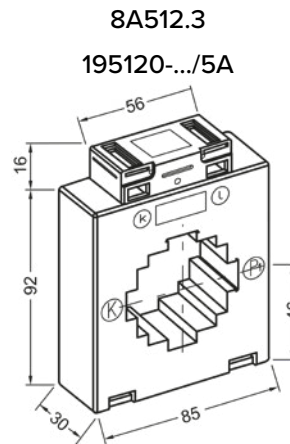
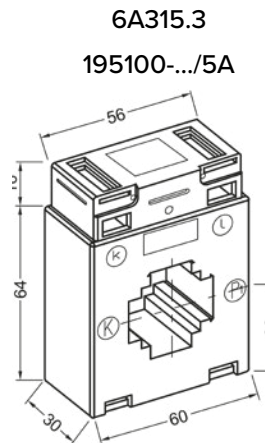
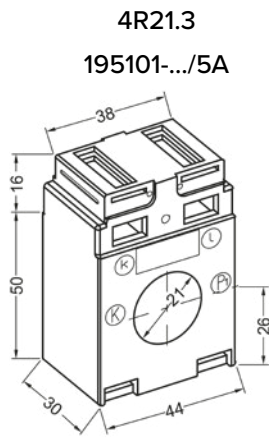

Plug-in current transformer

Plug-in current transformer (Class 1)

Item	Rated current in A	Item no.	PU
Current transformer 4R21.3	100, 125, 150, 200, 250, 300, 400, 500	195101-.../5A	1
Current transformer 6A315.3	75, 80, 100, 125, 150, 200, 250, 300, 400, 500, 600, 750	195100-.../5A	1
Current transformer 7A412.3	100, 125, 150, 200, 250, 300, 400, 500, 600, 750, 800, 1000	195110-.../5A	1
Current transformer 8A512.3	150, 200, 250, 300, 400, 500, 600, 750, 800, 1000, 1250, 1500	195120-.../5A	1
Current transformer 8A615.3	200, 250, 300, 400, 500, 600, 750, 800, 1000, 1250, 1500, 1600	195150-.../5A	1
Current transformer 9A615.3	200, 250, 300, 400, 500, 600, 750, 800, 1000, 1250, 1500, 1600, 2000, 2500	195160-.../5A	1
Current transformer 10A815.3	400, 500, 600, 750, 800, 1000, 1250, 1500, 1600, 2000, 2500	195180-.../5A	1
Current transformer 10A830.3	400, 500, 600, 750, 800, 1000, 1250, 1500, 1600, 2000, 2500	195190-.../5A	1
Current transformer 13A1030.3	400, 500, 600, 750, 800, 1000, 1250, 1500, 1600, 2000, 2500, 3000, 4000	195193-.../5A	1
Current transformer 13A1056.3	500, 600, 750, 800, 1000, 1250, 1500, 1600, 2000, 2500, 3000, 4000	195194-.../5A	1



195101-50/5A



195110-125/5A

Accessories

Item	Item no.	PU
Snap-on mounting for rails (1 pair)	195140	1
Insulating caps for fixing screws (1 pair)	195141	1
Plug-in foot plastic (1 pair)	195142	1



195141



195142

Clearing transformer (Class 0.5) incl. certificate of conformity

Item	Rated current in A	Item no.	PU
Clearing transformer E4R21.3	100, 125, 150, 200, 250, 300, 400, 500	195135-.../5A	1
Clearing transformer E6A315.3	150, 200, 250, 300, 400, 500, 600, 750	195130-.../5A	1
Clearing transformer E7A412.3	150, 200, 250, 300, 400, 500, 600, 750, 800, 1000	195131-.../5A	1
Clearing transformer E8A512.3	150, 200, 250, 300, 400, 500, 600, 750, 800, 1000, 1250, 1500	195132-.../5A	1
Clearing transformer E8A615.3	250, 300, 400, 500, 600, 750, 800, 1000, 1250	195133-.../5A	1
Clearing transformer E9A615.3	200, 250, 300, 400, 500, 600, 750, 800, 1000, 1250, 1500, 1600, 2000	195134-.../5A	1
Clearing transformer E10A815.3	400, 500, 600, 750, 800, 1000, 1250, 1500	195136-.../5A	1



195131-400/5A

Conversion current transformer

Folding transformer (Class 1)

Cable culvert 24mm

Item	Item no.	PU
Conversion current transformer 100/5A culvert 24mm	195320-100A	1
Conversion current transformer 150/5A culvert 24mm	195320-150A	1
Conversion current transformer 200/5A culvert 24mm	195320-200A	1
Conversion current transformer 250/5A culvert 24mm	195320-250A	1
Conversion current transformer 300/5A culvert 24mm	195320-300A	1
Conversion current transformer 400/5A culvert 24mm	195320-400A	1



Cable culvert 36mm

Item	Item no.	PU
Conversion current transformer 100/5A culvert 36mm	195321-100A	1
Conversion current transformer 300/5A culvert 36mm	195321-300A	1
Conversion current transformer 500/5A culvert 36mm	195321-500A	1
Conversion current transformer 600/5A culvert 36mm	195321-600A	1



Other types and accuracy classes on request.

Three-phase compact current transformer

- ✓ Hole center distance 60mm
- ✓ For rail thicknesses from 12x5–30x10mm
- ✓ Construction width 48.5mm
- ✓ Spring terminals 4mm²
- ✓ All-round touch protection of the busbars
- ✓ Can be used flexibly in the installation distributor and on a mounting plate

Item	Item no.	PU
Three-phase current transformer, primary current 100A, 60mm busbar, Class 1; 1VA	223013-100/5A	1
Three-phase current transformer, primary current 150A, 60mm busbar, Class 1; 1.5VA	223013-150/5A	1
Three-phase current transformer, primary current 200A, 60mm busbar, Class 1; 2.5VA	223013-200/5A	1
Three-phase current transformer, primary current 250A, 60mm busbar, Class 1; 2.5VA	223013-250/5A	1
Three-phase current transformer, primary current 400A, 60mm busbar, Class 1; 3.75VA	223013-400/5A	1
Three-phase current transformer, primary current 600A, 60mm busbar, Class 1; 5VA	223013-600/5A	1
Three-phase current transformer, primary current 630A, 60mm busbar, Class 1; 5VA	223013-630/5A	1



Plug'n-wire-multifunction meter **Krypton E20**

- ✓ 3 Ø current (TRMS) | 3 Ø voltage (TRMS)
- ✓ 3 Ø power factor
- ✓ 3 Ø active power, reactive power, apparent power
- ✓ Frequency
- ✓ Distortion factor
- ✓ Additional bar graph display (current) in %
- ✓ Programmable current/voltage transformer
- ✓ 4-line LCD display with light
- ✓ Up to 32 units can be connected thanks to voltage sockets
- ✓ With Modbus RTU (RS485) and S0 interface

Item	Item no.	PU
Multifunction meter Krypton E20	220002	1



Plug'n-wire-multifunction meter **Krypton H20**

- ✓ 3 Ø current (TRMS) | 3 Ø voltage (TRMS)
- ✓ 3 Ø power factor
- ✓ 3 Ø active power, reactive power, apparent power
- ✓ Frequency
- ✓ Distortion factor
- ✓ Programmable current/voltage transformer
- ✓ 4-line LCD display with light
- ✓ Up to 32 units can be connected thanks to voltage sockets
- ✓ With Modbus RTU (RS485) and S0 interface

Item	Item no.	PU
Multifunction meter Krypton H20	220201	1

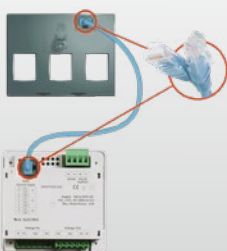

Save time and money!

The unique concept reduces the wiring and installation time of multifunctional measuring devices and current transformers drastically.



Three-phase current transformer for the Plug'n-wire system

The three-phase current transformer has been developed for use with the Plug'n-Wire system. The integrated protective circuit automatically limits the output voltage to a safe level. This means that the current transformer can also be operated in no-load mode on the secondary side under load.

Item	Rated current in A	Item no.	PU
3-phase current transformer, hole center distance 35mm	60 / 100 / 125 / 160 / 200 / 250	220010-...A	1
3-phase current transformer, hole center distance 45mm	250 / 400 / 600 / 630	220011-...A	1
3-phase current transformer, hole center distance 75mm	800 / 1000 / 1250 / 1600	220012-...A	1
3-phase current transformer for the busbar 60mm, hole center distance 60mm	100 / 150 / 200 / 250 / 400 / 600 / 630	220013-...A	1



Accessories

Item	Item no.	PU
RJ45 connection cable 1.5m	220101	1
RJ45 connection cable 2m	220102	1
RJ45 connection cable 2m flat	220102-F	1
RJ45 connection cable 3m	220103	1
RJ45 connection cable 5m	220105	1
RJ45 connection cable 10m	220106	1



Your advantages:

- ✔ considerable savings in working time
- ✔ elimination of wiring errors
- ✔ increased safety
- ✔ choice of different three-phase current transformer
- ✔ no need for test disconnect terminals
- ✔ reduced test times
- ✔ fully EMV-tested and CE-certified

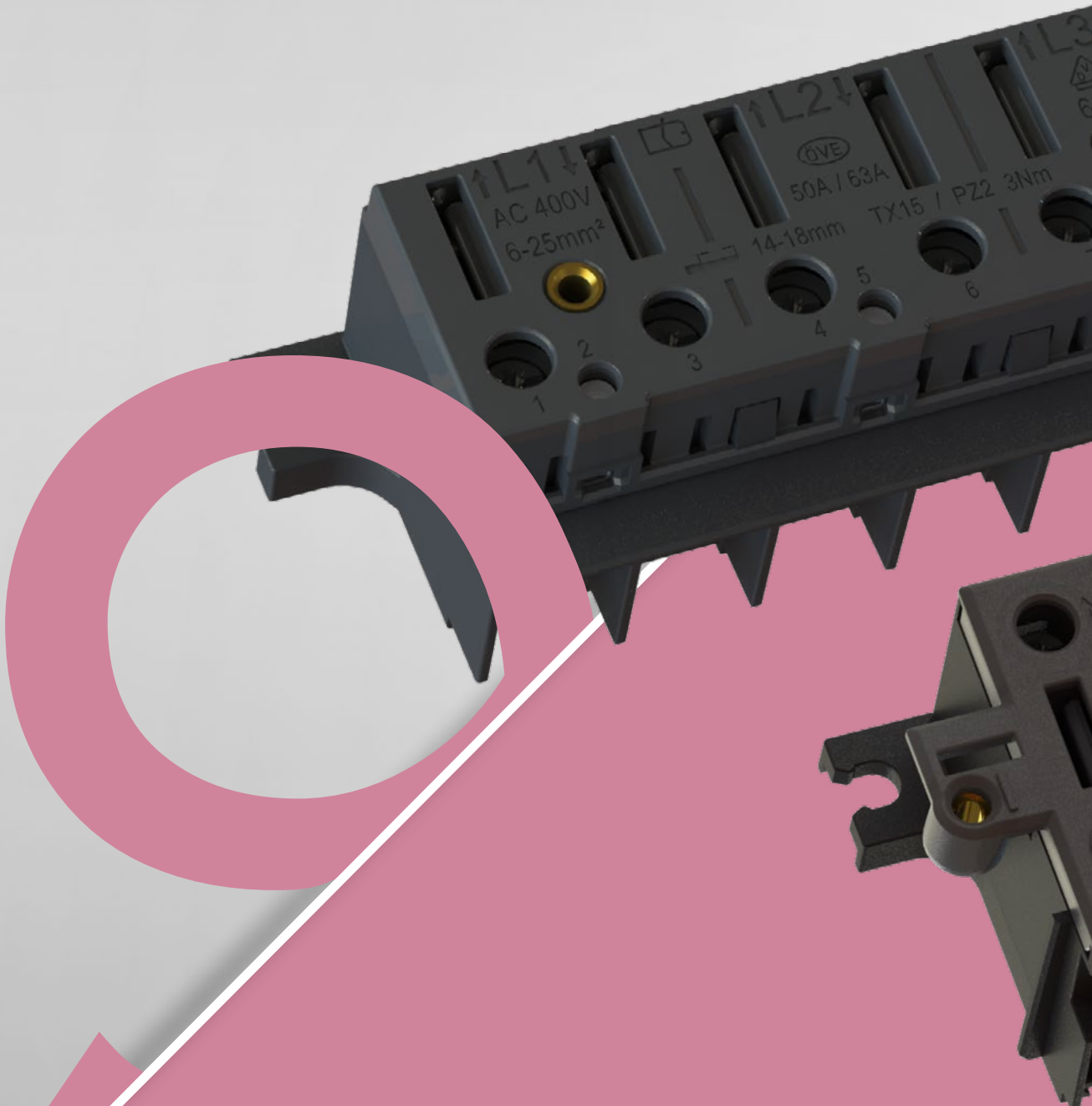

ADOCK®
Plug-in meter terminals

Plug-in meter terminals for 63A and 100A

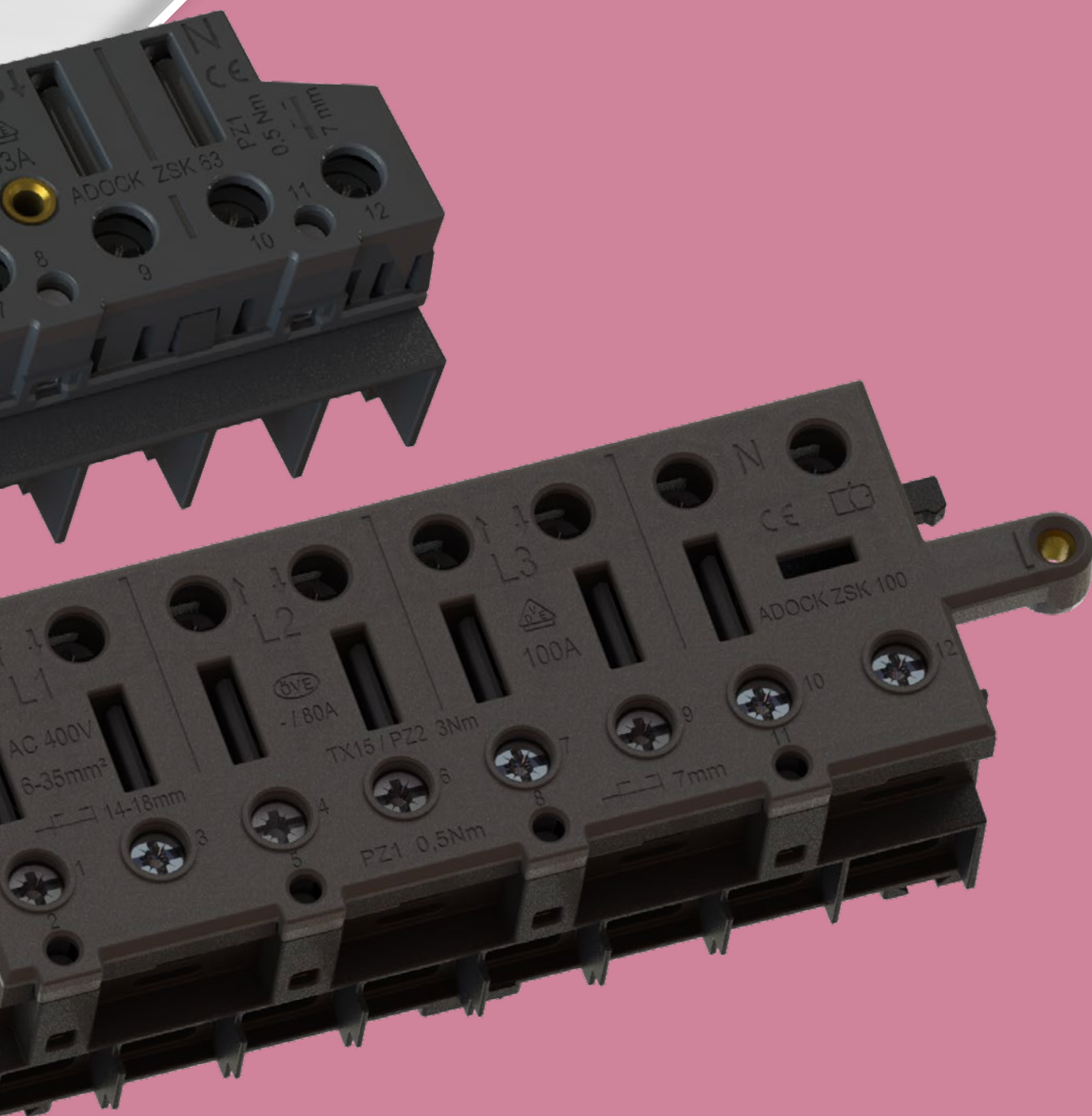

Plug-in meter terminals enable the quick replacement of kWh meters without interrupting the operating voltage of downstream systems. With the ADOCK® series, we offer you the optimum solution here.

ADOCK®

Plug-in meter terminal 63A

For the quick and safe replacement of electronic electricity meters.

- ✓ For electricity meters to DIN 43857 with 3-point mounting
- ✓ Powerless meter installation with time savings of up to 80%
- ✓ Uninterrupted meter replacement for high flexibility and customer satisfaction
- ✓ Simple locking function and sealing
- ✓ Counter pins in the magazine as a mounting aid for quick and contactless mounting
- ✓ Compact design with universal screws for easy installation
- ✓ Optional TRE connection terminals for ripple control receivers
- ✓ Universal terminal screws for Phillips, slotted and Torx bit inserts

Accessories:

- ✓ ADOCK system pins: highly conductive E-alloy, silver-plated in the magazine
- ✓ ADOCK bracket: for effortless and uninterrupted meter replacement
- ✓ ADOCK cover: for securely covering and sealing the terminal

Plug-in meter terminal 63A

Item	Item no.	PU
Plug-in meter terminal 63A	101021	1
Plug-in meter terminal 63A with TRE connection terminals	101022	1
Plug-in meter terminal 63A in set with system pins (40mm) in magazine	101021-M	1
Plug-in meter terminal 63A with TRE connection terminals in set with system pins (40mm) in magazine	101022-M	1
AC plug-in meter terminal	101002	1



Accessories – Plug-in meter terminal 63A

System pins	Item no.	PU
System pins 40mm in magazine	101011	1
System pins 44mm in magazine	101011-44	1



Bracket	Item no.	PU
Three-phase ADOCK bracket, 4-pole (3P+N), 400V AC	101008	1

Delivery only to energy suppliers/ municipal and public utilities/ metering point operators.

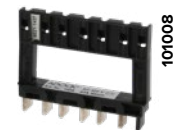

Cover	Item no.	PU
Cover for three-phase plug-in meter terminal	101025	2



ADOCK® Plug-in meter terminal 100A

For the quick and safe replacement of electronic electricity meters.

- ✓ For electricity meters to DIN 43857 with 3-point mounting
- ✓ Powerless and time-saving meter installation
- ✓ Uninterrupted meter replacement for high flexibility and customer satisfaction
- ✓ Simple locking function and sealing
- ✓ Counter pins in the magazine as a mounting aid for quick and contactless mounting
- ✓ Compact design with universal screws for easy installation
- ✓ Optional TRE connection terminals for ripple control receivers
- ✓ Universal terminal screws for Phillips, slotted and Torx bit inserts

Accessories:

- ✓ ADOCK system pins: highly conductive E-alloy, silver-plated in the magazine
- ✓ ADOCK bracket: for effortless and uninterrupted meter replacement
- ✓ ADOCK cover: for securely covering and sealing the terminal

Plug-in meter terminal 100A

Item	Item no.	PU
Plug-in meter terminal 100A in a set with system pins in a magazine	101026-M	1
Plug-in meter terminal 100A with TRE connection terminals in a set with system pins in the magazine	101027-M	1
Plug-in meter terminal 100A incl. mounted system pins	101026-S	n.a.
Plug-in meter terminal 100A with TRE connection terminals incl. mounted system pins	101027-S	n.a.



Accessories – Plug-in meter terminal 100A

System pins	Item no.	PU
System pins 40mm in magazine (D=6.2mm)	101030	1



Bracket	Item no.	PU
Three-phase ADOCK bracket, 4-pole (3P+N), 400V AC	101008	1

Delivery only to energy suppliers/ municipal and public utilities/ metering point operators.

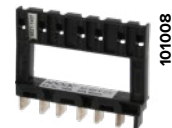

Cover	Item no.	PU
Cover for three-phase plug-in meter terminal	101014	2



Plug-in meter terminals



Wiring rails

Wiring rails & Accessories

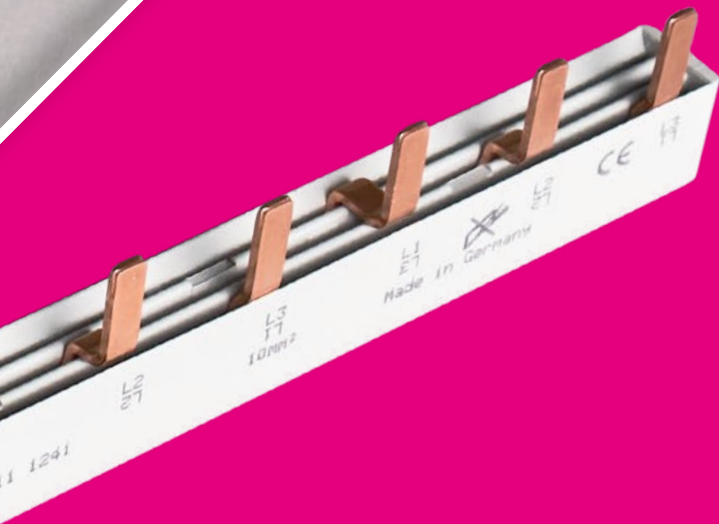

To save you time and ensure system reliability we offer you a wide range of suitable wiring rails for our D0 switchgear and common common LS and RCD combinations.

Pin – Wiring rails

for double terminal/ frame terminal

LS switch | FI switch | LS and FI switch
 e.g. **ABB, Siemens, Schneider**
ABB = Module width 17.6mm
 Please note for **56 units** and **57 units**.

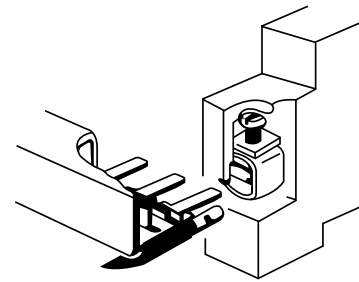

1-pole pin wiring rails

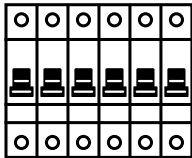

L1 ...

Item	Item no.	FN*	Cross section	End cap	PU
Pin, 1-pole, 90° curved, iso, 1.00m, 17.6mm	111328	57	10mm ²	171001	25
Pin, 1-pole, 90° curved, iso, 1.00m	111329	57	10mm ²	171001	25
Pin, 1-pole, 90° curved, iso, 1.00m, 17.6mm	111338	57	16mm ²	171001	25
Pin, 1-pole, 90° curved, iso, 1.00m	111339	57	16mm ²	171001	25



1-pole pin wiring rails | for HI switch

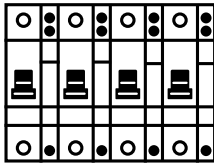

Item	Item no.	FN*	Cross section	End cap	PU
Pin, 1-pole, 90° curved, 27mm, 1.00m	111071	37	16mm ²	171001	25
Pin, 1-pole, 90° curved, 27mm	111271	8	16mm ²	✓	10
Pin, 1-pole, 90° curved, 27mm, 1.00m	102021	37	25mm ²	171005	10
Pin, 1-pole, 90° curved, 27mm, 1.00m	102031	37	35mm ²	171005	10

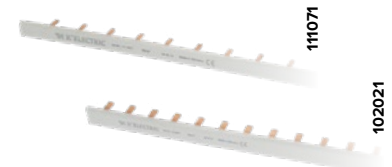

2-pole pin wiring rails

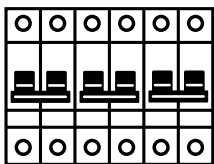

L1 L2 L1 L2 L1 L2 ...

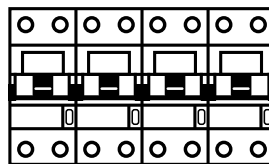

L1 N L1 N L1 N L1 N ...

Item	Item no.	FN*	Cross section	End cap	PU
Pin, 2-pole, 1.00m, 17.6mm	111325	56	10mm ²	171002	20
Pin, 2-pole, 12 units	111324	12	10mm ²	✓	10
Pin, 2-pole 1.00m, 17.8mm	111351	56	10mm ²	171002	20
Pin, 2-pole, 1.00m, 17.6mm	111327	56	16mm ²	171007	20
Pin, 2-pole, 12 units	111326	12	16mm ²	✓	10



*FN = Number of flags

2-pole pin wiring rails | with HI switch

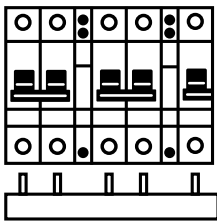

L1 L2 L1 L2 ...

Item	Item no.	FN*	Cross section	End cap	PU
Pin, 2-pole + 9mm, 1.00m	11077	38	16mm ²	171007	20

3-pole pin wiring rails

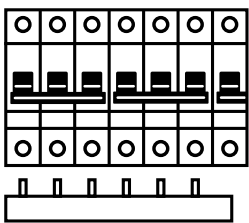

L1 L2 L3 L1 L2 L3 ...

Item	Item no.	FN*	Cross section	End cap	PU
Pin, 3-pole, 1.00m	11042	57	10mm ²	171003	20
Pin, 3-pole, 1.00m, 17.6mm	11040	57	10mm ²	171003	20
Pin, 3-pole, 6 units	11248	6	10mm ²	✓	10
Pin, 3-pole, 7 units	11293	7	10mm ²	✓	10
Pin, 3-pole, 8 units	11292	8	10mm ²	✓	10
Pin, 3-pole, 9 units	11247	9	10mm ²	✓	10
Pin, 3-pole, 12 units	11246	12	10mm ²	✓	10
Pin, 3-pole, 1.00m, 17.6mm	11301	57	16mm ²	171007	20
Pin, 3-pole, 1.00m	11370	57	16mm ²	171007	20
Pin, 3-pole, 5 units	11278	5	16mm ²	✓	10
Pin, 3-pole, 6 units	11279	6	16mm ²	✓	10
Pin, 3-pole, 7 units	11280	7	16mm ²	✓	10
Pin, 3-pole, 8 units	11281	8	16mm ²	✓	10
Pin, 3-pole, 9 units	11284	9	16mm ²	✓	10
Pin, 3-pole, 10 units	11289	10	16mm ²	✓	10
Pin, 3-pole, 11 units	11291	11	16mm ²	✓	10
Pin, 3-pole, 12 units	11300	12	16mm ²	✓	10
Pin, 3-pole, 1.00m	11348	57	25mm ²	171006	5



*FN = Number of flags

3-pole pin wiring rails | for FI and LS switch

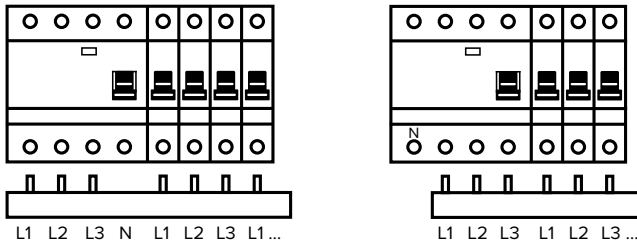

Item	Item no.	FN*	Cross section	End cap	PU
Pin, 3-pole, 4.pol.FI (N right) + 8xLS, 12 units	111250	11	10mm ²	✓	10
Pin, 3-pole, 4.pol.FI (N right) + 6xLS, 10 units	111264	9	10mm ²	✓	10
Pin, 3-pole, 4.pol.FI (N right) + 5xLS, 9 units	111266	8	10mm ²	✓	10
Pin, 3-pole, 4.pol.FI (N right) + 3xLS, 7 units	111273	6	10mm ²	✓	10
Pin, 3-pole, 4.pol.FI (N left) + 8xLS, 11 units	111310	11	10mm ²	✓	10
Pin, 3-pole, 4.pol.FI (N left) + 6xLS, 9 units	111247	9	10mm ²	✓	10
Pin, 3-pole, 4.pol.FI (N left) + 8xLS, 11 units	111291	11	16mm ²	✓	10
Pin, 3-pole, 4.pol.FI (N left) + 6xLS, 9 units	111284	9	16mm ²	✓	10
Pin, 3-pole, 4.pol.FI (N right) + 8xLS, 12 units	111305	11	16mm ²	✓	10
Pin, 3-pole, 4.pol.FI (N right) + 6xLS, 10 units	111349	9	16mm ²	✓	10



3-pole pin wiring rails | with HI switch

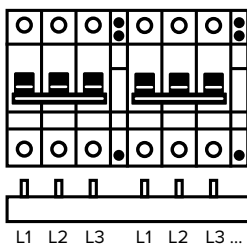

Item	Item no.	FN*	Cross section	End cap	PU
Pin, 3-pole + 9mm, 1.00m, 17.6mm	111354	48	10mm ²	171003	10
Pin, 3-pole + 9mm	111359	12	16mm ²	✓	10
Pin, 3-pole + 9mm	111358	9	16mm ²	✓	10
Pin, 3-pole + 9mm, 1.00m	111357	48	25mm ²	171006	5



*FN = Number of flags

3-pole pin wiring rails | with HI switch after each pole

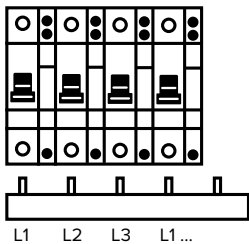

Item	Item no.	FN*	Cross section	End cap	PU
Pin, 3-pole, 27mm, 1.00m	111073	36	16mm ²	171007	20
Pin, 3-pole, 27mm	111275	6	16mm ²	✓	10
Pin, 3-pole, 27mm	111276	9	16mm ²	✓	10
Pin, 3-pole, 27mm	111277	12	16mm ²	✓	20
Pin, 3-pole, 27mm, 1.00m	102023	36	25mm ²	171006	5
Pin, 3-pole, 27mm	111285	6	25mm ²	✓	5
Pin, 3-pole, 27mm	111286	9	25mm ²	✓	5
Pin, 3-pole, 27mm	111287	12	25mm ²	✓	5
Pin, 3-pole, 27mm, 1.00m	102033	36	35mm ²	171006	5

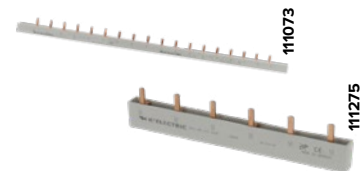

4-pole pin wiring rails

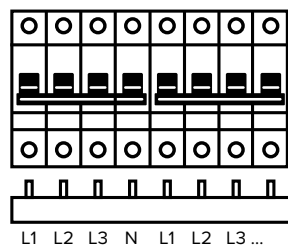
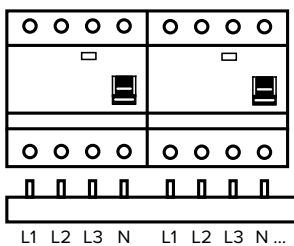

Item	Item no.	FN*	Cross section	End cap	PU
Pin, 4-pole, 1.00m, 17.6mm	111313	56	10mm ²	171004	15
Pin, 4-pole, 1.00m	111353	56	10mm ²	171004	15
Pin, 4-pole, 8 units	111347	8	10mm ²	✓	5
Pin, 4-pole, 12 units	111312	12	10mm ²	✓	5
Pin, 4-pole, 12 units, N left	111395	12	10mm ²	✓	5
Pin, 4-pole, 1.00m, 17.6mm	111315	56	16mm ²	171004	15
Pin, 4-pole, 1.00m	111342	56	16mm ²	171004	15
Pin, 4-pole, 8 units	111299	8	16mm ²	✓	5
Pin, 4-pole, 12 units	111314	12	16mm ²	✓	5

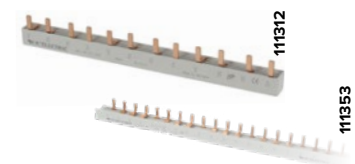

*FN = Number of flags

4-pole pin wiring rails | with HI switch

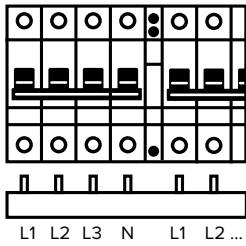

Item	Item no.	FN*	Cross section	End cap	PU
Pin, 4-pole + 9mm, 1,00m, 17,6mm	111355	48	16mm ²	171004	15



4-pole pin wiring rails | L1,N,L2,N,L3,N | N,L1,N,L2,N,L3

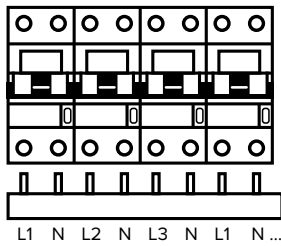

Item	Item no.	FN*	Cross section	End cap	PU
Pin, 4-pole, L1,N,L2,N,L3,N, 1,00m, 17,6mm	111318	54	10mm ²	171004	15
Pin, 4-pole, L1,N,L2,N,L3,N, 1,00m	111352	54	10mm ²	171004	15
Pin, 4-pole, L1,N,L2,N,L3,N, 12 units	111255	12	10mm ²	✓	5
Pin, 4-pole, L1,N,L2,N,L3,N, 1,00m, 17,6mm	111330	54	16mm ²	171004	15
Pin, 4-pole, L1,N,L2,N,L3,N, 1,00m	111334	54	16mm ²	171004	15
Pin, 4-pole, L1,N,L2,N,L3,N, 12 units	111256	12	16mm ²	✓	5
Pin, 4-pole, N,L1,N,L2,N,L3, 1,00m, N left	111363	54	16mm ²	171004	15
Pin, 4-pole, N,L1,N,L2,N,L3, 12 units, N left	111364	12	16mm ²	✓	5

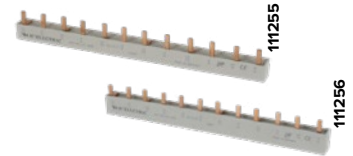

4-pole pin wiring rails | L1,N+HI, L2,N+HI, L3,N+HI

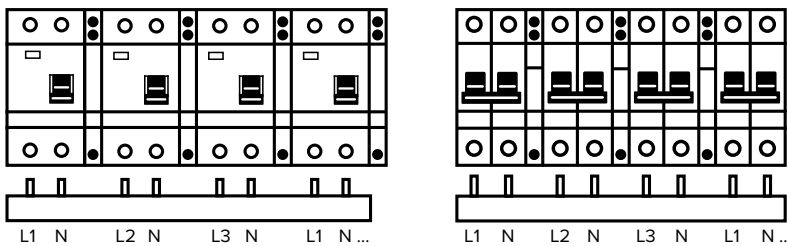

Item	Item no.	FN*	Cross section	End cap	PU
Pin, 4-pole, L1,N+9mm, L2,N+9mm, L3,N+9mm, 1,00m	111356	44	16mm ²	171004	15



*FN = Number of flags

Pin – Wiring rails

for double terminal/ frame terminal, 27mm

**D0 switch-disconnector Coron DUO | D0 switch-disconnector TYTAN II |
D0 switch-disconnector Coron II | D0 fuse base E14 & E18**



1-pole pin wiring rails

Item	Item no.	FN*	Cross section	End cap	PU
Pin, 1-pole, 27mm, 90° curved, iso, 1.00m	111071	37	16mm ²	171001	25
Pin, 1-pole, 27mm, iso	111271	8	16mm ²	✓	10
Pin, 1-pole, 27mm, 90° curved, iso, 1.00m	102021	37	25mm ²	171005	10
Steg, 1-polig, 27mm, 90° curved, iso, 1.00m	102031	37	35mm ²	171005	10

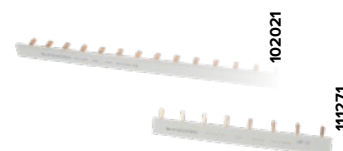

2-pole pin wiring rails

Item	Item no.	FN*	Cross section	End cap	PU
Pin, 2-pole, 27mm, 1.00m	111072	36	16mm ²	171001	20
Pin, 2-pole, 27mm	111272	8	16mm ²	✓	10
Pin, 2-pole, 27mm, 1.00m	102022	36	25mm ²	171006	5
Pin, 2-pole, 27mm	111282	8	25mm ²	✓	5
Pin, 2-pole, 27mm, 1.00m	102032	36	35mm ²	171006	5



3-pole pin wiring rails

Item	Item no.	FN*	Cross section	End cap	PU
Pin, 3-pole, 27mm, 1.00m	111073	36	16mm ²	171007	20
Pin, 3-pole, 27mm	111275	6	16mm ²	✓	10
Pin, 3-pole, 27mm	111276	9	16mm ²	✓	10
Pin, 3-pole, 27mm	111277	12	16mm ²	✓	10
Pin, 3-pole, 27mm, 1.00m	102023	36	25mm ²	171006	5
Pin, 3-pole, 27mm	111285	6	25mm ²	✓	5
Pin, 3-pole, 27mm	111286	9	25mm ²	✓	5
Pin, 3-pole, 27mm	111287	12	25mm ²	✓	5
Pin, 3-pole, 27mm, 1.00m	102033	36	35mm ²	171006	5

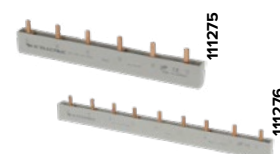

4-pole pin wiring rails

Item	Item no.	FN*	Cross section	End cap	PU
Pin, 4-pole, 27mm, 1.00m	111074	36	16mm ²	171004	15
Pin, 4-pole, 27mm, 1.00m	102034	36	35mm ²	171006 171005	5



*FN = Number of flags

Pin – Wiring rails

for double terminal/ frame terminal

TYTAN Q



2-pole pin wiring rails

Item	Item no.	FN*	Cross section	End cap	PU
Pin, 2-pole, 1.00m	111325	56	10mm ²	171002	20
Pin, 2-pole, 12 units	111324	12	10mm ²	✓	10



Pin, 2-pole, 1.00m	111327	56	16mm ²	171007	20
Pin, 2-pole, 12 units	111326	12	16mm ²	✓	10

3-pole pin wiring rails

Item	Item no.	FN*	Cross section	End cap	PU
Pin, 3-pole + 17.8mm, 1.00m	111368	42	16mm ²	171007	20
Pin, 3-pole + 17.8mm (2x3-pol)	111294	6	16mm ²	✓	10
Pin, 3-pole + 17.8mm (3x3-pol)	111295	9	16mm ²	✓	10

Pin, 3-pole + 17.8mm, 42 units	111366	42	35mm ²	171006	5
Pin, 3-pole + 17.8mm (2x3-pol)	111296	9	35mm ²	✓	5

4-pole pin wiring rails

Item	Item no.	FN*	Cross section	End cap	PU
Pin, 4-pole, 1.00m	111353	56	10mm ²	171004	15
Pin, 4-pole, 12 units	111312	12	10mm ²	✓	5
Pin, 4-pole, 8 units	111347	8	10mm ²	✓	5

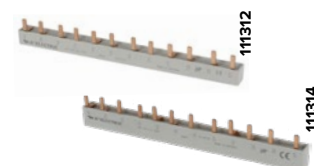

Pin, 4-pole, 1.00m	111342	56	16mm ²	171004	15
Pin, 4-pole, 12 units	111314	12	16mm ²	✓	5
Pin, 4-pole, 8 units	111299	8	16mm ²	✓	5

4-pole pin wiring rails

Item	Item no.	FN*	Cross section	End cap	PU
Pin, 4-pole, L1,N,L2,N,L3,N, 1.00m	111330	54	16mm ²	171004	15
Pin, 4-pole, L1,N,L2,N,L3,N, 12 units	111256	12	16mm ²	✓	5



*FN = Number of flags

Fork – Wiring rails

for screw terminal with terminal clamp

LS switch | FI switch | LS and FI switch | TYTAN I
e.g. Hager, GE, AEG, Legrand, Eaton, Doepke, ETI

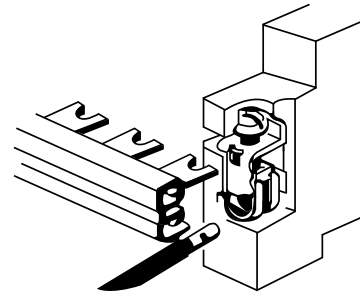

1-pole fork wiring rails

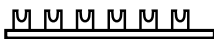
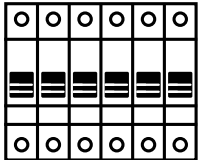

L1 ...

Item	Item no.	FN*	Cross section	End cap	PU
Fork, 1-pole, 90° curved, iso, 1.00m	111061	57	16mm ²	171001	25
Fork, 1-pole, iso, 12 units	111261	12	16mm ²	✓	10



1-pole fork wiring rails | for HI switch

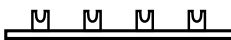
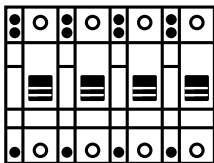

L ...

Item	Item no.	FN*	Cross section	End cap	PU
Fork, 1-pole, 27mm, 90° curved, iso, 1.00m	111345	37	16mm ²	171001	25

2-pole fork wiring rails

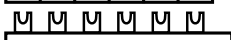
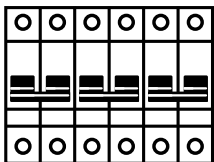

L1 L2 L1 L2 L1 L2 ...

Item	Item no.	FN*	Cross section	End cap	PU
Fork, 2-pole, 1.00m	111062	56	16mm ²	171007	20
Fork, 2-pole, 12 units	111262	12	16mm ²	✓	10

*FN = Number of flags

3-pole fork wiring rails

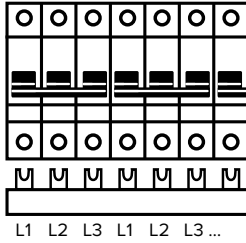

Item	Item no.	FN*	Cross section	End cap	PU
Fork, 3-pole, 1,00m	111041	57	10mm ²	171003	20
Fork, 3-pole, 12 units	111243	12	10mm ²	✓	10
Fork, 3-pole, 9 units	111244	9	10mm ²	✓	10
Fork, 3-pole, 6 units	111245	6	10mm ²	✓	10
Fork, 3-pole, 1,00m	111063	57	16mm ²	171007	20
Fork, 3-pole, 12 units	111263	12	16mm ²	✓	10

3-pole fork wiring rails | for FI and LS switch

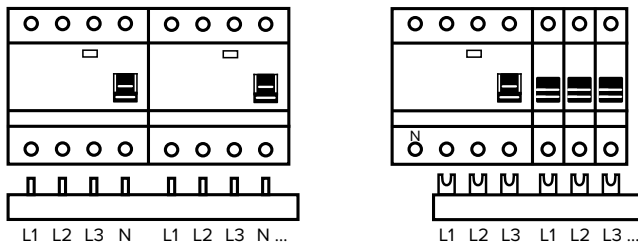

Item	Item no.	FN*	Cross section	End cap	PU
Fork, 3-pole, 4.pol.FI (N right) + 8xLS, 12 units	111251	11	10mm ²	✓	10
Fork, 3-pole, 4.pol.FI (N right) + 6xLS, 10 units	111265	9	10mm ²	✓	10
Fork, 3-pole, 4.pol.FI (N left) + 8xLS, 11 units	111311	11	10mm ²	✓	10
Fork, 3-pole, 4.pol.FI (N right) + 8xLS, 12 units	111308	11	16mm ²	✓	5

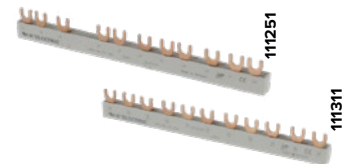

3-pole fork wiring rails | with HI switch

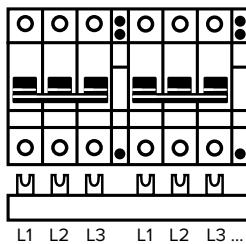

Item	Item no.	FN*	Cross section	End cap	PU
Fork, 3-pole + 9mm, 1,00m	111360	48	10mm ²	171003	10
Fork, 3-pole + 9mm, 1,00m	111365	48	16mm ²	171007	10



*FN = Number of flags

3-pole fork wiring rails | with HI switch after each pole

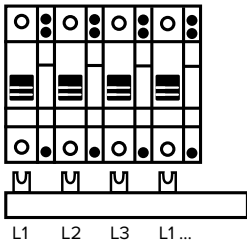

Item	Item no.	FN*	Cross section	End cap	PU
Fork, 3-pole, 27mm, 1.00m	111323	36	16mm ²	171007	20



4-pole fork wiring rails

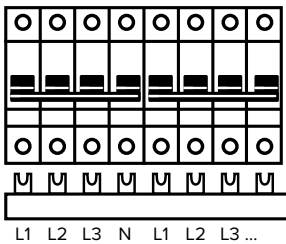

Item	Item no.	FN*	Cross section	End cap	PU
Fork, 4-pole, 1.00m	111316	56	10mm ²	171004	15
Fork, 4-pole, 8 units	111344	8	10mm ²	✓	5
Fork, 4-pole, 12 units	111258	12	10mm ²	✓	5
Fork, 4-pole, 1.00m	111317	56	16mm ²	171004	15
Fork, 4-pole, 8 units	111204	8	16mm ²	✓	5
Fork, 4-pole, 12 units	111214	12	16mm ²	✓	5
Fork, 4-pole, 1.00m	111054	56	35mm ²	171006 171005	5

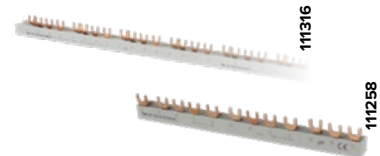

4-pole fork wiring rails | L1,N,L2,N,L3,N

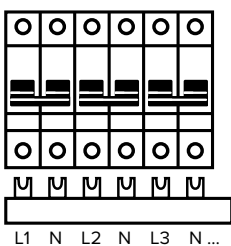

Item	Item no.	FN*	Cross section	End cap	PU
Fork, 4-pole, L1,N,L2,N,L3,N, 1.00m	111320	54	10mm ²	171004	15
Fork, 4-pole, L1,N,L2,N,L3,N, 12 units	111319	12	10mm ²	✓	5
Fork, 4-pole, L1,N,L2,N,L3,N, 1.00m	111322	54	16mm ²	171004	15
Fork, 4-pole, L1,N,L2,N,L3,N, 12 units	111321	12	16mm ²	✓	5

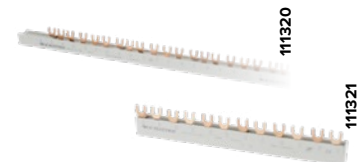

*FN = Number of flags

Fork – Wiring rails

for screw terminal with frame terminal

**TYTAN T | TYTAN T4H | TYTAN T4HP | TYTAN T4HR |
TYTAN TH1 | TYTAN THBus | TYTAN T4P**



3-pole fork wiring rails

Item	Item no.	FN*	Cross section	End cap	PU
Fork, 3-pole + 17.8mm, 1,00m	111056	42	16mm ²	171007	20
Fork, 3-pole + 17.8mm (2x3-pol)	111203	6	16mm ²	✓	10
Fork, 3-pole + 17.8mm (3x3-pol)	111213	9	16mm ²	✓	10
Fork, 3-pole + 17.8mm, 1,00m	111053	42	35mm ²	171006	5
Fork, 3-pole + 17.8mm (2x3-pol)	111223	6	35mm ²	✓	5
Fork, 3-pole + 17.8mm (3x3-pol)	111233	9	35mm ²	✓	5



4-pole fork wiring rails

Item	Item no.	FN*	Cross section	End cap	PU
Fork, 4-pole, 1,00m	111317	56	16mm ²	171004	15
Fork, 4-pole, 8 units	111204	8	16mm ²	✓	5
Fork, 4-pole, 12 units	111214	12	16mm ²	✓	5
Fork, 4-pole, 1,00m	111054	56	35mm ²	171006 171005	5
Fork, 4-pole, 8 units	111224	8	35mm ²	✓	5
Fork, 4-pole, 12 units	111234	12	35mm ²	✓	5

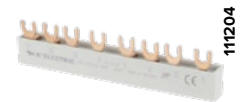

*FN = Number of flags

Matching end caps

Item	Item no.	PU
End cap 1/10-16	171001	50
End cap 2/10	171002	10
End cap 3/10	171003	10
End cap 4/16 & 4/10	171004	10
End cap 1/25-35	171005	10
End cap 3/25-35	171006	10
End cap 2/16 & 3/16	171007	10

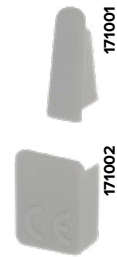

Touch protection

for pin or fork wiring rails

Item	Item no.	PU
Touch protection for wiring rails, yellow, 5 units	111249	10





ACHTUNG! Lesen Sie die Bedienungsanleitung des Herstellers. Beachten Sie die Warnhinweise im Handbuchs des Herstellers. Die Installation ist nur durch geschultes Personal zu erfolgen. Bei allen Arbeiten sind die üblichen Sicherheitsregeln zu beachten. Bei Beschädigung des Produkts ist es zu entsorgen.

ATTENTION: Lire attentivement le mode d'emploi du fabricant. Prendre en compte les avertissements du manuel du fabricant. L'installation doit être effectuée par un personnel qualifié. Lors de toutes les opérations, respecter les règles de sécurité habituelles. En cas de dommage au produit, celui-ci doit être éliminé.

¡ATENCIÓN! Lea detenidamente el manual de instrucciones del fabricante. Preste atención a las advertencias del manual del fabricante. La instalación debe ser realizada por personal cualificado. Durante todas las operaciones, respetar las reglas de seguridad habituales. En caso de daño al producto, éste debe ser eliminado.

Lightning & surge protection



Effective lightning and surge protection for buildings and systems and the users or occupants from the devastating effects of lightning strikes and voltage spikes. In an era where our dependence on electronic devices and complex technological systems, implementing reliable protection against lightning damage and surges in buildings is essential. These protective measures are not only important for the safety and smooth operation of electrical systems, but also for the preservation of electronic devices worthy of protection and the guarantee of a continuous power supply.

BUILDING

APPLICATION

INSTALLATION OF

Buildings with lightning protection class I and II

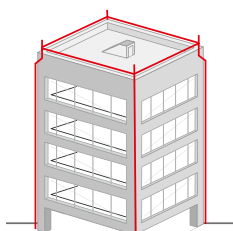

TYPE 1+2

Mains-side connection (NAR) or

		TT/TNS
	GT T1+2, 25kA, 3+1-300- FM	500200
	GT T1+2, 25kA, 3+1-275- FM , 4TE	500213
	GT T1+2, 25kA, 1+0-275- FM-SI	500220
		TNC
	GT T1+2, 25kA, 3+0-300- FM	500201
	GT T1+2, 25kA, 3+0-275- FM , 3TE	500214

Buildings with lightning protection class III and IV

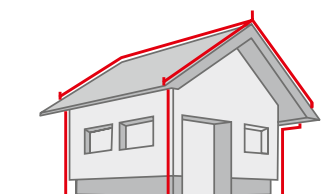

TYPE 1+2

		TT/TNS
	40mm	
	GT40 TT/TNS-12.5kA- B	500103
	GT40 TT/TNS-12.5kA- S	500101
	GT40 TT/TNS-12.5kA- SI	500110
	GTN40 TT/TNS-12.5kA- B	500131
	GTN40 TT/TNS-12.5kA- SI	500133
		TNC
	40mm	
	GT40 TNC-12.5kA- S	500107
	60mm	
	GTN40 TNC-12.5kA- B	500136
		TT/TNS
	60mm	
	GT60 TT/TNS-12.5kA, 3+1-300- FM	500161
		TNC
	60mm	
	GT60 TNC-12.5kA, 3+0-300- FM	500162

Buildings with overhead line feeds

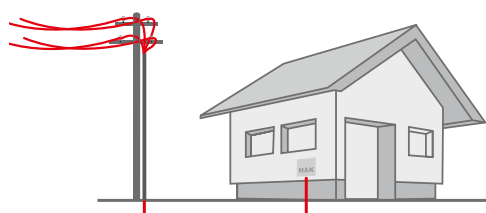

Buildings without external lightning protection



TYPE 1+2

		TT/TNS
	40mm	
	GT40 TT/TNS-7.5kA- B	500102
	GT40 TT/TNS-7.5kA- S	500100
	GT40 TT/TNS-7.5kA- SI	500109
	GTN40 TT/TNS-7.5kA- B	500130
	GTN40 TT/TNS-7.5kA- SI	500132
		TNC
	40mm	
	GT40 TNC-7.5kA- SI	500111
	60mm	
	GT40 TNC-7.5kA- S	500106
		TT/TNS
	60mm	
	GT60 TT/TNS-12.5kA, 3+1-300- FM-L	500160
		TNC
	60mm	
	GT60 TNC-12.5kA, 3+0-300- FM	500162

THE MAIN DISTRIBUTION

INSTALLATION OF THE SUB-DISTRIBUTION

Connection on the system side (ARR)

at distance to main distribution > 10m

TYPE 1+2

	GT T1+2, 12.5kA, 4+0-300- FM	TNS	500231
	GT T1+2, 12.5kA, 4+0-300- FM-L	TNS	500250
	GT T1+2, 12.5kA, 3+1-300- FM	TT/TNS	500230
	GT T1+2, 12.5kA, 3+1-300- FM-L	TT/TNS	500251
	GT T1+2, 12.5kA, 3+0-300- FM	TNC	500232
	GT T1+2, 12.5kA, 3+0-300- FM-L	TNC	500252
	60mm GT60 T1+2, 12.5kA, 3+1-300- FM-L	TT/TNS	500160
	60mm GT60 12.5kA, 3+1-300- FM	TT/TNS	500161
	60mm GT60 12.5kA, 3+0-300- FM	TNC	500162

TYPE 1+2

	GT T1+2, 12.5kA, 3+1-300- FM	TT/TNS	500230
	GT T1+2, 12.5kA, 3+1-300- FM-L	TT/TNS	500251
	GT T1+2, 12.5kA, 3+0-300- FM	TNC	500232
	GT T1+2, 12.5kA, 3+0-300- FM-L	TNC	500252
	60mm GT60 T1+2, 12.5kA, 3+1-300- FM-L	TT/TNS	500160
	60mm GT60 12.5kA, 3+1-300- FM	TT/TNS	500161
	60mm GT60 12.5kA, 3+0-300- FM	TNC	500162

TYPE 2

	GT T2, 3+1-300	TT/TNS	500302
	GT T2, 3+1-300- FM	TT/TNS	500303
	GT T2, 3+0-300- FM	TNC	500305
	60mm GT60 T2, 3+1-300- FM	TT/TNS	500163
	60mm GT60 T2-SI, 3+1-300- FM with back-up fuse	TT/TNS	500164
	60mm GT60 T2, 3+0-300- FM	TNC	500165
	60mm GT60 T2-SI, 3+0-300- FM with back-up fuse	TNC	500166

TYPE 2

	GT T2, 4+0-300	TNS	500300
	GT T2, 4+0-300- FM	TNS	500301
	GT T2, 3+1-300	TT/TNS	500302
	GT T2, 3+1-300- FM	TT/TNS	500303
	GT T2, 3+1-300- FM-SI	TT/TNS	500320
	GT T2+3, 3+1-275	TT/TNS	500306
	GT T2+3, 3+1-275- FM	TT/TNS	500307
	GT T2, 3+0-300- FM	TNC	500305
	60mm GT60 T2, 3+1-300- FM	TT/TNS	500163
	60mm GT60 T2-SI, 3+1-300- FM with back-up fuse	TT/TNS	500164
	60mm GT60 T2, 3+0-300- FM	TNC	500165
	60mm GT60 T2-SI, 3+0-300- FM with back-up fuse	TNC	500166

TYPE 2

	GT T2, 4+0-300	TNS	500300
	GT T2, 4+0-300- FM	TNS	500301
	GT T2, 3+1-300	TT/TNS	500302
	GT T2, 3+1-300- FM	TT/TNS	500303
	GT T2, 3+1-300- FM-SI	TT/TNS	500320
	GT T2+3, 3+1-275	TT/TNS	500306
	GT T2+3, 3+1-275- FM	TT/TNS	500307
	GT T2, 3+0-300- FM	TNC	500305
	60mm GT60 T2, 3+1-300- FM	TT/TNS	500163
	60mm GT60 T2-SI, 3+1-300- FM with back-up fuse	TT/TNS	500164
	60mm GT60 T2, 3+0-300- FM	TNC	500165
	60mm GT60 T2-SI, 3+0-300- FM with back-up fuse	TNC	500166

-B = basic
-L = leakage current
-S = with voltage tap
-FM = with remote signal contact
-SI = with fused voltage tap

Meter cupboard

Multipole, compact lightning current arrester

for the 40mm busbar system | Type 1+2+3

- ✓ Status display green / not green
- ✓ Installation in the pre-metering area

S = voltage tap for APZ field
 SI = fused voltage tap for APZ field
 B = basic (without voltage tap)

GT 40 | Construction width 47mm

For TT-/TNS systems | 7.5kA

Item	Item no.	PU
GT 40 TT/TNS-7.5kA-S	500100	1
GT 40 TT/TNS-7.5kA-B	500102	1
GT 40 TT/TNS-7.5kA-SI	500109	1



For TT-/TNS systems | 12.5kA

Item	Item no.	PU
GT 40 TT/TNS-12.5kA-B	500103	1
GT 40 TT/TNS-12.5kA-S	500101	1
GT 40 TT/TNS-12.5kA-SI	500110	1



For TNC systems | 7.5kA and 12.5kA

Item	Item no.	PU
GT 40 TNC-7.5kA-SI	500111	1
GT 40 TNC-12.5kA-S	500107	1
GT 40 TNC-7.5kA-S	500106	1



Accessories GTN 40

Item	Item no.	PU
Cable set for the GT 40 arrester with fused voltage tap	500120	1
GTN 40 E feed for the 40mm system	500135	1
APZ connection set	500139	1



GT 40 TT/TNS-7.5kA-SI

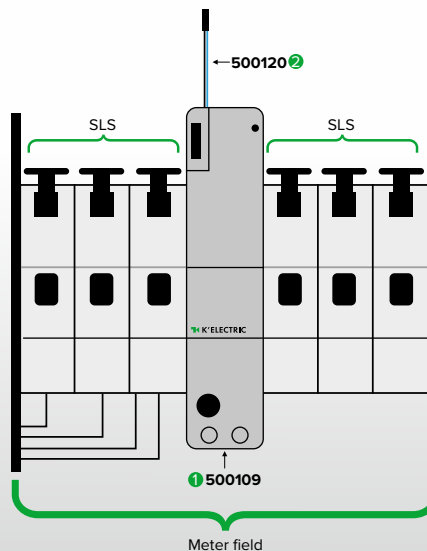

Meter cupboard

Multipole, compact lightning current arrester

for the 40mm busbar system | Type 1+2+3

- ✓ Status display green / not green
- ✓ Installation in the pre-metering area
- ✓ Plug & Play cable set for APZ and RfZ field
- ✓ Spare fuse included

GTN 40 | Baubreite 36mm

For TT-/TNS systems | 7.5kA

Item	Item no.	PU
GTN 40 TT/TNS-7.5kA-B	500130	1
GTN 40 TT/TNS-7.5kA-SI	500132	1

For TT-/TNS systems | 12.5kA

Item	Item no.	PU
GTN 40 TT/TNS-12.5kA-B	500131	1
GTN 40 TT/TNS-12.5kA-SI	500133	1

Accessories GTN 40

Item	Item no.	PU
GTN 40 cable set for the arrester with fused voltage tap	500134	1
GTN 40 E feed-in adapter	500135	1
APZ connection set	500139	1



GTN 40 TT/TNS-7.5kA-SI

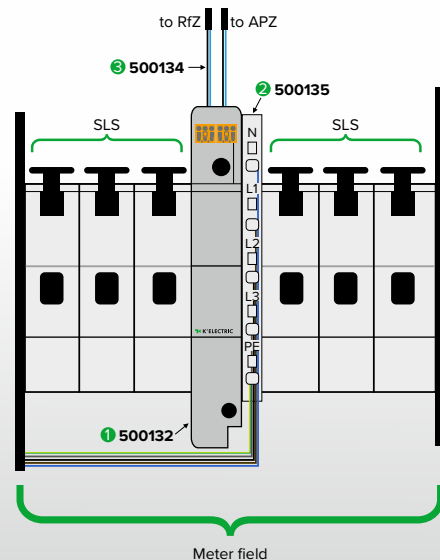

RfZ: Space for additional devices, APZ: Termination point meter location, SLS: Selective miniature circuit breaker

Multipole, compact lightning current arrester

for the 60mm system | Type 1+2 L = Leakage current

For the TT-/TNS system – T1+2

Item	Item no.	PU
GT60 T1+2, 12.5kA, 3+1-300-FM-L	500160	1
GT60 T1+2, 12.5kA, 3+1-300-FM	500161	1



500160

For the TT-/TNS system – T2

Item	Item no.	PU
GT60 T2, 3+1-300-FM	500163	1
GT60 T2-SI, 3+1-300-FM	500164	1

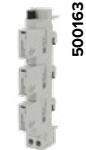

500163

For the TNC system – T1+2

Item	Item no.	PU
GT60 T1+2, 12.5kA, 3+0-300-FM	500162	1
GT60 T2-SI, 3+0-300-FM	500166	1



500166

Mit integrierter Vorsicherung

For the TNC system – T2

Item	Item no.	PU
GT60 T2, 3+0-300-FM	500165	1



500165



Multipole, pluggable AC lightning current combination arrestors

Typ 1+2 L = Leakage current (Use in the recourt area)

For the TT-/TNS system | Lightning protection class I and II | 25kA, with integrated fuse

Item	Item no.	PU
GT T1+2, 25kA, 1+0-275-FM-SI, 2 units	500220	1
GT T1+2, N-PE spark gap 100kA, 0+1, 1 units	500222	1
Wiring rail 6 units, folk, 16mm ²	500223	1
Wiring rail 7 units, folk, 16mm ²	500224	1



For the TT-/TNS system | Lightning protection class I and II | 25kA

Item	Item no.	PU
GT T1+2, 25kA, 3+1-300-FM, 8 units	500200	1
GT T1+2, 25kA, 3+1-275-FM, 4 units	500213	1



For the TNC system | Lightning protection class I and II | 25kA

Item	Item no.	PU
GT T1+2, 25kA, 3+0-300-FM, 6 units	500201	1
GT T1+2, 25kA, 3+0-275-FM, 3 units	500214	1



For 1-phase TN systems | Lightning protection class I and II | 25kA

Item	Item no.	PU
GT T1+2, 25kA, 1+1-275-FM	500215	1



For the TNS system | Lightning protection class III and IV | 12.5kA

Item	Item no.	PU
GT T1+2, 12.5kA, 4+0-300-FM	500231	1
GT T1+2, 12.5kA, 4+0-300-FM-L	500250	1



For the TT-/TNS system | Lightning protection class III and IV | 12.5kA

Item	Item no.	PU
GT T1+2, 12.5kA, 3+1-300-FM	500230	1
GT T1+2, 12.5kA, 3+1-300-FM-L	500251	1



For the TNC system | Lightning protection class III and IV | 12.5kA

Item	Item no.	PU
GT T1+2, 12.5kA, 3+0-300-FM	500232	1
GT T1+2, 12.5kA, 3+0-300-FM-L	500252	1



25kA

12.5kA

Lightning & surge
protection

Multipole, pluggable AC surge arresters

Type 2

SI = with fused voltage tap
FM = with remote signal contact

For the TNS system

Item	Item no.	PU
GT T2, 4+0-300	500300	1
GT T2, 4+0-300-FM	500301	1



For the TT-/TNS system

Item	Item no.	PU
GT T2, 3+1-300	500302	1
GT T2, 3+1-300-FM	500303	1
GT T2, 3+1-300-FM-SI	500320	1



With integrated back-up fuse!

For the TNC system

Item	Item no.	PU
GT T2, 3+0-300-FM	500305	1



For 1-phasesystem

Item	Item no.	PU
GT T2, 1+1-300-FM	500310	1



Type 2+3 Arrester narrow design

For the TT-/TNS system

Item	Item no.	PU
GT T2+3, 3+1-275, 2 units	500306	1
GT T2+3, 3+1-275-FM, 2 units	500307	1



For 1-phase TN systems

Item	Item no.	PU
GT T2+3, 1+1-275-FM, 1 unit	500308	1



Electromobility – Type 2

Item	Item no.	PU
GT T2-EM, 3+1-300-FM	500315	1
Cable set for GT T2-EM, 3+1-300-FM	500316	1



Compact combined arrester

for data/telecommunications systems, sun protection systems and fine protection

Telecommunications | Telephone | Network | EIB/KNX Bus | Blinds

Combined arrester for telecommunications systems – Type 1+2

Item	Item no.	PU
FM TEL20	500501	1



500501

Combined arrester for Ethernet – Type 1+2

for the protection of data networks and network devices, such as hubs, switches, servers, etc.

Item	Item no.	PU
FM Dat Net Cat6	500502	1



500502

End device protection – Type 3

Socket installation

Item	Item no.	PU
GT3 mini	500503	1

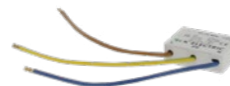

500503

KNX surge protection

Item	Item no.	PU
FM Dat KNX	500504	1



500504

Surge arrester – Type 2

Blind drives

Item	Item no.	PU
GT-AS-T2/3-275	500505	1



500505

Surge arrester – Type 3

Blind drives

Item	Item no.	PU
GT T3, 24V FM	500510	1



500510

Protection of PV roof systems

When is a type 1 or a type 2 SPD used?

No external lightning protection system available

AC side: type 1 or also type 2
DC side: type 2

An external lightning protection system is in place and the **separation distance** to the frame of the PV system is **maintained**

AC side: type 1
DC side: type 2

An external lightning protection system is in place and the **separation distance** to the frame of the PV system is **not maintained**

AC side: type 1
DC side: type 1

Recommendation according to DIN VDE 0100-534: If the power length of an SPD exceeds > 10m, an additional SPD should be installed as close as possible to the terminal device to be protected.

AC solutions



Lightning protection system

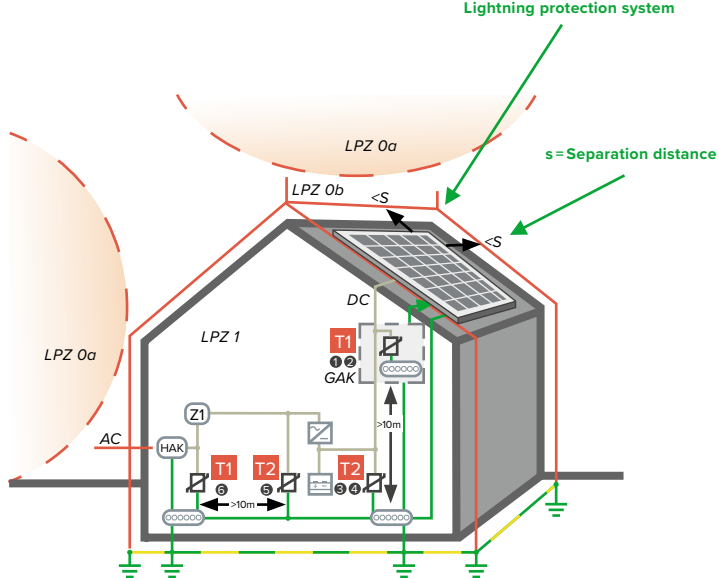

DC solutions

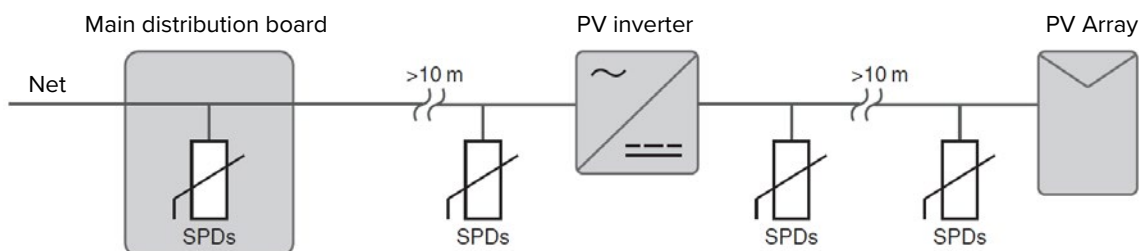

Multipole, pluggable arresters for photovoltaic applications

Type 1+2 | Type 2

Combined arrester type 1+2, 1100V DC

Item	Item no.	PU
PV T1+2, 3 units 1100V-FM	500400	1
PV T1+2, 3 units 1100V	500401	1
PV T1+2, 5 units 1100V	500425	1



500401

Surge arrester type 2, 1100V DC

Item	Item no.	PU
PV T2, 3 units 1100V	500420	1
PV T2, 3 units 1100V-FM	500421	1
PV T2, 5 units 1100V	500424	1



500424

Combined arrester type 1+2, 1500V DC

Item	Item no.	PU
PV T1+2, 1500V-FM	500402	1
PV T1+2, 1500V	500403	1



500403

Surge arrester type 2, 1500V DC

Item	Item no.	PU
PV T2, 1500V	500422	1
PV T2, 1500V-FM	500423	1



500420

Generator connection box

with transparent cover and pre-assembled cable glands

Generator connection box type 1+2, 1100V DC

Item	Item no.	PU
GAK 1x2, T1+T2, 1MPP, 2 Strings, each MPP 2 in 2 out, 200x200x132mm, Cable gland	165621	1
GAK 2x2, T1+T2, 2MPP, 4 Strings, each MPP 2 in 2 out, 300x200x132mm, Cable gland	165620	1



165621

Item	Item no.	PU
*GAK 3x2, T1+T2, 3MPP, 6 Strings, each MPP 2 in 2 out, 400x300x132mm, Cable gland	136113	1



136113

Item	Item no.	PU
*GAK 4x2, T1+T2, 4MPP, 8 Strings, each MPP 2 in 2 out, 600x300x132mm, Cable gland	136114	1
*GAK 5x2, T1+T2, 5MPP, 10 Strings, each MPP 2 in 2 out, 600x300x132mm, Cable gland	136115	1

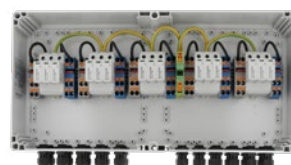

136115

Item	Item no.	PU
*GAK 6x2, T1+T2, 6MPP, 12 Strings, each MPP 2 in 2 out, 600x400x132mm, Cable gland	136116	1
*GAK 9x2, T1+T2, 9MPP, 18 Strings, each MPP 2 in 2 out, 600x400x132mm, Cable gland	136119	1
*GAK 10x2, T1+T2, 10MPP, 20 Strings, each MPP 2 in 2 out, 600x400x132mm, Cable gland	136120	1

*closed lid

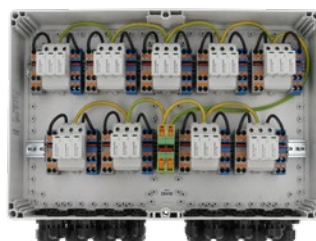

136119

Generator connection box type 2, 1100V DC

Item	Item no.	PU
GAK 1x2, T2, 1MPP, 2 Strings, each MPP 2 in 2 out, 200x200x132mm, Cable gland	165639	1
GAK 2x2, T2, 2MPP, 4 Strings, each MPP 2 in 2 out, 300x200x132mm, Cable gland	165640	1
GAK 3x2, T2, 3MPP, 6 String, each MPP 2 in 2 out, 400x300x132mm, Cable gland	165641	1



165640

Generator connection box type 1+2, 1100V DC

Item	Item no.	PU
GAK 1x2, T1+T2, 1MPP, 2 Strings, each MPP 2 in 1 out, 200x200x132mm, Cable gland	134050	1
GAK 1x1, T1+T2, 1MPP, 1 String, each MPP 1 in 1 out, 200x200x132mm, Cable gland	134051	1
GAK 1x2, T1+T2, 1MPP, 2 Strings, each MPP 2 in 1 out, 210x210x132mm, Connection MC4	134052	1
GAK 1x1, T1+T2, 1MPP, 1 String, each MPP 1 in 1 out, 210x210x132mm, Connection MC4	134053	1
Item	Item no.	PU
GAK 2x2, T1+T2, 2MPP, 4 Strings, each MPP 2 in 1 out, 210x210x132mm, Cable gland	134054	1
GAK 2x1, T1+T2, 2MPP, 2 Strings, each MPP 1 in 1 out, 210x210x132mm, Cable gland	134055	1
GAK2x2, T1+T2, 2MPP, 4 Strings, each MPP 2 in 1 out, 210x210x132mm, Connection MC4	134056	1
GAK 2x1, T1+T2, 2MPP, 2 Strings, each MPP 1 in 1 out, 210x210x132mm, Connection MC4	134057	1



Generator connection box type 2, 1100V DC

Item	Item no.	PU
GAK 1x2, T2, 1MPP, 2 Strings, each MPP 2 in 1 out, 210x210x132mm, Cable gland	134000	1
GAK 1x1, T2, 1MPP, 1 String, each MPP 1 in 1 out, 210x210x132mm, Cable gland	134001	1
GAK 1x2, T2, 1MPP, 2 Strings, each MPP 2 in 1 out, 210x210x132mm, Connection MC4	134002	1
GAK 1x1, T2, 1MPP, 1 String, each MPP 1 in 1 out, 210x210x132mm, Connection MC4	134003	1
Item	Item no.	PU
GAK 2x2, T2, 2MPP, 4 Strings, each MPP 2 in 1 out, 210x210x132mm, Cable gland	134004	1
GAK 2x1, T2, 2MPP, 2 Strings, each MPP 1 in 1 out, 210x210x132mm, Cable gland	134005	1
GAK2x2, T2, 2MPP, 4 Strings, each MPP 2 in 1 out, 210x210x132mm, Connection MC4	134006	1
GAK 2x1, T2, 2MPP, 2 Strings, each MPP 1 in 1 out, 210x210x132mm, Connection MC4	134007	1



MC4 mini GAK's, 1100V DC

Item	Item no.	PU
Mini GAK 2x2, T2, 2MPP, 2 Strings, each MPP 1 in 1 out, 160x160x93mm, Connection MC4	500650	1
Mini GAK 2x2, T1+T2, 2MPP, 2 Strings, each MPP 1 in 1 out, 160x160x93mm, Connection MC4	500600	1





Padlock

Switch cabinet accessories



Small, simple helpers are often missing for many applications, which complete the projects, guide cables or supplement the touch protection.

Blind cover

for distribution box: 12 place units, 220mm length

Item	Item no.	PU
Blind cover for distribution box, grey	111400	50
Blind cover for distribution box, grey	111400/500	500
Blind cover for distribution box, white	111401	50
Blind cover for distribution box, white	111401/500	500
Locking for blind cover	111405	10

Item	Item no.	PU
Blind cover for distribution box perforated, white	111403	50
Blind cover for distribution box perforated, grey	111404	50

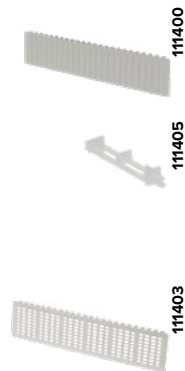

Blank panel

for the 60mm system cut-out (195mm):
universally applicable by spring technology | divisible in 9mm units

Item	Item no.	PU
Blank panel 195mm x 54mm for system coverage, grey	136078	10
Blank panel 195mm x 54mm for system coverage, white	136079	10

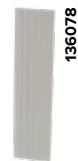

Lock

Item	Item no.	PU
Padlock	104664	1



Low angle brackets

Item	Item no.	PU
Low angle bracket for DIN rail small	170112	10
Low angle bracket for DIN rail big	170113	10



DIN rail spacer

for heat relief | grey | universally applicable

Item	Item no.	PU
Spacer 9mm for DIN rail 35mm	170120	40



Cu flat rails

tinned and round-edged

Item	Max. current carrying capacity	Item no.	PU
Busbar Cu tinned 12x5mm; 2m length	200 A	156040	5
Busbar Cu tinned 15x5mm; 2m length	250 A	156041	5
Busbar Cu tinned 20x5mm; 2m length	320 A	156042	5
Busbar Cu tinned 30x5mm; 2m length	450 A	156044	5
Busbar Cu tinned 20x10mm; 2m length	520 A	156047	5
Busbar Cu tinned 30x10mm; 2m length	630 A	156049	5



156040

DIN rail socket

- ✓ Version "Schuko"
- ✓ Construction width 2.5 units
- ✓ Snap-on mounting with lock
- ✓ For service distribution boards and metering points according to VDE 0603
- ✓ For plugs and socket outlets for domestic use and similar purposes according to VDE 0620, Teil 1 / 2005-04

Item	Item no.	PU
DIN rail socket grey for DIN rail 35mm	170150	5
DIN rail socket yellow	170151	5
DIN rail socket red	170152	5
DIN rail socket orange	170153	5
DIN rail socket grey with lid for DIN rail 35mm	170154	5



Support insulators

Item	Height	Item no.	PU
Support insulator 20-6	20mm	210520.06	25
Support insulator 25-6	25mm	210525.06	25
Support insulator 30-6	30mm	210530.06	25
Support insulator 30-8	30mm	210530.08	25
Support insulator 30-10	10mm	210530.10	25
Support insulator 35-8	35mm	210535.08	25
Support insulator 35-10	35mm	210535.10	25
Support insulator 40-8	40mm	210540.08	25
Support insulator 40-10	40mm	210540.10	25
Support insulator 50-10	50mm	210550.10	25
Support insulator 50-12	50mm	210550.12	25
Support insulator 55-10	55mm	210555.10	25
Support insulator 60-10	60mm	210560.10	25
Support insulator 60-12	60mm	210560.12	25
Support insulator 65-10	65mm	210565.10	25
Support insulator 70-10	70mm	210570.10	25
Support insulator 75-10	75mm	210575.10	25
Support insulator 75-12	75mm	210575.12	25



Service box for the DIN rail

Reserve box for small parts

Item	Item no.	PU
TYTAN II Plastic box pink (2 A) empty	101102	1
TYTAN II Plastic box brown (4 A) empty	101104	1
TYTAN II Plastic box green (6 A) empty	101106	1
TYTAN II Plastic box red (10 A) empty	101110	1
TYTAN II Plastic box grey (16 A) empty	101116	1
TYTAN II Plastic box blue (20 A) empty	101120	1
TYTAN II Plastic box yellow (25 A) empty	101125	1
TYTAN II Plastic box purple (32 A) empty	101132	1
TYTAN II Plastic box black (35 A) empty	101135	1
TYTAN II Plastic box white (50 A) empty	101150	1
TYTAN II Plastic box copper (63 A) empty	101163	1

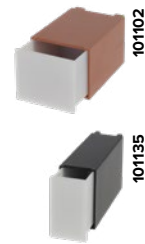

TYTAN® II Service box for the DIN rail

printed with your individual logo

- ✓ Selectable housing colors: pink, brown, green, red, blue, yellow, black, white, ochre
- ✓ Insert with individual company logo printed in color (CMYK) in high resolution

Item	Item no.	PU
TYTAN II Plastic box empty incl. print	101100_PRINT	90



Document pockets

Document pocket 1013U-1

- ✓ Document pocket grey
- ✓ Made of polystyrene in RAL 7035
- ✓ Impact resistant
- ✓ Self-adhesive
- ✓ Screw fixing possible
- ✓ Size corresponds to DIN A4
- ✓ Inner dimensions (HxWxD): 230x220x30mm

Item	Item no.	PU
Document pocket Polystyrol DIN A4, RAL 7035	195001	25



195001

Foil document pocket

- ✓ Self-adhesive
- ✓ Size corresponds to DIN A4
- ✓ Dimensions (WxH): 230x305mm

Item	Item no.	PU
Document pocket DIN A4, Foil for gluing	195002	25



195002

Document pocket with expansion fold

- ✓ Cardboard reinforced back panel
- ✓ Only as deep as the documents
- ✓ Self-adhesive
- ✓ Size corresponds to DIN A4
- ✓ Back panel (WxH): 245x315mm

Item	Item no.	PU
Document pocket DIN A4 cardboard reinforced with expansion fold	195003	25



195003

Document pocket

- ✓ Cardboard reinforced back panel
- ✓ Self-adhesive
- ✓ Size corresponds to DIN A6
- ✓ Dimensions (WxH): 120x185mm

Item	Item no.	PU
Document pocket DIN A6 cardboard reinforced	195004	25



195004

Document pocket with expansion fold

- ✓ Cardboard reinforced back panel
- ✓ Only as deep as the documents
- ✓ Self-adhesive
- ✓ Size corresponds to DIN A5
- ✓ Back panel (BxH): 153x230mm

Item	Item no.	PU
Document pocket DIN A5 cardboard reinforced with expansion fold	195005	25



195005

With individual printing

Item	Item no.	PU
Document pocket DIN A4, RAL 7035	195001/PRINT	25
Document pocket DIN A4, Foil for gluing	195002/PRINT	25
Document pocket DIN A4 cardboard reinforced with expansion fold	195003/PRINT	25



195001/PRINT



195002/PRINT



195003/PRINT

Cable collector

for switch cabinet construction

- ✓ Suitable for top-hat rails from Striebel & John, Hager and Siemens
- ✓ Hager and Siemens cable collector can be mounted on perforated top-hat rails (1.0mm | 1.5mm thickness)
- ✓ Striebel & John cable collector can be mounted on EDF and WR frames and 1.5 mm top-hat rail
- ✓ Simple locking of the cable holder
- ✓ In different sizes

Item	Item no.	PU
Cable collector red large for Striebel systems	170101	100



170101

Item	Item no.	PU
Cable collector blue large for Hager systems	170102	100



170102

Item	Item no.	PU
Cable collector grey large for Siemens and Eaton systems	170103	100



170103

Item	Item no.	PU
Cable collector red small for Striebel systems	170104	100



170104

Item	Item no.	PU
Cable collector blue small for Hager systems	170105	100



170105

Item	Item no.	PU
Cable collector gray small for Siemens and Eaton systems	170106	100



170106

Item	Item no.	PU
Universal cable collector red	170100	50 / 100 / 1000



170100

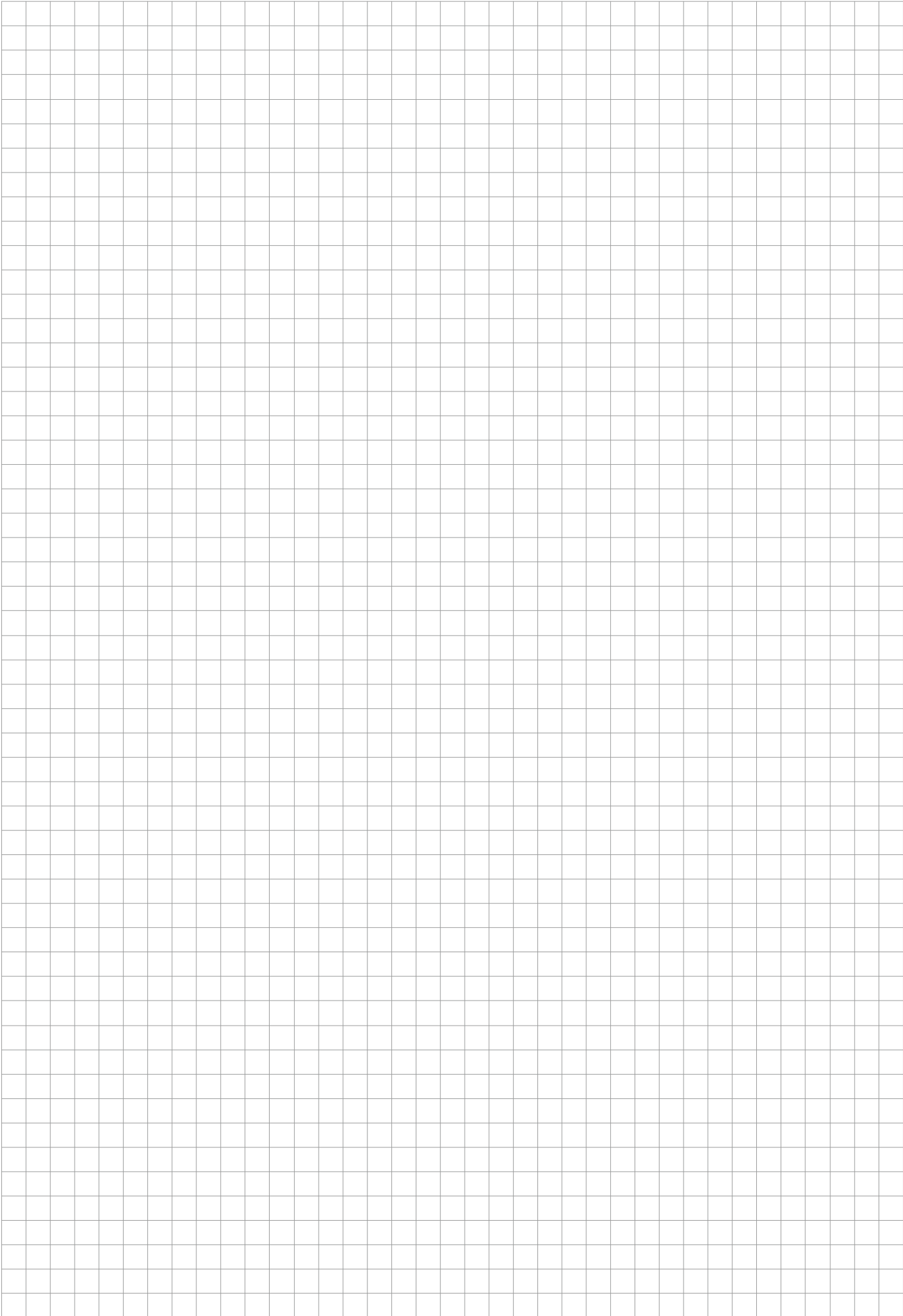

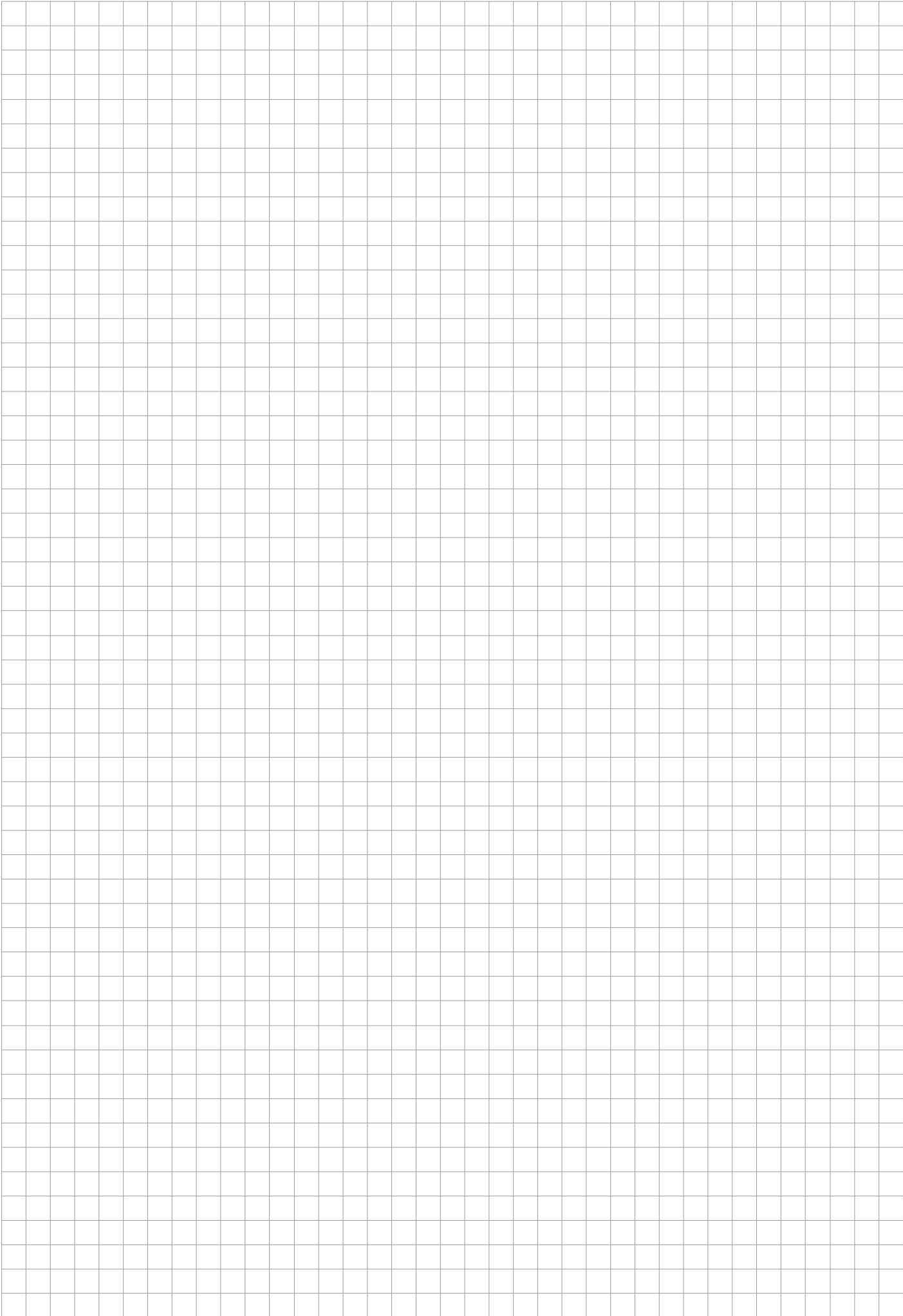



WE CONNECT TO PROTECT



IMPRINT

K'ELECTRIC GmbH | Carl-Benz-Straße 7 | 95448 Bayreuth | Germany

Contact

Phone: +49 921 151 26 78-0

Fax: +49 921 151 26 78-20

E-mail: office@k-electric-gmbh.de

Web: www.k-electric-gmbh.de

© 2024 | Changes and errors excepted

Design & typography:

K'ELECTRIC GmbH, Bayreuth

