

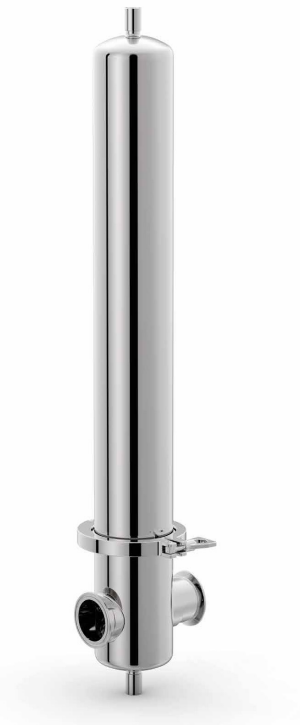

ULTRAFILTER
THE FILTRATION MANUFACTURER
THE SCANDINAVIAN FILTRATION PARTNER

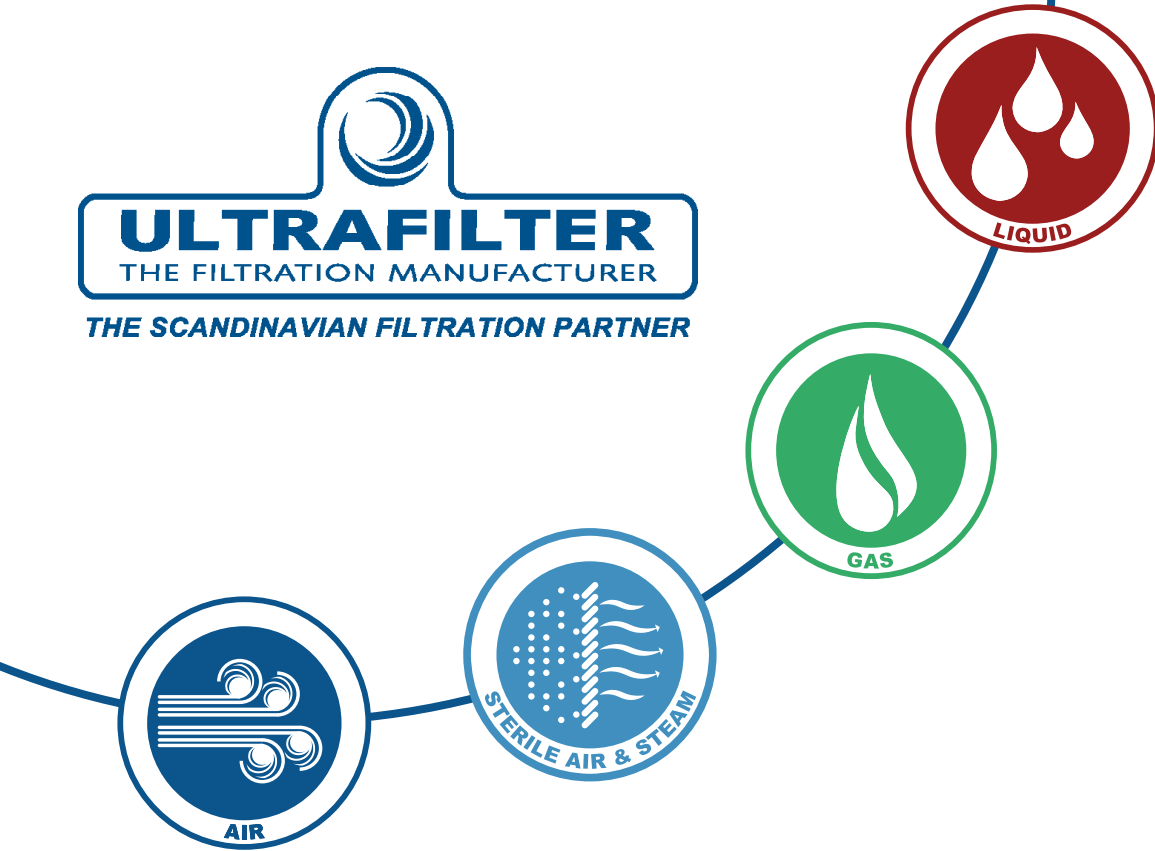

ULTRAFILTER P-EG STEAM FILTER HOUSING



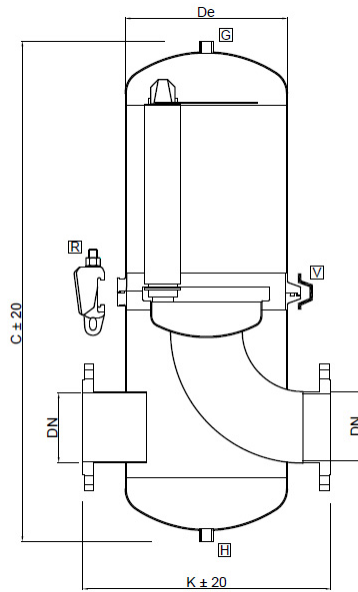

WWW.ULTRA-FILTER.COM

SANITARY FILTER HOUSING

PG-EG



Technical Data

-  SS316L / 1.4404
-  Ra 0,8 / Shot Blasted
-  150°C
-  Silicone FDA BGA Approved

For particular high quality demands, we offer our sanitary filter housing PG-EG for steam filtration.

PG-EG stainless steels have been developed for the purification of compressed air and other technical gases in pharmaceutical, biotechnology and chemical industries.

PG-EG houses are “first choice” in critical applications in sterile filtration.

Data

| Data | |
|--------------------------------|----------------------------|
| Vessel | PG-EG |
| Fluid Group | 2 (Not Dangerous) |
| Design Pressure (PS) min. max. | -1 ÷ 5 bar |
| Design Temperature (TS) max. | 150 °C |
| Test Pressure (PT) | 11,5bar |
| Cartridge Socket | Code 7 |
| Vessel Material | 316L / 1.4404 |
| Seals Material | Silicone FDA BGA Approved |
| Internal Finishing Upstream | Pickled |
| Internal Finishing Downstream | Mechanical Polishing |
| Internal Roughness | RA<0,8 micron |
| External Finishing | Shot Blasted |
| Vent Connection (G) | BSP ½” Female / Clamp 1,5” |
| Drain Connection (H) | BSP ½” Female / Clamp 1,5” |



| Dimensional Data | | | | | | | | |
|------------------|---------------------------|------------------|-------|------|------|-------------------|-------------------------|------------------|
| Vessel Model | Cartridge N° x Length (N) | Fastening System | De mm | C mm | K mm | Connection DN max | Total Volume litres (V) | PED Category (M) |
| PG-EG 031 | 03x10" | V | Ø219 | 829 | 443 | 100 | 33 | I |
| PG-EG 032 | 03x20" | | | 1079 | | | 42 | II |
| PG-EG 033 | 03x30" | | | 1329 | | | 51 | II |
| PG-EG 034 | 03x40" | | | 1579 | | | 60 | II |
| PG-EG 051 | 05x10" | V | Ø273 | 875 | 511 | 125 | 46 | II |
| PG-EG 052 | 05x20" | | | 1125 | | | 61 | II |
| PG-EG 053 | 05x30" | | | 1375 | | | 75 | II |
| PG-EG 054 | 05x40" | | | 1625 | | | 89 | II |
| PG-EG 081 | 08x10" | R | Ø320 | 935 | 515 | 125 | 59 | II |
| PG-EG 082 | 08x20" | | | 1175 | | | 82 | II |
| PG-EG 083 | 08x30" | | | 1425 | | | 101 | II |
| PG-EG 084 | 08x40" | | | 1675 | | | 120 | II |
| PG-EG 121 | 12x10" | R | Ø400 | 1127 | 665 | 150 | 122 | II |
| PG-EG 122 | 12x20" | | | 1377 | | | 156 | II |
| PG-EG 123 | 12x30" | | | 1627 | | | 186 | II |
| PG-EG 124 | 12x40" | | | 1877 | | | 217 | III |
| PG-EG 191 | 19x10" | R | Ø400 | 1127 | 665 | 150 | 133 | II |
| PG-EG 192 | 19x20" | | | 1377 | | | 167 | II |
| PG-EG 193 | 19x30" | | | 1627 | | | 201 | III |
| PG-EG 194 | 19x40" | | | 1877 | | | 228 | III |
| PG-EG 241 | 24x10" | R | Ø500 | 1365 | 650 | 200 | 304 | III |
| PG-EG 242 | 24x20" | | | 1615 | | | 362 | III |
| PG-EG 243 | 24x30" | | | 1865 | | | 420 | III |
| PG-EG 244 | 24x40" | | | 2115 | | | 478 | III |
| PG-EG 321 | 32x10" | R | Ø500 | 1365 | 650 | 200 | 304 | III |
| PG-EG 322 | 32x20" | | | 1615 | | | 362 | III |
| PG-EG 323 | 32x30" | | | 1865 | | | 420 | III |
| PG-EG 324 | 32x40" | | | 2115 | | | 478 | III |

FASTENING SYSTEMS: V = VEE BAND, R = SCREW CLAMP



THE SCANDINAVIAN FILTRATION PARTNER

SHOP ONLINE

At www.ultra-filter.com you will find a wide selection of filtration products ready for you to order.



www.ultra-filter.com

ABOUT US

Ultrafilter Scandinavia offers a wide selection of filtration products for compressed air, liquids and gas. We have stock in Denmark and from here we distribute all of our products to Scandinavia and the Baltic countries.

Ultrafilter Scandinavia is a part of the Ultrafilter group. Our production facility is in Germany and we have several subsidiaries in Europe and the United States.

You can buy our products on local websites. Information about our products as well as brochures and manuals can be found on our website (www.ultra-filter.com).

We can adapt all of our filtration products to your needs, and we offer visits from our consultants in order to find the right solution for you. We also offer on going service on our products once they are installed.

FILTRATION OF

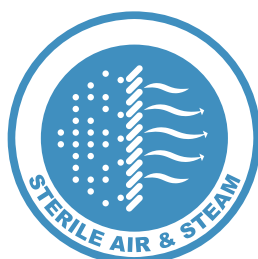

ULTRAFILTER SKANDINAVIEN APS

Sunekær 1
5471 Søndersø
Denmark

+45 82 30 30 20
info@ultra-filter.com
www.ultra-filter.com