

# Turcon® Variseal®

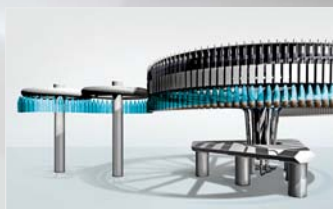



## Your Partner for Sealing Technology

Trelleborg Sealing Solutions is a major international developer, manufacturer and supplier of seals, bearings and molded components in polymers. We are uniquely placed to offer dedicated design and development from our market-leading product and material portfolio: a one-stop-shop providing the best in elastomer, silicone, thermoplastic, PTFE and composite technologies for applications in aerospace, industrial and automotive industries.

With 50 years of experience, Trelleborg Sealing Solutions engineers support customers with design, prototyping, production, test and installation using state-of-the-art design tools. An international network of over 70 facilities worldwide includes over 20 manufacturing sites, strategically-positioned research and development centers, including materials and development laboratories and locations specializing in design and applications.

Developing and formulating materials in-house, we utilize the resource of our material database, including over 2,000

proprietary compounds and a range of unique products. Trelleborg Sealing Solutions fulfills challenging service requirements, supplying standard parts in volume or a single custom-manufactured component, through our integrated logistical support, which effectively delivers over 40,000 sealing products to customers worldwide.

Trelleborg Sealing Solutions facilities are certified according to current market-related quality standards. In addition to the established ISO 9001 standard, our facilities are certified to environmental, health and safety standards, as well as specific customer specifications. These certifications are in many cases prerequisites, allowing us to comply to all market segment requirements.

**ISO 9001**

The information in this brochure is intended to be for general reference purposes only and is not intended to be a specific recommendation for any individual application. The application limits for pressure, temperature, speed and media given are maximum values determined in laboratory conditions. In application, due to the interaction of operating parameters, maximum values may not be achieved. It is vital therefore, that customers satisfy themselves as to the suitability of product and material for each of their individual applications. Any reliance on information is therefore at the user's own risk. In no event will Trelleborg Sealing Solutions be liable for any loss, damage, claim or expense directly or indirectly arising or resulting from the use of any information provided in this brochure. While every effort is made to ensure the accuracy of information contained herewith, Trelleborg Sealing Solutions cannot warrant the accuracy or completeness of information.

**To obtain the best recommendation for a specific application, please contact your local Trelleborg Sealing Solutions marketing company.** This edition supersedes all previous brochures. This brochure or any part of it may not be reproduced without permission.

© All trademarks are the property of Trelleborg Group. The turquoise color is a registered trademark of Trelleborg Group. © 2020, Trelleborg Group. All rights reserved.

---

## Contents

<b>04</b>	<b>Choosing the Right Seal for your Application</b>	<b>18</b>	<b>Groove Design – Inch</b>
<b>05</b>	<b>General</b>	<b>20</b>	<b>Surface Roughness</b>
<b>08</b>	<b>Turcon® Seal Materials</b>	<b>22</b>	<b>Turcon® Variseal® M2, M2S, W2, H</b>
<b>09</b>	<b>Zurcon® Seal Materials</b>	<b>46</b>	<b>Turcon® Variseal® HF</b>
<b>11</b>	<b>Spring Types and Materials</b>	<b>60</b>	<b>Turcon® Roto Variseal®</b>
<b>12</b>	<b>Quality Criteria</b>	<b>67</b>	<b>Special Types</b>
<b>13</b>	<b>Hardware Design Considerations</b>	<b>70</b>	<b>General Quality Criteria and Guidelines for Storage</b>
<b>14</b>	<b>Basic Gland Types</b>	<b>73</b>	<b>Conversion Tables</b>
<b>15</b>	<b>Preventing Seal Damage</b>	<b>84</b>	<b>Company Profile</b>
<b>16</b>	<b>Groove Design – Metric</b>	<b>90</b>	<b>Engineering Tools &amp; Apps</b>



## ■ Choosing the Right Seal for your Application

Turcon® Variseal® offers major benefits in the design of components such as cylinders. These include:

- Excellent leakage control
- High resistance to wear
- High resistance to extrusion into gaps
- Withstanding aggressive and abrasive process media
- Very good temperature capabilities
- Low friction
- Compact form

Turcon® Variseal® is available in a range of geometries and designs that allow the optimum profile to be selected for each application. They can be produced from a wide range of Turcon® materials, our proprietary PTFE based compounds. These are specially formulated for sealing elements and offer superior characteristics specifically matched to the demands of our customers.

When required, Variseal® can also be manufactured from Zurcon® Z80, our UHMWPE based material or Zurcon® Z48, our Thermoplastic Elastomer material.

To choose the best Turcon® Variseal® for your application, you must first decide the functional parameters. Table 1 and Table 2 on page 6 and Table 3 on page 7 can then be used to make an initial selection of seals and materials. These tables give details of where further details can be found in the catalog.

It is also important to consider the quality of the mating surface, which has a significant effect on the function and service life of the sealing system. Guidelines on these are given on page 20 and page 21.

If help is required in specification of a seal then contact Trelleborg Sealing Solutions. To find your local marketing company go to [www.tss.trelleborg.com](http://www.tss.trelleborg.com).



## ■ General

Turcon® Variseal® are single acting, spring-energized seals which are used for dynamic and static applications.

Variseal® are effective in a wide range of applications. They are chosen when higher resistance to chemical media is required, if the seal is required to operate in extremes of temperature and/or where good extrusion and compression characteristics are needed.

Turcon® Variseal® designs have three main characteristics:

- Application specific U-shaped seal profile
- Spring geometry suited to the particular application
- Proven high-performance Turcon® or Zurcon® polymers

Standard or custom geometries available in metric, inch and intermediate sizes ranging from 2 to 3,300 mm / 0.079 to 126 inches.

### METHOD OF OPERATION

All Variseal® designs included in this catalog have the same operating principle and differ only in their profile form and type of metallic spring used.

The Variseal® spring supplies the load required for sealing at low pressures (Figure 1). The "U" shaped jacket allows fluid pressure to energize the sealing lips, so total sealing pressure rises with increasing operating pressure (Figure 2).

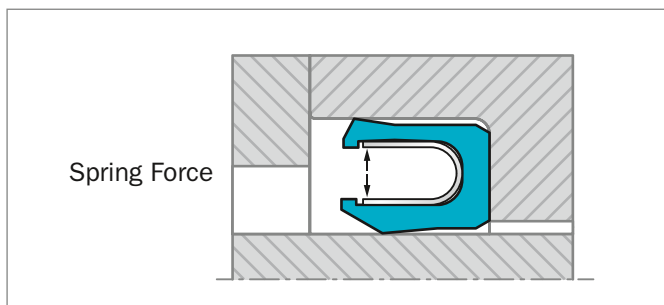

Figure 1: Turcon® Variseal® without system pressure

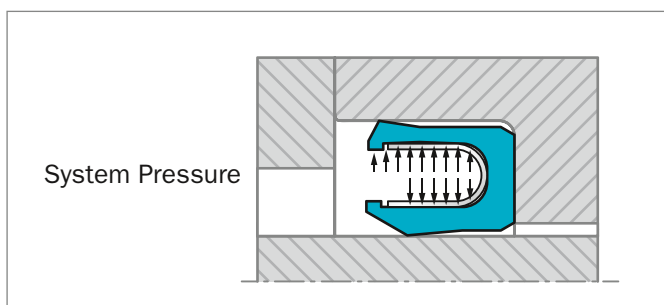

Figure 2: Turcon® Variseal® with system pressure







### PERFORMANCE

The different types of Variseal® designs combined with the properties of Turcon® and Zurcon® materials offer design engineers a wide range of solutions to a large number of applications.

The most important characteristics of Variseal® designs are listed below:

- Very low coefficient of friction
- Good dynamic and static sealing
- Capable of sealing at high speeds up to 15 m/s / 2,940 fpm
- Almost universal chemical compatibility
- Operating temperature of -253 °C up to +300 °C (-423 °F to +572 °F)
- Very good thermal resistance
- Properties unaffected by contact with chemicals
- Good aging characteristics
- Low compression set
- Capable of withstanding high pressures above 200 MPa (2,000 bar / 29,000 psi) when using Back-up Rings
- Very good dry-running properties
- Can be installed in grooves according to AS4716 (Mil-G-5514 is an old spec) and DIN 3771

**Table 1: Turcon® Variseal® Selection Table**

Seal		Application			Technical Data				
Type	Page	Type of Application			Maximum Pressure		Working Temp. °C / (°F)	Maximum Speed	
		Static	Reciprocating	Rotary	Dynamic MPa (bar, psi)	Static MPa (bar, psi)		Reciprocating m/s (fpm)	Rotating m/s (fpm)
<b>M2</b> 	page 22	C	A	B	20 (200, 2900)	40 (400, 5800)	-70 to +300 (-94 to +572)	15 (2940)	1.27 (250)
<b>M2S</b> 	page 23	C	A	C	20 (200, 2900)	40 (400, 5800)	-70 to +300 (-94 to +572)	15 (2940)	1.27 (250)
<b>W2</b> 	page 24	C	A	B	20 (200, 2900)	40 (400, 5800)	-70 to +300 (-94 to +572)	15 (2940)	1.27 (250)
<b>H</b> 	page 25	A	B	C	20 (200, 2900)	40 (400, 5800)	-100 to +200 (-148 to +392)	5 (985)	0.10 (18)
<b>HF</b> 	page 46	A	-	C	n/a	60 (600, 8702)	-150 to +200 (-238 to +392)	n/a	n/a
<b>Roto</b> 	page 60	B	B	A	20 (200, 2900)	25 (250, 3626)	-70 to +300 (-94 to +572)	15 (2940)	2.00 (360)

Properties: A Excellent B Good C Satisfactory

**Table 2: Application Guide**

Contact medium or operating condition	Static or slightly Dynamic	Reciprocating	Rotating
Air, Gas	Turcon® T05	Turcon® T24	Turcon® T24
Water, Steam	Turcon® T05	Turcon® T40	Turcon® T40
Oil, Crude oil	Turcon® T05	Turcon® T40	Turcon® T40
General chemical	Turcon® T05	Turcon® T40	Turcon® T40
Petrochemicals	Turcon® T05	Turcon® T40	Turcon® T40
Food, Drugs	Turcon® MF1	Zurcon® Z80 <sup>1)</sup>	Turcon® MF6
Vacuum	Turcon® T01	Turcon® T05	Turcon® T05

1) Maximum operating temperature +80 °C (+176 °F). In a pressure-free state, sterilization is possible for a short period at higher temperature

**Table 3: Turcon® and Zurcon® Material Selection Guide**

Material Code	Material Description	Temperature Range °C (°F)	Chemical Compatibility	Radiation Resistance
T01 / MF1*	Premium grade virgin PTFE for static, slow dynamic or light duty applications. MF1 for food contact service. Color: white	-253 to +260 (-423 to +500)	A	7 x 10 <sup>2</sup> Gray (7 x 10 <sup>4</sup> Rads)
T05	Premium grade modified PTFE. Light duty material with greater wear resistance than Turcon T01. Reciprocating and slow rotary applications. Color: turquoise	-200 to +260 (-328 to +500)	A	7 x 10 <sup>2</sup> Gray (7 x 10 <sup>4</sup> Rads)
T07	Proprietary polymer-reinforced compound for long wear life in difficult combinations of pressure and temperature. Color: black	-60 to +300 (-76 to +572)	A	7 x 10 <sup>2</sup> Gray (7 x 10 <sup>4</sup> Rads)
T12	Use where poor lubrication is a problem, good performance in valve applications. Color: black	-60 to +300 (-76 to +572)	A	7 x 10 <sup>2</sup> Gray (7 x 10 <sup>4</sup> Rads)
T24	High-grade formulation of virgin polytetrafluoroethylene (PTFE) based material compounded with carbon additive. Recommended for dynamic applications, in particular dry-running air and gas). Color: black	-60 to +300 (-76 to +572)	A	7 x 10 <sup>2</sup> Gray (7 x 10 <sup>4</sup> Rads)
T25	High-grade formulation of virgin polytetrafluoroethylene (PTFE) based material compounded with glass fibers and lubricant additives. Excellent wear and low friction characteristics for lubricated rotary applications. Color: black / grey	-60 to +300 (-76 to +572)	A	7 x 10 <sup>2</sup> Gray (7 x 10 <sup>4</sup> Rads)
T40 / MF4*	High-grade formulation of virgin polytetrafluoroethylene (PTFE) based material compounded with carbon fiber additive. Excellent wear and low friction characteristics. Suited to reciprocating and rotary applications. Suitable for use in media with poor lubricating properties and for dry-running situations. MF4, a specialized grade of Turcon® T40 compound for food contact service. Color: black / grey	-60 to +300 (-76 to +572)	A	7 x 10 <sup>2</sup> Gray (7 x 10 <sup>4</sup> Rads)
M79	High grade formulation of virgin polytetrafluoroethylene (PTFE) based material compounded with an aromatic polymer and lubricant. Especially suited for low pressure rotary applications and running against soft surfaces. Color: black / grey	-100 to +300 (-148 to +572)	A	7 x 10 <sup>2</sup> Gray (7 x 10 <sup>4</sup> Rads)
MF6*	High grade formulation of virgin polytetrafluoroethylene (PTFE) based material compounded with an aromatic polymer. Especially suited for low pressure rotary applications and running against soft surfaces. MF6 for food contact service. Color: beige	-60 to +260 (-76 to +500)	A	7 x 10 <sup>2</sup> Gray (7 x 10 <sup>4</sup> Rads)
Z48	TPE (thermoplastic elastomer) for tight sealing with long wear life in applications without high temperatures or corrosive chemicals. Color: black	-62 to +135 (-80 to +275)	C	1.5 x 10 <sup>5</sup> Gray (1.5 x 10 <sup>7</sup> Rads)
Z80	UHMW Polyethylene. Excellent wear and abrasion resistance. Very good lubricity in water based media. Color: translucent white	-253 to +80 (-423 to +176)	B	1 x 10 <sup>5</sup> Gray (1 x 10 <sup>7</sup> Rads)

For temperatures above 500 °F (260 °C), please reference the Society of Plastics Industry's Safe Handling Guide.

\* MF grade materials have compliance to FDA, EU or Chinese GB standards. Contact your local Trelleborg Sealing Solutions marketing company for detailed compliance information.



## ■ Turcon® Seal Materials

Turcon® materials are high performance thermoplastics specifically developed for sealing applications. They are based on premium-grade PTFE fluoropolymer resins, with the properties of each compound achieved by the addition of fillers and special processing techniques.

Turcon® materials offer the following benefits:

### Low Coefficient of Friction

Friction is dependent on pressure, contact surface area, speed and lubrication. Turcon® materials have very good friction characteristics. For example, a coefficient of friction on steel mating surfaces of 0.04 can be achieved under lubricated and hydrodynamic conditions.

Turcon® materials do not adhere to their mating surfaces and show only a slight difference between static and dynamic friction, thus eliminating the danger of the stick-slip effect in dynamic applications.

### Chemical Compatibility

Turcon® materials are stable in all hydraulic fluids. Seal materials should be chosen to suit the lubricating properties of hydraulic media and the wear properties of seal and mating surfaces.

There is only a slight change in chemical properties of Turcon® materials, compared to chemically inert virgin PTFE, dependent on the type of filler material added.

### Temperature Range

Turcon® materials can be used at temperatures between -253 °C and +300 °C (-423 °F and +572 °F). The limits for low temperatures are dependent on seal design and the thermal contraction of the material. Special designs are available for sealing cryogenic fluids at temperatures below -200 °C (-328 °F).

General service temperature is limited to +300 °C (+572 °F). At temperatures above this, the seal materials begin to lose their strength and are subject to plastic deformation.

For temperatures above +260 °C (+500 °F), please reference the Society of the Plastics Industry's Safe Handling Guide.

### Temperature Cycling

Cyclical temperature fluctuations do not change the properties of Turcon® materials.

### High Surface Speeds

The mechanical properties of Turcon® materials mean they are excellent in dynamic applications, even under extreme loads.

Turcon® seals offer higher operational reliability than elastomer seals in dynamic situations, especially in dry starting or operating conditions, as they do not suffer from adhesion or heat generation. When the application is lubricated, seal life will be extended further.

### Wear Resistance

Wear resistance is dependent upon material fillers which influence the Turcon® material's mechanical and physical properties. Fillers in Turcon® include graphite, carbon, carbon fiber, glass fiber, molybdenum disulphide and other polymers. They can give increased resilience, improved wear resistance, reduced thermal expansion and extremely high resistance to abrasive wear.

### Aging

Turcon® materials remain unchanged over extended periods. They are practically non-aging and do not become brittle or degrade, even when subject to severe weathering from heat, light, water or salt spray.

### Radiation

Turcon® materials exhibit a low resistance to electron and gamma radiation and are not recommended for use in applications where the accumulated radiation doses exceed  $7 \times 10^2$  Gy ( $7 \times 10^4$  rad). For applications, subject to high radiation doses, special fluoropolymers such as ETFE and PCTFE or Turcon® materials should be selected.

### Other Properties

Some Turcon® materials have outstanding electrical properties, such as a low dielectric constant or a very high electric strength, even at elevated temperatures.

Physiologically safe Turcon® materials are available which meet the requirements of the German Federal Health Authority (BGA) and the FDA Regulation (Food and Drug Administration) No. 21 CFR, Part 177.

The water absorption of Turcon® materials is < 0.01%.





## ■ Zurcon® Seal Materials

### **Zurcon® Z80**

Zurcon® Z80 is a virgin Ultra High Molecular Weight Polyethylene, or UHMWPE. Because the water absorption of Zurcon® Z80 is zero, it is ideal for water service. Its abrasion resistance is five to ten times higher than PTFE, making it the material of choice in abrasive environments. As it is physiologically safe, it is also suitable for use in food and pharmaceutical processing.

The main characteristics of Zurcon® Z80 are:

#### **Low Friction**

The dry friction coefficient of Zurcon® Z80 is lower than most other materials though higher than many filled PTFE materials. Zurcon® Z80 forms a self-lubricating, non-stick surface.

#### **Chemical Compatibility**

Zurcon® Z80 is stable in all hydraulic fluids. It has a high resistance to acids, bases and aggressive media. The material has limited resistance to aromatic and halogenated hydrocarbons.

#### **Water Service**

Zurcon® Z80 is water repellent and does not swell in water. Its self-lubricating properties in water-based media are excellent, giving it significant advantage over many other materials including PTFE-based ones. This combined with its high strength and wear resistance means it has a long service life in aqueous solutions.

#### **Temperature Range**

Zurcon® Z80 has a maximum continuous operating temperature of +80 °C (+176 °F). Above this temperature its wear resistance and strength begins to decrease. In low-pressure applications it can be used at temperatures of +120 °C (+248 °F) for short periods and can be sterilized briefly at even higher temperatures. Its lowest operating temperature is -200 °C (-328 °F).

#### **Wear Resistance**

The abrasive wear resistance of Zurcon® Z80 is 5 to 10 times higher than that of PTFE based materials. It is therefore recommended in applications where seals are in contact with abrasive media such as paints, adhesives, salts, sludges, etc.

Zurcon® Z80 is also highly resistant to extrusion at high pressures.

#### **Radiation Resistance**

The radiation resistance of Zurcon® Z80 is significantly higher than that of PTFE based materials, maintaining good mechanical properties at radiation dosages of up to 100 kGy.



### **Zurcon® Z48 (TPE)**

Thermoplastic elastomer (TPE) materials combine several of the most desirable features of high performance elastomers and flexible plastics. They have exceptional toughness and resilience, with high resistance to creep, impact and fatigue. The premium grades used in the Variseal® are fully machinable as well as injection moldable and have the following notable properties.

#### **Sealing ability**

TPE conforms well to mating surfaces and, when energized by a spring load, has very good resilience making it an excellent sealing material with very low leakage rates.

#### **Friction**

The coefficient of friction of a typical TPE material ranges from 0.30 to 0.60, depending on the mating surface finish and other service conditions. It is not normally recommended for dry service except at very slow speeds due to concerns about heat generation leading to material degradation.

In lubricated service conditions the speed rating is greatly increased and TPE materials may then be considered for use in moderate to high speed reciprocating applications, or in slow to moderate speed rotary service.

#### **Wear and extrusion resistance**

TPE blends have excellent wear resistance in well lubricated service where heat generation is kept to a minimum. It is especially long lasting in low to moderate speeds in reciprocating service at low or high pressures. TPE is also noted for its excellent extrusion resistance in high pressure applications up to 68.9 MPa (10,000 psi).

#### **Temperature range**

TPE materials exhibit excellent physical properties over a broad temperature range. Various grades are flexible to -62 °C (-80 °F), and retain good physical properties at temperatures to +135 °C (+275 °F). At temperatures above +135 °C (+275 °F), however, TPE is only recommended in short term service because it is subject to heat aging and embrittlement.

#### **Compatibility**

Thermoplastic elastomers resist deterioration from many industrial chemicals, oils and solvents. They are resistant to swelling in oils and aliphatic and aromatic hydrocarbons at moderate temperatures. TPE is limited in its compatibility with hot water applications. For example, in long-term service sealing water at +71 °C (+160 °F), TPE loses much of its resilience and experiences a significant drop in tensile strength.



## Spring Types and Materials

A metal spring is incorporated into Turcon® Variseal® to provide elasticity to the seal. This makes the seal permanently elastic, despite changes in operating temperature, pressure or chemicals processed. Each of the three spring types used in Variseal® has unique properties that give them their performance characteristics. The two most important properties of the spring, besides the corrosion resistance of the metal, are load value and deflection range. The spring load affects sealing ability, friction and the wear rate of the seal. The deflection range determines the ability of the Variseal® designs to take up wear and compensate for variations in gland dimensions.

### V-Spring

V-Spring is the standard spring type for Variseal® **M2**, Variseal® **M2S** and **Roto Variseal®**. It operates as a set of "cantilever beams", extending from an arc at the bottom of the spring. The shape of the spring causes the load to be focused on the front edge of the sealing lip, giving the seal a positive wiping action. The V-Spring has a moderate load and deflection range.

### Helical Spring

The Helical spring, used in Variseal® **H** and Variseal® **HF**, is made from a flat strip formed into a helical coil spring. It has a much higher unit load and a shorter deflection range than the other spring types. Therefore, it is best suited to static or slow dynamic applications, where friction and wear are not the key issues. Variseal® **H** and Variseal® **HF** are the best choices for vacuum, gas and low temperature applications.

### Slantcoil® Spring

The Slantcoil® spring used in Variseal® **W2** consists of round wire formed into slanted coils and has a relatively constant load over a wide deflection range. This allows accurate control of friction during the working life of the seal. Its unique design makes it almost impossible to damage the spring by excessive deformation of the seal.

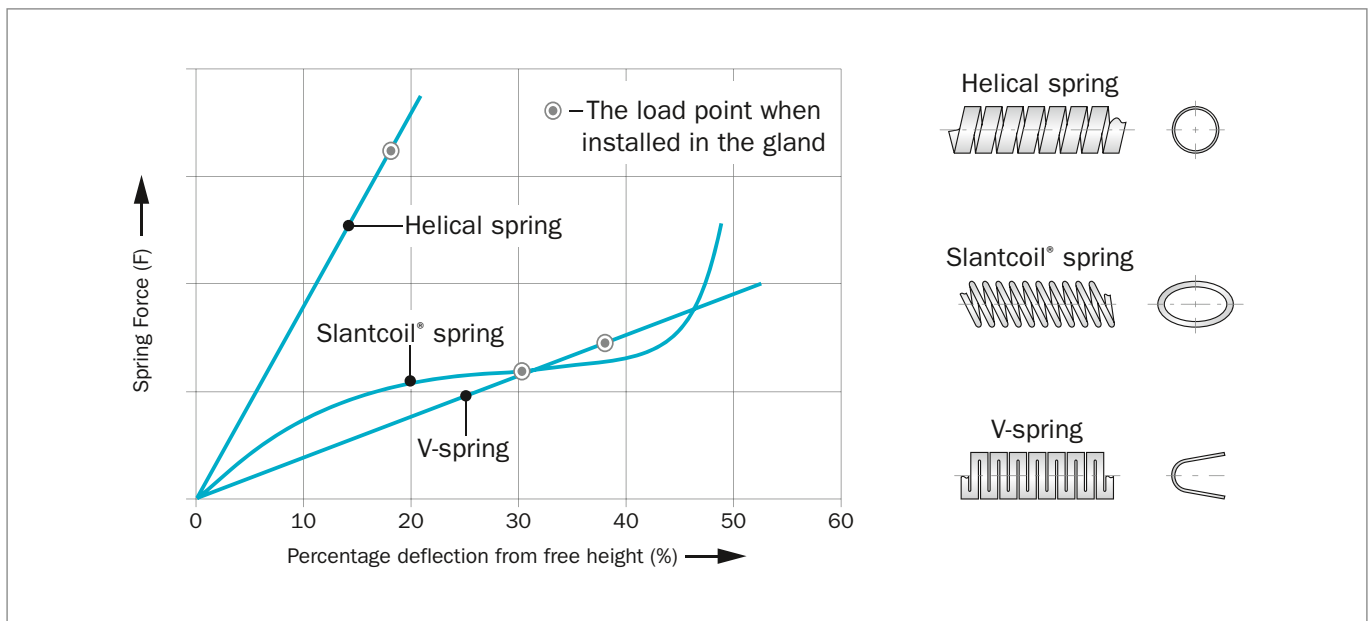

Figure 3: Comparison of load curves for the three spring types



### Spring Materials

The standard spring material for Turcon® Variseal® is stainless steel (spring code S). Two further materials are available for the specific applications, as detailed in the table below.

**Table 4: Spring Materials Selection Guide**

Media	Spring materials	Spring order code
<b>For General use e.g.</b> Oil Grease Air Water, steam Solvents Food, drugs Gas	<b>Stainless steel</b> DIN Mat No. 1.4310/1.4319 AISI 301/302 UNS 30100	S (Standard spring material)
<b>For use in corrosive media e.g.</b> Acids Caustics Seawater	<b>Hastelloy® C-276</b> DIN Mat No. 2.4819 UNS N10276	H
<b>For petrochemical use e.g.</b> Crude oil Sour gas	<b>Elgiloy® 1)</b> DIN Mat No. 2.4711 UNSR30003	E

® Hastelloy is a registered trademark of Haynes International, Inc.  
 ® Elgiloy is a registered trademark of the Elgiloy Specialty Metals  
 Alternative brand may be used.  
 1) NACE-approval

## ■ Quality Criteria

Seals and bearings manufactured by Trelleborg Sealing Solutions are continuously monitored according to strict quality standards from material supply to delivery of finished parts.

Production plants are certified to international standards such as EN ISO 9001, covering quality control and management of purchasing, production and marketing functions.

All testing of materials and products is performed in accordance with accepted test standards and specifications. Our sealing materials are produced free of chlorofluorinated hydrocarbons and carcinogenic elements.

The tenth digit of our Trelleborg Sealing Solutions part number defines the quality characteristics of the part. A hyphen indicates compliance with standard quality criteria outlined in this catalog. Customer-specific requirements are indicated by a different symbol. Customers who require special quality criteria should contact their local Trelleborg Sealing Solutions marketing company for assistance.



## ■ Hardware Design Considerations

The best way to obtain optimum Variseal® performance is to plan ahead - during the design phase of your product. The initial phase should bring into alignment the three factors having the greatest impact on seal performance - the hardware design, the service conditions, and the seal design.

Design issues such as gland style, mating surface hardness and surface finish, and dynamic alignment should be reviewed and adjusted to work with the intended service conditions and to suit the selected seal design. The information in this section is primarily intended as a guide for the design of new hardware, however, it is completely applicable to the task of reviewing or modifying existing hardware to improve seal performance.

A primary goal in selecting a basic gland style is to be able to install the seals without damaging them. The first half of this Section describes the various gland types and installation procedures.

Once the issue of seal installation has been addressed, the goal of hardware design is then to improve seal performance in terms of wear life, leakage rate, friction, and so on.

### Basic Gland Styles

There are three basic gland styles to be considered - split, stepped, and solid (see Figure 4). The gland required for a radial Variseal® is similar to an O-Ring gland with one major difference - an O-Ring gland has a typically solid (one piece) construction with a full gland wall on each side. Since the Variseal® is made from polymers, which do not stretch like elastomers, installation in such glands can be difficult - or in many cases impossible. To install the Variseal® easily requires either the split gland or the stepped gland. The solid groove is sometimes used, but only when no other option exists and then only with certain diameter restrictions described later in the Groove Design section.

When retrofitting an existing solid gland for which the hardware cannot be modified, the solution might involve a special seal design or installation tools. Our engineering and technical support personnel are always available to assist you with these situations. To discuss your application, please contact your local Variseal® representative.

The basic gland styles shown above are described in further detail on the following pages.

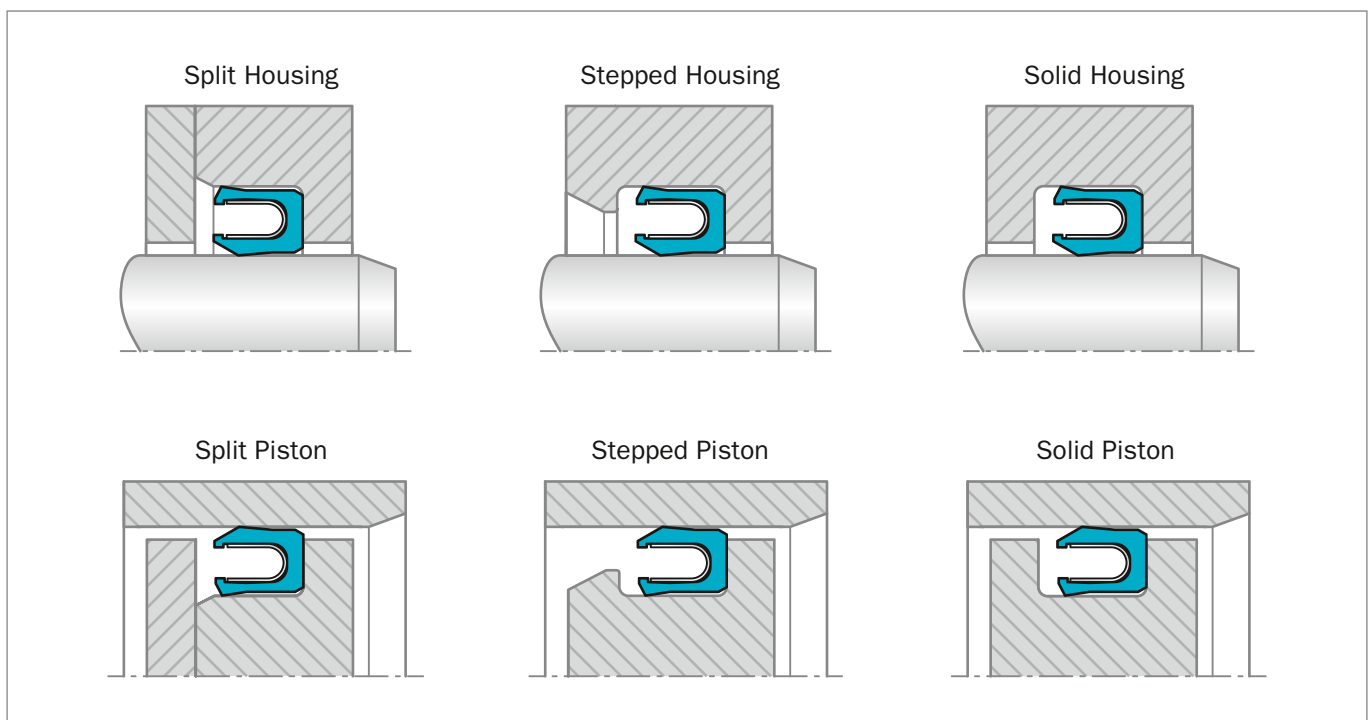

Figure 4: Basic Radial Gland Styles



## ■ Basic Gland Types

### Split Gland

The best way to obtain optimum Variseal® performance is to plan a Split gland. A split gland designates hardware that is separated or “split” into two pieces to allow assembly without deforming the seal. The split gland minimizes potential damage to the seal. Its advantages include:

- No stretching of the seal
- Repeated installation without damage
- No special installation tools

The disadvantage is that a second piece such as an end plate is required to retain the seal. This might also involve a third piece such as a bolt to secure the end plate.

### Stepped Glands

A stepped gland has a small “step” or ledge, which retains the seal. The step height is small, so that the seal can be pushed past it easily. See the Groove Design section for recommended step heights. In most cases, no special tooling or installation procedures are required.

The stepped gland has the advantage of being a simpler configuration (with fewer pieces than the split gland) while maintaining relative ease of assembly. The stepped gland is an excellent configuration for piston seal applications.

### Solid Glands

Because the Variseal® does not stretch like an elastomeric O-ring, it is difficult to install in a solid radial groove. This gland is not recommended for new designs, but is often encountered when retrofitting existing glands. It can be used in those cases where the ratio of seal diameter to seal cross-section is large enough.

### Face Seal Glands

Face seal glands for the Variseal® are typically the same as O-ring glands, with no problems installing the seal. One advantage of the Variseal® in face seal applications is that it does not require a full gland wall on the pressure side of the seal.

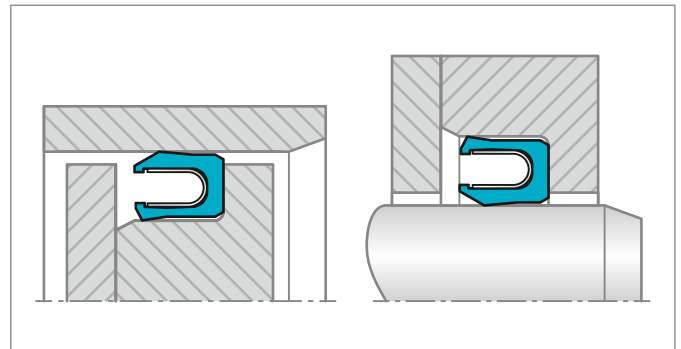

Figure 5: Split or “two piece” Glands

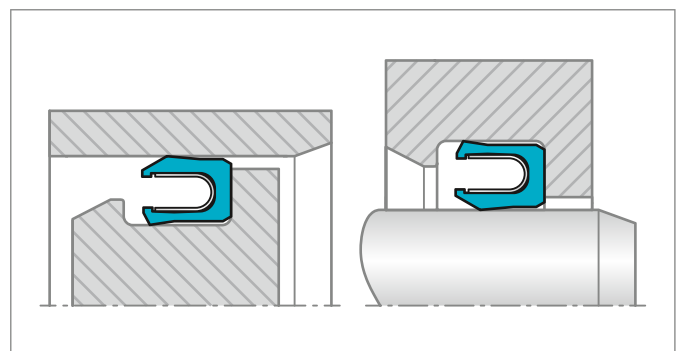

Figure 6: Stepped Glands

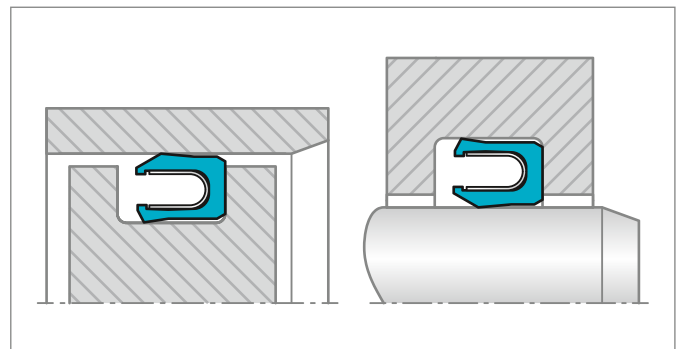

Figure 7: Solid or “one piece” Glands

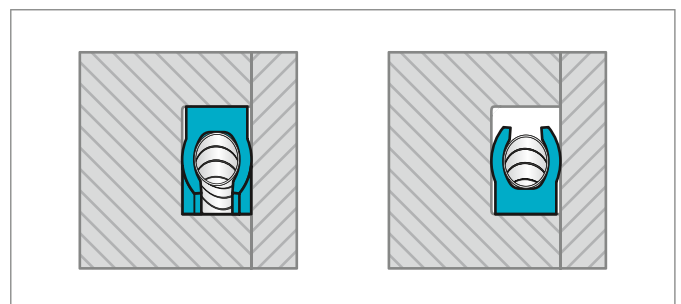

Figure 8: Face Seal Glands



## ■ Preventing Seal Damage

Taking a few reasonable precautions to prevent scratching the seals will increase seal life and reliability. To prevent damage during installation, consider the following aspects of hardware design:

- The installation path should be kept free of nicks, burrs, scratches, or any sharp edge that could damage the seal.
  - Any tool used to install seals should be free of sharp edges. Screw drivers are especially notorious for damaging seals and should not be used to handle the Variseal®.
  - A lead-in chamfer on the end of the rod or bore helps during installation. The proper chamfer dimensions are given in Groove design pages found later in this section. This is especially important where seals are to be installed face first (spring cavity side first) into the gland.
  - When seals must be installed across ports, bevel and smooth the edges of the ports.
  - Designate splines or keyways to fall on a smaller diameter than the sealing surface or use a protective sleeve to cover them during installation as illustrated in Figure 9 below.
- The Variseal® is typically installed without the aid of heat or lubrication. In situations where heat is required to soften and expand the seal, submerge them for a few minutes in very hot oil or water.
  - Application of a lubricant to surfaces of the seal and hardware reduces the force required to push the seal into a difficult gland such as a solid O-Ring groove.
  - During handling, place the seals where they will not be crushed by tools or other items. It is advisable to leave the seals in their shipping containers until just before installation.
  - Avoid glands which require bending the seals during installation. When seals must be stretched or compressed into a difficult gland, be sure to use the recommended tooling to resize the seals.
  - Do not sideload the seals any more than is necessary. Avoid gland situations where a heavy rod or piston rests against one side of the seal.

If you feel that your application poses an especially difficult problem with installation, contact the your local Variseal® representative.

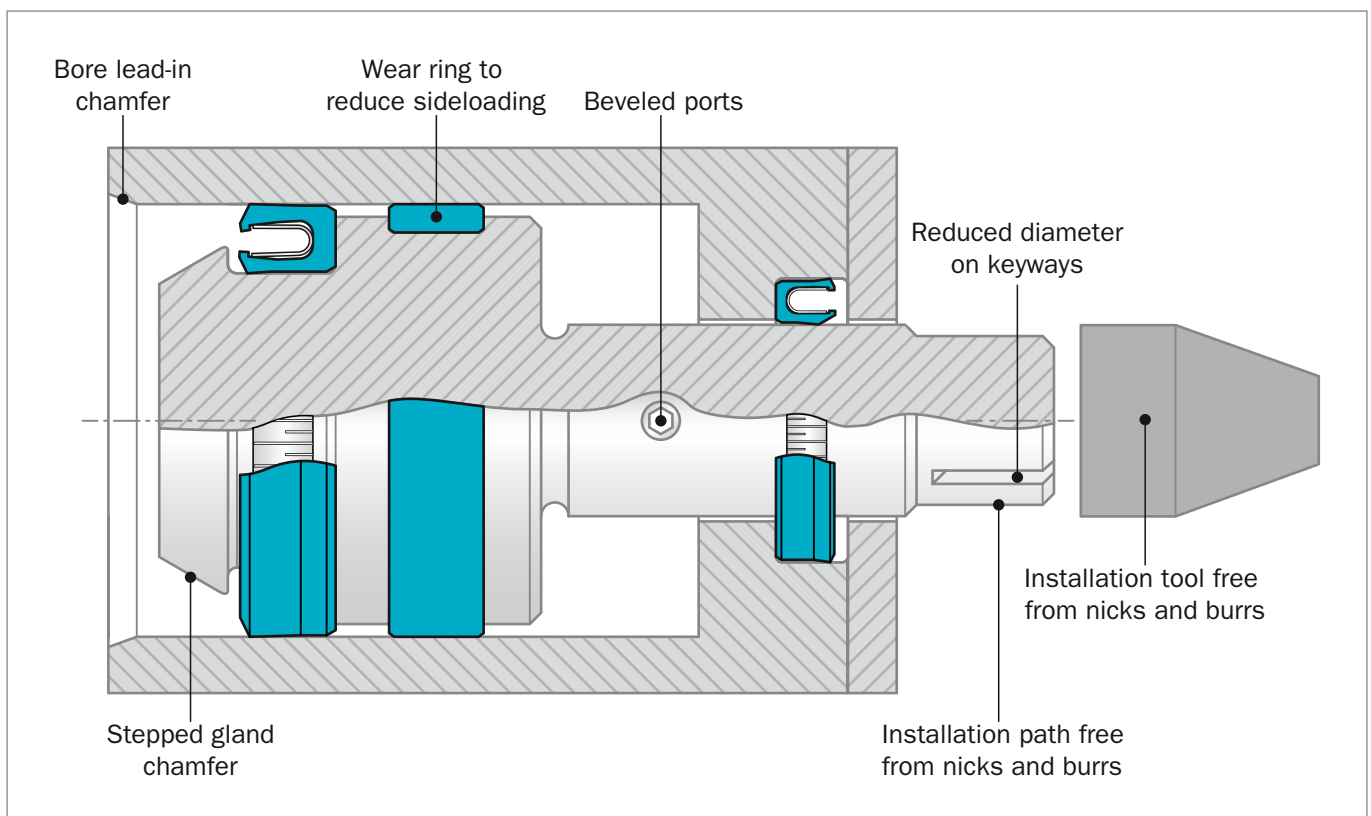

Figure 9: Methods of Hardware Design to Prevent Seal Damages



## ■ Groove Design – Metric

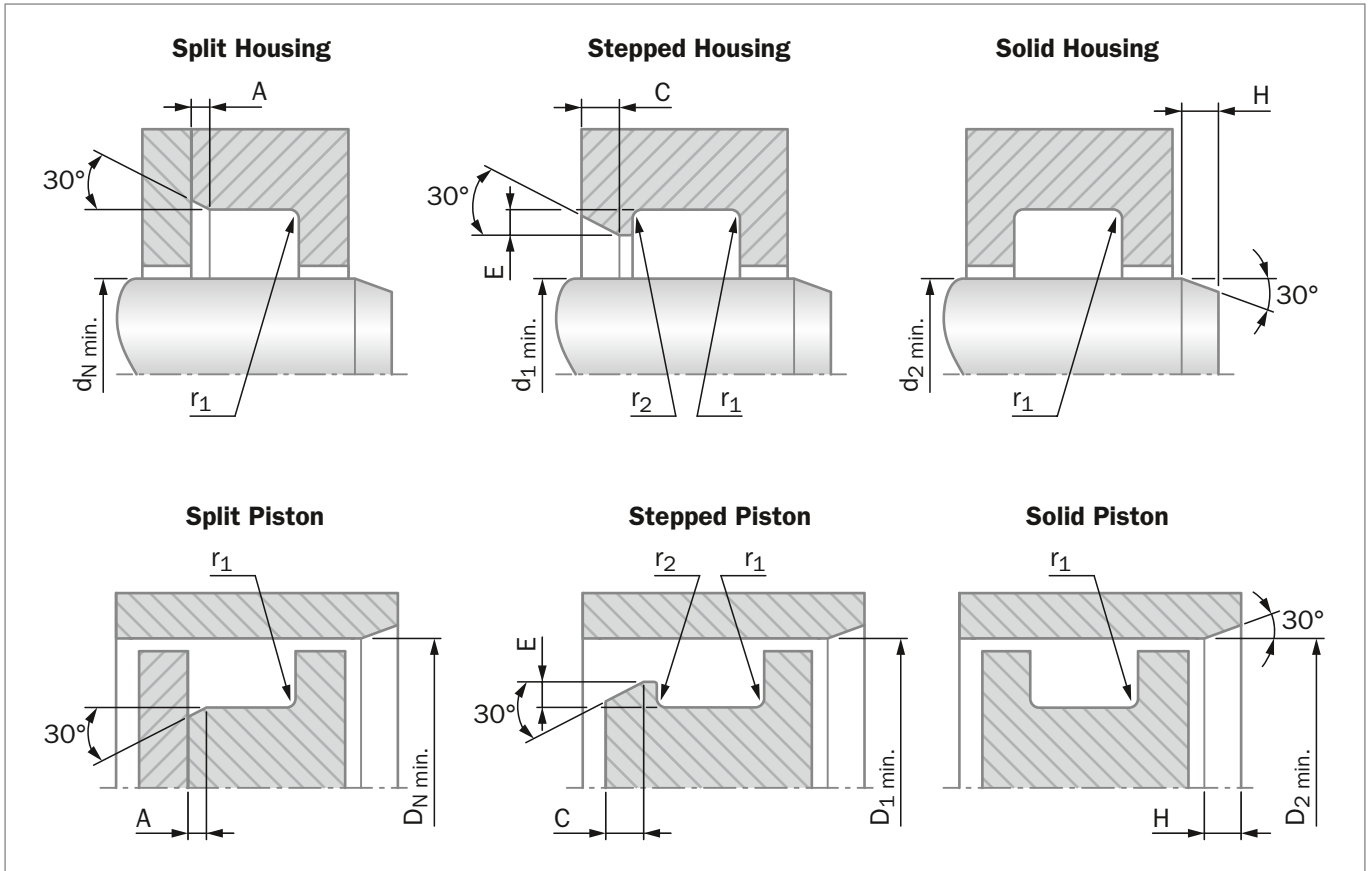

Figure 10: Variseal Groove Configurations

Installation lead-in chamfers and steps to include blend radii and are to be polished.

Table 5: Dimensions for Groove Designs – Metric

Series	Rod / Piston Groove Dimensions					
	A Chamfer	$r_1$ Maximum Radius	C Minimum Chamfer	$r_2$ Maximum Radius	E Minimum Step Height	H Minimum Chamfer
000	0.25 / 0.38	0.25	0.70	0.13	0.40	1.20
100	0.38 / 0.51	0.38	1.10	0.13	0.60	1.50
200	0.38 / 0.51	0.38	1.25	0.18	0.70	2.50
300	0.51 / 0.69	0.38	1.40	0.25	0.80	4.50
400	0.51 / 0.69	0.51	1.60	0.25	0.90	6.00
500	0.76 / 1.02	0.51	2.60	0.38	1.50	11.00





Table 6: Groove Design for Rod – Metric

Series	Rod Diameter Recommendations				
	Split Groove Ø d <sub>N</sub> Minimum Type M2, M2S, W2, H	Stepped Groove Ø d <sub>1</sub> Minimum Type M2, M2S, W2, H	Solid Groove Ø d <sub>2</sub> Minimum		
			Type M2, M2S	Type W2	Type H
000	3.00	20.00	31.75	25.40	25.40
100	6.00	30.00	69.85	63.50	63.50
200	10.00	35.00	111.13	107.95	107.95
300	20.00	40.00	298.45	228.60	228.60
400	35.00	45.00	495.30	400.05	400.05
500	80.00	80.00	762.00	635.00	635.00

Table 7: Groove Design for Piston – Metric

Series	Piston Diameter Recommendations				
	Split Groove Ø D <sub>N</sub> Minimum Type M2, M2S, W2, H	Stepped Groove Ø D <sub>1</sub> Minimum Type M2, M2S, W2, H	Solid Groove Ø D <sub>2</sub> Minimum		
			Type M2, M2S	Type W2	Type H
000	6.00	11.50	34.93	19.05	19.05
100	10.00	17.50	50.80	28.58	28.58
200	16.00	20.00	69.85	44.45	44.45
300	28.00	28.00	104.78	60.33	60.33
400	45.00	45.00	139.70	95.25	95.25
500	100.00	100.00	254.00	203.20	203.20



## ■ Groove Design – Inch

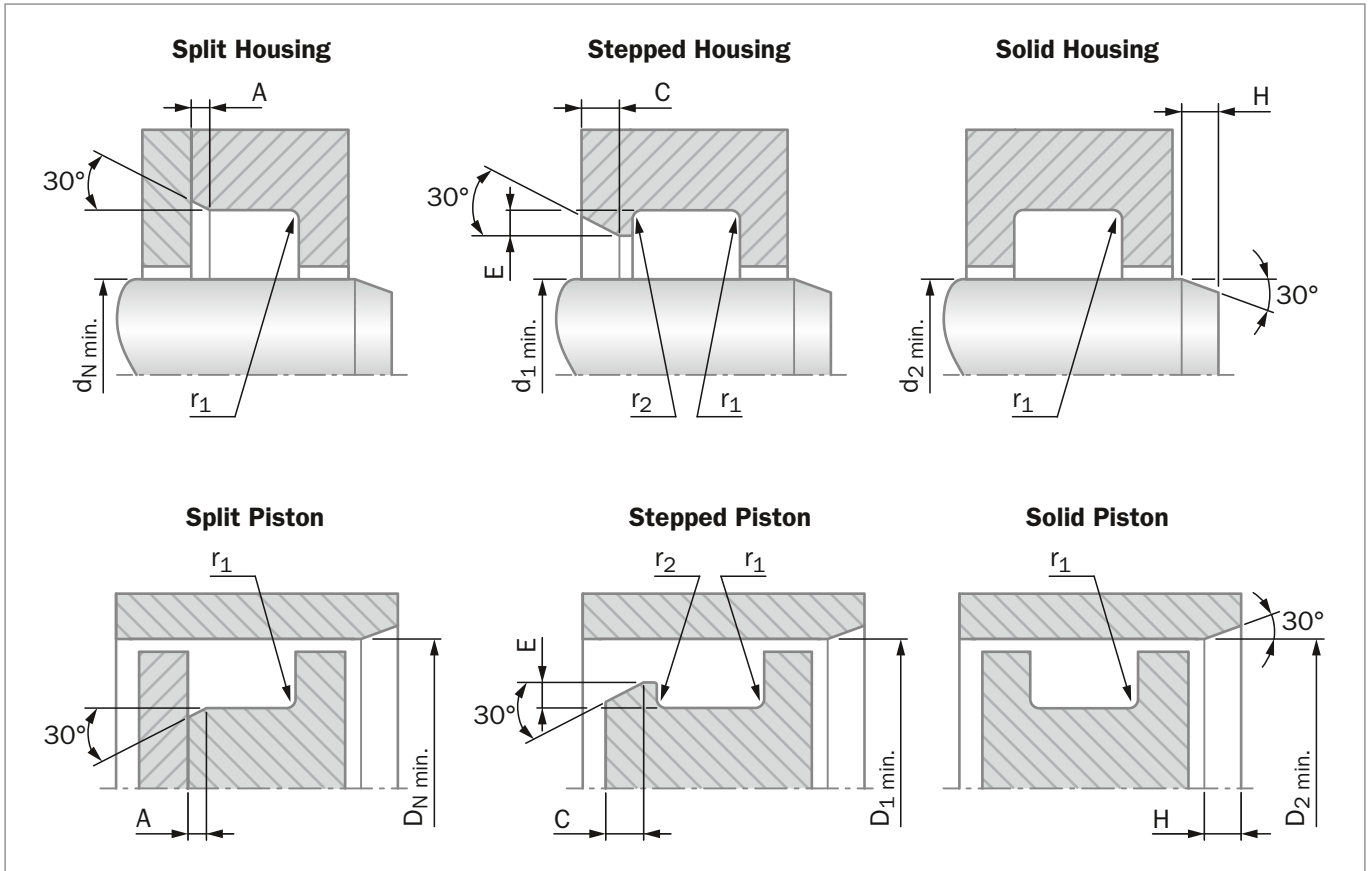

Figure 11: Variseal Groove Configurations

Installation lead-in chamfers and steps to include blend radii and are to be polished.

**Table 8: Dimensions for Groove Designs – Inch**

Series	Rod / Piston Groove Dimensions					
	A Chamfer	r <sub>1</sub> Maximum Radius	C Minimum Chamfer	r <sub>2</sub> Maximum Radius	E Minimum Step Height	H Minimum Chamfer
000	0.010 / 0.015	0.010	0.028	0.005	0.016	0.047
100	0.015 / 0.020	0.015	0.043	0.005	0.024	0.059
200	0.015 / 0.020	0.015	0.050	0.007	0.028	0.098
300	0.020 / 0.027	0.015	0.055	0.010	0.031	0.177
400	0.020 / 0.027	0.020	0.063	0.010	0.035	0.236
500	0.030 / 0.040	0.020	0.102	0.015	0.059	0.433



Table 9: Groove Design for Rod – Inch

Series	Rod Diameter Recommendations				
	Split Groove Ø d <sub>N</sub> Minimum	Stepped Groove Ø d <sub>1</sub> Minimum	Solid Groove Ø d <sub>2</sub> Minimum		
			Type M2, M2S, W2, H	Type M2, M2S	Type W2
	000	0.118	0.787	1.250	1.000
100	0.236	1.181	2.750	2.500	2.500
200	0.394	1.378	4.375	4.250	4.250
300	0.787	1.575	11.750	9.000	9.000
400	1.378	1.772	19.500	15.750	15.750
500	3.150	3.150	30.000	25.000	25.000

Table 10: Groove Design for Piston – Inch

Series	Piston Diameter Recommendations				
	Split Groove Ø D <sub>N</sub> Minimum	Stepped Groove Ø D <sub>1</sub> Minimum	Solid Groove Ø D <sub>2</sub> Minimum		
			Type M2, M2S, W2, H	Type M2, M2S	Type W2
	000	0.236	0.453	1.375	0.750
100	0.394	0.689	2.000	1.125	1.125
200	0.630	0.787	2.750	1.750	1.75
300	1.102	1.102	4.125	2.675	2.375
400	1.772	1.772	5.500	3.750	3.750
500	3.937	3.937	10.000	8.000	8.000



## ■ Surface Roughness

The functional reliability and service life of a sealing system is dependent upon the quality and surface finish of the mating surface to be sealed.

Scores, scratches, pores, concentric or spiral machining marks are not permitted. Higher demands must be made on the surface finish of dynamic mating surfaces than of static mating surfaces (Table 11).

The characteristics most frequently used to describe the surface micro finish Ra, Rz and Rmax are defined in DIN 4762/ISO 4287/1. These characteristics are not sufficient for assessing the suitability of a surface finish in seal engineering.

The material contact area Mr (previously percentage contact area tp) in accordance with ISO 4287/1, must also be taken into consideration. The significance of this surface specification is illustrated in Figure 12. It shows that specification of Ra and Rz does not describe the profile form accurately enough. The material contact area Mr is essential to assess surface suitability, as the specific profile form determines this parameter. This in turn is directly dependent on the machining process employed.

Figure 13 shows a printout from a commercially available surface measuring instrument. It contains all the information necessary to permit a precise description of a surface finish. Trelleborg Sealing Solutions recommends that the following surface finishes be observed:

**Table 11: Surface Roughness**

Recommended Maximum Surface Roughness µm and µin						
Media	Rotary Surface <sup>1)</sup>		Reciprocating Surface		Static Groove Surface	
Cryogenic and low molecular gases, hydrogen, helium, freon, oxygen, nitrogen	Rmax = 1.0 µm Rz = 0.63 µm Ra = 0.1 µm	Rmax = 39 µin Rz = 25 µin Ra = 4 µin	Rmax = 2.5 µm Rz = 1.6 µm Ra = 0.2 µm	Rmax = 98 µin Rz = 63 µin Ra = 8 µin	Rmax = 3.5 µm Rz = 2.2 µm Ra = 0.3 µm	Rmax = 138 µin Rz = 87 µin Ra = 12 µin
Low viscosity fluids water, alcohols, hydrazine, gaseous nitrogen, natural gas, skydrol, air	Rmax = 2.5 µm Rz = 1.6 µm Ra = 0.2 µm	Rmax = 98 µin Rz = 63 µin Ra = 8 µin	Rmax = 3.5 µm Rz = 2.2 µm Ra = 0.3 µm	Rmax = 138 µin Rz = 87 µin Ra = 12 µin	Rmax = 5.0 µm Rz = 3.5 µm Ra = 0.6 µm	Rmax = 197 µin Rz = 138 µin Ra = 24 µin
High viscosity fluids hydraulic oils, crude oil, gear oil, sealants, glue, milk products	Rmax = 2.5 µm Rz = 1.6 µm Ra = 0.2 µm	Rmax = 98 µin Rz = 63 µin Ra = 8 µin	Rmax = 4.0 µm Rz = 2.5 µm Ra = 0.4 µm	Rmax = 157 µin Rz = 98 µin Ra = 16 µin	Rmax = 6.5 µm Rz = 5.0 µm Ra = 0.8 µm	Rmax = 256 µin Rz = 197 µin Ra = 32 µin

1) The sealing surface must be free from spiral grooves.

The material contact area Mr should be approximately 50% to 70%, determined at a cut depth  $c = 0.25 \times Rz$ , relative to a reference line of  $C_{ref}$ . 5%.

Figure 12 shows two surface profiles, both of which give nearly the same values for Rz in the test procedure. The difference shows up when the material contact areas are compared. These show that the upper profile with Mr = 70% has the better seal to mating surface ratio.

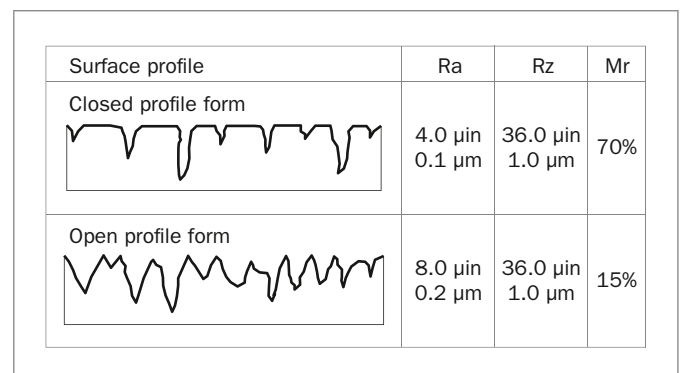

Figure 12: Profile forms of surfaces



## TEST PROCEDURE

Depending on the current test program, the test procedure can contain the following elements:

- Company text (1)
- Workpiece text (2)
- Program number, measurement number, test conditions (3)
- Characteristics (4)
- Material contact area (5)
- Characteristic curves (6)
- Profile curve (7)

1 Trelleborg Sealing Solutions  
Perthometer S3P V2.1

2 Obj.: Piston rod  
Name: GJ  
Date.: 19.05.93 09:40

3 Program 6  
Measuring 2  
T1 RFHTB-50 50 1

LT 5.600 mm

LM 4.000 mm

VB 25.00  $\mu\text{m}$

4 LC GS 0.800 mm

RA 0.079  $\mu\text{m}$

RZ 0.775  $\mu\text{m}$

RMAX 1.215  $\mu\text{m}$

RK 0.221  $\mu\text{m}$

RPK 0.089  $\mu\text{m}$

RVK 0.131  $\mu\text{m}$

LC GS 0.800 mm

5 R	MR ( 0.125 5)	0%
R	MR ( 0.000 5)	5% C ref
R	MR (- 0.050 5)	13%
R	MR (- 0.100 5)	30%
R	MR (- 0.150 5)	52%
R	MR (- 0.200 5)	73%
R	MR (- 0.250 5)	87%
R	MR (- 0.300 5)	95%
R	MR (- 0.350 5)	98%
R	MR (- 0.400 5)	99%
R	MR (- 0.450 5)	99%
R	MR (- 0.500 5)	100%
R	MR (- 0.550 5)	100%
R	MR (- 0.600 5)	100%

### Evaluation of the test procedure

- a) The values for  $R_a$ ,  $R_z$  and  $R_{max}$  correspond to our recommendations.
- b) The cut length is calculated with  $c = 0.25 \cdot R_z = 0.25 \cdot 0.7752 =$  approximately 0.200 with a material contact area  $M_r =$  approximately 70%
- c) The ratio  $R_z/R_a = 9.81$  indicates a closed profile.

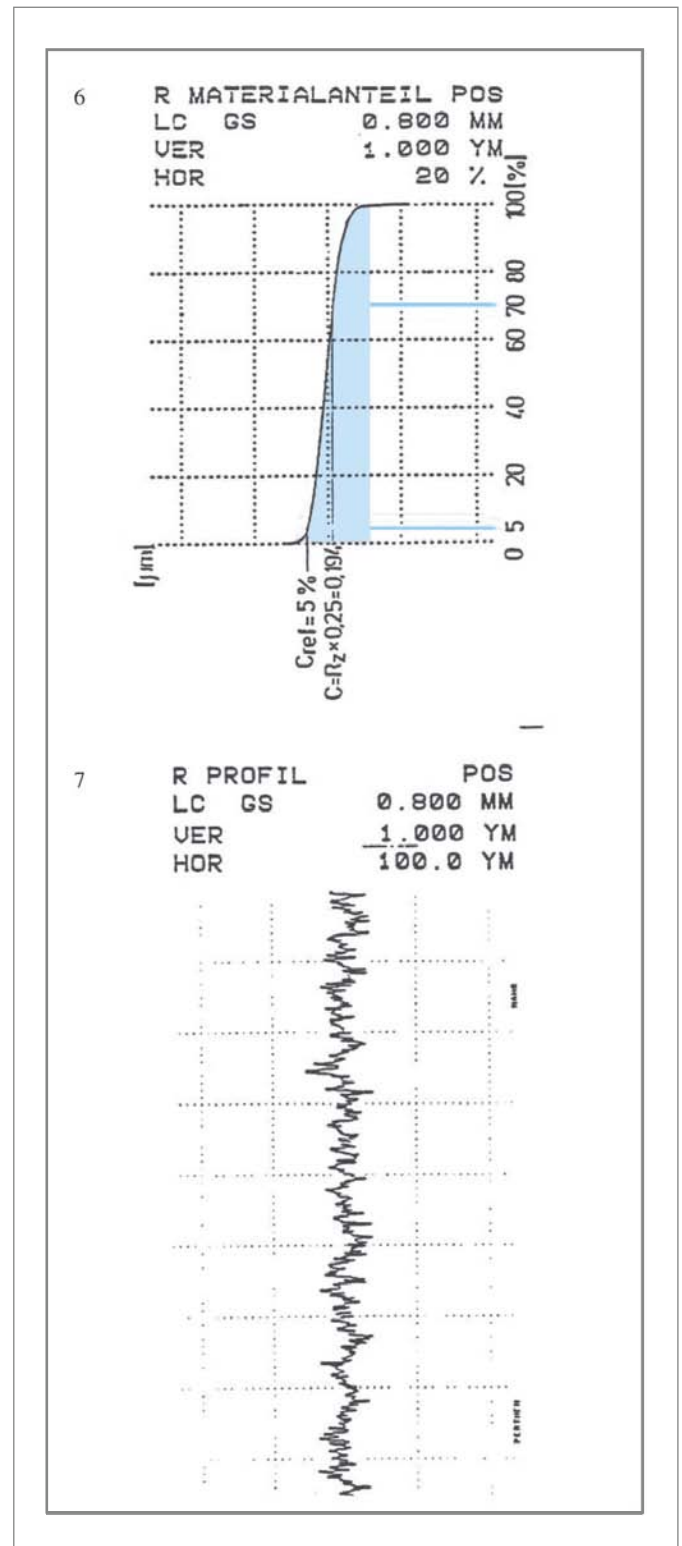

Figure 13: Measurement printout



## Turcon® Variseal® M2

### DESCRIPTION

Turcon® Variseal® M2 is a single acting seal consisting of a U-shaped jacket and a V-shaped corrosion resistant spring. Variseal® M2 has an asymmetric seal profile. The optimized front angle offers good leakage control, reduced friction and long service life.

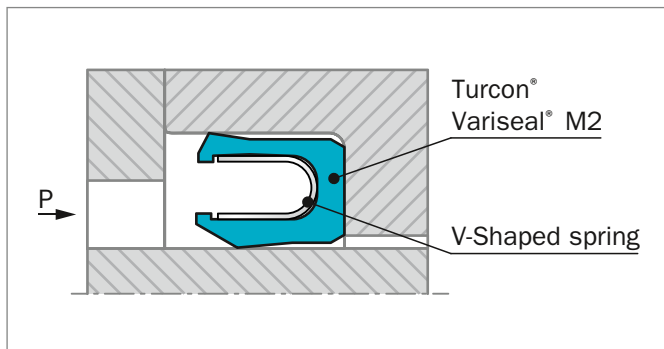

Figure 14: Turcon® Variseal® M2

### AREAS OF APPLICATION

- Hydraulic components, e.g. cylinders, valves, pumps, etc.
- Chemical processing equipment
- Pharmaceutical processing
- Food and beverage processing
- Spindle seals for machine tools
- Pneumatics, cylinders and valves

### ADVANTAGES

- Suitable for reciprocating and rotary applications
- Low coefficient of friction
- Stick-slip free operating
- High abrasion resistance
- Dimensionally stable
- Resistant to most fluids, chemicals and gases
- Withstands rapid changes in temperature
- No vulcanizing between seal and hardware
- Excellent resistance to aging
- Can be sterilized
- Available in Hi-Clean version
- Interchangeable with O-Ring and Back-up Ring combinations to AS4716 and ISO 6194

### TECHNICAL DATA

<b>Operating pressure:</b>	Maximum dynamic load: 20 MPa / 2,900 psi Maximum static load: 40 MPa / 5,800 psi (207 MPa / 30,000 psi with back-up ring)
<b>Speed:</b>	Reciprocating up to 15 m/s / 3,000 fpm Rotating up to 1.27 m/s / 240 fpm
<b>Operating temperature:</b>	-70 °C to +300 °C / -94 °F to +572 °F Special Turcon® and Zurcon® materials as well as alternative spring materials are available for applications outside this temperature range.
<b>Media compatibility:</b>	Virtually all fluids, chemicals and gases

### IMPORTANT NOTE

The above data are maximum values and cannot be used at the same time. e.g. the maximum operating speed depends on material type, pressure, temperature and gap value.

Temperature range also dependent on media.



## Turcon® Variseal® M2S

### DESCRIPTION

Turcon® Variseal® **M2S** is a single acting seal consisting of a U-shaped jacket and a V-shaped corrosion resistant spring. Variseal® M2S has an asymmetric seal profile. The dynamic lip is optimized, offering long service life and a good scraping ability even in media with high viscosity.

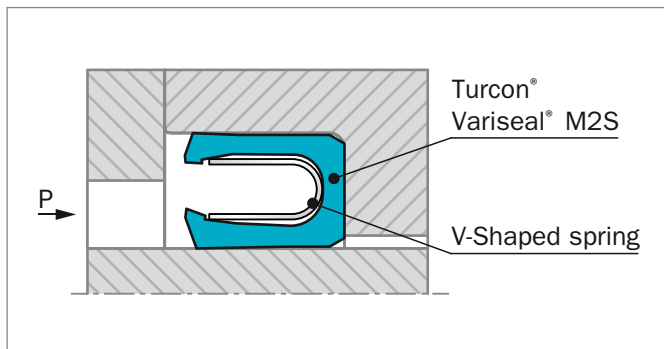

Figure 15: Turcon® Variseal® M2S

### AREAS OF APPLICATION

- Hydraulic components with highly viscous media
- Food processing, for example bottling plants for dairy and food products
- Pharmaceutical and chemical industries
- Processing of sealing compounds, adhesives, pastes, etc.
- Media with particle ingress

### ADVANTAGES

- Suitable for reciprocating and light duty rotary movement
- Excellent scraping ability
- High abrasion resistance
- Dimensionally stable
- Resistant to most fluids and chemicals
- Excellent resistance to aging
- Available in Hi-Clean version
- Interchangeable with O-Ring and Back-up Ring in most cases

### TECHNICAL DATA

<b>Operating pressure:</b>	Maximum dynamic load: 20 MPa / 2,900 psi Maximum static load: 40 MPa / 5,800 psi (207 MPa / 30,000 psi with custom designs)
<b>Speed:</b>	Reciprocating up to 15 m/s / 3,000 fpm Rotating up to 1.27 m/s / 250 fpm
<b>Operating temperature:</b>	-70 °C to +300 °C / -94 °F to +572 °F Special Turcon® and Zurcon® materials as well as alternative spring materials are available for applications outside this temperature range.
<b>Media compatibility:</b>	Fluids of medium to high viscosity or containing hard particles

### IMPORTANT NOTE

The above data are maximum values and cannot be used at the same time. e.g. the maximum operating speed depends on material type, pressure, temperature and gap value.  
Temperature range also dependent on media.



## Turcon® Variseal® W2

### DESCRIPTION

Turcon® Variseal® W2 is a single acting seal consisting of a U-shaped jacket and a corrosion resistant Slantcoil® spring. The Slantcoil® spring in the Variseal® W2 provides an almost constant load irrespective of hardware tolerances, eccentricity and seal wear.

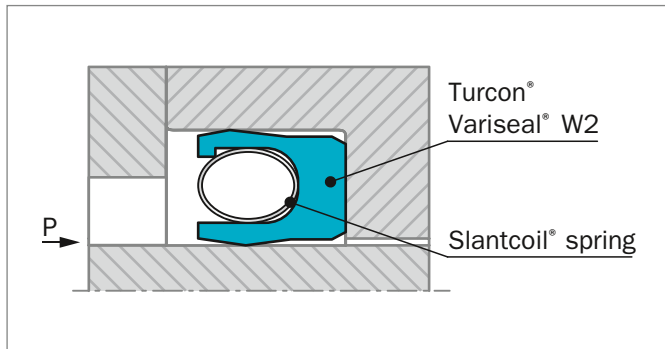

Figure 16: Turcon® Variseal® W2

### AREAS OF APPLICATION

- Hydraulic or pneumatic measuring instruments
- Servo valves, pressure switches
- Electronic equipment
- Laboratory apparatus

### ADVANTAGES

- Suitable for reciprocating and light duty rotary movement
- Constant initial squeeze of spring over a large control area
- Interchangeable with O-Ring and Back-up Ring in most cases

### TECHNICAL DATA

<b>Operating pressure:</b>	Maximum dynamic load: 20 MPa / 2,900 psi Maximum static load: 40 MPa / 5,800 psi (207 MPa / 30,000 psi with custom designs)
<b>Speed:</b>	Reciprocating up to 15 m/s / 3,000 fpm Rotating up to 1.27 m/s / 250 fpm
<b>Operating temperature:</b>	-70 °C to +300 °C -94 °F to +572 °F
<b>Media compatibility:</b>	Virtually all fluids, chemicals and gases

### IMPORTANT NOTE

The above data are maximum values and cannot be used at the same time. e.g. the maximum operating speed depends on material type, pressure, temperature and gap value.  
Temperature range also dependent on media.





## Turcon® Variseal® H

### DESCRIPTION

Turcon® Variseal® H is a single acting seal consisting of a U-shaped jacket and a helical wound corrosion resistant spring. The helical spring of Variseal® H has a high spring loading, which gives excellent sealing integrity at low pressure. Variseal® H is suitable for dynamic applications and ideal in static applications.

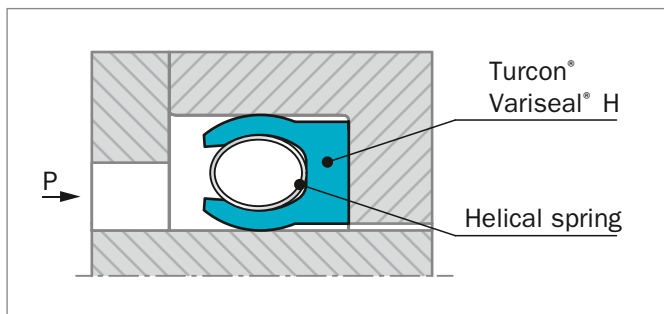

Figure 17: Turcon® Variseal® H

### AREAS OF APPLICATION

- Compressors
- Ball valves
- Construction - equipment and plant
- Chemical processing
- Crude oil and natural gas installations
- Cryogenic engineering
- Nuclear power engineering
- Vacuum applications
- Pivot joints
- Gas chromatographs

### ADVANTAGES

- High contact pressure
- Excellent sealing integrity in gas and fluid applications
- Withstands rapid changes in temperature
- Good sealing ability when surfaces are not ideal
- Excellent resistance to aging
- Interchangeable with O-Ring and Back-up Ring in most cases

### TECHNICAL DATA

<b>Operating pressure:</b>	Maximum dynamic load: 20 MPa / 2,900 psi Maximum static load 40 MPa / 5,800 psi (207 MPa / 30,000 psi with custom designs)
<b>Operating temperature:</b>	-100 °C to +200 °C / -148 °F to +392 °F
<b>Media compatibility:</b>	Virtually all fluids, chemicals and gases

### IMPORTANT NOTE

The above data are maximum values and cannot be used at the same time. e.g. the maximum operating speed depends on material type, pressure, temperature and gap value.

Temperature range also dependent on media.



## ■ Installation Recommendations for Rod Seals – Types M2, M2S, W2 and H – Metric

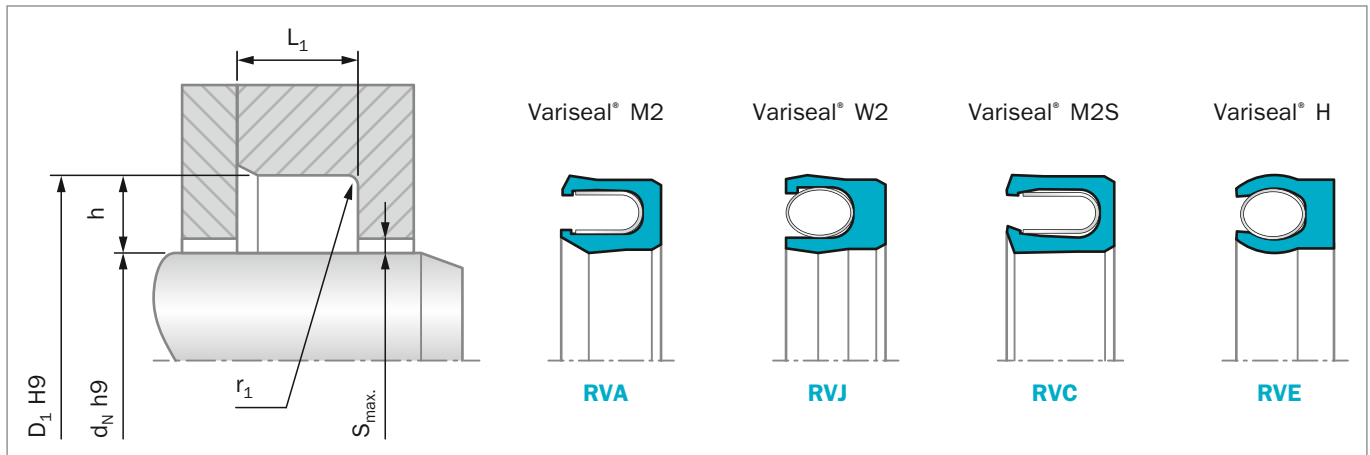

Figure 18: Installation Drawing

**Table 12: Installation Dimensions – Metric**

Series Number for Types				Rod Diameter $d_N$ h9		h	$D_1$	$L_1$	$r_1$	Radial Clearance $S_{max}$			
M2	M2S	W2	H	Standard Range	Extended Range	Groove Depth	Groove Diameter H9	Groove Width +0.2	Radius Max	2 MPa	10 MPa	20 MPa	40 MPa
RVA0	RVC0	RVJ0	RVE0	3.0 - 9.9	3.0 - 40.0	1.45	$d_N + 2.9$	2.4	0.25	0.20	0.10	0.08	0.05
RVA1	RVC1	RVJ1	RVE1	10.0 - 19.9	6.0 - 200.0	2.25	$d_N + 4.5$	3.6	0.38	0.25	0.15	0.10	0.07
RVA2	RVC2	RVJ2	RVE2	20.0 - 39.9	10.0 - 400.0	3.10	$d_N + 6.2$	4.8	0.38	0.35	0.20	0.15	0.08
RVA3	RVC3	RVJ3	RVE3	40.0 - 119.9	20.0 - 700.0	4.70	$d_N + 9.4$	7.1	0.38	0.50	0.25	0.20	0.10
RVA4	RVC4	RVJ4	RVE4	120.0 - 999.9	35.0 - 1600.0	6.10	$d_N + 12.2$	9.5	0.51	0.60	0.30	0.25	0.12
RVA5	RVC5	RVJ5	RVE5	1000.0 - 2500.0	80.0 - 2500.0	9.50	$d_N + 19.0$	15.0	0.51	0.90	0.50	0.40	0.20

**Table 13: Size Series – Metric**

$d_N$	$D_1$	TSS Part No.	$d_N$	$D_1$	TSS Part No.	$d_N$	$D_1$	TSS Part No.
3.0	5.9	RV_0_0030	<b>32.0</b>	<b>38.2</b>	RV_2_0320	<b>80.0</b>	<b>89.4</b>	RV_3_0800
4.0	6.9	RV_0_0040	35.0	41.2	RV_2_0350	85.0	94.4	RV_3_0850
5.0	7.9	RV_0_0050	<b>36.0</b>	<b>42.2</b>	RV_2_0360	<b>90.0</b>	<b>99.4</b>	RV_3_0900
6.0	8.9	RV_0_0060	<b>40.0</b>	<b>49.4</b>	RV_3_0400	95.0	104.4	RV_3_0950
8.0	10.9	RV_0_0080	42.0	51.4	RV_3_0420	<b>100.0</b>	<b>109.4</b>	RV_3_1000
10.0	14.5	RV_1_0100	<b>45.0</b>	<b>54.4</b>	RV_3_0450	105.0	114.4	RV_3_1050
12.0	16.5	RV_1_0120	48.0	57.4	RV_3_0480	<b>110.0</b>	<b>119.4</b>	RV_3_1100
14.0	18.5	RV_1_0140	<b>50.0</b>	<b>59.4</b>	RV_3_0500	115.0	124.4	RV_3_1150
15.0	19.5	RV_1_0150	52.0	61.4	RV_3_0520	120.0	132.2	RV_4_1200
16.0	20.5	RV_1_0160	55.0	64.4	RV_3_0550	<b>125.0</b>	<b>137.2</b>	RV_4_1250
18.0	22.5	RV_1_0180	<b>56.0</b>	<b>65.4</b>	RV_3_0560	130.0	142.2	RV_4_1300
20.0	26.2	RV_2_0200	60.0	69.4	RV_3_0600	135.0	147.2	RV_4_1350
22.0	28.2	RV_2_0220	<b>63.0</b>	<b>72.4</b>	RV_3_0630	<b>140.0</b>	<b>152.2</b>	RV_4_1400
25.0	31.2	RV_2_0250	65.0	74.4	RV_3_0650			
28.0	34.2	RV_2_0280	<b>70.0</b>	<b>79.4</b>	RV_3_0700			
30.0	36.2	RV_2_0300	75.0	84.4	RV_3_0750			

Rod diameters in **bold** type correspond to the recommendations of ISO 3320. For additional size and part number details please contact your local Trelleborg Sealing Solutions Marketing company.



**Table 14: Part Number System for Rod Variseal® – Metric**

Article Code	Cross-Section	Size	Class	Seal Material	Spring Material	Spring Load
<b>RVA</b> Variseal M2	<b>0</b> 1.45	<b>With Notches</b>	- Industrial	<b>T01</b>	<b>S</b> Stainless Steel	<b>Standard load for each design</b>
<b>RVC</b> Variseal M2S	<b>1</b> 2.25	<b>Oxxxx</b> Rod dia <1000 (dia x 10.0)	<b>A</b> Aerospace	<b>MF1</b>	<b>H</b> Hastelloy	
<b>RVE</b> Variseal H	<b>2</b> 3.10			<b>MF4</b>	<b>E</b> Elgiloy	
<b>RVJ</b> Variseal W2	<b>3</b> 4.70	<b>Xxxxx</b> Rod dia. >= 1000 (dia x 1.0)		<b>MF6</b>		
	<b>4</b> 6.10			<b>T05</b>		
	<b>5</b> 9.50	<b>No Notches</b>		<b>T07</b> See page 7 for material description		<b>RVA &amp; RVC</b>
		<b>Nxxxx</b> Rod dia <1000 (dia x 10.0)		<b>T12</b>		<b>M</b> Medium
		<b>Vxxxx</b> Rod dia. >= 1000 (dia x 1.0)		<b>T24</b>		<b>R</b> High Clean
				<b>T40</b>		<b>RVE</b>
				<b>M79</b>		<b>H</b> Heavy
				<b>Z48</b>		<b>RVJ</b>
				<b>Z80</b>		<b>M</b> Medium

**ORDERING EXAMPLE 1**

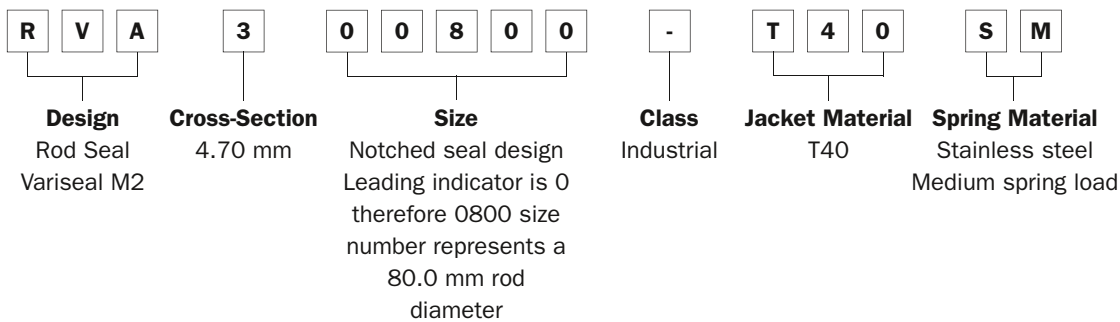

**ORDERING EXAMPLE 2**

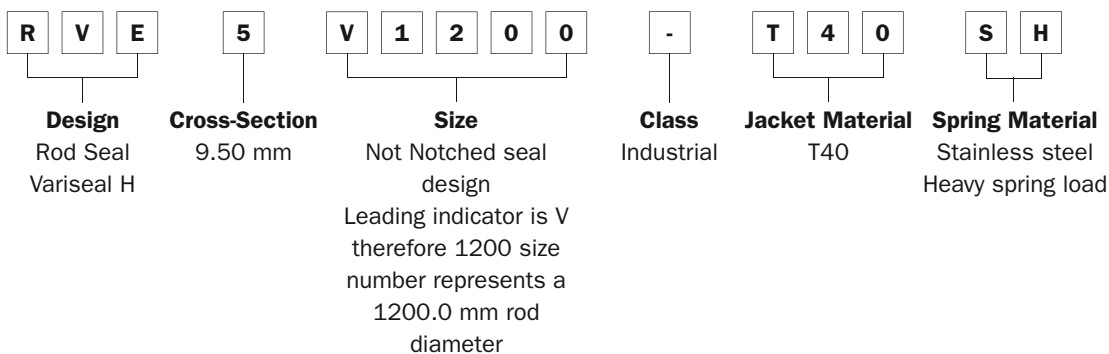



## ■ Installation Recommendations for Rod Seals – Types M2, M2S, W2 and H – Inch

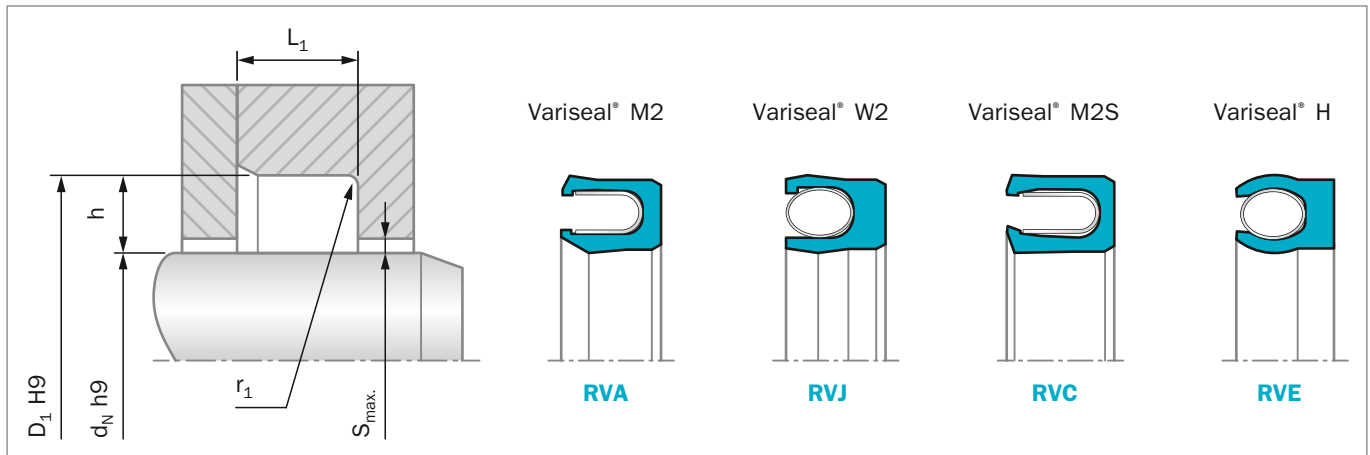

Figure 19: Installation Drawing

**Table 15: Installation Dimensions – Inch**

Series Number for Types				h Groove Depth	L <sub>1</sub> Groove Width	r <sub>1</sub> Radius	Radial Clearance S <sub>max</sub>			
M2	M2S	W2	H				290 psi	1,450 psi	2,900 psi	5,800 psi
					+0.010	Max				
RVAA	RVCA	RVJA	RVEA	0.062	0.094	0.010	0.008	0.004	0.003	0.002
RVAB	RVCB	RVJB	RVEB	0.093	0.141	0.015	0.010	0.006	0.004	0.003
RVAC	RVCC	RVJC	RVEC	0.125	0.188	0.015	0.014	0.008	0.006	0.003
RVAD	RVCD	RVJD	RVED	0.187	0.281	0.015	0.020	0.010	0.008	0.004
RVAE	RVCE	RVJE	RVEE	0.250	0.375	0.020	0.024	0.012	0.010	0.005
RVAG	RVCG	RVJG	RVEG	0.375	0.591	0.020	0.030	0.015	0.012	0.006

**Table 16: Size Series – Inch**

d <sub>N</sub>	D <sub>1</sub>	TSS Part No.	d <sub>N</sub>	D <sub>1</sub>	TSS Part No.	d <sub>N</sub>	D <sub>1</sub>	TSS Part No.
<b>0.125</b>	<b>0.250</b>	<b>RV_A_B006</b>	<b>0.437</b>	<b>0.625</b>	<b>RV_B_B111</b>	0.750	1.000	RV_C_B210
<b>0.156</b>	<b>0.281</b>	<b>RV_A_B007</b>	0.437	0.687	RV_C_B205	0.812	0.937	RV_A_B019
<b>0.187</b>	<b>0.312</b>	<b>RV_A_B008</b>	0.500	0.625	RV_A_B014	<b>0.812</b>	<b>1.000</b>	<b>RV_B_B117</b>
0.187	0.375	RV_B_B106	<b>0.500</b>	<b>0.687</b>	<b>RV_B_B112</b>	0.812	1.062	RV_C_B211
<b>0.219</b>	<b>0.343</b>	<b>RV_A_B009</b>	0.500	0.750	RV_C_B206	0.875	1.000	RV_A_B020
0.219	0.406	RV_B_B107	0.562	0.687	RV_A_B015	<b>0.875</b>	<b>1.062</b>	<b>RV_B_B118</b>
0.250	0.375	RV_A_B010	<b>0.562</b>	<b>0.750</b>	<b>RV_B_B113</b>	0.875	1.125	RV_C_B212
<b>0.250</b>	<b>0.437</b>	<b>RV_B_B108</b>	0.562	0.812	RV_C_B207	0.875	1.250	RV_D_B316
0.250	0.500	RV_C_B202	0.625	0.750	RV_A_B016	0.937	1.062	RV_A_B021
0.312	0.437	RV_A_B011	<b>0.625</b>	<b>0.812</b>	<b>RV_B_B114</b>	<b>0.937</b>	<b>1.125</b>	<b>RV_B_B119</b>
<b>0.312</b>	<b>0.500</b>	<b>RV_B_B109</b>	0.625	0.875	RV_C_B208	0.937	1.187	RV_C_B213
0.312	0.562	RV_C_B203	0.687	0.812	RV_A_B017	0.937	1.312	RV_D_B317
0.375	0.500	RV_A_B012	<b>0.687</b>	<b>0.875</b>	<b>RV_B_B115</b>	1.000	1.125	RV_A_B022
<b>0.375</b>	<b>0.562</b>	<b>RV_B_B110</b>	0.687	0.937	RV_C_B209	1.000	1.187	RV_B_B120
0.375	0.625	RV_C_B204	0.750	0.875	RV_A_B018	<b>1.000</b>	<b>1.250</b>	<b>RV_C_B214</b>
0.437	0.562	RV_A_B013	<b>0.750</b>	<b>0.937</b>	<b>RV_B_B116</b>	1.000	1.375	RV_D_B318



d <sub>N</sub>	D <sub>1</sub>	TSS Part No.	d <sub>N</sub>	D <sub>1</sub>	TSS Part No.	d <sub>N</sub>	D <sub>1</sub>	TSS Part No.
1.062	1.187	RV_A_B023	1.875	2.062	RV_B_B134	2.750	3.250	RV_E_B411
1.062	1.250	RV_B_B121	<b>1.875</b>	<b>2.125</b>	<b>RV_C_B225</b>	2.812	3.000	RV_B_B149
<b>1.062</b>	<b>1.312</b>	<b>RV_C_B215</b>	1.875	2.250	RV_D_B328	2.875	3.000	RV_A_B040
1.062	1.437	RV_D_B319	1.875	2.375	RV_E_B404	2.875	3.062	RV_B_B150
1.125	1.250	RV_A_B024	1.937	2.125	RV_B_B135	<b>2.875</b>	<b>3.125</b>	<b>RV_C_B233</b>
1.125	1.312	RV_B_B122	2.000	2.125	RV_A_B033	2.875	3.250	RV_D_B336
<b>1.125</b>	<b>1.375</b>	<b>RV_C_B216</b>	2.000	2.187	RV_B_B136	2.875	3.375	RV_E_B412
1.125	1.500	RV_D_B320	<b>2.000</b>	<b>2.250</b>	<b>RV_C_B226</b>	3.000	3.125	RV_A_B041
1.187	1.312	RV_A_B025	2.000	2.375	RV_D_B329	3.000	3.188	RV_B_B151
1.187	1.375	RV_B_B123	2.000	2.500	RV_E_B405	<b>3.000</b>	<b>3.250</b>	<b>RV_C_B234</b>
<b>1.187</b>	<b>1.437</b>	<b>RV_C_B217</b>	2.062	2.250	RV_B_B137	3.000	3.375	RV_D_B337
1.187	1.562	RV_D_B321	2.125	2.250	RV_A_B034	3.000	3.500	RV_E_B413
1.250	1.375	RV_A_B026	2.125	2.312	RV_B_B138	<b>3.125</b>	<b>3.375</b>	<b>RV_C_B235</b>
1.250	1.437	RV_B_B124	<b>2.125</b>	<b>2.375</b>	<b>RV_C_B227</b>	3.125	3.500	RV_D_B338
<b>1.250</b>	<b>1.500</b>	<b>RV_C_B218</b>	2.125	2.500	RV_D_B330	3.125	3.625	RV_E_B414
1.250	1.625	RV_D_B322	2.125	2.625	RV_E_B406	3.250	3.375	RV_A_B042
1.312	1.437	RV_A_B027	2.187	2.375	RV_B_B139	3.250	3.437	RV_B_B152
1.312	1.500	RV_B_B125	2.250	2.375	RV_A_B035	<b>3.250</b>	<b>3.500</b>	<b>RV_C_B236</b>
<b>1.312</b>	<b>1.562</b>	<b>RV_C_B219</b>	2.250	2.437	RV_B_B140	3.250	3.625	RV_D_B339
1.312	1.687	RV_D_B323	<b>2.250</b>	<b>2.500</b>	<b>RV_C_B228</b>	3.250	3.750	RV_E_B415
1.375	1.500	RV_A_B028	2.250	2.625	RV_D_B331	3.375	3.625	RV_C_B237
1.375	1.562	RV_B_B126	2.250	2.750	RV_E_B407	<b>3.375</b>	<b>3.750</b>	<b>RV_D_B340</b>
<b>1.375</b>	<b>1.625</b>	<b>RV_C_B220</b>	2.312	2.500	RV_B_B141	3.375	3.875	RV_E_B416
1.375	1.750	RV_D_B324	2.375	2.500	RV_A_B036	3.500	3.625	RV_A_B043
1.437	1.625	RV_B_B127	2.375	2.562	RV_B_B142	3.500	3.688	RV_B_B153
<b>1.437</b>	<b>1.687</b>	<b>RV_C_B221</b>	<b>2.375</b>	<b>2.625</b>	<b>RV_C_B229</b>	3.500	3.750	RV_C_B238
1.500	1.625	RV_A_B029	2.375	2.750	RV_D_B332	<b>3.500</b>	<b>3.875</b>	<b>RV_D_B341</b>
1.500	1.687	RV_B_B128	2.375	2.875	RV_E_B408	3.500	4.000	RV_E_B417
<b>1.500</b>	<b>1.750</b>	<b>RV_C_B222</b>	2.437	2.625	RV_B_B143	3.625	3.875	RV_C_B239
1.500	1.875	RV_D_B325	2.500	2.625	RV_A_B037	<b>3.625</b>	<b>4.000</b>	<b>RV_D_B342</b>
1.500	2.000	RV_E_B401	2.500	2.687	RV_B_B144	3.625	4.125	RV_E_B418
1.562	1.750	RV_B_B129	<b>2.500</b>	<b>2.750</b>	<b>RV_C_B230</b>	3.750	3.875	RV_A_B044
1.625	1.750	RV_A_B030	2.500	2.875	RV_D_B333	3.750	3.937	RV_B_B154
1.625	1.812	RV_B_B130	2.500	3.000	RV_E_B409	3.750	4.000	RV_C_B240
<b>1.625</b>	<b>1.875</b>	<b>RV_C_B223</b>	2.562	2.750	RV_B_B145	<b>3.750</b>	<b>4.125</b>	<b>RV_D_B343</b>
1.625	2.000	RV_D_B326	2.625	2.750	RV_A_B038	3.750	4.250	RV_E_B419
1.625	2.125	RV_E_B402	2.625	2.812	RV_B_B146	3.875	4.125	RV_C_B241
1.687	1.875	RV_B_B131	<b>2.625</b>	<b>2.875</b>	<b>RV_C_B231</b>	<b>3.875</b>	<b>4.250</b>	<b>RV_D_B344</b>
1.750	1.875	RV_A_B031	2.625	3.000	RV_D_B334	3.875	4.375	RV_E_B420
1.750	1.937	RV_B_B132	2.625	3.125	RV_E_B410	4.000	4.125	RV_A_B045
<b>1.750</b>	<b>2.000</b>	<b>RV_C_B224</b>	2.687	2.875	RV_B_B147	4.000	4.187	RV_B_B155
1.750	2.125	RV_D_B327	2.750	2.875	RV_A_B039	4.000	4.250	RV_C_B242
1.750	2.250	RV_E_B403	2.750	2.937	RV_B_B148	<b>4.000</b>	<b>4.375</b>	<b>RV_D_B345</b>
1.812	2.000	RV_B_B133	<b>2.750</b>	<b>3.000</b>	<b>RV_C_B232</b>	4.000	4.500	RV_E_B421
1.875	2.000	RV_A_B032	2.750	3.125	RV_D_B335	4.125	4.375	RV_C_B243



d <sub>N</sub>	D <sub>1</sub>	TSS Part No.	d <sub>N</sub>	D <sub>1</sub>	TSS Part No.	d <sub>N</sub>	D <sub>1</sub>	TSS Part No.
<b>4.125</b>	<b>4.500</b>	<b>RV_D_B346</b>	<b>5.375</b>	<b>5.875</b>	<b>RV_E_B432</b>	7.750	8.125	RV_D_B368
4.125	4.625	RV_E_B422	5.500	5.687	RV_B_B161	<b>7.750</b>	<b>8.250</b>	<b>RV_E_B444</b>
4.250	4.437	RV_B_B156	5.500	5.750	RV_C_B254	8.000	8.250	RV_C_B266
4.250	4.500	RV_C_B244	5.500	5.875	RV_D_B357	8.000	8.375	RV_D_B369
<b>4.250</b>	<b>4.625</b>	<b>RV_D_B347</b>	<b>5.500</b>	<b>6.000</b>	<b>RV_E_B433</b>	<b>8.000</b>	<b>8.500</b>	<b>RV_E_B445</b>
4.250	4.750	RV_E_B423	5.625	5.875	RV_C_B255	8.250	8.500	RV_C_B267
4.375	4.625	RV_C_B245	5.625	6.000	RV_D_B358	8.250	8.625	RV_D_B370
<b>4.375</b>	<b>4.750</b>	<b>RV_D_B348</b>	<b>5.625</b>	<b>6.125</b>	<b>RV_E_B434</b>	8.500	8.750	RV_C_B268
4.375	4.875	RV_E_B424	5.750	6.000	RV_C_B256	8.500	8.875	RV_D_B371
4.500	4.687	RV_B_B157	5.750	6.125	RV_D_B359	<b>8.500</b>	<b>9.000</b>	<b>RV_E_B446</b>
4.500	4.750	RV_C_B246	<b>5.750</b>	<b>6.250</b>	<b>RV_E_B435</b>	8.750	9.000	RV_C_B269
<b>4.500</b>	<b>4.875</b>	<b>RV_D_B349</b>	5.875	6.125	RV_C_B257	8.750	9.125	RV_D_B372
4.500	5.000	RV_E_B425	5.875	6.250	RV_D_B360	9.000	9.250	RV_C_B270
4.625	4.875	RV_C_B247	<b>5.875</b>	<b>6.375</b>	<b>RV_E_B436</b>	9.000	9.375	RV_D_B373
<b>4.625</b>	<b>5.000</b>	<b>RV_D_B350</b>	6.000	6.250	RV_C_B258	<b>9.000</b>	<b>9.500</b>	<b>RV_E_B447</b>
4.625	5.125	RV_E_B426	6.000	6.375	RV_D_B361	9.250	9.625	RV_D_B374
4.750	4.937	RV_B_B158	<b>6.000</b>	<b>6.500</b>	<b>RV_E_B437</b>	9.500	9.875	RV_D_B375
4.750	5.000	RV_C_B248	6.250	6.500	RV_C_B259	<b>9.500</b>	<b>10.000</b>	<b>RV_E_B448</b>
<b>4.750</b>	<b>5.125</b>	<b>RV_D_B351</b>	6.250	6.625	RV_D_B362	9.750	10.125	RV_D_B376
4.750	5.250	RV_E_B427	<b>6.250</b>	<b>6.750</b>	<b>RV_E_B438</b>	10.000	10.375	RV_D_B377
4.875	5.125	RV_C_B249	6.500	6.750	RV_C_B260	<b>10.000</b>	<b>10.500</b>	<b>RV_E_B449</b>
<b>4.875</b>	<b>5.250</b>	<b>RV_D_B352</b>	6.500	6.875	RV_D_B363	10.500	10.875	RV_D_B378
4.875	5.375	RV_E_B428	<b>6.500</b>	<b>7.000</b>	<b>RV_E_B439</b>	<b>10.500</b>	<b>11.000</b>	<b>RV_E_B450</b>
5.000	5.187	RV_B_B159	6.750	7.000	RV_C_B261	<b>11.000</b>	<b>11.500</b>	<b>RV_E_B451</b>
5.000	5.250	RV_C_B250	6.750	7.125	RV_D_B364	<b>11.500</b>	<b>12.000</b>	<b>RV_E_B452</b>
<b>5.000</b>	<b>5.375</b>	<b>RV_D_B353</b>	<b>6.750</b>	<b>7.250</b>	<b>RV_E_B440</b>	<b>12.000</b>	<b>12.500</b>	<b>RV_E_B453</b>
5.000	5.500	RV_E_B429	7.000	7.250	RV_C_B262	<b>12.500</b>	<b>13.000</b>	<b>RV_E_B454</b>
5.125	5.375	RV_C_B251	7.000	7.375	RV_D_B365	<b>13.000</b>	<b>13.500</b>	<b>RV_E_B455</b>
5.125	5.500	RV_D_B354	<b>7.000</b>	<b>7.500</b>	<b>RV_E_B441</b>	<b>13.500</b>	<b>14.000</b>	<b>RV_E_B456</b>
<b>5.125</b>	<b>5.625</b>	<b>RV_E_B430</b>	7.250	7.500	RV_C_B263	<b>14.000</b>	<b>14.500</b>	<b>RV_E_B457</b>
5.250	5.437	RV_B_B160	7.250	7.625	RV_D_B366	<b>14.500</b>	<b>15.000</b>	<b>RV_E_B458</b>
5.250	5.500	RV_C_B252	<b>7.250</b>	<b>7.750</b>	<b>RV_E_B442</b>	<b>15.000</b>	<b>15.500</b>	<b>RV_E_B459</b>
5.250	5.625	RV_D_B355	7.500	7.750	RV_C_B264	<b>15.500</b>	<b>16.000</b>	<b>RV_E_B460</b>
<b>5.250</b>	<b>5.750</b>	<b>RV_E_B431</b>	7.500	7.875	RV_D_B367			
5.375	5.625	RV_C_B253	<b>7.500</b>	<b>8.000</b>	<b>RV_E_B443</b>			
5.375	5.750	RV_D_B356	7.750	8.000	RV_C_B265			

Figures in **bold** are preferred sizes.  
 For additional size and part number details please  
 contact your local Trelleborg Sealing Solutions  
 Marketing company.



**Table 17: Part Number System for Rod Variseal® – Inch**

Article Code	Cross-Section	Size	Class	Seal Material	Spring Material	Spring Load
<b>RVA</b> Variseal M2	<b>Inch</b>	<b>With Notches</b>	- Industrial	<b>T01</b>	<b>S</b> Stainless Steel	<b>Standard load for each design</b>
<b>RVC</b> Variseal M2S	<b>A</b> 0.062	<b>OBxxx</b> Inch Dash #	<b>A</b> Aerospace	<b>MF1</b>		
<b>RVE</b> Variseal H	<b>B</b> 0.093	<b>Sxxxx</b> Rod dia <10.0 Inch (dia x 1000.0)		<b>MF4</b>	<b>H</b> Hastelloy	
<b>RVJ</b> Variseal W2	<b>C</b> 0.125	<b>Lxxxx</b> Rod dia. >= 10.0 (dia x 100.0)		<b>MF6</b>	<b>E</b> Elgiloy	
	<b>D</b> 0.187			<b>T05</b>		<b>RVA &amp; RVC</b>
	<b>E</b> 0.250			<b>T07</b> See page 7 for material description		<b>M</b> Medium
	<b>G</b> 0.375			<b>T12</b>		<b>R</b> High Clean
		<b>No Notches</b>		<b>T24</b>		
		<b>NBxxx</b> Inch Dash #		<b>T40</b>		<b>RVE</b>
		<b>Rxxxx</b> Rod dia <10.0 Inch (dia x 1000.0)		<b>M79</b>		<b>H</b> Heavy
		<b>Kxxxx</b> Rod dia. >= 10.0 (dia x 100.0)		<b>Z48</b>		
				<b>Z80</b>		<b>RVJ</b>
						<b>M</b> Medium

**ORDERING EXAMPLE 1**

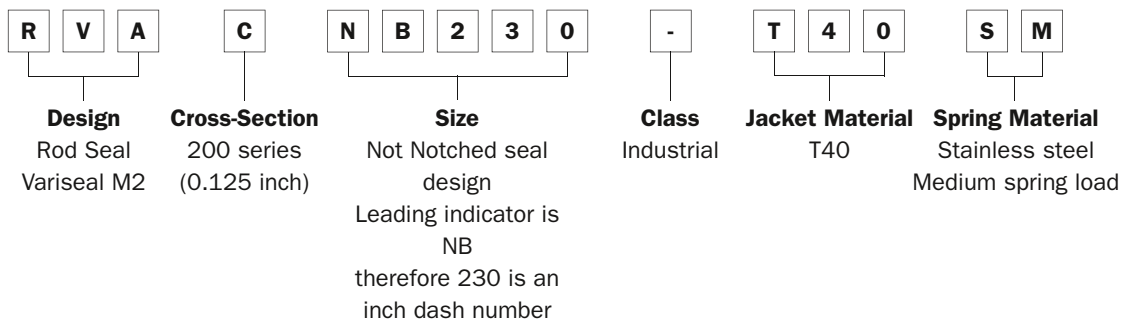

**ORDERING EXAMPLE 2**

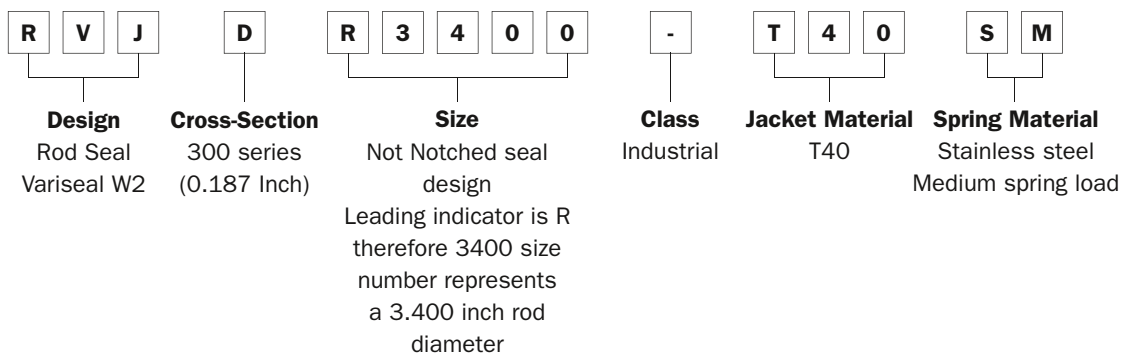



## ■ Installation Recommendations for AS4716 Rod Seals – Types M2, M2S, W2 and H – Inch

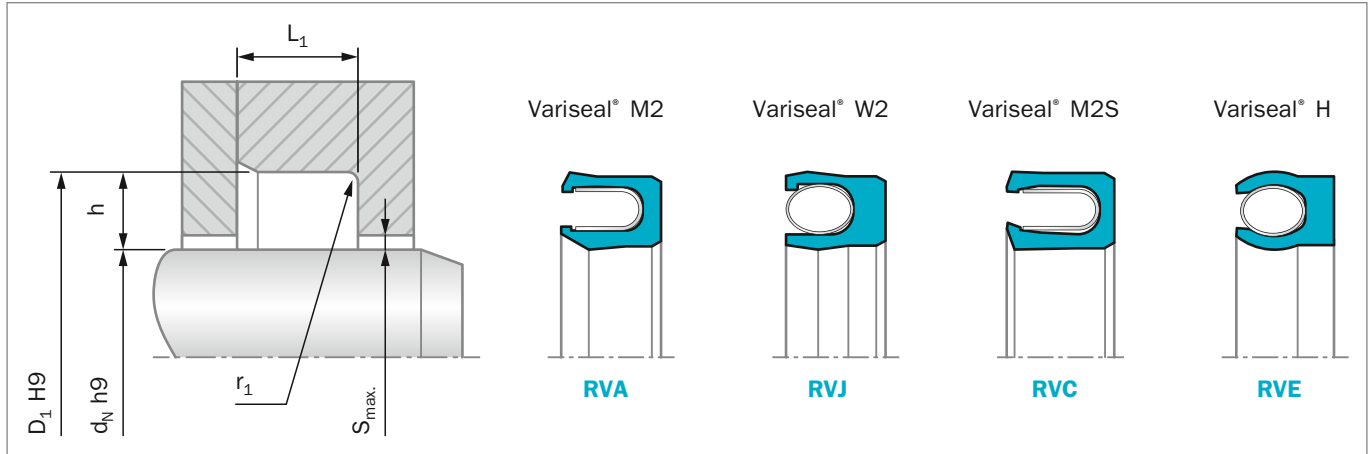

Figure 20: Installation Drawing

**Table 18: Installation Dimensions AS4716 – Inch**

Series Number for Types				h Groove Depth	L <sub>1</sub> Groove Width +0.010	r <sub>1</sub> Radius Max	Radial Clearance S <sub>max</sub>			
M2	M2S	W2	H				290 psi	1,450 psi	2,900 psi	5,800 psi
RVA0	RVC0	RVJ0	RVE0	0.056	0.094	0.010	0.008	0.004	0.003	0.002
RVA1	RVC1	RVJ1	RVE1	0.087	0.141	0.015	0.010	0.006	0.004	0.003
RVA2	RVC2	RVJ2	RVE2	0.122	0.188	0.015	0.014	0.008	0.006	0.003
RVA3	RVC3	RVJ3	RVE3	0.185	0.281	0.015	0.020	0.010	0.008	0.004
RVA4	RVC4	RVJ4	RVE4	0.239	0.375	0.020	0.024	0.012	0.010	0.005

AS4716 states hardware tolerances to h8/H8. However Variseals are suitable with h9/H9 tolerances. h9/H9 tolerance dimensions can be found using the ISO Fits & Tolerances App, see page 88.

**Table 19: Standard Dash Sizes AS4716 – Inch**

d <sub>N</sub>	D <sub>1</sub>	TSS Part No.	d <sub>N</sub>	D <sub>1</sub>	TSS Part No.	d <sub>N</sub>	D <sub>1</sub>	TSS Part No.
<b>0.123</b>	<b>0.232</b>	<b>RV_0_M006</b>	0.498	0.608	RV_0_M014	0.873	0.983	RV_0_M020
<b>0.154</b>	<b>0.264</b>	<b>RV_0_M007</b>	<b>0.498</b>	<b>0.672</b>	<b>RV_1_M112</b>	<b>0.873</b>	<b>1.048</b>	<b>RV_1_M118</b>
<b>0.185</b>	<b>0.294</b>	<b>RV_0_M008</b>	0.560	0.670	RV_0_M015	0.873	1.115	RV_2_M212
0.185	0.359	RV_1_M106	<b>0.560</b>	<b>0.734</b>	<b>RV_1_M113</b>	0.935	1.045	RV_0_M021
<b>0.217</b>	<b>0.327</b>	<b>RV_0_M009</b>	0.623	0.733	RV_0_M016	0.935	<b>1.110</b>	<b>RV_1_M119</b>
0.217	0.392	RV_1_M107	<b>0.623</b>	<b>0.797</b>	<b>RV_1_M114</b>	0.935	1.177	RV_2_M213
0.248	0.359	RV_0_M010	0.685	0.795	RV_0_M017	0.998	1.108	RV_0_M022
<b>0.248</b>	<b>0.423</b>	<b>RV_1_M108</b>	<b>0.685</b>	<b>0.859</b>	<b>RV_1_M115</b>	0.998	1.173	RV_1_M120
0.310	0.421	RV_0_M011	0.748	0.858	RV_0_M018	<b>0.998</b>	<b>1.240</b>	<b>RV_2_M214</b>
0.310	<b>0.486</b>	<b>RV_1_M109</b>	<b>0.748</b>	<b>0.923</b>	<b>RV_1_M116</b>	1.060	1.170	RV_0_M023
0.373	0.484	RV_0_M012	0.748	0.989	RV_2_M210	1.060	1.235	RV_1_M121
<b>0.373</b>	<b>0.546</b>	<b>RV_1_M110</b>	<b>0.810</b>	0.920	RV_0_M019	<b>1.060</b>	<b>1.302</b>	<b>RV_2_M215</b>
0.435	0.545	RV_0_M013	0.810	<b>0.985</b>	<b>RV_1_M117</b>	1.123	1.233	RV_0_M024
<b>0.435</b>	<b>0.609</b>	<b>RV_1_M111</b>	0.810	1.051	RV_2_M211	1.123	1.298	RV_1_M122





d <sub>N</sub>	D <sub>1</sub>	TSS Part No.	d <sub>N</sub>	D <sub>1</sub>	TSS Part No.	d <sub>N</sub>	D <sub>1</sub>	TSS Part No.
<b>1.123</b>	<b>1.365</b>	<b>RV_2_M216</b>	<b>2.373</b>	<b>2.615</b>	<b>RV_2_M229</b>	<b>4.622</b>	<b>5.099</b>	<b>RV_4_M426</b>
1.185	1.295	RV_0_M025	2.373	2.745	RV_3_M332	<b>4.747</b>	<b>5.224</b>	<b>RV_4_M427</b>
1.185	1.360	RV_1_M123	2.436	2.610	RV_1_M143	<b>4.872</b>	<b>5.349</b>	<b>RV_4_M428</b>
<b>1.185</b>	<b>1.427</b>	<b>RV_2_M217</b>	2.498	2.672	RV_1_M144	<b>4.997</b>	<b>5.474</b>	<b>RV_4_M429</b>
1.248	1.358	RV_0_M026	<b>2.498</b>	<b>2.740</b>	<b>RV_2_M230</b>	<b>5.122</b>	<b>5.599</b>	<b>RV_4_M430</b>
1.248	1.423	RV_1_M124	2.498	2.870	RV_3_M333	<b>5.247</b>	<b>5.724</b>	<b>RV_4_M431</b>
<b>1.248</b>	<b>1.490</b>	<b>RV_2_M218</b>	2.561	2.735	RV_1_M145	<b>5.372</b>	<b>5.849</b>	<b>RV_4_M432</b>
1.310	1.420	RV_0_M027	2.623	2.797	RV_1_M146	<b>5.497</b>	<b>5.974</b>	<b>RV_4_M433</b>
1.310	1.485	RV_1_M125	<b>2.623</b>	<b>2.865</b>	<b>RV_2_M231</b>	<b>5.622</b>	<b>6.099</b>	<b>RV_4_M434</b>
<b>1.310</b>	<b>1.552</b>	<b>RV_2_M219</b>	2.623	2.995	RV_3_M334	<b>5.747</b>	<b>6.224</b>	<b>RV_4_M435</b>
1.373	1.483	RV_0_M028	2.685	2.860	RV_1_M147	<b>5.872</b>	<b>6.349</b>	<b>RV_4_M436</b>
1.373	1.548	RV_1_M126	2.748	2.922	RV_1_M148	<b>5.997</b>	<b>6.474</b>	<b>RV_4_M437</b>
<b>1.373</b>	<b>1.615</b>	<b>RV_2_M220</b>	<b>2.748</b>	<b>2.990</b>	<b>RV_2_M232</b>	<b>6.247</b>	<b>6.724</b>	<b>RV_4_M438</b>
1.435	1.610	RV_1_M127	2.748	3.120	RV_3_M335	<b>6.497</b>	<b>6.974</b>	<b>RV_4_M439</b>
1.435	1.677	RV_2_M221	2.811	2.985	RV_1_M149	<b>6.747</b>	<b>7.224</b>	<b>RV_4_M440</b>
1.498	1.673	RV_1_M128	<b>2.873</b>	<b>3.115</b>	<b>RV_2_M233</b>	<b>6.997</b>	<b>7.474</b>	<b>RV_4_M441</b>
<b>1.498</b>	<b>1.740</b>	<b>RV_2_M222</b>	2.873	3.245	RV_3_M336	<b>7.247</b>	<b>7.724</b>	<b>RV_4_M442</b>
1.498	1.870	RV_3_M325	<b>2.997</b>	<b>3.239</b>	<b>RV_2_M234</b>	<b>7.497</b>	<b>7.974</b>	<b>RV_4_M443</b>
1.560	1.735	RV_1_M129	2.997	3.369	RV_3_M337	<b>7.747</b>	<b>8.224</b>	<b>RV_4_M444</b>
1.623	1.798	RV_1_M130	<b>3.122</b>	<b>3.364</b>	<b>RV_2_M235</b>	<b>7.997</b>	<b>8.474</b>	<b>RV_4_M445</b>
<b>1.623</b>	<b>1.865</b>	<b>RV_2_M223</b>	3.122	3.494	RV_3_M338	<b>8.497</b>	<b>8.974</b>	<b>RV_4_M446</b>
1.623	1.995	RV_3_M326	<b>3.247</b>	<b>3.489</b>	<b>RV_2_M236</b>	<b>8.997</b>	<b>9.474</b>	<b>RV_4_M447</b>
1.685	1.860	RV_1_M131	3.247	3.619	RV_3_M339	<b>9.497</b>	<b>9.974</b>	<b>RV_4_M448</b>
1.748	1.923	RV_1_M132	3.372	3.614	RV_2_M237	<b>9.997</b>	<b>10.474</b>	<b>RV_4_M449</b>
<b>1.748</b>	<b>1.990</b>	<b>RV_2_M224</b>	<b>3.372</b>	<b>3.744</b>	<b>RV_3_M340</b>	<b>10.497</b>	<b>10.974</b>	<b>RV_4_M450</b>
1.748	2.120	RV_3_M327	3.497	3.739	RV_2_M238	<b>10.997</b>	<b>11.474</b>	<b>RV_4_M451</b>
1.810	1.984	RV_1_M133	<b>3.497</b>	<b>3.869</b>	<b>RV_3_M341</b>	<b>11.497</b>	<b>11.974</b>	<b>RV_4_M452</b>
1.873	2.047	RV_1_M134	3.622	3.864	RV_2_M239	<b>11.997</b>	<b>12.474</b>	<b>RV_4_M453</b>
<b>1.873</b>	<b>2.115</b>	<b>RV_2_M225</b>	<b>3.622</b>	<b>3.994</b>	<b>RV_3_M342</b>	<b>12.497</b>	<b>12.974</b>	<b>RV_4_M454</b>
1.873	2.245	RV_3_M328	3.747	3.989	RV_2_M240	<b>12.997</b>	<b>13.474</b>	<b>RV_4_M455</b>
1.936	2.110	RV_1_M135	<b>3.747</b>	<b>4.119</b>	<b>RV_3_M343</b>	<b>13.497</b>	<b>13.974</b>	<b>RV_4_M456</b>
1.998	2.172	RV_1_M136	3.872	4.114	RV_2_M241	<b>13.997</b>	<b>14.474</b>	<b>RV_4_M457</b>
<b>1.998</b>	<b>2.240</b>	<b>RV_2_M226</b>	<b>3.872</b>	<b>4.244</b>	<b>RV_3_M344</b>	<b>14.497</b>	<b>14.974</b>	<b>RV_4_M458</b>
1.998	2.370	RV_3_M329	3.997	4.239	RV_2_M242	<b>14.997</b>	<b>15.474</b>	<b>RV_4_M459</b>
2.061	2.235	RV_1_M137	<b>3.997</b>	<b>4.369</b>	<b>RV_3_M345</b>	<b>15.497</b>	<b>15.974</b>	<b>RV_4_M460</b>
2.123	2.297	RV_1_M138	4.122	4.364	RV_2_M243			
<b>2.123</b>	<b>2.365</b>	<b>RV_2_M227</b>	<b>4.122</b>	<b>4.494</b>	<b>RV_3_M346</b>			
2.123	2.495	RV_3_M330	4.247	4.489	RV_2_M244			
2.186	2.360	RV_1_M139	<b>4.247</b>	<b>4.619</b>	<b>RV_3_M347</b>			
2.248	2.422	RV_1_M140	4.372	4.614	RV_2_M245			
<b>2.248</b>	<b>2.490</b>	<b>RV_2_M228</b>	<b>4.372</b>	<b>4.744</b>	<b>RV_3_M348</b>			
2.248	2.620	RV_3_M331	4.497	4.739	RV_2_M246			
2.311	2.485	RV_1_M141	4.497	<b>4.869</b>	<b>RV_3_M349</b>			
2.373	2.547	RV_1_M142	4.497	4.974	RV_4_M425			

Figures in **bold** are preferred sizes.  
For additional size and part number details please contact your local Trelleborg Sealing Solutions Marketing company.



**Table 20: Part Number System for AS4716 Rod Variseal® – Inch**

Article Code	Cross-Section	Size	Class	Seal Material	Spring Material	Spring Load
<b>RVA</b> Variseal M2	<b>AS4716</b>	<b>With Notches</b>	- Industrial	<b>T01</b>	<b>S</b> Stainless Steel	<b>Standard load for each design</b>
<b>RVC</b> Variseal M2S	<b>0</b> 0.056	<b>OMxxx</b> AS4716 Dash #	<b>A</b> Aerospace	<b>MF1</b>	<b>H</b> Hastelloy	
<b>RVE</b> Variseal H	<b>1</b> 0.087	<b>Sxxxx</b> Rod dia <10.0 Inch (dia x 1000.0)		<b>MF4</b>	<b>E</b> Elgiloy	<b>RVA &amp; RVC</b> <b>M</b> Medium <b>R</b> High Clean
<b>RVJ</b> Variseal W2	<b>2</b> 0.122	<b>Lxxxx</b> Rod dia. >= 10.0 (dia x 100.0)		<b>MF6</b>		
	<b>3</b> 0.185			<b>T05</b>		<b>RVE</b> <b>H</b> Heavy
	<b>4</b> 0.239			<b>T07</b> See page 7 <b>T12</b> for material description <b>T24</b> description <b>T40</b>		
		<b>No Notches</b>		<b>M79</b>		<b>RVJ</b> <b>M</b> Medium
		<b>NMxxx</b> AS4716 Dash # <b>Rxxxx</b> Rod dia <10.0 Inch (dia x 1000.0) <b>Kxxxx</b> Rod dia. >= 10.0 (dia x 100.0)		<b>Z48</b> <b>Z80</b>		

**ORDERING EXAMPLE 1**

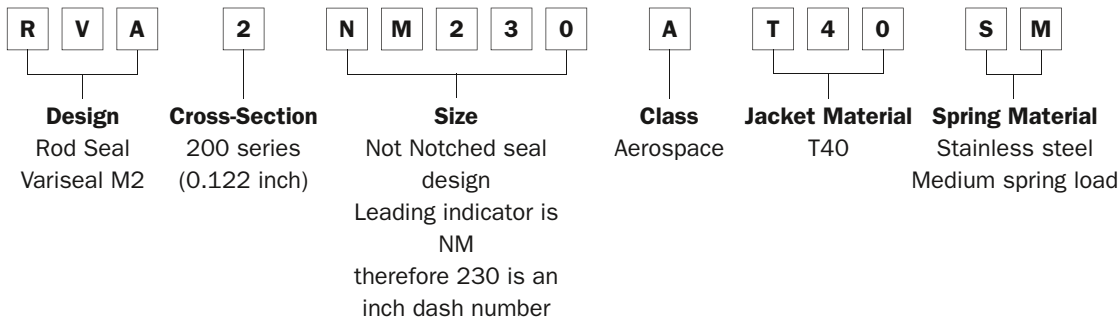

**ORDERING EXAMPLE 2**

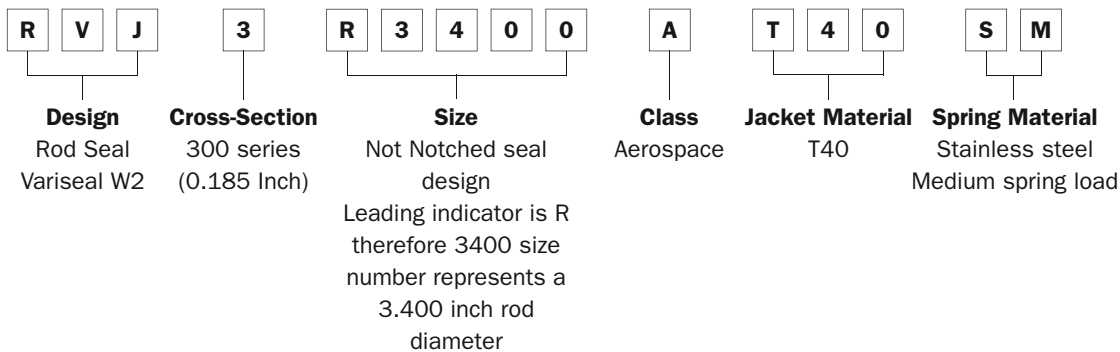

---

! This page is intentionally right blank.



## ■ Installation Recommendations for Piston Seals – Types M2, M2S, W2 and H – Metric

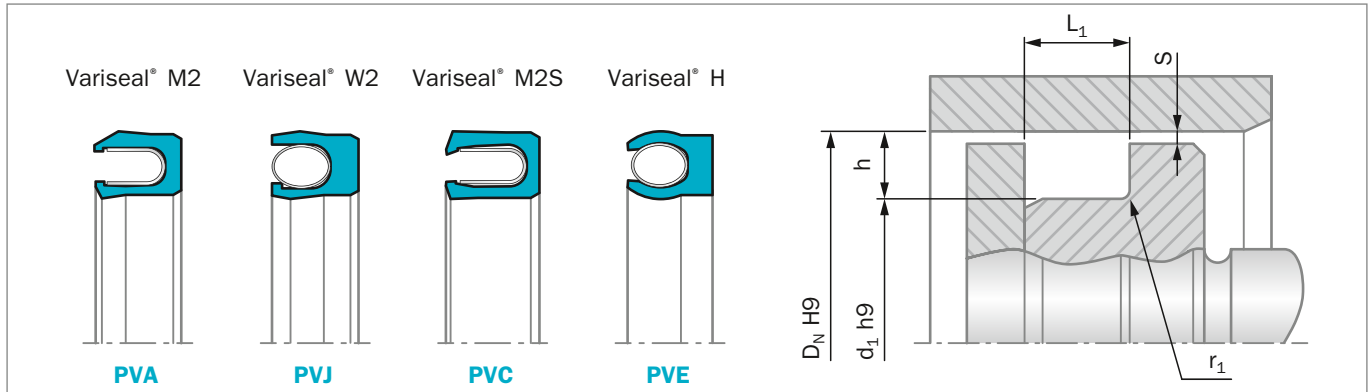

Figure 21: Installation Drawing

**Table 21: Installation Dimensions – Metric**

Series Number for Types				Bore Diameter $D_N$ H9		h	$d_1$	$L_1$	$r_1$	Radial Clearance $S_{max}$			
M2	M2S	W2	H	Standard Range	Extended Range	Groove Depth	Groove Diameter h9	Groove Width +0.2	Radius Max	2 MPa	10 MPa	20 MPa	40 MPa
PVA0	PVC0	PVJ0	PVE0	6.0 - 13.9	6.0 - 40.0	1.45	$D_N - 2.9$	2.4	0.25	0.20	0.10	0.08	0.05
PVA1	PVC1	PVJ1	PVE1	14.0 - 24.9	10.0 - 200.0	2.25	$D_N - 4.5$	3.6	0.38	0.25	0.15	0.10	0.07
PVA2	PVC2	PVJ2	PVE2	25.0 - 45.9	16.0 - 400.0	3.10	$D_N - 6.2$	4.8	0.38	0.35	0.20	0.15	0.08
PVA3	PVC3	PVJ3	PVE3	46.0 - 124.9	28.0 - 700.0	4.70	$D_N - 9.4$	7.1	0.38	0.50	0.25	0.20	0.10
PVA4	PVC4	PVJ4	PVE4	125.0 - 999.9	45.0 - 1600.0	6.10	$D_N - 12.2$	9.5	0.51	0.60	0.30	0.25	0.12
PVA5	PVC5	PVJ5	PVE5	1000.0 - 2500.0	100.0 - 2500.0	9.50	$D_N - 19.0$	15.0	0.51	0.90	0.50	0.40	0.20

$h_9/H_9$  tolerance dimensions can be found using the ISO Fits & Tolerances App, see page 88.

**Table 22: Size Series – Metric**

$D_N$	$d_1$	TSS Part No.	$D_N$	$d_1$	TSS Part No.	$D_N$	$d_1$	TSS Part No.
6.0	3.1	PV_0_0060	48.0	38.6	PV_3_0480	<b>125.0</b>	<b>112.8</b>	<b>PV_4_1250</b>
<b>8.0</b>	<b>5.1</b>	<b>PV_0_0080</b>	<b>50.0</b>	<b>40.6</b>	<b>PV_3_0500</b>	130.0	117.8	PV_4_1300
<b>10.0</b>	<b>7.1</b>	<b>PV_0_0100</b>	52.0	42.6	PV_3_0520	135.0	122.8	PV_4_1350
<b>12.0</b>	<b>9.1</b>	<b>PV_0_0120</b>	55.0	45.6	PV_3_0550	140.0	127.8	PV_4_1400
14.0	9.5	PV_1_0140	60.0	50.6	PV_3_0600	150.0	137.8	PV_4_1500
15.0	10.5	PV_1_0150	<b>63.0</b>	<b>53.6</b>	<b>PV_3_0630</b>	<b>160.0</b>	<b>147.8</b>	<b>PV_4_1600</b>
<b>16.0</b>	<b>11.5</b>	<b>PV_1_0160</b>	65.0	55.6	PV_3_0650	170.0	157.8	PV_4_1700
18.0	13.5	PV_1_0180	70.0	60.6	PV_3_0700	180.0	167.8	PV_4_1800
<b>20.0</b>	<b>15.5</b>	<b>PV_1_0200</b>	75.0	65.6	PV_3_0750	190.0	177.8	PV_4_1900
22.0	17.5	PV_1_0220	<b>80.0</b>	<b>70.6</b>	<b>PV_3_0800</b>	<b>200.0</b>	<b>187.8</b>	<b>PV_4_2000</b>
<b>25.0</b>	<b>18.8</b>	<b>PV_2_0250</b>	85.0	75.6	PV_3_0850	210.0	97.8	PV_4_2100
28.0	21.8	PV_2_0280	90.0	80.6	PV_3_0900	220.0	207.8	PV_4_2200
30.0	23.8	PV_2_0300	95.0	85.6	PV_3_0950	230.0	217.8	PV_4_2300
<b>32.0</b>	<b>25.8</b>	<b>PV_2_0320</b>	<b>100.0</b>	<b>90.6</b>	<b>PV_3_1000</b>	240.0	227.8	PV_4_2400
35.0	28.8	PV_2_0350	105.0	95.6	PV_3_1050	<b>250.0</b>	<b>237.8</b>	<b>PV_4_2500</b>
<b>40.0</b>	<b>33.8</b>	<b>PV_2_0400</b>	110.0	100.6	PV_3_1100			
42.0	35.8	PV_2_0420	115.0	105.6	PV_3_1150			
45.0	38.8	PV_2_0450	120.0	110.6	PV_3_1200			

Rod diameters in **bold** type correspond to the recommendations of ISO 3320.  
For additional size and part number details please contact your local Trelleborg Sealing Solutions Marketing company.



**Table 23: Part Number System for Piston Variseal® – Metric**

Article Code	Cross-Section	Size	Class	Seal Material	Spring Material	Spring Load
<b>PVA</b> Variseal M2	<b>0</b> 1.45	<b>With Notches</b>	- Industrial	<b>T01</b>	<b>S</b> Stainless Steel	<b>Standard load for each design</b>
<b>PVC</b> Variseal M2S	<b>1</b> 2.25	<b>Oxxxx</b> Bore dia <1000 (dia x 10.0)	<b>A</b> Aerospace	<b>MF1</b>	<b>H</b> Hastelloy	
<b>PVE</b> Variseal H	<b>2</b> 3.10	<b>Xxxxx</b> Bore dia. >= 1000 (dia x 1.0)		<b>MF4</b>	<b>E</b> Elgiloy	
<b>PVJ</b> Variseal W2	<b>3</b> 4.70			<b>MF6</b>		<b>PVA &amp; PVC</b>
	<b>4</b> 6.10			<b>T05</b>		<b>M</b> Medium
	<b>5</b> 9.50			<b>T07</b> See page 7		<b>R</b> High Clean
		<b>No Notches</b>		<b>T12</b> for material		<b>PVE</b>
		<b>Nxxxx</b> Bore dia <1000 (dia x 10.0)		<b>T24</b> description		<b>H</b> Heavy
		<b>Vxxxx</b> Bore dia. >= 1000 (dia x 1.0)		<b>T40</b>		<b>PVJ</b>
				<b>M79</b>		<b>M</b> Medium
				<b>Z48</b>		
				<b>Z80</b>		

**ORDERING EXAMPLE 1**

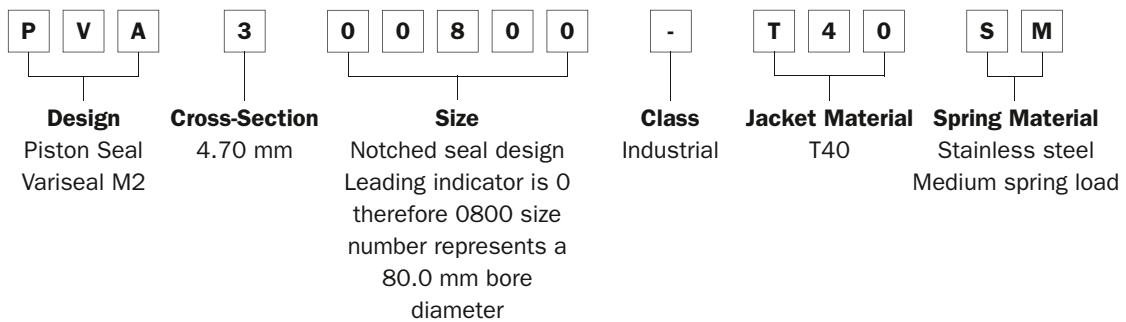

**ORDERING EXAMPLE 2**

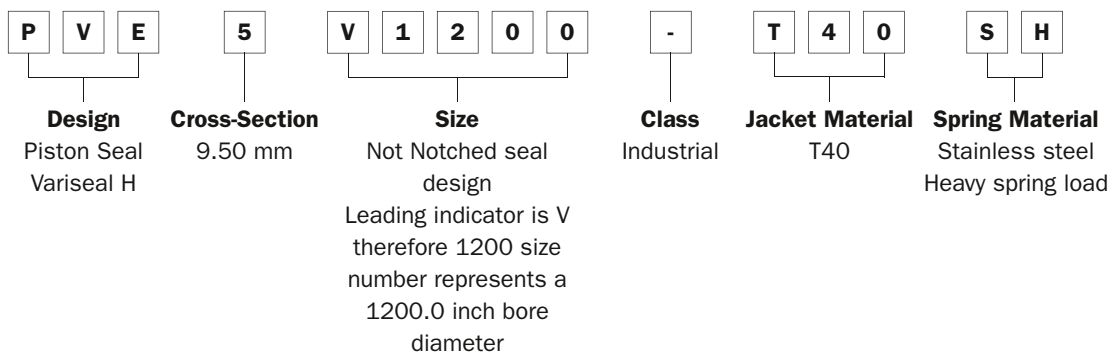



## ■ Installation Recommendation for Piston Seals – Types M2, M2S, W2 and H – Inch

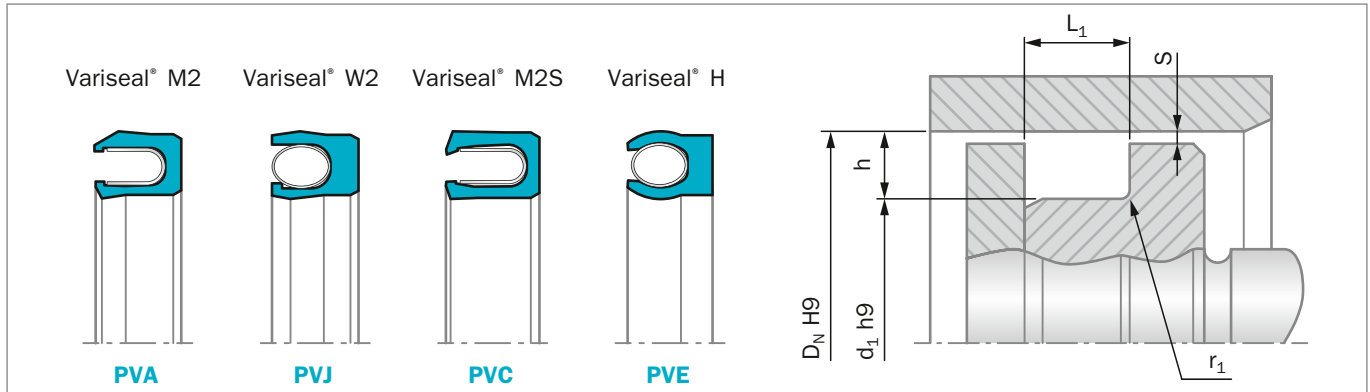

Figure 22: Installation Drawing

Table 24: Installation Dimensions – Inch

Series Number for Types				h Groove Depth	L <sub>1</sub> Groove Width +0.010	r <sub>1</sub> Radius Max	Radial Clearance S <sub>max</sub>			
M2	M2S	W2	H				290 psi	1,450 psi	2,900 psi	5,800 psi
PVAA	PVCA	PVJA	PVEA	0.062	0.094	0.010	0.008	0.004	0.003	0.002
PVAB	PVCB	PVJB	PVEB	0.093	0.141	0.015	0.010	0.006	0.004	0.003
PVAC	PVCC	PVJC	PVEC	0.125	0.188	0.015	0.014	0.008	0.006	0.003
PVAD	PVCD	PVJD	PVED	0.187	0.281	0.015	0.020	0.010	0.008	0.004
PVAE	PVCE	PVJE	PVEE	0.250	0.375	0.020	0.024	0.012	0.010	0.005
PVAG	PVAG	PVJG	PVEG	0.375	0.591	0.020	0.030	0.015	0.012	0.006

h9/H9 tolerance dimensions can be found using the ISO Fits & Tolerances App, see page 88.

Table 25: Standard Dash Sizes – Inch

D <sub>N</sub>	d <sub>1</sub>	TSS Part No.	D <sub>N</sub>	d <sub>1</sub>	TSS Part No.	D <sub>N</sub>	d <sub>1</sub>	TSS Part No.
0.250	0.125	PV_A_B006	0.625	0.437	PV_B_B111	0.937	0.687	PV_C_B209
0.281	0.156	PV_A_B007	0.625	0.375	PV_C_B204	1.000	0.875	PV_A_B020
0.312	0.187	PV_A_B008	0.687	0.562	PV_A_B015	<b>1.000</b>	<b>0.812</b>	<b>PV_B_B117</b>
0.343	0.218	PV_A_B009	<b>0.687</b>	<b>0.500</b>	<b>PV_B_B112</b>	1.000	0.750	PV_C_B210
0.375	0.250	PV_A_B010	0.687	0.437	PV_C_B205	1.062	0.937	PV_A_B021
0.375	0.187	PV_B_B106	0.750	0.625	PV_A_B016	<b>1.062</b>	<b>0.875</b>	<b>PV_B_B118</b>
0.406	0.219	PV_B_B107	<b>0.750</b>	<b>0.562</b>	<b>PV_B_B113</b>	1.062	0.812	PV_C_B211
0.437	0.312	PV_A_B011	0.750	0.500	PV_C_B206	1.125	1.000	PV_A_B022
0.437	0.250	PV_B_B108	0.812	0.687	PV_A_B017	<b>1.125</b>	<b>0.937</b>	<b>PV_B_B119</b>
0.500	0.375	PV_A_B012	<b>0.812</b>	<b>0.625</b>	<b>PV_B_B114</b>	1.125	0.875	PV_C_B212
0.500	0.312	PV_B_B109	0.812	0.562	PV_C_B207	1.187	1.062	PV_A_B023
0.500	0.250	PV_C_B202	0.875	0.750	PV_A_B018	<b>1.187</b>	<b>1.000</b>	<b>PV_B_B120</b>
0.562	0.437	PV_A_B013	<b>0.875</b>	<b>0.687</b>	<b>PV_B_B115</b>	1.187	0.937	PV_C_B213
0.562	0.375	PV_B_B110	0.875	0.625	PV_C_B208	1.250	1.125	PV_A_B024
0.562	0.312	PV_C_B203	0.937	0.812	PV_A_B019	1.250	1.062	PV_B_B121
0.625	0.500	PV_A_B014	<b>0.937</b>	<b>0.750</b>	<b>PV_B_B116</b>	<b>1.250</b>	<b>1.000</b>	<b>PV_C_B214</b>



D <sub>N</sub>	d <sub>1</sub>	TSS Part No.	D <sub>N</sub>	d <sub>1</sub>	TSS Part No.	D <sub>N</sub>	d <sub>1</sub>	TSS Part No.
1.250	0.875	PV_D_B316	<b>2.125</b>	<b>1.875</b>	<b>PV_C_B225</b>	3.062	2.875	PV_B_B150
1.312	1.187	PV_A_B025	2.125	1.750	PV_D_B327	3.125	3.000	PV_A_B041
1.312	1.125	PV_B_B122	2.125	1.625	PV_E_B402	<b>3.125</b>	<b>2.875</b>	<b>PV_C_B233</b>
<b>1.312</b>	<b>1.062</b>	<b>PV_C_B215</b>	2.187	2.000	PV_B_B136	3.125	2.750	PV_D_B335
1.312	0.937	PV_D_B317	2.250	2.125	PV_A_B034	3.125	2.625	PV_E_B410
1.375	1.250	PV_A_B026	2.250	2.062	PV_B_B137	3.188	3.000	PV_B_B151
1.375	1.187	PV_B_B123	<b>2.250</b>	<b>2.000</b>	<b>PV_C_B226</b>	<b>3.250</b>	<b>3.000</b>	<b>PV_C_B234</b>
<b>1.375</b>	<b>1.125</b>	<b>PV_C_B216</b>	2.250	1.875	PV_D_B328	3.250	2.875	PV_D_B336
1.375	1.000	PV_D_B318	2.250	1.750	PV_E_B403	3.250	2.750	PV_E_B411
1.437	1.312	PV_A_B027	2.312	2.125	PV_B_B138	3.375	3.250	PV_A_B042
1.437	1.250	PV_B_B124	2.375	2.250	PV_A_B035	<b>3.375</b>	<b>3.125</b>	<b>PV_C_B235</b>
<b>1.437</b>	<b>1.187</b>	<b>PV_C_B217</b>	2.375	2.187	PV_B_B139	3.375	3.000	PV_D_B337
1.437	1.062	PV_D_B319	<b>2.375</b>	<b>2.125</b>	<b>PV_C_B227</b>	3.375	2.875	PV_E_B412
1.500	1.375	PV_A_B028	2.375	2.000	PV_D_B329	3.437	3.250	PV_B_B152
1.500	1.312	PV_B_B125	2.375	1.875	PV_E_B404	<b>3.500</b>	<b>3.250</b>	<b>PV_C_B236</b>
<b>1.500</b>	<b>1.250</b>	<b>PV_C_B218</b>	2.437	2.250	PV_B_B140	3.500	3.125	PV_D_B338
1.500	1.125	PV_D_B320	2.500	2.375	PV_A_B036	3.500	3.000	PV_E_B413
1.562	1.375	PV_B_B126	2.500	2.312	PV_B_B141	3.625	3.500	PV_A_B043
<b>1.562</b>	<b>1.312</b>	<b>PV_C_B219</b>	<b>2.500</b>	<b>2.250</b>	<b>PV_C_B228</b>	<b>3.625</b>	<b>3.375</b>	<b>PV_C_B237</b>
1.562	1.187	PV_D_B321	2.500	2.125	PV_D_B330	3.625	3.250	PV_D_B339
1.625	1.500	PV_A_B029	2.500	2.000	PV_E_B405	3.625	3.125	PV_E_B414
1.625	1.437	PV_B_B127	2.562	2.375	PV_B_B142	3.688	3.500	PV_B_B153
<b>1.625</b>	<b>1.375</b>	<b>PV_C_B220</b>	2.625	2.500	PV_A_B037	3.750	3.500	PV_C_B238
1.625	1.250	PV_D_B322	2.625	2.437	PV_B_B143	<b>3.750</b>	<b>3.375</b>	<b>PV_D_B340</b>
1.687	1.500	PV_B_B128	<b>2.625</b>	<b>2.375</b>	<b>PV_C_B229</b>	3.750	3.250	PV_E_B415
<b>1.687</b>	<b>1.437</b>	<b>PV_C_B221</b>	2.625	2.250	PV_D_B331	3.875	3.750	PV_A_B044
1.687	1.312	PV_D_B323	2.625	2.125	PV_E_B406	3.875	3.625	PV_C_B239
1.750	1.625	PV_A_B030	2.687	2.500	PV_B_B144	<b>3.875</b>	<b>3.500</b>	<b>PV_D_B341</b>
1.750	1.562	PV_B_B129	2.750	2.625	PV_A_B038	3.875	3.375	PV_E_B416
<b>1.750</b>	<b>1.500</b>	<b>PV_C_B222</b>	2.750	2.562	PV_B_B145	3.937	3.750	PV_B_B154
1.750	1.375	PV_D_B324	<b>2.750</b>	<b>2.500</b>	<b>PV_C_B230</b>	4.000	3.750	PV_C_B240
1.812	1.625	PV_B_B130	2.750	2.375	PV_D_B332	<b>4.000</b>	<b>3.625</b>	<b>PV_D_B342</b>
1.875	1.750	PV_A_B031	2.750	2.250	PV_E_B407	4.000	3.500	PV_E_B417
1.875	1.687	PV_B_B131	2.812	2.625	PV_B_B146	4.125	4.000	PV_A_B045
<b>1.875</b>	<b>1.625</b>	<b>PV_C_B223</b>	2.875	2.750	PV_A_B039	4.125	3.875	PV_C_B241
1.875	1.500	PV_D_B325	2.875	2.687	PV_B_B147	<b>4.125</b>	<b>3.750</b>	<b>PV_D_B343</b>
1.937	1.750	PV_B_B132	<b>2.875</b>	<b>2.625</b>	<b>PV_C_B231</b>	4.125	3.625	PV_E_B418
2.000	1.875	PV_A_B032	2.875	2.500	PV_D_B333	4.187	4.000	PV_B_B155
2.000	1.812	PV_B_B133	2.875	2.375	PV_E_B408	4.250	4.000	PV_C_B242
<b>2.000</b>	<b>1.750</b>	<b>PV_C_B224</b>	2.937	2.750	PV_B_B148	<b>4.250</b>	<b>3.875</b>	<b>PV_D_B344</b>
2.000	1.625	PV_D_B326	3.000	2.875	PV_A_B040	4.250	3.750	PV_E_B419
2.000	1.500	PV_E_B401	3.000	2.812	PV_B_B149	4.375	4.125	PV_C_B243
2.062	1.875	PV_B_B134	<b>3.000</b>	<b>2.750</b>	<b>PV_C_B232</b>	<b>4.375</b>	<b>4.000</b>	<b>PV_D_B345</b>
2.125	2.000	PV_A_B033	3.000	2.625	PV_D_B334	4.375	3.875	PV_E_B420
2.125	1.937	PV_B_B135	3.000	2.500	PV_E_B409	4.437	4.250	PV_B_B156



D <sub>N</sub>	d <sub>1</sub>	TSS Part No.	D <sub>N</sub>	d <sub>1</sub>	TSS Part No.	D <sub>N</sub>	d <sub>1</sub>	TSS Part No.
4.500	4.250	PV_C_B244	5.750	5.375	PV_D_B356	8.125	7.750	PV_D_B368
<b>4.500</b>	<b>4.125</b>	<b>PV_D_B346</b>	<b>5.750</b>	<b>5.250</b>	<b>PV_E_B431</b>	8.250	8.000	PV_C_B266
4.500	4.000	PV_E_B421	5.875	5.625	PV_C_B255	<b>8.250</b>	<b>7.750</b>	<b>PV_E_B444</b>
4.625	4.375	PV_C_B245	5.875	5.500	PV_D_B357	8.375	8.000	PV_D_B369
<b>4.625</b>	<b>4.250</b>	<b>PV_D_B347</b>	<b>5.875</b>	<b>5.375</b>	<b>PV_E_B432</b>	8.500	8.250	PV_C_B267
4.625	4.125	PV_E_B422	6.000	5.750	PV_C_B256	<b>8.500</b>	<b>8.000</b>	<b>PV_E_B445</b>
4.687	4.500	PV_B_B157	6.000	5.625	PV_D_B358	8.625	8.250	PV_D_B370
4.750	4.500	PV_C_B246	<b>6.000</b>	<b>5.500</b>	<b>PV_E_B433</b>	8.750	8.500	PV_C_B268
<b>4.750</b>	<b>4.375</b>	<b>PV_D_B348</b>	6.125	5.875	PV_C_B257	8.875	8.500	PV_D_B371
4.750	4.250	PV_E_B423	6.125	5.750	PV_D_B359	9.000	8.750	PV_C_B269
4.875	4.625	PV_C_B247	<b>6.125</b>	<b>5.625</b>	<b>PV_E_B434</b>	<b>9.000</b>	<b>8.500</b>	<b>PV_E_B446</b>
<b>4.875</b>	<b>4.500</b>	<b>PV_D_B349</b>	6.250	6.000	PV_C_B258	9.125	8.750	PV_D_B372
4.875	4.375	PV_E_B424	6.250	5.875	PV_D_B360	9.250	9.000	PV_C_B270
4.937	4.750	PV_B_B158	<b>6.250</b>	<b>5.750</b>	<b>PV_E_B435</b>	9.375	9.000	PV_D_B373
5.000	4.750	PV_C_B248	6.375	6.000	PV_D_B361	<b>9.500</b>	<b>9.000</b>	<b>PV_E_B447</b>
<b>5.000</b>	<b>4.625</b>	<b>PV_D_B350</b>	<b>6.375</b>	<b>5.875</b>	<b>PV_E_B436</b>	9.625	9.250	PV_D_B374
5.000	4.500	PV_E_B425	6.500	6.250	PV_C_B259	9.875	9.500	PV_D_B375
5.125	4.875	PV_C_B249	<b>6.500</b>	<b>6.000</b>	<b>PV_E_B437</b>	<b>10.000</b>	<b>9.500</b>	<b>PV_E_B448</b>
<b>5.125</b>	<b>4.750</b>	<b>PV_D_B351</b>	6.625	6.250	PV_D_B362	10.125	9.750	PV_D_B376
5.125	4.625	PV_E_B426	6.750	6.500	PV_C_B260	10.375	10.000	PV_D_B377
5.187	5.000	PV_B_B159	<b>6.750</b>	<b>6.250</b>	<b>PV_E_B438</b>	<b>10.500</b>	<b>10.000</b>	<b>PV_E_B449</b>
5.250	5.000	PV_C_B250	6.875	6.500	PV_D_B363	10.875	10.500	PV_D_B378
<b>5.250</b>	<b>4.875</b>	<b>PV_D_B352</b>	7.000	6.750	PV_C_B261	<b>11.000</b>	<b>10.500</b>	<b>PV_E_B450</b>
5.250	4.750	PV_E_B427	<b>7.000</b>	<b>6.500</b>	<b>PV_E_B439</b>	<b>11.500</b>	<b>11.000</b>	<b>PV_E_B451</b>
5.375	5.125	PV_C_B251	7.125	6.750	PV_D_B364	<b>12.000</b>	<b>11.500</b>	<b>PV_E_B452</b>
<b>5.375</b>	<b>5.000</b>	<b>PV_D_B353</b>	7.250	7.000	PV_C_B262	<b>12.500</b>	<b>12.000</b>	<b>PV_E_B453</b>
5.375	4.875	PV_E_B428	<b>7.250</b>	<b>6.750</b>	<b>PV_E_B440</b>	<b>13.000</b>	<b>12.500</b>	<b>PV_E_B454</b>
5.437	5.250	PV_B_B160	7.375	7.000	PV_D_B365	<b>13.500</b>	<b>13.000</b>	<b>PV_E_B455</b>
5.500	5.250	PV_C_B252	7.500	7.250	PV_C_B263	<b>14.000</b>	<b>13.500</b>	<b>PV_E_B456</b>
5.500	5.125	PV_D_B354	<b>7.500</b>	<b>7.000</b>	<b>PV_E_B441</b>	<b>14.500</b>	<b>14.000</b>	<b>PV_E_B457</b>
<b>5.500</b>	<b>5.000</b>	<b>PV_E_B429</b>	7.625	7.250	PV_D_B366	<b>15.000</b>	<b>14.500</b>	<b>PV_E_B458</b>
5.625	5.375	PV_C_B253	7.750	7.500	PV_C_B264	<b>15.500</b>	<b>15.000</b>	<b>PV_E_B459</b>
5.625	5.250	PV_D_B355	<b>7.750</b>	<b>7.250</b>	<b>PV_E_B442</b>	<b>16.000</b>	<b>15.500</b>	<b>PV_E_B460</b>
<b>5.625</b>	<b>5.125</b>	<b>PV_E_B430</b>	7.875	7.500	PV_D_B367			
5.687	5.500	PV_B_B161	8.000	7.750	PV_C_B265			
5.750	5.500	PV_C_B254	<b>8.000</b>	<b>7.500</b>	<b>PV_E_B443</b>			

For additional size and part number details please contact your local Trelleborg Sealing Solutions Marketing company.

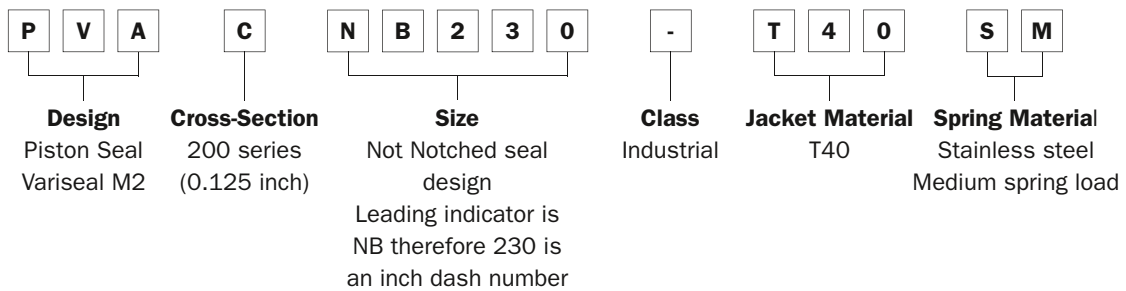



**Table 26: Part Number System for Piston Variseal® – Inch**

Article Code	Cross-Section	Size	Class	Seal Material	Spring Material	Spring Load
<b>PVA</b> Variseal M2	<b>Inch</b>	<b>With Notches</b>	- Industrial	<b>T01</b>	<b>S</b> Stainless Steel	<b>Standard load for each design</b>
<b>PVC</b> Variseal M2S	<b>A</b> 0.062	<b>OBxxx</b> Inch Dash #	<b>A</b> Aerospace	<b>MF1</b>	<b>H</b> Hastelloy	
<b>PVE</b> Variseal H	<b>B</b> 0.093	<b>Sxxxx</b> Bore dia <10.0 Inch (dia x 1000.0)		<b>MF4</b>	<b>E</b> Elgiloy	<b>PVA &amp; PVC</b>
<b>PVJ</b> Variseal W2	<b>C</b> 0.125	<b>Lxxxx</b> Bore dia. >= 10.0 (dia x 100.0)		<b>MF6</b>		
	<b>D</b> 0.187			<b>T05</b>		<b>M</b> Medium
	<b>E</b> 0.250			<b>T07</b> See page 7		<b>R</b> High Clean
	<b>G</b> 0.375			<b>T12</b> for material		<b>PVE</b>
		<b>No Notches</b>		<b>T24</b> description		
		<b>NBxxx</b> Inch Dash #		<b>T40</b>		<b>H</b> Heavy
		<b>Rxxxx</b> Bore dia <10.0 Inch (dia x 1000.0)		<b>M79</b>		<b>PVJ</b>
		<b>Kxxxx</b> Bore dia. >= 10.0 (dia x 100.0)		<b>Z48</b>		
				<b>Z80</b>		<b>M</b> Medium

**ORDERING EXAMPLE 1**



**ORDERING EXAMPLE 2**

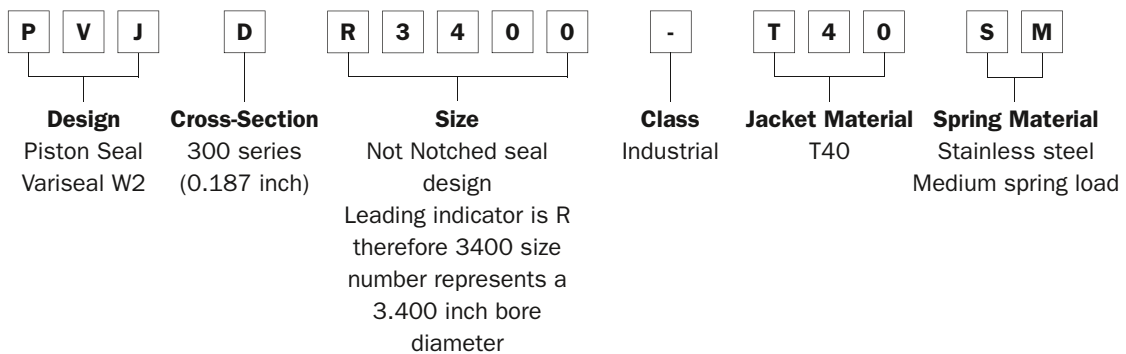



## ■ Installation Recommendations for AS4716 Piston Seals – Types M2, M2S, W2 and H – Inch

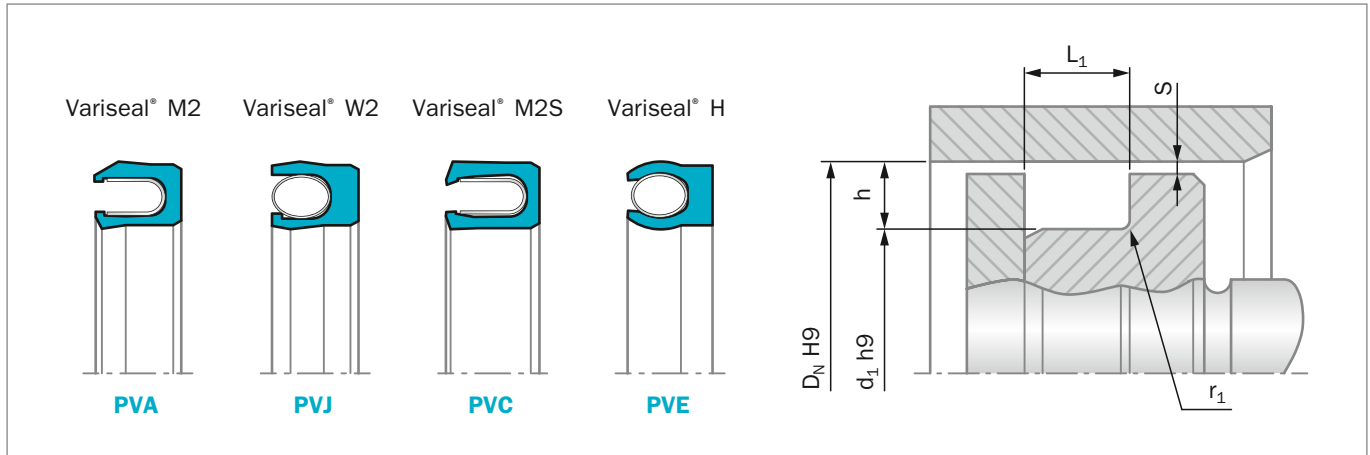

Figure 23: Installation Drawing

**Table 27: Installation Dimensions AS4716 – Inch**

Series Number for Types				h Groove Depth	L <sub>1</sub> Groove Width +0.010	r <sub>1</sub> Radius Max	Radial Clearance Smax			
M2	M2S	W2	H				290 psi	1,450 psi	2,900 psi	5,800 psi
PVA0	PVC0	PVJ0	PVE0	0.056	0.094	0.010	0.008	0.004	0.003	0.002
PVA1	PVC1	PVJ1	PVE1	0.087	0.141	0.015	0.010	0.006	0.004	0.003
PVA2	PVC2	PVJ2	PVE2	0.122	0.188	0.015	0.014	0.008	0.006	0.003
PVA3	PVC3	PVJ3	PVE3	0.185	0.281	0.015	0.020	0.010	0.008	0.004
PVA4	PVC4	PVJ4	PVE4	0.239	0.375	0.020	0.024	0.012	0.010	0.005

AS4716 states hardware tolerances to h8/H8. However Variseals are suitable with h9/H9 tolerances. h9/H9 tolerances can be found using the ISO Fits & Tolerances App, see page 88.

**Table 28: Standard Dash Sizes AS4716 – Inch**

D <sub>N</sub>	d <sub>1</sub>	TSS Part No.	D <sub>N</sub>	d <sub>1</sub>	TSS Part No.	D <sub>N</sub>	d <sub>1</sub>	TSS Part No.
<b>0.235</b>	<b>0.123</b>	<b>PV_0_M006</b>	0.613	0.504	PV_0_M014	<b>0.991</b>	<b>0.817</b>	<b>PV_1_M117</b>
<b>0.266</b>	<b>0.154</b>	<b>PV_0_M007</b>	<b>0.613</b>	<b>0.441</b>	<b>PV_1_M111</b>	0.991	0.750	PV_2_M210
<b>0.297</b>	<b>0.189</b>	<b>PV_0_M008</b>	0.675	0.566	PV_0_M015	1.053	0.943	PV_0_M021
<b>0.329</b>	<b>0.220</b>	<b>PV_0_M009</b>	<b>0.675</b>	<b>0.502</b>	<b>PV_1_M112</b>	<b>1.053</b>	<b>0.879</b>	<b>PV_1_M118</b>
0.360	0.250	PV_0_M010	0.738	0.629	PV_0_M016	1.053	0.812	PV_2_M211
0.360	0.187	PV_1_M106	<b>0.800</b>	<b>0.565</b>	<b>PV_1_M113</b>	1.116	1.006	PV_0_M022
0.391	0.225	PV_1_M107	0.800	0.691	PV_0_M017	<b>1.116</b>	<b>0.942</b>	<b>PV_1_M119</b>
0.422	0.312	PV_0_M011	<b>0.800</b>	<b>0.627</b>	<b>PV_1_M114</b>	1.116	0.874	PV_2_M212
<b>0.422</b>	<b>0.256</b>	<b>PV_1_M108</b>	0.863	0.753	PV_0_M018	1.178	1.068	PV_0_M023
0.485	0.375	PV_0_M012	<b>0.863</b>	<b>0.689</b>	<b>PV_1_M115</b>	1.178	1.003	PV_1_M120
<b>0.485</b>	<b>0.308</b>	<b>PV_1_M109</b>	0.925	0.815	PV_0_M019	1.178	0.936	PV_2_M213
0.550	0.441	PV_0_M013	<b>0.925</b>	<b>0.751</b>	<b>PV_1_M116</b>	1.241	1.131	PV_0_M024
<b>0.550</b>	<b>0.379</b>	<b>PV_1_M110</b>	0.991	0.881	PV_0_M020	1.241	1.066	PV_1_M121



D <sub>N</sub>	d <sub>1</sub>	TSS Part No.	D <sub>N</sub>	d <sub>1</sub>	TSS Part No.	D <sub>N</sub>	d <sub>1</sub>	TSS Part No.
<b>1.241</b>	<b>0.999</b>	<b>PV_2_M214</b>	2.493	2.121	PV_3_M330	<b>4.743</b>	<b>4.371</b>	<b>PV_3_M348</b>
1.303	1.193	PV_0_M025	2.555	2.381	PV_1_M142	<b>4.868</b>	<b>4.496</b>	<b>PV_3_M349</b>
1.303	1.128	PV_1_M122	2.618	2.444	PV_1_M143	4.974	4.497	PV_4_M425
<b>1.303</b>	<b>1.061</b>	<b>PV_2_M215</b>	<b>2.618</b>	<b>2.376</b>	<b>PV_2_M229</b>	<b>5.099</b>	<b>4.622</b>	<b>PV_4_M426</b>
1.366	1.256	PV_0_M026	2.618	2.246	PV_3_M331	<b>5.224</b>	<b>4.747</b>	<b>PV_4_M427</b>
1.366	1.191	PV_1_M123	2.680	2.506	PV_1_M144	<b>5.349</b>	<b>4.872</b>	<b>PV_4_M428</b>
<b>1.366</b>	<b>1.124</b>	<b>PV_2_M216</b>	2.743	2.569	PV_1_M145	<b>5.474</b>	<b>4.997</b>	<b>PV_4_M429</b>
1.428	1.318	PV_0_M027	<b>2.743</b>	<b>2.501</b>	<b>PV_2_M230</b>	<b>5.599</b>	<b>5.122</b>	<b>PV_4_M430</b>
1.428	1.253	PV_1_M124	2.743	2.371	PV_3_M332	<b>5.724</b>	<b>5.247</b>	<b>PV_4_M431</b>
<b>1.428</b>	<b>1.186</b>	<b>PV_2_M217</b>	2.805	2.631	PV_1_M146	<b>5.849</b>	<b>5.372</b>	<b>PV_4_M432</b>
1.491	1.381	PV_0_M028	2.867	2.693	PV_1_M147	<b>5.974</b>	<b>5.497</b>	<b>PV_4_M433</b>
1.491	1.316	PV_1_M125	<b>2.867</b>	<b>2.626</b>	<b>PV_2_M231</b>	<b>6.099</b>	<b>5.622</b>	<b>PV_4_M434</b>
<b>1.491</b>	<b>1.249</b>	<b>PV_2_M218</b>	2.867	2.496	PV_3_M333	<b>6.224</b>	<b>5.747</b>	<b>PV_4_M435</b>
1.553	1.378	PV_1_M126	2.930	2.756	PV_1_M148	<b>6.349</b>	<b>5.872</b>	<b>PV_4_M436</b>
<b>1.553</b>	<b>1.311</b>	<b>PV_2_M219</b>	2.993	2.819	PV_1_M149	<b>6.474</b>	<b>5.997</b>	<b>PV_4_M437</b>
1.616	1.441	PV_1_M127	<b>2.993</b>	<b>2.751</b>	<b>PV_2_M232</b>	<b>6.724</b>	<b>6.247</b>	<b>PV_4_M438</b>
<b>1.616</b>	<b>1.374</b>	<b>PV_2_M220</b>	2.993	2.621	PV_3_M334	<b>6.974</b>	<b>6.497</b>	<b>PV_4_M439</b>
1.678	1.503	PV_1_M128	<b>3.118</b>	<b>2.876</b>	<b>PV_2_M233</b>	<b>7.224</b>	<b>6.747</b>	<b>PV_4_M440</b>
<b>1.678</b>	<b>1.436</b>	<b>PV_2_M221</b>	3.118	2.746	PV_3_M335	<b>7.474</b>	<b>6.997</b>	<b>PV_4_M441</b>
1.741	1.566	PV_1_M129	<b>3.243</b>	<b>3.001</b>	<b>PV_2_M234</b>	<b>7.724</b>	<b>7.247</b>	<b>PV_4_M442</b>
<b>1.741</b>	<b>1.499</b>	<b>PV_2_M222</b>	3.243	2.871	PV_3_M336	<b>7.974</b>	<b>7.497</b>	<b>PV_4_M443</b>
1.805	1.631	PV_1_M130	<b>3.368</b>	<b>3.126</b>	<b>PV_2_M235</b>	<b>8.224</b>	<b>7.747</b>	<b>PV_4_M444</b>
1.867	1.693	PV_1_M131	3.368	2.996	PV_3_M337	<b>8.474</b>	<b>7.997</b>	<b>PV_4_M445</b>
<b>1.867</b>	<b>1.625</b>	<b>PV_2_M223</b>	<b>3.493</b>	<b>3.251</b>	<b>PV_2_M236</b>	<b>8.974</b>	<b>8.497</b>	<b>PV_4_M446</b>
1.867	1.495	PV_3_M325	3.493	3.121	PV_3_M338	<b>9.474</b>	<b>8.997</b>	<b>PV_4_M447</b>
1.930	1.756	PV_1_M132	3.618	3.376	PV_2_M237	<b>9.974</b>	<b>9.497</b>	<b>PV_4_M448</b>
1.992	1.818	PV_1_M133	3.618	3.246	PV_3_M339	<b>10.474</b>	<b>9.997</b>	<b>PV_4_M449</b>
<b>1.992</b>	<b>1.750</b>	<b>PV_2_M224</b>	3.743	3.501	PV_2_M238	<b>10.974</b>	<b>10.497</b>	<b>PV_4_M450</b>
1.992	1.620	PV_3_M326	<b>3.743</b>	<b>3.371</b>	<b>PV_3_M340</b>	<b>11.474</b>	<b>10.997</b>	<b>PV_4_M451</b>
2.055	1.881	PV_1_M134	3.868	3.626	PV_2_M239	<b>11.974</b>	<b>11.497</b>	<b>PV_4_M452</b>
2.118	1.944	PV_1_M135	<b>3.868</b>	<b>3.496</b>	<b>PV_3_M341</b>	<b>12.474</b>	<b>11.997</b>	<b>PV_4_M453</b>
<b>2.180</b>	<b>1.876</b>	<b>PV_2_M225</b>	3.993	3.751	PV_2_M240	<b>12.974</b>	<b>12.497</b>	<b>PV_4_M454</b>
2.180	1.746	PV_3_M327	<b>3.993</b>	<b>3.621</b>	<b>PV_3_M342</b>	<b>13.474</b>	<b>12.997</b>	<b>PV_4_M455</b>
2.180	2.006	PV_1_M136	4.118	3.876	PV_2_M241	<b>13.974</b>	<b>13.497</b>	<b>PV_4_M456</b>
2.243	2.069	PV_1_M137	<b>4.118</b>	<b>3.746</b>	<b>PV_3_M343</b>	<b>14.474</b>	<b>13.997</b>	<b>PV_4_M457</b>
<b>2.243</b>	<b>2.001</b>	<b>PV_2_M226</b>	4.243	4.001	PV_2_M242	<b>14.974</b>	<b>14.497</b>	<b>PV_4_M458</b>
2.243	1.871	PV_3_M328	4.243	<b>3.871</b>	<b>PV_3_M344</b>	<b>15.474</b>	<b>14.997</b>	<b>PV_4_M459</b>
2.305	2.131	PV_1_M138	4.368	4.126	PV_2_M243	<b>15.974</b>	<b>15.497</b>	<b>PV_4_M460</b>
2.368	2.194	PV_1_M139	<b>4.368</b>	<b>3.996</b>	<b>PV_3_M345</b>			
<b>2.368</b>	<b>2.126</b>	<b>PV_2_M227</b>	4.493	4.251	PV_2_M244			
2.368	1.996	PV_3_M329	<b>4.493</b>	<b>4.121</b>	<b>PV_3_M346</b>			
2.430	2.256	PV_1_M140	4.618	4.376	PV_2_M245			
2.493	2.319	PV_1_M141	<b>4.618</b>	<b>4.246</b>	<b>PV_3_M347</b>			
<b>2.493</b>	<b>2.251</b>	<b>PV_2_M228</b>	4.743	4.501	PV_2_M246			

Figures in **bold** are preferred sizes.  
For additional size and part number details please contact your local Trelleborg Sealing Solutions Marketing company.



**Table 29: Part Number System for Piston Variseal® – Inch / AS4716**

Article Code	Cross-Section	Size	Class	Seal Material	Spring Material	Spring Load
<b>PVA</b> Variseal M2	<b>AS4716</b>	<b>With Notches</b>	- Industrial	<b>T01</b>	<b>S</b> Stainless Steel	<b>Standard load for each design</b>
<b>PVC</b> Variseal M2S	<b>0</b> 0.056	<b>OMxxx</b> AS4716 Dash #	<b>A</b> Aerospace	<b>MF1</b>	<b>H</b> Hastelloy	
<b>PVE</b> Variseal H	<b>1</b> 0.087	<b>Sxxxx</b> Bore dia <10.0 Inch (dia x 1000.0)		<b>MF4</b>	<b>E</b> Elgiloy	<b>PVA &amp; PVC</b>
<b>PVJ</b> Variseal W2	<b>2</b> 0.122	<b>Lxxxx</b> Bore dia. >= 10.0 (dia x 100.0)		<b>MF6</b>		<b>M</b> Medium
	<b>3</b> 0.185	<b>No Notches</b>		<b>T05</b>		<b>R</b> High Clean
	<b>4</b> 0.239	<b>NMxxx</b> AS4716 Dash #		<b>T07</b> See page 7		<b>PVE</b>
		<b>Rxxxx</b> Bore dia <10.0 Inch (dia x 1000.0)		<b>T12</b> for material		<b>H</b> Heavy
		<b>Kxxxx</b> Bore dia. >= 10.0 (dia x 100.0)		<b>T24</b> description		<b>PVJ</b>
				<b>T40</b>		<b>M</b> Medium
				<b>M79</b>		
				<b>Z48</b>		
				<b>Z80</b>		

**ORDERING EXAMPLE 1**

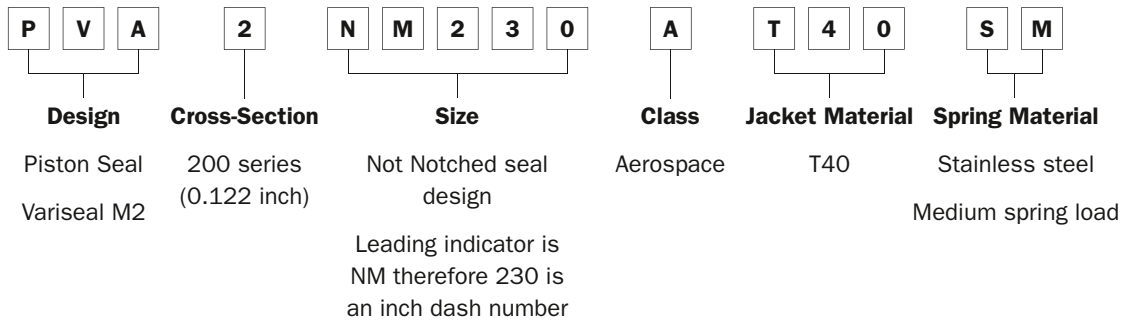

**ORDERING EXAMPLE 2**

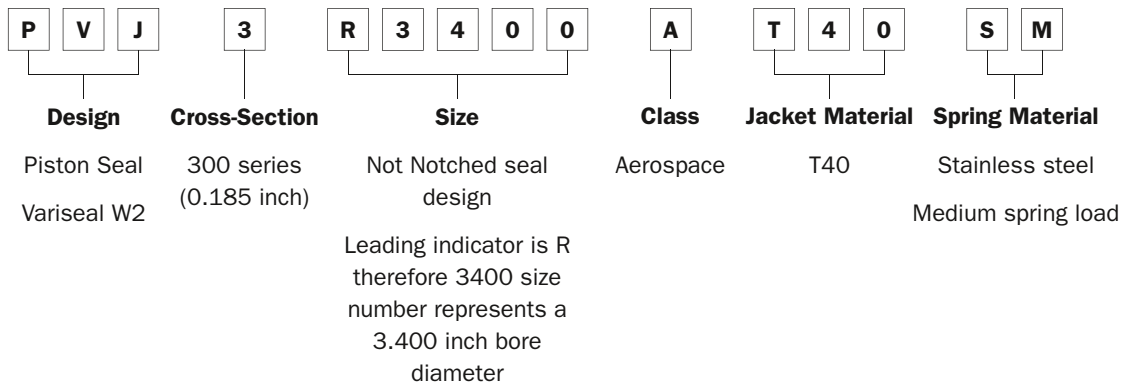

---

! This page is intentionally left blank.



## Turcon® Variseal® HF

### DESCRIPTION

Turcon® Variseal® **HF** is the standard seal for axial (face) applications. It has a high spring loading, which gives excellent sealing integrity at low pressure and is available for both internal and external pressure.

The heavy helical spring in Variseal® HF makes it the best choice for vacuum, gas and low temperature flange sealing applications.

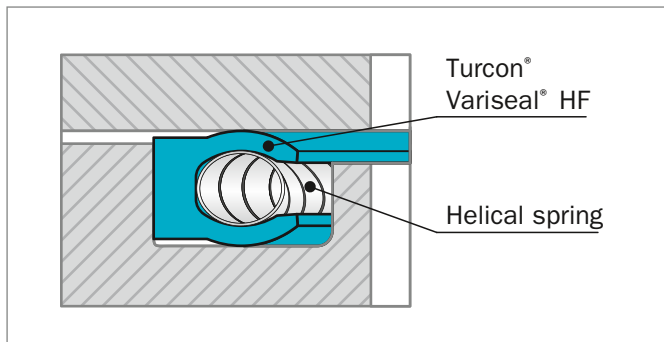

Figure 24: Turcon® Variseal® HF

### AREAS OF APPLICATION

- Compressor housings
- Construction equipment and plant
- Chemical processing
- Crude oil and natural gas installations
- Cryogenic engineering
- Nuclear power
- Vacuum applications
- Pivot joints

### TECHNICAL DATA

<b>Operating pressure:</b>	Maximum static load: 60 MPa / 8,702 psi Maximum dynamic load: 20 MPa / 2,900 psi (207 MPa / 30,000 psi with Back-up Ring)
<b>Speed:</b>	Static to slow rotating or pivoting movements
<b>Operating temperature:</b>	-150 °C to +200 °C / -238 °F to +392 °F
<b>Media compatibility:</b>	Virtually all fluids, chemicals compatibility: and gases

### IMPORTANT NOTE

The above data are maximum values and cannot be used at the same time. e.g. the maximum operating speed depends on material type, pressure, temperature and gap value.  
Temperature range also dependent on media.

---

! This page is intentionally left blank.



## ■ Installation Recommendations for Internal Face Seals – Type HF – Metric

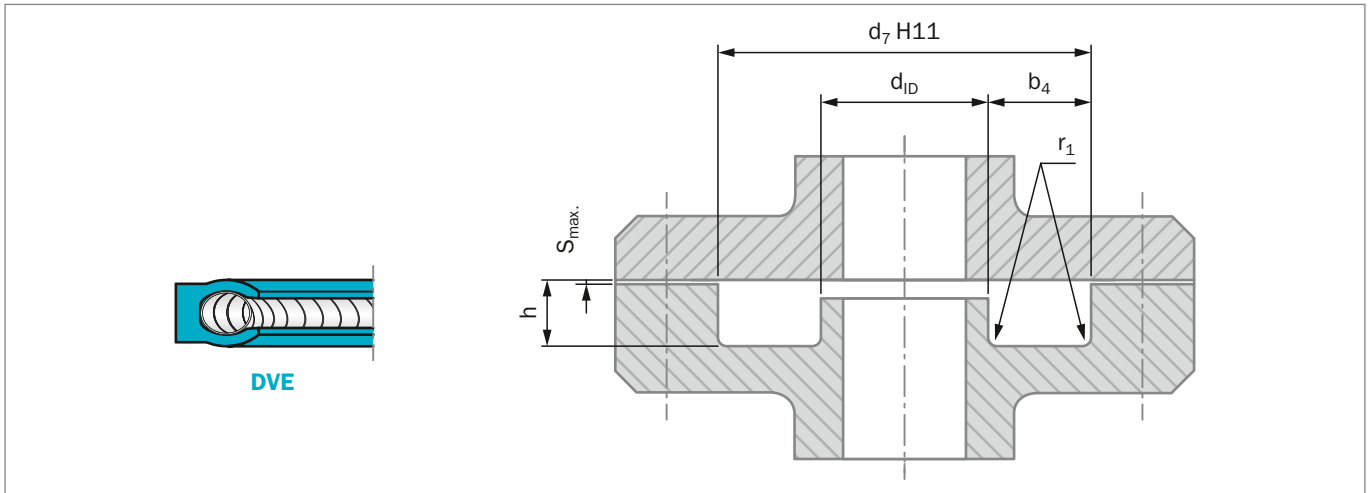

Figure 25: Installation Drawing

**Table 30: Installation Dimensions – Metric**

Series No.	Groove Outside Diameter $d_7$ H11		h		$b_4$ Groove Width Min	$r_1$ Radius Max	Axial Clearance $S_{max}$			
			Groove Depth				2 MPa	10 MPa	20 MPa	40 MPa
	Standard Range	Extended Range <sup>1)</sup>								
DVE0	10.0 - 13.9	10.0 - 40.0	1.45	+0.03	2.40	0.25	0.20	0.10	0.08	0.05
DVE1	14.0 - 24.9	13.0 - 200.0	2.25	+0.05	3.60	0.38	0.25	0.15	0.10	0.07
DVE2	25.0 - 45.9	18.0 - 400.0	3.10	+0.08	4.80	0.38	0.35	0.20	0.15	0.08
DVE3	46.0 - 124.9	28.0 - 700.0*	4.70	+0.10	7.10*	0.38	0.50	0.25	0.20	0.10
DVE4	125.0 - 999.9**	45.0 - 1000.0**	6.10	+0.15	9.50**	0.51	0.60	0.30	0.25	0.12
DVE5	1000.0 - 2500.0***	110.0 - 2500.0***	9.50	+0.20	15.00***	0.51	0.90	0.50	0.40	0.20

\* For diameters above 700 mm  $b_4$  min. = 8.0 mm  
 \*\* For diameters above 700 mm  $b_4$  min. = 11.0 mm  
 \*\*\* For diameters above 1000 mm  $b_4$  min. = 18.0 mm

<sup>1)</sup> Available on request  
 H11 tolerance can be found using the ISO Fits & Tolerance App, see page 88.

**Table 31: Size Series – Metric**

$d_7$	$d_{ID}$ max	TSS Part No.	$d_7$	$d_{ID}$ max	TSS Part No.	$d_7$	$d_{ID}$ max	TSS Part No.
10.0	5.2	DVE000100	45.0	35.4	DVE200450	105.0	90.8	DVE301050
12.0	7.2	DVE000120	48.0	33.8	DVE300480	110.0	95.8	DVE301100
14.0	6.8	DVE100140	50.0	35.8	DVE300500	115.0	100.8	DVE301150
15.0	7.8	DVE100150	52.0	37.8	DVE300520	120.0	105.8	DVE301200
16.0	8.8	DVE100160	55.0	40.8	DVE300550	122.0	107.8	DVE301220
18.0	10.8	DVE100180	56.0	41.8	DVE300560	125.0	106.0	DVE401250
20.0	12.8	DVE100200	60.0	45.8	DVE300600	130.0	111.0	DVE401300
22.0	14.8	DVE100220	63.0	48.8	DVE300630	135.0	116.0	DVE401350
25.0	15.4	DVE200250	65.0	50.8	DVE300650	140.0	121.0	DVE401400
28.0	18.4	DVE200280	70.0	55.8	DVE300700	150.0	131.0	DVE401500
30.0	20.4	DVE200300	75.0	60.8	DVE300750	160.0	141.0	DVE401600
32.0	22.4	DVE200320	80.0	65.8	DVE300800	170.0	151.0	DVE401700
35.0	25.4	DVE200350	85.0	70.8	DVE300850	180.0	161.0	DVE401800
36.0	26.4	DVE200360	90.0	75.8	DVE300900			
40.0	30.4	DVE200400	95.0	80.8	DVE300950			
42.0	32.4	DVE200420	100.0	85.8	DVE301000			

For additional size and part number details please contact your local Trelleborg Sealing Solutions Marketing company.

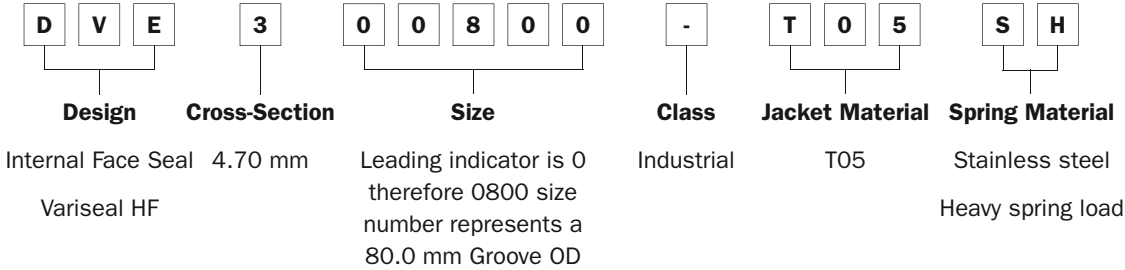



**Table 32: Part Number Systems for Internal Face Seals – Metric**

Article Code	Cross-Section	Size	Class	Seal Material	Spring Material	Spring Load
<b>DVE</b> Variseal HF (Internal)	<b>0</b> 1.45 <b>1</b> 2.25 <b>2</b> 3.10 <b>3</b> 4.70 <b>4</b> 6.10 <b>5</b> 9.50	<b>0xxxx</b> Groove OD <1000 (dia x 10.0) <b>Xxxxx</b> Groove OD >= 1000 (dia x 1.0)	- Industrial <b>A</b> Aerospace	<b>T01</b> <b>MF1</b> <b>MF4</b> <b>MF6</b> <b>T05</b> <b>T07</b> See page 7 <b>T12</b> for material <b>T24</b> description <b>T40</b> <b>M79</b> <b>Z48</b> <b>Z80</b>	<b>S</b> Stainless Steel <b>H</b> Hastelloy <b>E</b> Elgiloy	<b>Standard load for each design</b> <b>H</b> Heavy

**ORDERING EXAMPLE 1**



**ORDERING EXAMPLE 2**

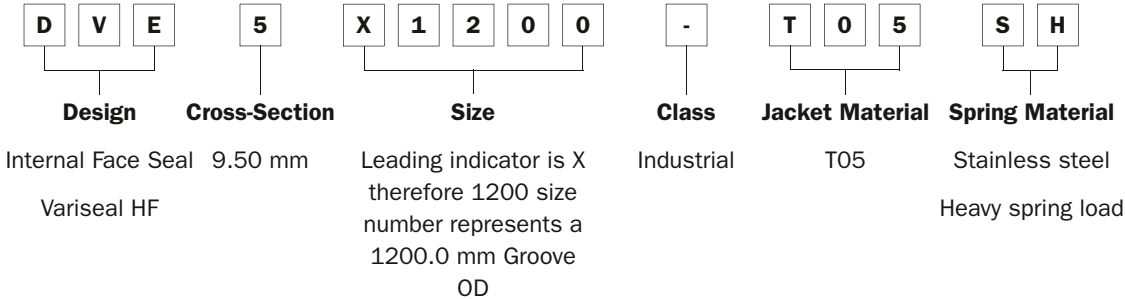



## ■ Installation Recommendations for Internal Face Seals – Type HF – Inch

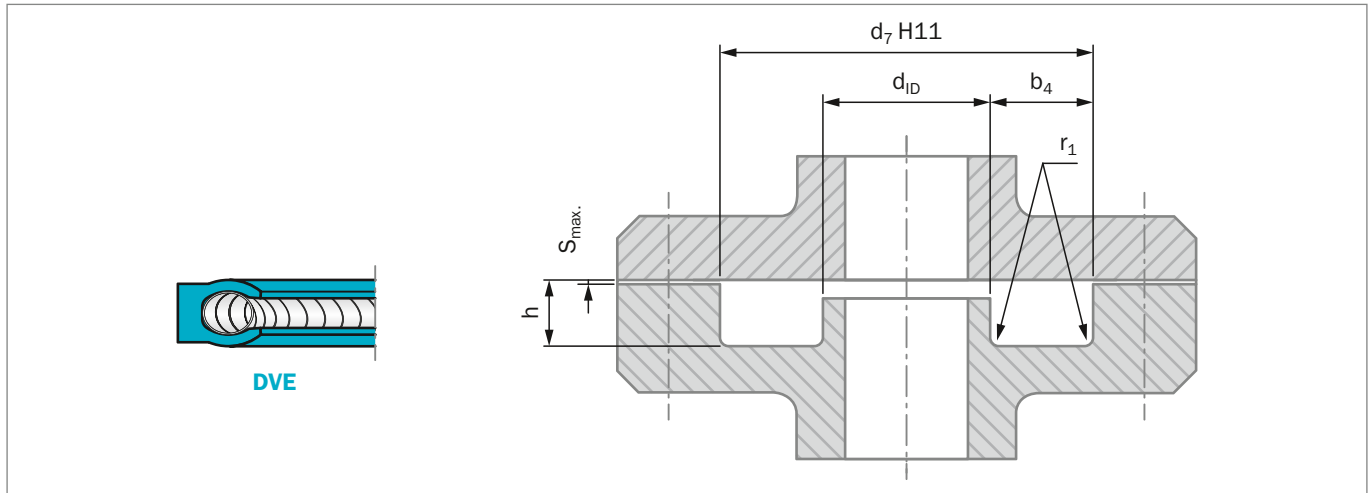

Figure 26: Installation Drawing

**Table 33: Installation Dimensions – Inch**

Series No.	h		b <sub>4</sub> Groove Width Min	r <sub>1</sub> Radius Max	Axial Clearance S <sub>max</sub>			
	Groove Depth				290 psi	1,450 psi	2,900 psi	5,800 psi
DVE0	0.057	+ 0.002	0.094	0.010	0.008	0.004	0.003	0.002
DVE1	0.089	+ 0.002	0.141	0.015	0.010	0.006	0.004	0.003
DVE2	0.122	+ 0.002	0.188	0.015	0.014	0.008	0.006	0.003
DVE3	0.186	+ 0.002	0.281	0.015	0.020	0.010	0.008	0.004
DVE4	0.238	+ 0.002	0.375	0.020	0.024	0.012	0.010	0.005
DVE5	0.374	+ 0.004	0.591	0.020	0.030	0.015	0.012	0.006

H11 tolerance can be found using the ISO Fits & Tolerance App, see page 88.

**Table 34: Standard Dash Sizes – Inch**

d <sub>7</sub>	d <sub>ID</sub> max	TSS Part No.	d <sub>7</sub>	d <sub>ID</sub> max	TSS Part No.	d <sub>7</sub>	d <sub>ID</sub> max	TSS Part No.
<b>0.500</b>	<b>0.313</b>	<b>DVE00M012</b>	1.250	0.688	DVE30M316	1.750	1.188	DVE30M324
<b>0.625</b>	<b>0.438</b>	<b>DVE00M014</b>	1.375	1.188	DVE00M026	1.875	1.688	DVE00M031
0.750	0.563	DVE00M016	1.375	1.093	DVE10M123	1.875	1.593	DVE10M131
<b>0.750</b>	<b>0.468</b>	<b>DVE10M113</b>	<b>1.375</b>	<b>1.000</b>	<b>DVE20M216</b>	<b>1.875</b>	<b>1.500</b>	<b>DVE20M223</b>
0.875	0.688	DVE00M018	1.375	0.813	DVE30M318	1.875	1.313	DVE30M325
<b>0.875</b>	<b>0.593</b>	<b>DVE10M115</b>	1.500	1.313	DVE00M028	2.000	1.813	DVE00M032
0.875	0.500	DVE20M208	1.500	1.218	DVE10M125	2.000	1.718	DVE10M133
1.000	0.813	DVE00M020	<b>1.500</b>	<b>1.125</b>	<b>DVE20M218</b>	<b>2.000</b>	<b>1.625</b>	<b>DVE20M224</b>
<b>1.000</b>	<b>0.718</b>	<b>DVE10M117</b>	1.500	0.938	DVE30M320	2.000	1.438	DVE30M326
1.000	0.625	DVE20M210	1.625	1.438	DVE00M029	2.000	1.250	DVE40M401
1.125	0.938	DVE00M022	1.625	1.343	DVE10M127	2.125	1.938	DVE00M033
<b>1.125</b>	<b>0.843</b>	<b>DVE10M119</b>	<b>1.625</b>	<b>1.250</b>	<b>DVE20M220</b>	2.125	1.843	DVE10M135
1.125	0.750	DVE20M212	1.625	1.063	DVE30M322	<b>2.125</b>	<b>1.750</b>	<b>DVE20M225</b>
1.250	1.063	DVE00M024	1.750	1.563	DVE00M030	2.125	1.563	DVE30M327
1.250	0.968	DVE10M121	1.750	1.468	DVE10M129	2.125	1.375	DVE40M402
<b>1.250</b>	<b>0.875</b>	<b>DVE20M214</b>	<b>1.750</b>	<b>1.375</b>	<b>DVE20M222</b>	2.250	2.063	DVE00M034



d <sub>7</sub>	d <sub>ID</sub> max	TSS Part No.	d <sub>7</sub>	d <sub>ID</sub> max	TSS Part No.	d <sub>7</sub>	d <sub>ID</sub> max	TSS Part No.
2.250	1.968	DVE10M137	3.625	3.438	DVE00M043	6.000	5.625	DVE20M256
<b>2.250</b>	<b>1.875</b>	<b>DVE20M226</b>	3.625	3.250	DVE20M237	6.000	5.438	DVE30M358
2.250	1.688	DVE30M328	3.625	3.063	DVE30M339	<b>6.000</b>	<b>5.250</b>	<b>DVE40M433</b>
2.250	1.500	DVE40M403	3.625	2.875	DVE40M414	6.250	5.875	DVE20M258
2.375	2.188	DVE00M035	3.750	3.375	DVE20M238	6.250	5.688	DVE30M360
2.375	2.093	DVE10M139	<b>3.750</b>	<b>3.188</b>	<b>DVE30M340</b>	<b>6.250</b>	<b>5.500</b>	<b>DVE40M435</b>
<b>2.375</b>	<b>2.000</b>	<b>DVE20M227</b>	3.750	3.000	DVE40M415	6.500	6.125	DVE20M259
2.375	1.813	DVE30M329	3.875	3.688	DVE00M044	<b>6.500</b>	<b>5.750</b>	<b>DVE40M437</b>
2.375	1.625	DVE40M404	3.875	3.500	DVE20M239	6.750	6.375	DVE20M260
2.500	2.313	DVE00M036	<b>3.875</b>	<b>3.313</b>	<b>DVE30M341</b>	<b>6.750</b>	<b>6.000</b>	<b>DVE40M438</b>
2.500	2.218	DVE10M141	3.875	3.125	DVE40M416	7.000	6.625	DVE20M261
<b>2.500</b>	<b>2.125</b>	<b>DVE20M228</b>	4.000	3.625	DVE20M240	<b>7.000</b>	<b>6.250</b>	<b>DVE40M439</b>
2.500	1.938	DVE30M330	<b>4.000</b>	<b>3.438</b>	<b>DVE30M342</b>	7.250	6.875	DVE20M262
2.500	1.750	DVE40M405	4.000	3.250	DVE40M417	<b>7.250</b>	<b>6.500</b>	<b>DVE40M440</b>
2.625	2.438	DVE00M037	4.125	3.938	DVE00M045	7.500	7.125	DVE20M263
2.625	2.343	DVE10M143	4.125	3.750	DVE20M241	<b>7.500</b>	<b>6.750</b>	<b>DVE40M441</b>
<b>2.625</b>	<b>2.250</b>	<b>DVE20M229</b>	<b>4.125</b>	<b>3.563</b>	<b>DVE30M343</b>	7.750	7.375	DVE20M264
2.625	2.063	DVE30M331	4.125	3.375	DVE40M418	<b>7.750</b>	<b>7.000</b>	<b>DVE40M442</b>
2.625	1.875	DVE40M406	4.250	3.875	DVE20M242	8.000	7.625	DVE20M265
2.750	2.563	DVE00M038	4.250	3.688	DVE30M344	<b>8.000</b>	<b>7.250</b>	<b>DVE40M443</b>
2.750	2.468	DVE10M145	4.250	3.500	DVE40M419	8.250	7.875	DVE20M266
<b>2.750</b>	<b>2.375</b>	<b>DVE20M230</b>	4.375	4.000	DVE20M243	<b>8.250</b>	<b>7.500</b>	<b>DVE40M444</b>
2.750	2.188	DVE30M332	<b>4.375</b>	<b>3.813</b>	<b>DVE30M345</b>	8.500	8.125	DVE20M267
2.750	2.000	DVE40M407	4.375	3.625	DVE40M420	8.500	7.750	DVE40M445
2.875	2.688	DVE00M039	4.500	4.125	DVE20M244	9.000	8.625	DVE20M269
2.875	2.593	DVE10M147	<b>4.500</b>	<b>3.938</b>	<b>DVE30M346</b>	<b>9.000</b>	<b>8.250</b>	<b>DVE40M446</b>
<b>2.875</b>	<b>2.500</b>	<b>DVE20M231</b>	4.500	3.750	DVE40M421	<b>9.500</b>	<b>8.750</b>	<b>DVE40M447</b>
2.875	2.313	DVE30M333	4.625	4.250	DVE20M245	<b>10.000</b>	<b>9.250</b>	<b>DVE40M448</b>
2.875	2.125	DVE40M408	<b>4.625</b>	<b>4.063</b>	<b>DVE30M347</b>	<b>10.500</b>	<b>9.750</b>	<b>DVE40M449</b>
3.000	2.813	DVE00M040	4.625	3.875	DVE40M422	<b>11.000</b>	<b>10.250</b>	<b>DVE40M450</b>
3.000	2.718	DVE10M149	4.750	4.375	DVE20M246	<b>11.500</b>	<b>10.750</b>	<b>DVE40M451</b>
<b>3.000</b>	<b>2.625</b>	<b>DVE20M232</b>	<b>4.750</b>	<b>4.188</b>	<b>DVE30M348</b>	<b>12.000</b>	<b>11.250</b>	<b>DVE40M452</b>
3.000	2.438	DVE30M334	4.750	4.000	DVE40M423	<b>12.500</b>	<b>11.750</b>	<b>DVE40M453</b>
3.000	2.250	DVE40M409	4.875	4.500	DVE20M247	<b>13.000</b>	<b>12.250</b>	<b>DVE40M454</b>
3.125	2.938	DVE00M041	<b>4.875</b>	<b>4.313</b>	<b>DVE30M349</b>	<b>13.500</b>	<b>12.750</b>	<b>DVE40M455</b>
<b>3.125</b>	<b>2.750</b>	<b>DVE20M233</b>	4.875	4.125	DVE40M424	<b>14.000</b>	<b>13.250</b>	<b>DVE40M456</b>
3.125	2.563	DVE30M335	5.000	4.625	DVE20M248	<b>14.500</b>	<b>13.750</b>	<b>DVE40M457</b>
3.125	2.375	DVE40M410	<b>5.000</b>	<b>4.438</b>	<b>DVE30M350</b>	<b>15.000</b>	<b>14.250</b>	<b>DVE40M458</b>
<b>3.250</b>	<b>2.875</b>	<b>DVE20M234</b>	5.000	4.250	DVE40M425	<b>15.500</b>	<b>14.750</b>	<b>DVE40M459</b>
3.250	2.688	DVE30M336	5.250	4.875	DVE20M250	<b>16.000</b>	<b>15.250</b>	<b>DVE40M460</b>
3.250	2.500	DVE40M411	<b>5.250</b>	<b>4.688</b>	<b>DVE30M352</b>			
3.375	3.188	DVE00M042	5.250	4.500	DVE40M427			
<b>3.375</b>	<b>3.000</b>	<b>DVE20M235</b>	5.500	5.125	DVE20M252			
3.375	2.813	DVE30M337	5.500	4.938	DVE30M354			
3.375	2.625	DVE40M412	5.500	4.750	DVE40M429			
<b>3.500</b>	<b>3.125</b>	<b>DVE20M236</b>	5.750	5.375	DVE20M254			
3.500	2.938	DVE30M338	5.750	5.188	DVE30M356			
3.500	2.750	DVE40M413	<b>5.750</b>	<b>5.000</b>	<b>DVE40M431</b>			

Figures in **bold** are preferred sizes.  
For additional size and part number details please contact your local Trelleborg Sealing Solutions Marketing company.



---

! This page is intentionally left blank.



## ■ Installation Recommendations for External Face Seals – Type HF – Metric

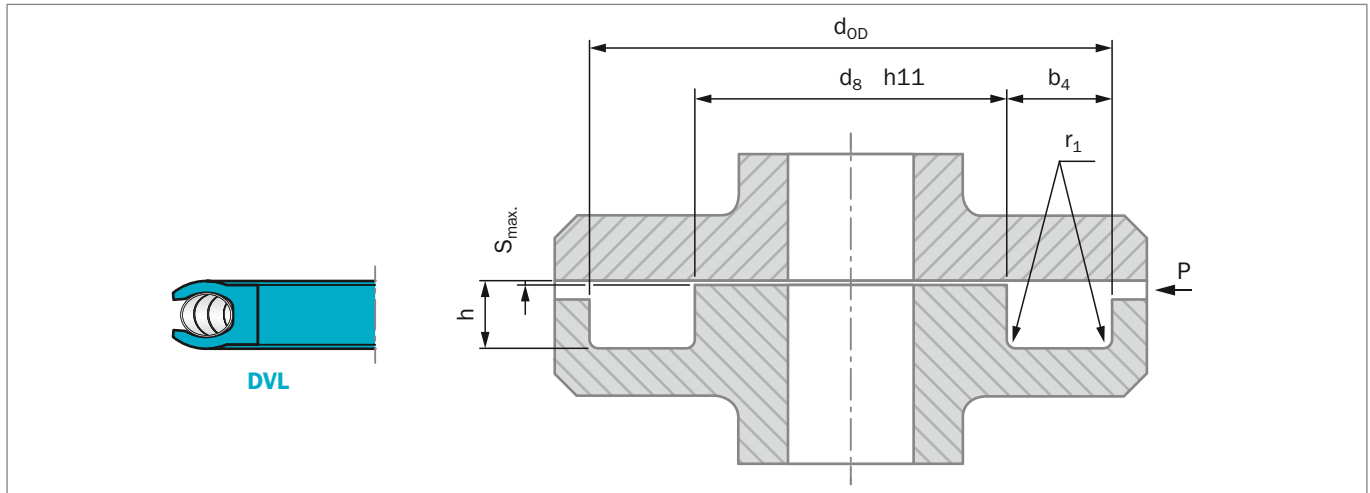

Figure 27: Installation Drawing

**Table 36: Installation Dimensions – Metric**

Series Number	Groove Inside Diameter $d_g$ h11		h		$b_4$ Groove Width Min	$r_1$ Radius Max	Axial Clearance $S_{max}$			
	Standard Range	Extended Range <sup>1)</sup>	Groove Depth				2 MPa	10 MPa	20 MPa	40 MPa
DVL0	3.0 - 9.9	3.0 - 40.0	1.45	+0.03	2.40	0.25	0.20	0.10	0.08	0.05
DVL1	10.0 - 19.9	8.0 - 200.0	2.25	+0.05	3.60	0.38	0.25	0.15	0.10	0.07
DVL2	20.0 - 39.9	12.0 - 400.0	3.10	+0.08	4.80	0.38	0.35	0.20	0.15	0.08
DVL3	40.0 - 119.9	20.0 - 700.0*	4.70	+0.10	7.10*	0.38	0.50	0.25	0.20	0.10
DVL4	120.0 - 999.9**	35.0 - 1600.0**	6.10	+0.15	9.50**	0.51	0.60	0.30	0.25	0.12
DVL5	1000.0 - 2500.9***	80.0 - 2500.0***	9.50	+0.20	15.00***	0.51	0.90	0.50	0.40	0.20

\* For diameters above 700 mm  $b_4$  min. = 8.0 mm

\*\* For diameters above 700 mm  $b_4$  min. = 11.0 mm

\*\*\* For diameters above 1000 mm  $b_4$  min. = 18.0 mm

1) Available on request

h11 tolerance can be found using the ISO Fits & Tolerance App, see page 88.

**Table 37: Size Series – Metric**

$d_g$	$d_{OD}$ Min	TSS Part No.	$d_g$	$d_{OD}$ Min	TSS Part No.	$d_g$	$d_{OD}$ Min	TSS Part No.
4.0	8.8	DVL000040	35.0	44.6	DVL200350	85.0	99.2	DVL300850
5.0	9.8	DVL000050	36.0	45.6	DVL200360	90.0	104.2	DVL300900
6.0	10.8	DVL000060	40.0	54.2	DVL300400	95.0	109.2	DVL300950
8.0	12.8	DVL000080	42.0	56.2	DVL300420	100.0	114.2	DVL301000
10.0	17.2	DVL100100	45.0	59.2	DVL300450	105.0	119.2	DVL301050
12.0	19.2	DVL100120	48.0	62.2	DVL300480	110.0	124.2	DVL301100
14.0	21.2	DVL100140	50.0	64.2	DVL300500	115.0	129.2	DVL301150
15.0	22.2	DVL100150	52.0	66.2	DVL300520	120.0	139.0	DVL401200
16.0	23.2	DVL100160	55.0	69.2	DVL300550	125.0	144.0	DVL401250
18.0	25.2	DVL100180	56.0	70.2	DVL300560	130.0	149.0	DVL401300
20.0	29.6	DVL200200	60.0	74.2	DVL300600	135.0	154.0	DVL401350
22.0	31.6	DVL200220	63.0	77.2	DVL300630	140.0	159.0	DVL401400
25.0	34.6	DVL200250	65.0	79.2	DVL300650	150.0	169.0	DVL401500
28.0	37.6	DVL200280	70.0	84.2	DVL300700	160.0	179.0	DVL401600
30.0	39.6	DVL200300	75.0	89.2	DVL300750	170.0	189.0	DVL401700
32.0	41.6	DVL200320	80.0	94.2	DVL300800	180.0	199.00	DVL401800

For additional size and part number details please contact your local Trelleborg Sealing Solutions Marketing company.



**Table 38: Part Number System for External Face Seals – Metric**

Article Code	Cross-Section	Size	Class	Seal Material	Spring Material	Spring Load
<b>DVL</b> Variseal HF (External)	<b>0</b> 1.45	<b>0xxxx</b> Groove ID <1000 (dia x 10.0)	- Industrial	<b>T01</b>	<b>S</b> Stainless Steel	<b>Standard load for each design</b>
	<b>1</b> 2.25	<b>Xxxxx</b> Groove ID >= 1000 (dia x 1.0)	<b>A</b> Aerospace	<b>MF1</b>	<b>H</b> Hastelloy	
	<b>2</b> 3.10			<b>MF4</b>	<b>E</b> Elgiloy	
	<b>3</b> 4.70			<b>MF6</b>		
	<b>4</b> 6.10			<b>T05</b>		
	<b>5</b> 9.50			<b>T07</b>		
				<b>T24</b> See page 7 for material description		
				<b>T40</b>		
				<b>M79</b>		<b>H</b> Heavy
				<b>Z48</b>		
				<b>Z80</b>		

**ORDERING EXAMPLE 1**

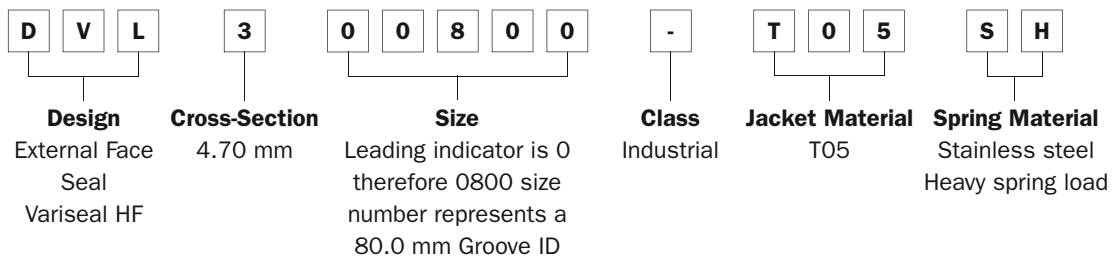

**ORDERING EXAMPLE 2**

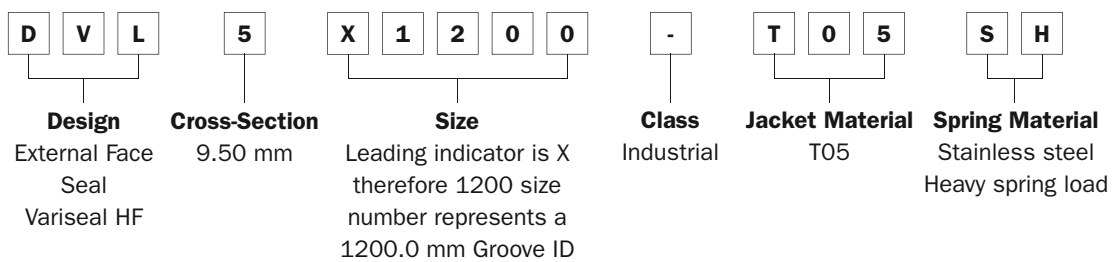



## ■ Installation Recommendations for External Face Seals – Type HF – Inch

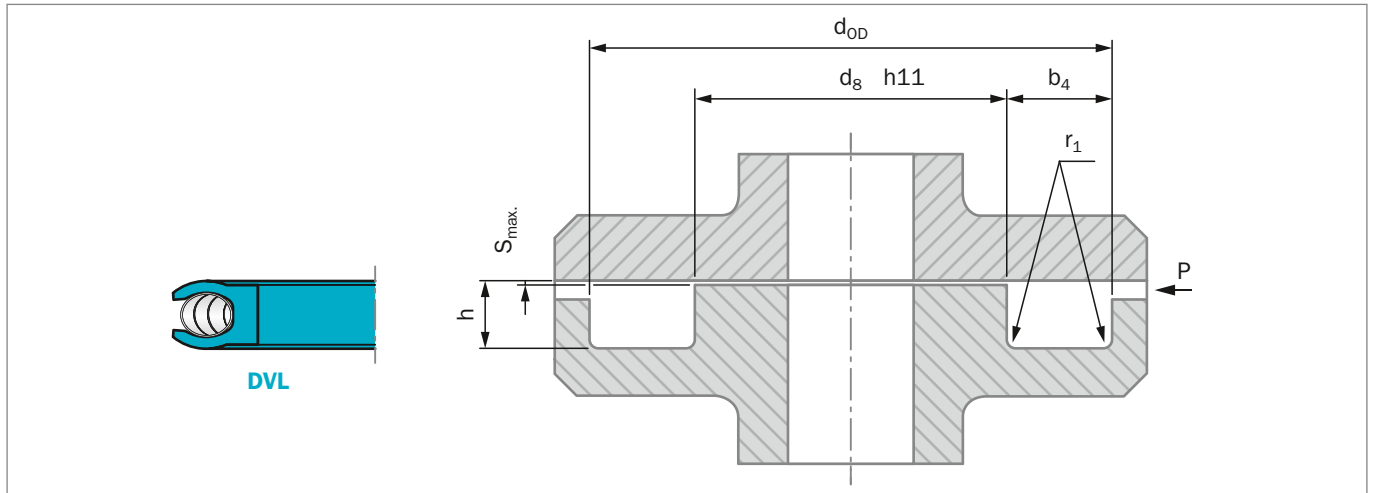

Figure 28: Installation Drawing

Table 39: Installation Dimensions – Inch

Series Number	h		b <sub>4</sub> Groove Width	r <sub>1</sub> Radius	Axial Clearance S <sub>max</sub>			
	Groove Depth				290 psi	1,450 psi	2,900 psi	5,800 psi
	Min	Max						
DVLO	0.057	+ 0.002	0.094	0.010	0.008	0.004	0.003	0.002
DVL1	0.089	+ 0.002	0.141	0.015	0.010	0.006	0.004	0.003
DVL2	0.122	+ 0.002	0.188	0.015	0.014	0.008	0.006	0.003
DVL3	0.186	+ 0.002	0.281	0.015	0.020	0.010	0.008	0.004
DVL4	0.238	+ 0.002	0.375	0.020	0.024	0.012	0.010	0.005
DVL5	0.374	+ 0.004	0.591	0.020	0.030	0.015	0.012	0.008

h11 tolerance can be found using the ISO Fits & Tolerance App, see page 88.

Table 40: Standard Dash Sizes – Inch

d <sub>g</sub>	d <sub>OD</sub> Min	TSS Part No.	d <sub>g</sub>	d <sub>OD</sub> Min	TSS Part No.	d <sub>g</sub>	d <sub>OD</sub> Min	TSS Part No.
<b>0.125</b>	<b>0.312</b>	<b>DVL00M006</b>	<b>0.875</b>	<b>1.157</b>	<b>DVL10M118</b>	1.250	1.812	DVL30M322
<b>0.187</b>	<b>0.375</b>	<b>DVL00M008</b>	0.875	1.250	DVL20M212	1.375	1.562	DVL00M028
<b>0.250</b>	<b>0.437</b>	<b>DVL00M010</b>	0.875	1.437	DVL30M316	1.375	1.657	DVL10M126
0.375	0.562	DVL00M012	1.000	1.187	DVL00M022	<b>1.375</b>	<b>1.750</b>	<b>DVL20M220</b>
<b>0.375</b>	<b>0.657</b>	<b>DVL10M110</b>	1.000	1.282	DVL10M120	1.375	1.937	DVL30M324
0.500	0.687	DVL00M014	<b>1.000</b>	<b>1.375</b>	<b>DVL20M214</b>	1.500	1.687	DVL00M029
<b>0.500</b>	<b>0.782</b>	<b>DVL10M112</b>	1.000	1.562	DVL30M318	1.500	1.782	DVL10M128
0.625	0.812	DVL00M016	1.125	1.312	DVL00M024	<b>1.500</b>	<b>1.875</b>	<b>DVL20M222</b>
<b>0.625</b>	<b>0.907</b>	<b>DVL10M114</b>	1.125	1.407	DVL10M122	1.500	2.062	DVL30M325
0.625	1.000	DVL20M208	<b>1.125</b>	<b>1.500</b>	<b>DVL20M216</b>	1.500	2.250	DVL40M401
0.750	0.937	DVL00M018	1.125	1.687	DVL30M320	1.625	1.812	DVL00M030
<b>0.750</b>	<b>1.032</b>	<b>DVL10M116</b>	1.250	1.437	DVL00M026	1.625	1.907	DVL10M130
0.750	1.125	DVL20M210	1.250	1.532	DVL10M124	<b>1.625</b>	<b>2.000</b>	<b>DVL20M223</b>
0.875	1.062	DVL00M020	<b>1.250</b>	<b>1.625</b>	<b>DVL20M218</b>	1.625	2.187	DVL30M326





d <sub>g</sub>	d <sub>OD</sub> Min	TSS Part No.	d <sub>g</sub>	d <sub>OD</sub> Min	TSS Part No.	d <sub>g</sub>	d <sub>OD</sub> Min	TSS Part No.
1.625	2.375	DVL40M402	2.750	3.312	DVL30M335	4.250	4.532	DVL10M156
1.750	1.937	DVL00M031	2.750	3.500	DVL40M411	4.250	4.625	DVL20M244
1.750	2.032	DVL10M132	2.875	3.062	DVL00M040	<b>4.250</b>	<b>4.812</b>	<b>DVL30M347</b>
<b>1.750</b>	<b>2.125</b>	<b>DVL20M224</b>	2.875	3.157	DVL10M150	4.250	5.000	DVL40M423
1.750	2.312	DVL30M327	<b>2.875</b>	<b>3.250</b>	<b>DVL20M233</b>	4.500	4.782	DVL10M157
1.750	2.500	DVL40M403	2.875	3.437	DVL30M336	4.500	4.875	DVL20M246
1.875	2.062	DVL00M032	2.875	3.625	DVL40M412	<b>4.500</b>	<b>5.062</b>	<b>DVL30M349</b>
1.875	2.157	DVL10M134	3.000	3.187	DVL00M041	4.500	5.250	DVL40M425
<b>1.875</b>	<b>2.250</b>	<b>DVL20M225</b>	3.000	3.282	DVL10M151	4.750	5.032	DVL10M158
1.875	2.437	DVL30M328	<b>3.000</b>	<b>3.375</b>	<b>DVL20M234</b>	4.750	5.125	DVL20M248
1.875	2.625	DVL40M404	3.000	3.562	DVL30M337	<b>4.750</b>	<b>5.312</b>	<b>DVL30M351</b>
2.000	2.187	DVL00M033	3.000	3.750	DVL40M413	4.750	5.500	DVL40M427
2.000	2.282	DVL10M136	<b>3.125</b>	<b>3.500</b>	<b>DVL20M235</b>	5.000	5.282	DVL10M159
<b>2.000</b>	<b>2.375</b>	<b>DVL20M226</b>	3.125	3.687	DVL30M338	5.000	5.375	DVL20M250
2.000	2.562	DVL30M329	3.125	3.875	DVL40M414	<b>5.000</b>	<b>5.562</b>	<b>DVL30M353</b>
2.000	2.750	DVL40M405	3.250	3.437	DVL00M042	5.000	5.750	DVL40M429
2.125	2.312	DVL00M034	3.250	3.532	DVL10M152	5.250	5.532	DVL10M160
2.125	2.407	DVL10M138	<b>3.250</b>	<b>3.625</b>	<b>DVL20M236</b>	5.250	5.625	DVL20M252
<b>2.125</b>	<b>2.500</b>	<b>DVL20M227</b>	3.250	3.812	DVL30M339	5.250	5.812	DVL30M355
2.125	2.687	DVL30M330	3.250	4.000	DVL40M415	<b>5.250</b>	<b>6.000</b>	<b>DVL40M431</b>
2.125	2.875	DVL40M406	3.375	3.750	DVL20M237	5.500	5.782	DVL10M161
2.250	2.437	DVL00M035	<b>3.375</b>	<b>3.937</b>	<b>DVL30M340</b>	5.500	5.875	DVL20M254
2.250	2.532	DVL10M140	3.375	4.125	DVL40M416	5.500	6.062	DVL30M357
<b>2.250</b>	<b>2.625</b>	<b>DVL20M228</b>	3.500	3.687	DVL00M043	<b>5.500</b>	<b>6.250</b>	<b>DVL40M433</b>
2.250	2.812	DVL30M331	3.500	3.782	DVL10M153	5.750	6.125	DVL20M256
2.250	3.000	DVL40M407	3.500	3.875	DVL20M238	5.750	6.312	DVL30M359
2.375	2.562	DVL00M036	<b>3.500</b>	<b>4.062</b>	<b>DVL30M341</b>	<b>5.750</b>	<b>6.500</b>	<b>DVL40M435</b>
2.375	2.657	DVL10M142	3.500	4.250	DVL40M417	6.000	6.375	DVL20M258
<b>2.375</b>	<b>2.750</b>	<b>DVL20M229</b>	3.625	4.000	DVL20M239	6.000	6.562	DVL30M361
2.375	2.937	DVL30M332	<b>3.625</b>	<b>4.187</b>	<b>DVL30M342</b>	<b>6.000</b>	<b>6.750</b>	<b>DVL40M437</b>
2.375	3.125	DVL40M408	3.625	4.375	DVL40M418	6.250	6.625	DVL20M259
2.500	2.687	DVL00M037	3.750	3.937	DVL00M044	6.250	6.812	DVL30M362
2.500	2.782	DVL10M144	3.750	4.032	DVL10M154	<b>6.250</b>	<b>7.000</b>	<b>DVL40M438</b>
<b>2.500</b>	<b>2.875</b>	<b>DVL20M230</b>	3.750	4.125	DVL20M240	6.500	6.875	DVL20M260
2.500	3.062	DVL30M333	<b>3.750</b>	<b>4.312</b>	<b>DVL30M343</b>	6.500	7.062	DVL30M363
2.500	3.250	DVL40M409	3.750	4.500	DVL40M419	<b>6.500</b>	<b>7.250</b>	<b>DVL40M439</b>
2.625	2.812	DVL00M038	3.875	4.250	DVL20M241	6.750	7.125	DVL20M261
2.625	2.907	DVL10M146	<b>3.875</b>	<b>4.437</b>	<b>DVL30M344</b>	6.750	7.312	DVL30M364
<b>2.625</b>	<b>3.000</b>	<b>DVL20M231</b>	3.875	4.625	DVL40M420	<b>6.750</b>	<b>7.500</b>	<b>DVL40M440</b>
2.625	3.187	DVL30M334	4.000	4.187	DVL00M045	7.000	7.375	DVL20M262
2.625	3.375	DVL40M410	4.000	4.282	DVL10M155	7.000	7.562	DVL30M365
2.750	2.937	DVL00M039	4.000	4.375	DVL20M242	<b>7.000</b>	<b>7.750</b>	<b>DVL40M441</b>
2.750	3.032	DVL10M148	<b>4.000</b>	<b>4.562</b>	<b>DVL30M345</b>	7.500	7.875	DVL20M264
<b>2.750</b>	<b>3.125</b>	<b>DVL20M232</b>	4.000	4.750	DVL40M421	7.500	8.062	DVL30M367



<b>d<sub>g</sub></b>	<b>d<sub>OD Min</sub></b>	<b>TSS Part No.</b>	<b>d<sub>g</sub></b>	<b>d<sub>OD Min</sub></b>	<b>TSS Part No.</b>
<b>7.500</b>	<b>8.250</b>	<b>DVL40M443</b>	10.000	10.562	DVL30M377
8.000	8.375	DVL20M266	<b>10.000</b>	<b>10.750</b>	<b>DVL40M449</b>
8.000	8.562	DVL30M369	<b>11.000</b>	<b>11.750</b>	<b>DVL40M451</b>
<b>8.000</b>	<b>8.750</b>	<b>DVL40M445</b>	<b>12.000</b>	<b>12.750</b>	<b>DVL40M453</b>
9.000	9.375	DVL20M270	<b>13.000</b>	<b>13.750</b>	<b>DVL40M455</b>
9.000	9.562	DVL30M373	<b>14.000</b>	<b>14.750</b>	<b>DVL40M457</b>
<b>9.000</b>	<b>9.750</b>	<b>DVL40M447</b>	<b>15.000</b>	<b>15.750</b>	<b>DVL40M459</b>

Figures in **bold** are preferred sizes.  
For additional size and part number details please contact your local Trelleborg Sealing Solutions Marketing company.



**Table 41: Part Number System for External Face Seals – Inch**

Article Code	Cross-Section	Size	Class	Seal Material	Spring Material	Spring Load
<b>DVL</b> Variseal HF (External)	<b>0</b> 0.056 <b>1</b> 0.089 <b>2</b> 0.122 <b>3</b> 0.186 <b>4</b> 0.239 <b>5</b> 0.375	<b>OMxxx</b> Dash # <b>Sxxxx</b> Groove ID < 10.0 Inch (dia x 1000.0) <b>Lxxxx</b> Groove ID >= 10.0 (dia x 100.0)	- Industrial <b>A</b> Aerospace	<b>T01</b> <b>MF1</b> <b>MF4</b> <b>MF6</b> <b>T05</b> <b>T07</b> See page 7 <b>T12</b> for material <b>T24</b> description <b>T40</b> <b>M79</b> <b>Z48</b> <b>Z80</b>	<b>S</b> Stainless Steel <b>H</b> Hastelloy <b>E</b> Elgiloy	<b>Standard load for each design</b>  <b>H</b> Heavy

**ORDERING EXAMPLE 1**

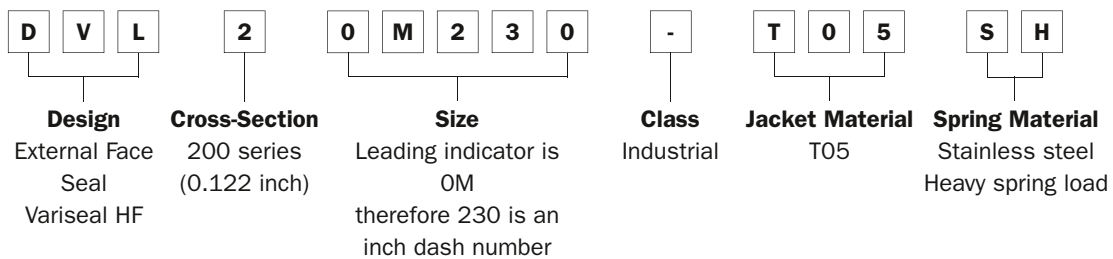

**ORDERING EXAMPLE 2**

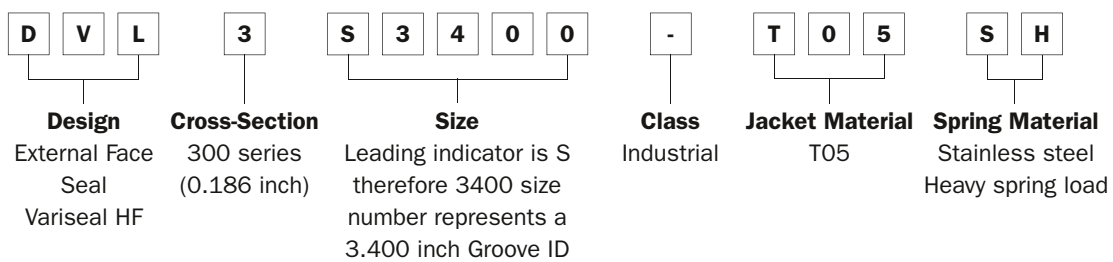



## Turcon® Roto Variseal®

### DESCRIPTION

Turcon® Roto Variseal® is excellent in rotary, reciprocating and static applications, when there is a need to lock the seal in the groove.

The standard Variseal® for rotary applications, Turcon® Roto Variseal® is a single acting seal consisting of a U-shaped jacket and a V-shaped corrosion resistant spring.

Turcon® Roto Variseal® has a flanged heel, which prevents the seal from rotating in the groove and a short heavy dynamic lip that reduces friction. This gives a long service life and good scraping ability, even in media of high viscosity.

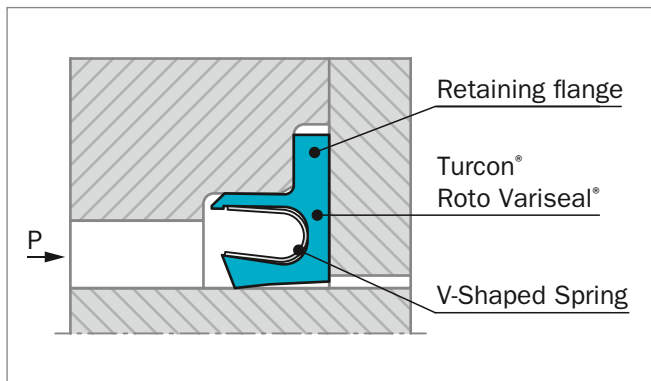

Figure 29: Turcon® Roto Variseal®

### AREAS OF APPLICATION

- Rotary shafts on general hydraulic applications
- Plastic injection molding machines
- Rotating and pivoting arms
- Gearbox shafts

### TECHNICAL DATA

<b>Operating Pressure:</b>	Maximum dynamic load: 20 MPa / 2,900 psi Maximum static load: 25 MPa / 3,626 psi
<b>Speed:</b>	Reciprocating up to 10 m/s / 1,980 fpm, Rotating up to 2 m/s / 390 fpm
<b>Temperature:</b>	-70 °C to +300 °C / -94 °F to +572 °F
<b>Media compatibility:</b>	Virtually all fluids, chemicals and gases

### IMPORTANT NOTE

The above data are maximum values and cannot be used at the same time, e. g. the maximum operating speed depends on material type, pressure, temperature and gap value. Temperature range also depends on the media.



### FRICTIONAL FORCE

Indicative values for frictional force are included in figure below. Frictional force is given as a function of sliding speed and operating pressure for a shaft diameter of 2 inch / 50 mm at an oil temperature of +140 °F / +60 °C. The operating limits are lower at higher temperatures.

Indicative values for other shaft diameters can be calculated from the formula:

$$P \cong P_{50} \times \left( \frac{d}{50 \text{ mm}} \right) \text{ [W]}$$

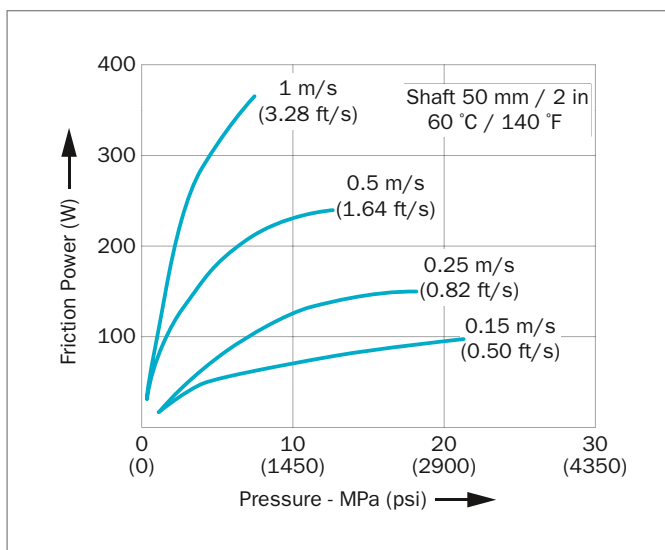

Figure 30: Frictional Force for Turcon® Roto Variseal®

The indicative values apply for constant operating conditions. Changes in these, such as pressure fluctuations or direction of rotation, can result in significantly higher frictional values.

### APPLICATION LIMITS

The maximum operating limits for temperature, pressure and speed are dependent upon one another and therefore cannot all apply at the same time.

The lubrication properties of the media to be sealed and heat dissipation must also be taken into consideration.

The following PV values can be used as general guidelines:

- Poor lubrication up to PV = 2 MPa x m/s (950 psi x ft/s)
- Good lubrication up to PV = 5 MPa x m/s (2375 psi x ft/s)
- Very good cooling up to PV = 8 MPa x m/s (3800 psi x ft/s)

These values are lower for diameters < 50 mm / 2 inches. Tests of these characteristics are recommended to establish application limits.

### MATING SURFACE MATERIALS

Sealing of applications with rotating movements require very good mating surfaces. A minimum hardness 55 HRC is recommended to a hardening depth of at least 0.3 mm / 0.01 inch.

Particular attention must be paid to coated surfaces and good heat dissipation through the coating is required.

**Table 42: Permissible Eccentricity for Turcon® Roto Variseal®**

TSS Series No.	Max. allowable deviation mm	Max. allowable deviation inch
TVM1	0.05	0.002
TVM2	0.10	0.004
TVM3	0.15	0.006
TVM4	0.20	0.008



## ■ Installation Recommendations for Roto Variseal® – Type TVM – Metric

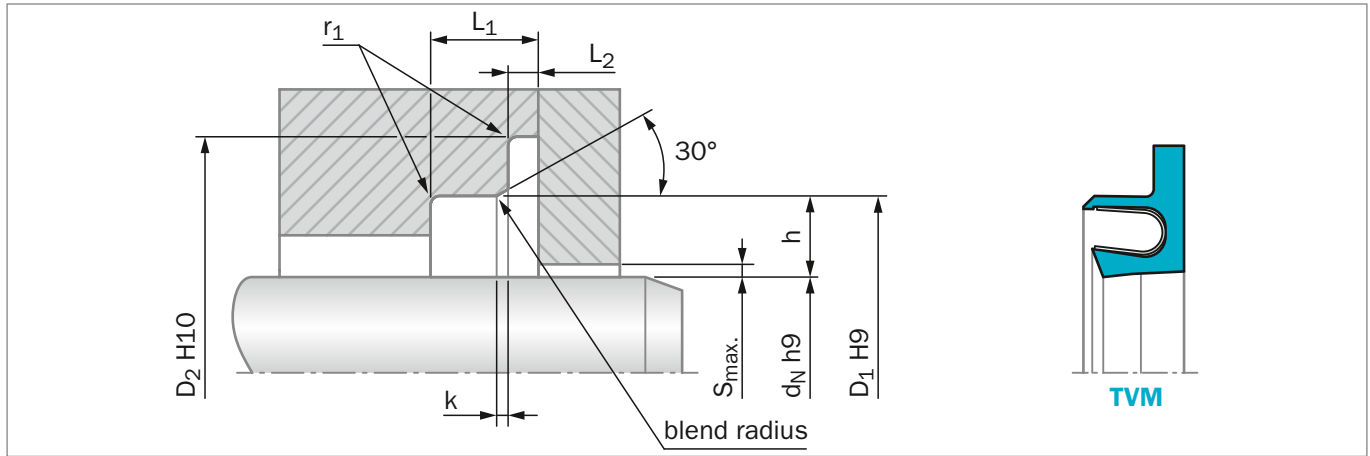

Figure 31: Installation Drawing

**Table 43: Installation Dimensions – Metric**

Series No.	Shaft Diameter d <sub>N</sub> h9		D <sub>1</sub>	h	D <sub>2</sub>	L <sub>1</sub>	L <sub>2</sub>	k	r <sub>1</sub>	Radial Clearance S <sub>max</sub>			
	Standard Range	Extended Range	Groove Diameter H9	Groove Depth	Flange Diameter H10	Groove Width Min	Flange Groove Width	Lead-in Chamfer	Radius Max	2 MPa	10 MPa	20 MPa	
TVM1	5.0 - 19.9	5.0 - 200.0	d <sub>N</sub> + 5.0	2.50	d <sub>N</sub> + 9.0	3.6	0.85	+0/-0.10	0.8	0.38	0.25	0.15	0.10
TVM2	20.0 - 39.9	10.0 - 400.0	d <sub>N</sub> + 7.0	3.50	d <sub>N</sub> + 12.5	4.8	1.35	+0/-0.15	1.1	0.38	0.35	0.20	0.15
TVM3	40.0 - 399.9	20.0 - 700.0	d <sub>N</sub> + 10.5	5.25	d <sub>N</sub> + 17.5	7.1	1.80	+0/-0.20	1.4	0.38	0.50	0.25	0.20
TVM4	400.0 - 999.9	35.0 - 999.9	d <sub>N</sub> + 14.0	7.00	d <sub>N</sub> + 22.0	9.5	2.80	+0/-0.20	1.6	0.51	0.60	0.30	0.25

h9/H9 tolerance can be found using the ISO Fits & Tolerance App, see page 88.

**Table 44: Size Series – Metric**

d <sub>N</sub>	D <sub>1</sub>	D <sub>2</sub>	TSS Part No.	d <sub>N</sub>	D <sub>1</sub>	D <sub>2</sub>	TSS Part No.	d <sub>N</sub>	D <sub>1</sub>	D <sub>2</sub>	TSS Part No.
5.0	10.0	14.0	TVM100050	42.0	52.5	59.5	TVM300420	110.0	120.5	127.5	TVM301100
6.0	11.0	15.0	TVM100060	45.0	55.5	62.5	TVM300450	115.0	125.5	132.5	TVM301150
8.0	13.0	17.0	TVM100080	48.0	58.5	65.5	TVM300480	120.0	130.5	137.5	TVM301200
10.0	15.0	19.0	TVM100100	50.0	60.5	67.5	TVM300500	125.0	135.5	142.5	TVM301250
12.0	17.0	21.0	TVM100120	52.0	62.5	69.5	TVM300520	130.0	140.5	147.5	TVM301300
14.0	19.0	23.0	TVM100140	55.0	65.5	72.5	TVM300550	135.0	145.5	152.5	TVM301350
15.0	20.0	24.0	TVM100150	56.0	66.5	73.5	TVM300560	140.0	150.5	157.5	TVM301400
16.0	21.0	25.0	TVM100160	60.0	70.5	77.5	TVM300600	150.0	160.5	167.5	TVM301500
18.0	23.0	27.0	TVM100180	63.0	73.5	80.5	TVM300630	160.0	170.5	177.5	TVM301600
20.0	27.0	32.5	TVM200200	65.0	75.5	82.5	TVM300650	170.0	180.5	187.5	TVM301700
22.0	29.0	34.5	TVM200220	70.0	80.5	87.5	TVM300700	180.0	190.5	197.5	TVM301800
25.0	32.0	37.5	TVM200250	75.0	85.5	92.5	TVM300750	190.0	200.5	207.5	TVM301900
28.0	35.0	40.5	TVM200280	80.0	90.5	97.5	TVM300800	200.0	210.5	217.5	TVM302000
30.0	37.0	42.5	TVM200300	85.0	95.5	102.5	TVM300850	210.0	220.5	227.5	TVM302100
32.0	39.0	44.5	TVM200320	90.0	100.5	107.5	TVM300900	220.0	230.5	237.5	TVM302200
35.0	42.0	47.5	TVM200350	95.0	105.5	112.5	TVM300950	230.0	240.5	247.5	TVM302300
36.0	43.0	48.5	TVM200360	100.0	110.5	117.5	TVM301000	240.0	250.5	257.5	TVM302400
40.0	50.5	57.5	TVM300400	105.0	115.5	122.5	TVM301050	250.0	260.5	267.5	TVM302500



**Table 45: Part Number System for Roto Variseal® – Metric**

Article Code	Cross-Section	Size	Class	Seal Material	Spring Material	Spring Load
<b>TVM</b> Roto Variseal	<b>1</b> 2.50	<b>0xxxx</b> Shaft dia. <1000 (dia x 10.0)	- Industrial	<b>T01</b>	<b>S</b> Stainless Steel	<b>Standard load for each design</b>
	<b>2</b> 3.50	<b>Xxxxx</b> Shaft dia. >= 1000 (dia x 1.0)	A Aerospace	<b>MF1</b>	<b>H</b> Hastelloy	
	<b>3</b> 5.25		<b>MF4</b>	<b>E</b> Elgiloy		
	<b>4</b> 7.00		<b>MF6</b>			
	<b>T05</b>					
				<b>T07</b> See page 7		<b>M</b> Medium
				<b>T12</b> for material		<b>R</b> Hi Clean
				<b>T24</b> description		
				<b>T25</b>		
				<b>T40</b>		
				<b>M79</b>		
				<b>Z48</b>		
				<b>Z80</b>		

**ORDERING EXAMPLE 1**

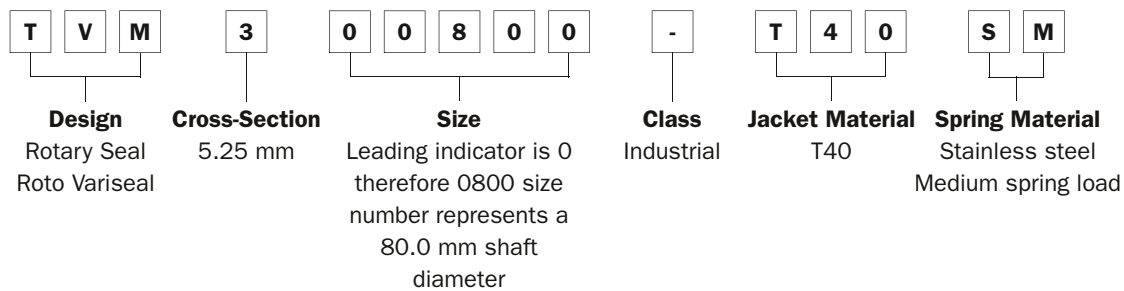

**ORDERING EXAMPLE 2**

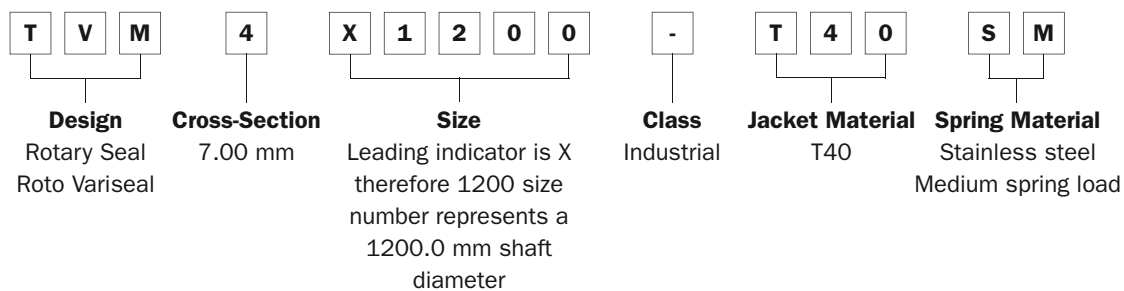



## ■ Installation Recommendations for Roto Variseal® – Type TVM – Inch

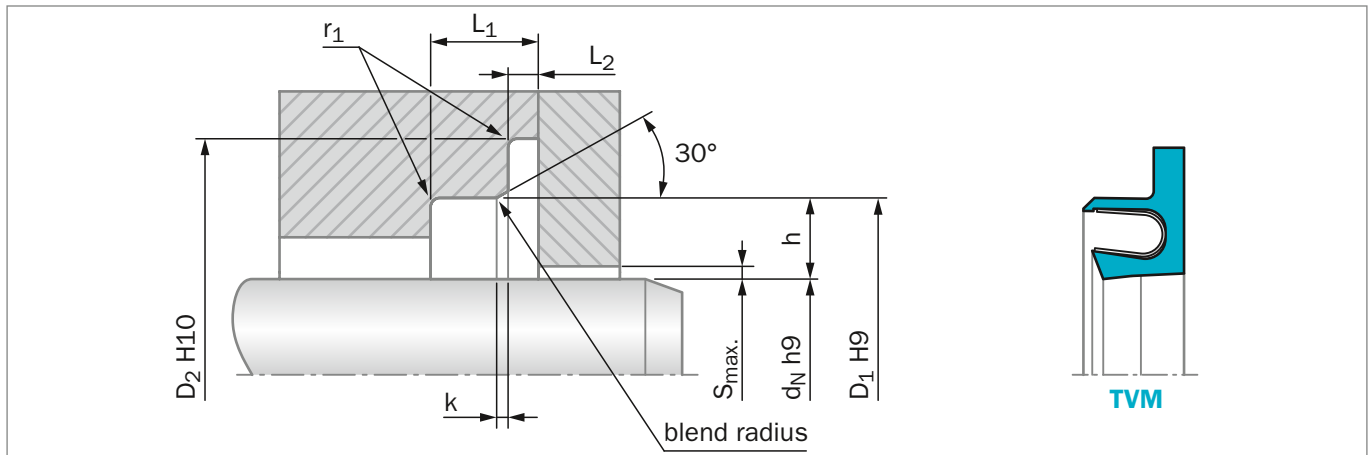

Figure 32: Installation Drawing

**Table 46: Installation Dimensions – Inch**

Series No.	Shaft Diameter d <sub>N</sub> h9		D <sub>1</sub>	D <sub>2</sub>	L <sub>1</sub>	L <sub>2</sub>	k	r <sub>1</sub>	Radial Clearance S <sub>max</sub>			
	Standard Range	Extended Range	Groove Diameter H9	Flange Diameter H10	Groove Width Min	Flange Groove Width	Lead-in Chamfer	Radius Max	2 MPa	10 MPa	20 MPa	
TVM1	0.187 - 0.749	0.187 - 8.000	d <sub>N</sub> + 0.197	d <sub>N</sub> + 0.354	0.141	0.033	+0/-0.004	0.031	0.015	0.010	0.006	0.004
TVM2	0.750 - 1.499	0.375 - 16.000	d <sub>N</sub> + 0.276	d <sub>N</sub> + 0.492	0.189	0.053	+0/-0.006	0.043	0.015	0.014	0.008	0.006
TVM3	1.500 - 14.999	0.750 - 28.000	d <sub>N</sub> + 0.413	d <sub>N</sub> + 0.689	0.280	0.071	+0/-0.008	0.055	0.015	0.020	0.010	0.008
TVM4	15.000 - 39.999	1.500 - 33.999	d <sub>N</sub> + 0.551	d <sub>N</sub> + 0.866	0.374	0.110	+0/-0.008	0.063	0.020	0.024	0.012	0.010

h9/H9 tolerance can be found using the ISO Fits & Tolerance App, see page 88.

**Table 47: Size Series – Inch**

d <sub>N</sub>	D <sub>1</sub>	D <sub>2</sub>	TSS Part No.	d <sub>N</sub>	D <sub>1</sub>	D <sub>2</sub>	TSS Part No.	d <sub>N</sub>	D <sub>1</sub>	D <sub>2</sub>	TSS Part No.
0.187	0.384	0.541	TVM1S0187	1.875	2.288	2.564	TVM3S1875	4.250	4.663	4.939	TVM3S4250
0.250	0.447	0.604	TVM1S0250	2.000	2.413	2.689	TVM3S2000	4.500	4.913	5.189	TVM3S4500
0.312	0.509	0.666	TVM1S0312	2.125	2.538	2.814	TVM3S2125	4.750	5.163	5.439	TVM3S4750
0.375	0.572	0.729	TVM1S0375	2.250	2.663	2.939	TVM3S2250	5.000	5.413	5.689	TVM3S5000
0.437	0.634	0.791	TVM1S0437	2.375	2.788	3.064	TVM3S2375	5.250	5.663	5.939	TVM3S5250
0.500	0.697	0.854	TVM1S0500	2.500	2.913	3.189	TVM3S2500	5.500	5.913	6.189	TVM3S5500
0.562	0.759	0.916	TVM1S0562	2.625	3.038	3.314	TVM3S2625	5.750	6.163	6.439	TVM3S5750
0.625	0.822	0.979	TVM1S0625	2.750	3.163	3.439	TVM3S2750	6.000	6.413	6.689	TVM3S6000
0.687	0.884	1.041	TVM1S0687	2.875	3.288	3.564	TVM3S2875	6.250	6.663	6.939	TVM3S6250
0.750	1.026	1.242	TVM2S0750	3.000	3.413	3.689	TVM3S3000	6.500	6.913	7.189	TVM3S6500
0.875	1.151	1.367	TVM2S0875	3.125	3.538	3.814	TVM3S3125	7.000	7.413	7.689	TVM3S7000
1.000	1.276	1.492	TVM2S1000	3.250	3.663	3.939	TVM3S3250	7.500	7.913	8.189	TVM3S7500
1.125	1.401	1.617	TVM2S1125	3.375	3.788	4.064	TVM3S3375	8.000	8.413	8.689	TVM3S8000
1.250	1.526	1.742	TVM2S1250	3.500	3.913	4.189	TVM3S3500	8.500	8.913	9.189	TVM3S8500
1.375	1.651	1.867	TVM2S1375	3.625	4.038	4.314	TVM3S3625	9.000	9.413	9.689	TVM3S9000
1.500	1.776	1.992	TVM2S1500	3.750	4.163	4.439	TVM3S3750	9.500	9.913	10.189	TVM3S9500
1.625	2.038	2.314	TVM3S1625	3.875	4.288	4.564	TVM3S3875				
1.750	2.163	2.439	TVM3S1750	4.000	4.413	4.689	TVM3S4000				

For additional size and part number details please contact your local Trelleborg Sealing Solutions Marketing company.

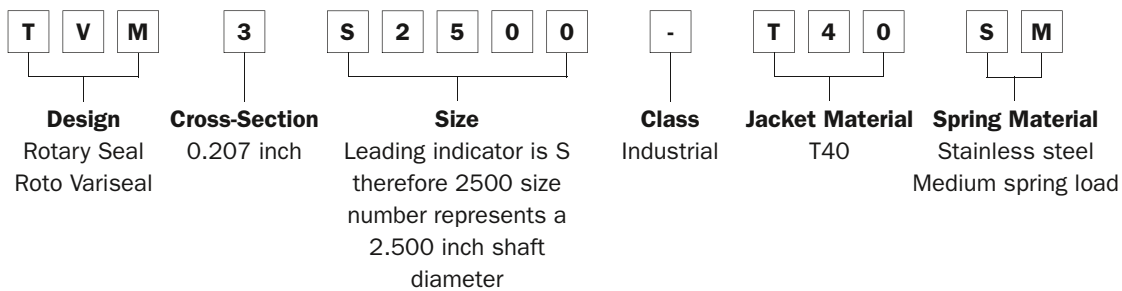



**Table 48: Part Number System for Roto Variseal® – Inch**

Article Code	Cross-Section	Size	Class	Seal Material	Spring Material	Spring Load
<b>TVM</b> Roto Variseal	<b>1</b> 0.098	<b>S</b> xxx Shaft dia. < 10.0 (dia x 1000.0)	- Industrial	<b>T01</b>	<b>S</b> Stainless Steel	<b>Standard load for each design</b>
	<b>2</b> 0.138	<b>L</b> xxx Shaft dia. >= 10.0 (dia x 100.0)	A Aerospace	<b>MF1</b>	<b>H</b> Hastelloy	
	<b>3</b> 0.207		<b>MF4</b>	<b>E</b> Elgiloy		
	<b>4</b> 0.276		<b>MF6</b>			
				<b>T05</b>		<b>M</b> Medium
				<b>T07</b> See page 7		<b>R</b> Hi Clean
				<b>T12</b> for material		
				<b>T24</b> description		
				<b>T25</b>		
				<b>T40</b>		
				<b>M79</b>		
				<b>Z48</b>		
				<b>Z80</b>		

**ORDERING EXAMPLE 1**





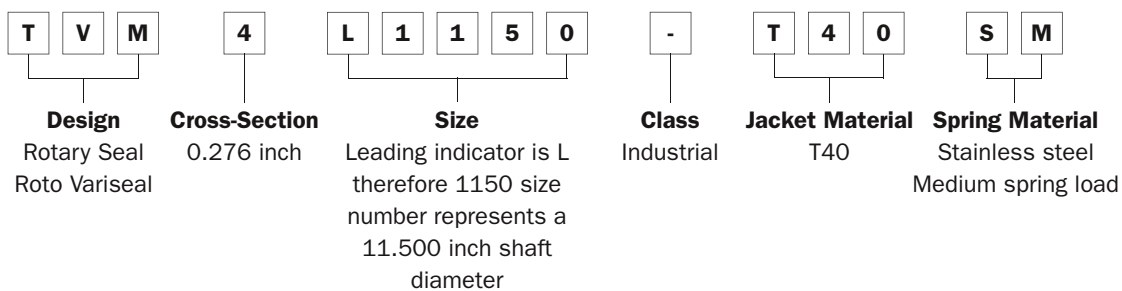







**ORDERING EXAMPLE 2**





**Table 49: Non-Catalog Standard Seal Design**

Seal	Application			Technical Data								Comments			
	Type of Application			Maximum Pressure				Working Temperature		Maximum Speed					
	Type	Static	Reciprocating	Rotary	Dynamic		Static		°C	°F	Recip.		Rotary		
					MPa		MPa				m/s		fpm	m/s	fpm
					Bar	psi	Bar	psi							
W2S 	C	A	C	20		40		-70 to +300	-94 to +572	15	1954	1.27	250	A wiper for those applications that require close control of friction or torque, or with wider hardware tolerance or eccentricities.	
				200	2900	400	5800								
M2 with Ext Heel 	C	A	B	40		52		-70 to +300	-94 to +572	15	1954	1.27	250		For greater extrusion resistance in applications with high pressures and/or temperatures.
				400	5800	520	7500								
W2 with Ext Heel 	C	A	B	40		52		-70 to +300	-94 to +572	15	1954	1.27	250		
				400	5800	520	7500								
MF 	A	-	C	n/a		60		-100 to +200	-148 to +392	n/a	n/a	n/a	For static, slow rotary, or oscillating service sealing between two faces.		
						600	8702								
WF 	A	-	C	n/a		60		-150 to +200	-238 to +392	n/a	n/a	n/a		Same as above except with Slantcoil® use for greater flexibility in small diameters and crosssections.	
						600	8702								
FM 	B	B	A	20		25		-70 to +300	-94 to +572	15	1954	2.00			360
				200	2900	250	3626								
FW 	B	B	A	20		25		-70 to +300	-94 to +572	15	1954	2.00	360		The Slantcoil® spring provides closer control of torque values for low friction applications, and to reduce heat generation in general.
				200	2900	250	3626								
PM 	B	B	A	20		25		-54 to +204	-65 to +400	15	1954	2.00	360	The O-Ring in the seal's O.D. groove acts to prevent rotation with the shaft and to provide a positive static seal on the O.D.	
				200	2900	250	3626								
PW 	B	B	A	20		25		-54 to +204	-65 to +400	15	1954	2.00	360		
				200	2900	250	3626								
CM 	B	B	A	20		25		-70 to +300	-94 to +572	15	1954	2.00	360		A metal encased version of the Variseal PW. The metal provides the most reliable anti-rotation feature of all the rotary seals listed above.
				200	2900	250	3626								
CW 	B	B	A	20		25		-70 to +300	-94 to +572	15	1954	2.00	360	Similar to Variseal CM, this design is energized with a Slantcoil spring which provides lower friction and closer control of torque values.	
				200	2900	250	3626								



## ■ Special Types

### TURCON® VARISEAL® HI-CLEAN

Turcon® Variseal® M2, M2S and Roto Variseal® are available with the spring groove filled with high temperature silicone. Extremely important in food and pharmaceutical processing, this minimizes the trapping of contaminants within the seal, making it easier to clean.

#### ADVANTAGES

- Significantly reduced dead space
- Can be sterilized easily
- Silicone compound increases sealing pressure

When ordering Variseal® Hi-Clean, change the last digit to the letter R.

### TURCON® VARISEAL® WITH EXTENDED HEEL

All Turcon® Variseal® types except the Turcon® Roto Variseal® can be supplied with an extended heel as an alternative to existing O-Ring groove versions, with or without back-up ring (Figure 33 and Figure 35).

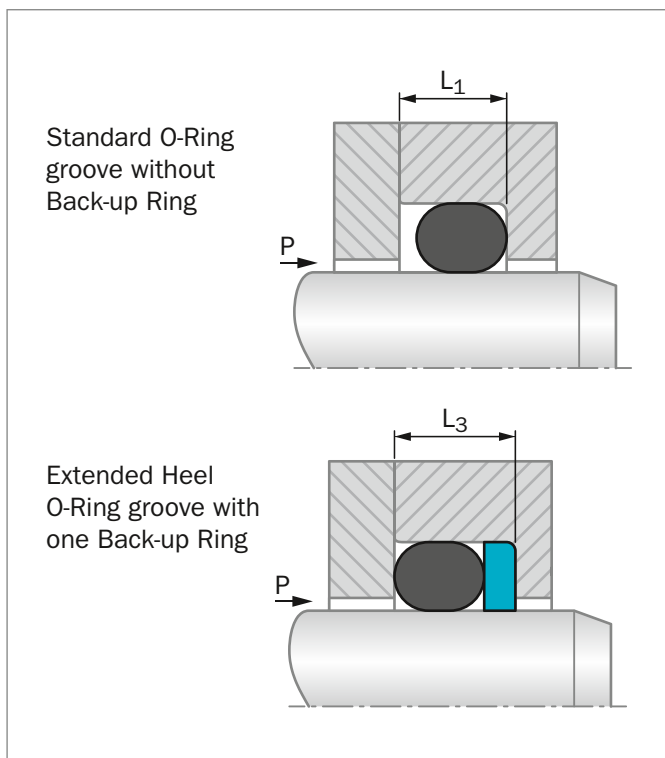

Figure 33: Standard O-Ring groove with and without Back-up Ring

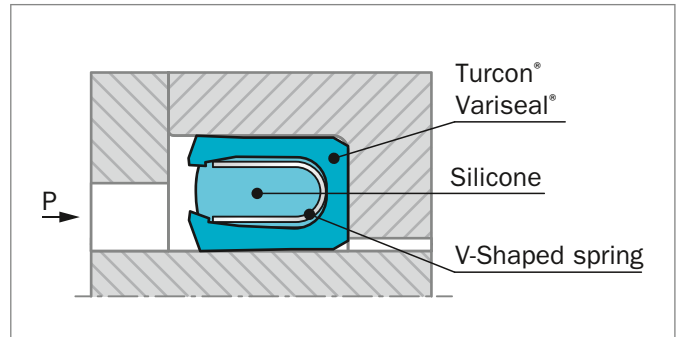

Figure 34: Turcon® Variseal® Hi-Clean

#### ORDERING EXAMPLE

Turcon® Variseal® M2S

<b>Series:</b>	Series RVC2
<b>Type:</b>	N = No Notch, Rod dia <1000
<b>Rod Diameter x 10:</b>	$d_N = 35.0$ mm
<b>Quality Index:</b>	Industrial
<b>Material Code (Seal):</b>	T40
<b>Material Code (Spring):</b>	Stainless Steel
<b>(Spring):</b>	Spring Load; Medium with Hi-Clean (red)

<b>TSS Article No.</b>	<b>RVC2</b>	<b>N</b>	<b>0350</b>	<b>-</b>	<b>T40</b>	<b>S</b>	<b>R</b>
TSS Series No.	_____	_____	_____	_____	_____	_____	_____
Type (Standard)	_____	_____	_____	_____	_____	_____	_____
Rod Diameter x 10	_____	_____	_____	_____	_____	_____	_____
Quality Index (Standard)	_____	_____	_____	_____	_____	_____	_____
Material Code (Seal Ring)	_____	_____	_____	_____	_____	_____	_____
Material Code (Spring)	_____	_____	_____	_____	_____	_____	_____
Spring Load Medium	_____	_____	_____	_____	_____	_____	_____

This version is also recommended for high-pressure applications or when the extrusion gap is larger than prescribed.

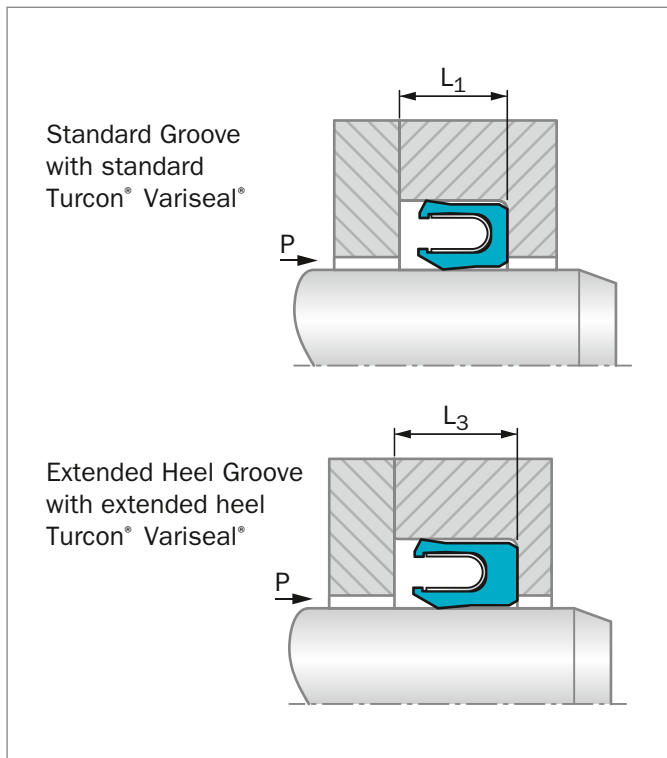

Figure 35: Standard Turcon® Variseal® and Turcon® Variseal® with extended heel

Table 50: Groove Widths

Series No.				Groove Width mm (inch)	
Rod		Piston		L <sub>1</sub>	L <sub>3</sub>
RV_0	RV_A	PV_0	PV_A	2.40 (0.094)	3.80 (0.149)
RV_1	RV_B	PV_1	PV_B	3.60 (0.141)	4.65 (0.183)
RV_2	RV_C	PV_2	PV_C	4.80 (0.188)	5.95 (0.235)
RV_3	RV_D	PV_3	PV_D	7.10 (0.281)	8.50 (0.334)
RV_4	RV_E	PV_4	PV_E	9.50 (0.375)	12.05 (0.475)
RV_5	RV_G	PV_5	PV_G	15.00 (0.591)	20.00 (0.787)

Groove widths for standard grooves L<sub>1</sub> and grooves with one Back-up Ring to L<sub>3</sub>.

A wide range of special and customized Variseal® designs are available. These may be slight modification to standard designs or a completely new configuration if required.

Table 51: Determining the TSS Article Number

Turcon Variseal® Types	Standard Rod/Piston	Extended Heel Rod/Piston
Turcon Variseal® M2	RVA/PVA	RVB/PVB
Turcon Variseal® M2S	RVC/PVC	RVD/PVD
Turcon Variseal® W2	RVJ/PVJ	RVL/PVL
Turcon Variseal® H	RVE/PVE	RVF/PVF

When ordering the above seal types, use the first two letters of the standard TSS Article Number and replace the third letter as shown in table.

ORDERING EXAMPLE

Turcon® Variseal® M2 Extended Heel

<b>Series:</b>	Series RVB2
<b>Type:</b>	N = No Notch, Rod dia <1000
<b>Rod Diameter x 10:</b>	d <sub>N</sub> = 35.0 mm
<b>Quality Index:</b>	Industrial
<b>Material Code (Seal):</b>	T40
<b>Material Code (Spring):</b>	Stainless Steel
<b>(Spring):</b>	Spring Load; Medium

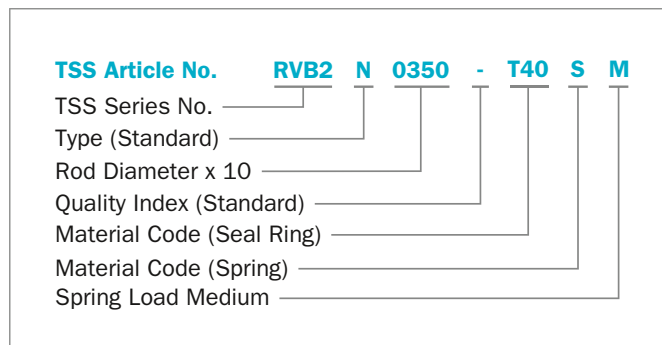

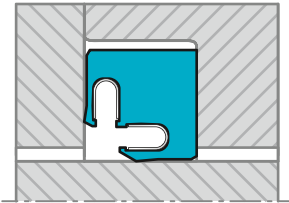

### Rod/Face Seal

Low pressure seal to overcome large eccentricity

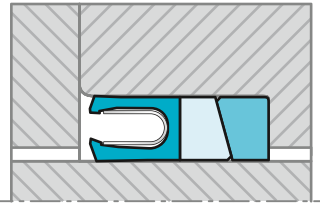

### High Pressure System

Sealing system for extreme high pressure

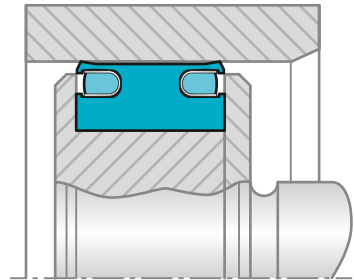

### Double Acting Piston Seal

Hi-Clean version

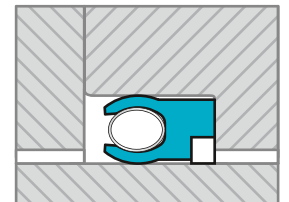

### Turcon® Variseal® with Corner Reinforcement

Variseal® with high modulus corner reinforcement for high temperatures in combination with high pressure or large extrusion gap

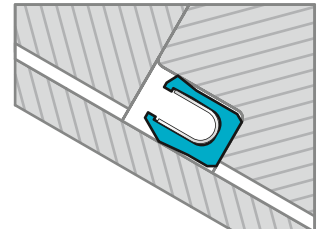

### Conical Seal

Variseal® produced in conical arrangement to seal against angled faces

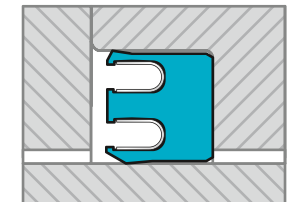

### Double Decker

Can be adopted to most groove dimension

Figure 36: Customized Designs



## ■ General Quality Criteria

The cost-effective use of seals and bearings is highly influenced by the quality criteria applied in production. Seals and bearings from Trelleborg Sealing Solutions are continuously monitored according to strict quality standards from material acquisition through to delivery.

Production facilities are certified according to relevant quality management system standards. Depending on the requirements of the customer or market and in addition to the current ISO 9001, these locations may have further certifications: IATF 16949 for Automotive customers, EN/AS 9100 for Aerospace customers, ISO 13485 for Healthcare & Medical customers and ISO 29001 for Oil & Gas customers. This enables us to provide all market segments with the required quality standards.

Our quality policy is consistently controlled by strict procedures and guidelines which are implemented within all areas of the company.

All testing of materials and products is performed in accordance with accepted test standards and specifications, e.g. random sample testing in accordance with ISO 2859-1 AQL 1.0 general inspection level II, normal inspection.

Inspection specifications correspond to standards applicable to individual product groups (e.g. for O-Rings: ISO 3601).

## ■ Guidelines for the Storage of Polymer Products Based on ISO 2230

Many polymer products and components are stored for long periods of time before being put into service, so it is important they are stored in conditions that minimize unwanted changes in properties. Such changes may result from degradation, in which case they may include excessive hardening, softening, cracking, crazing and other surface effects. Other changes may be caused by deformation, contamination or mechanical damage.

### **Packaging**

Unless otherwise specified in the appropriate product specification, rubber products should be enclosed in individual sealed envelopes. The packaging should be carried out in an atmosphere in which the relative humidity is less than 70%, or if polyurethanes are being packed, less than 65%. Where there is serious risk of ingress of moisture (e.g. rubber-metal-bonded parts), aluminum foil/paper/polyethylene laminate or other similar means of protection should be used to ensure protection from ingress of moisture.

### **Temperature**

The preferred storage temperature for elastomer parts is +15 °C (+59 °F) and should not exceed +25 °C (+77 °F). The products should be stored away from direct sources of heat such as boilers, radiators and direct sunlight. If the storage temperature is below +15 °C (+59 °F), care should be exercised during handling of stored products, as they may have stiffened and have become susceptible to distortion if not handled carefully.

### **Humidity**

The relative humidity should be such that, given in the variations of temperature in storage, condensation does not occur. In all cases, the relative humidity of the atmosphere in storage should be less than 70%, or if polyurethanes are being stored, less than 65%.

### **Light**

Rubber should be protected from light sources, in particular direct sunlight or intense light having a high ultra-violet content. It is advisable that any windows of storage rooms be covered with a red or orange coating or screen.

### **Radiation**

Precautions should be taken to protect stored products from all sources of ionizing radiation likely to cause damage to the products.

### **Ozone**

Ozone has a particularly harmful effect on rubber. Storage rooms should not contain any equipment that is capable of generating ozone, such as mercury vapor lamps or high-voltage electrical equipment giving rise to electric sparks or electrical discharges. Combustion gases and organic vapors should also be excluded, as they may give rise to ozone via photo-chemical processes. When equipment such as a fork-lift truck is used to handle large rubber products, care needs to be taken to ensure this equipment is not a source of pollution that may affect the rubber. Combustion gases should be considered separately. While they are responsible for generating ground-level ozone, they may also contain unburned fuel which, by condensing on rubber products, can cause additional deterioration.

**Deformation**

Rubber should be stored free from tension, compressive stresses or other causes of deformation. Where products are packaged in a strain-free condition, they should be stored in their original packaging. In case of doubt, the manufacturer's advice should be sought. It is advisable that rings of large internal diameter are formed into three equal loops so as to avoid creasing or twisting. It is not possible to achieve this condition by forming just two loops.

**Contact with liquids and semi-liquid materials**

Rubber should not be allowed to come into contact with liquid or semi-liquid materials (for example, petrol, greases, acids, disinfectants, cleaning fluids) or their vapors at any time during storage, unless these materials are by design an integral part of the product or the manufacturer's packaging. When rubber products are received coated with their operational media, they should be stored in this condition.

**Contact with metals**

Certain metals and their alloys (in particular, copper and manganese) are known to have harmful effects on some rubbers. Rubber should not be stored in contact with such metals except when bonded to them. They should be protected by wrapping in, or by separation with, a suitable material, e.g. paper or polyethylene.

**Contact with dusting powder**

Dusting powders should only be used for the packaging of rubber items in order to prevent adhesion. In such cases, the minimum quantity of powder to prevent adhesion should be used. Any powder used should be free from any constituent that would have a harmful effect on the rubber or the subsequent application of the rubber.

**Contact between different products**

Contact between products made from rubbers of different compositions should be avoided. This includes products of the same type but differing in color.

**Rubber-to-metal bonded products**

The metal part of rubber-to-metal bonded products should not come into contact with the rubber of other products. Preservative used on the metal should be of a type that it will not adversely affect the rubber or the bond to such an extent that it does not comply with the product specification.

**Storage life**

This is the maximum period of time that a rubber product, appropriately packaged, may be stored. After this time the product is regarded as unserviceable for the purposes for which it was originally manufactured. The storage life of a rubber product is influenced by its shape and size as well as its composition. Thick products usually undergo slower changes through degradation than thinner ones.

**Initial storage period**

This is the maximum period, starting from the time of manufacture, for which a rubber product, appropriately packaged, may be stored under specified conditions before a sample needs to be inspected or re-tested.

**Extension storage period**

This is the period for which a rubber product, appropriately packaged, may be stored after the initial storage period, before further inspection and re-testing is necessary.

**Assembly**

These are products or components containing more than one element, one or more of which is made of rubber. Generally it is not recommended to store elastomeric products in an assembled condition. If it is necessary to do so, the units should be checked more often. The inspection interval depends on the design and geometry of the components.

**Inspection before extension storage**

Before any items are to be stored for an extension period, representative samples of each type should be selected for inspection at the end of the appropriate initial storage period. Inspection should be in accordance with the relevant product specification.

**Visual inspection**

Inspect each of the items for the following:

1. Permanent distortions, such as creases or flats.
2. Mechanical damage, such as cuts, tears, abraded areas or delaminated plies.
3. Surface cracking when viewed under a microscope at x10 magnification.
4. Changes in surface condition, such as hardening, softening or tackiness.

**Assessment at the end of the initial period**

If, following the visual inspection procedure the items are not satisfactory, they should not be stored for an extended period. If the items are satisfactory and are stored for an extended period a record should be kept of the date initial storage began as well as the date the extended storage period began. Items stored for an extended period should be inspected and tested at, or before, the expiry of the extension storage period before they are put into service or stored for a further extended period.

**Table 52: Initial and extension storage periods for unassembled components**

Material Group	Initial Storage Period	Extended Storage Period
AU, EU, NR, SBR	5 years	2 years
ACM, AEM, CR, ECO, HNBR, IIR, NBR	7 years	3 years
CSM, EPDM, FKM, FMQ, FVMQ	10 years	5 years
FFKM Isolast®	20 years	5 years
Zurcon®	10 years	5 years
PTFE	unlimited	

Note 1: If the storage temperature is over or under +25 °C (+77 °F) this will influence the storage time. Storage at +10 °C (+50 °F) higher will reduce the storage time by about 50%. Storage at +10 °C (+50 °F) lower will increase the storage time by around 100%.

Note 2: In application areas such as aerospace the storage periods can differ from this specification. These specific storage conditions have to be agreed between the supplier and the buyer.





**Table 53: SI - Basic Units**

Measures	Units	Symbol
Length	Metre	m
Mass	Kilogram	kg
Time	Second	s
Electric current	Ampere	A
Temperature	Kelvin	K
Luminous intensity	Candela	cd
Amount of substance	Mol	mol

**Table 54: Length**

	inch	foot	yard	mm	metre
1 inch =		0.0833	0.0278	25.4	0.0254
1 foot =	12		0.333	304.8	0.3048
1 yard =	36	3		914.4	0.9144
1 mm =	0.03937	0.0033	0.00109		0.001
1 metre =	39.37	3.2808	1.0936	1,000	

**Table 55: Torque**

	inch-ounce	inch-pound	foot-pound	kg-metre	Newton-metre
1 inch-ounce =		0.0625	0.0052	7.2x10 <sup>-4</sup>	7.06x10 <sup>-3</sup>
1 inch-pound =	16		0.0833	1.152x10 <sup>-2</sup>	0.1130
1 foot-pound =	192	12		0.1383	1.356
1 kg-metre =	1,388.7	86.796	7.233		9.80665
1 Newton-metre =	141.6	8.850	0.7375	0.1020	

**Table 56: Area**

	inch <sup>2</sup>	foot <sup>2</sup>	yard <sup>2</sup>	mm <sup>2</sup>	m <sup>2</sup>
1 inch <sup>2</sup> =		0.0069	0.00077	645.16	6.45x10 <sup>-4</sup>
1 foot <sup>2</sup> =	144		0.111	92,903	0.0929
1 yard <sup>2</sup> =	1,296	9		836,100	0.8361
1 mm <sup>2</sup> =	0.0016	1.0764x10 <sup>-5</sup>	1.196x10 <sup>-6</sup>		10 <sup>-6</sup>
1 m <sup>2</sup> =	1,550	10.764	1.196	106	

**Table 57: Volume**

	inch <sup>3</sup>	US quart	imp. gallon	foot <sup>3</sup>	US gallon	liter
1 inch <sup>3</sup> =		0.0173	0.0036	0.00058	0.0043	0.0164
1 US quart =	57.75		0.2082	0.0334	0.25	0.9464

**Table 63: Pressure**

	inch Hg	psi	atmosphere	torr	mm Hg	bar	MPa	kg/cm <sup>2</sup>
1 inch Hg =		0.491	0.0334	25.4	25.4	0.0339	0.00339	0.0345
1 psi =	2.036		0.0680	51.715	51.715	0.0689	0.00689	0.0703
1 atmosphere =	29.921	14.696		760	760	1.0133	0.10133	1.0332
1 torr =	0.0394	0.0193	0.0013		1	0.0013	0.00013	0.00136
1 mm Hg =	0.0394	0.0193	0.0013	1		0.0013	0.00013	0.00136
1 bar =	29.53	14.504	0.987	749.87	749.87		0.1	1.020
1 MPa =	295.3	145.04	9.869	7498.7	7498.7	10		10.2
1 kg/cm <sup>2</sup> =	28.950	14.22	0.968	735.35	735.35	0.980	0.098	

	inch <sup>3</sup>	US quart	imp. gallon	foot <sup>3</sup>	US gallon	liter
1 imp. gallon =	277	4.8		0.1604	1.2	4.546
1 foot <sup>3</sup> =	1,728	29.922	6.23		7.48	28.317
1 US gallon =	231	4	0.8327	0.1337		3.785
1 liter =	61.024	1.0567	0.220	0.0353	0.264	

**Table 58: Temperature**

	°K (Kelvin)	°C	°F
°K =		°C + 273.15	(°F - 459.67) 5/9
°C =	°K - 273.15		(°F - 32) 5/9
°F =	°K 9/5 - 459.67	°C 9/5 + 32	

**Table 59: Density**

	ounce/inch <sup>3</sup>	pound/foot <sup>3</sup>	g/cm <sup>3</sup>
1 ounce/inch <sup>3</sup> =		108	1.73
1 pound/foot <sup>3</sup> =	0.0092		0.016
1 g/cm <sup>3</sup> =	0.578	62.43	

**Table 60: Force**

	Newton (N)	kilopond (kp)	pound force
1 Newton (N) =		0.10197	0.22481
1 kilopond (kp) =	9.80665		2.20463
1 pound force =	4.4482	0.45359	

**Table 61: Velocity (Speed)**

	foot/s	foot/min	mile/hour	metre/s	km/hour
1 foot/s =		60	0.6818	0.3048	1.097
1 ft/min =	0.017		0.0114	0.00508	0.01829
1 mile/hour =	1.4667	88		0.447	1.609
1 metre/s =	3.280	196.848	2.237		3.6
1 km/h =	0.9113	54.68	0.6214	0.278	

**Table 62: Mass**

	ounce	pound	kg
1 ounce =		0.0625	0.0283
1 pound =	16		0.4536
1 kg =	35.274	2.2046	

# Welcome to Trelleborg Sealing Solutions

## SEALING TECHNOLOGY

Trelleborg Sealing Solutions offers an outstandingly comprehensive sealing portfolio – a one-stop-shop providing the best in elastomer, silicone, thermoplastic, PTFE and composite technologies; solutions that feature in virtually every application conceivable within the aerospace, industrial and automotive industries.

## A WORLDWIDE PRESENCE

We are uniquely placed to offer a dedicated design and development service for sealing solutions; globally servicing, supporting and supplying customers through an unrivaled international network.

## COMMITMENT TO CUSTOMER, NEEDS LONG-TERM

Trelleborg Sealing Solutions is one of the world's foremost experts in polymer sealing technology. Using our expertise and experience, we facilitate customers in achieving cost-effective, durable solutions that match their specific business requirements.



### Trelleborg Sealing Solutions -

### Your Partner for Sealing Technology

Scan the QR-Code to watch the movie about our ability to add value and improve the business of our customers.

# A world leader in engineered polymer solutions

## THE TRELLEBORG GROUP



**Trelleborg Coated Systems**  
 Leading global supplier of unique customer solutions for polymer-coated fabrics deployed in a variety of industrial applications.



**Trelleborg Industrial Solutions**  
 Market leader in such industrial application areas as hose systems, industrial antivibration solutions and selected industrial sealing systems.



**Trelleborg Offshore & Construction**  
 Leading global supplier of polymer-based critical solutions for deployment in highly demanding environments.



**Trelleborg Wheel Systems**  
 Trelleborg Wheel Systems is a leading global supplier of tires and complete wheels for agricultural and forestry machines, materials handling and construction vehicles, and two-wheeled vehicles.



**Trelleborg Sealing Solutions**  
 One of the world's leading developers, manufacturers and suppliers of precision seals. It supports its aerospace, industrial and automotive customers through over 20 production facilities and more than 50 marketing companies globally.

### BLUE DIMENSION™



At Trelleborg we believe that the benefits of our solutions stretch beyond functionality and business performance.  
**For more information scan the QR-Code or visit the website: [www.trelleborg.com](http://www.trelleborg.com)**



# Our Global Resources

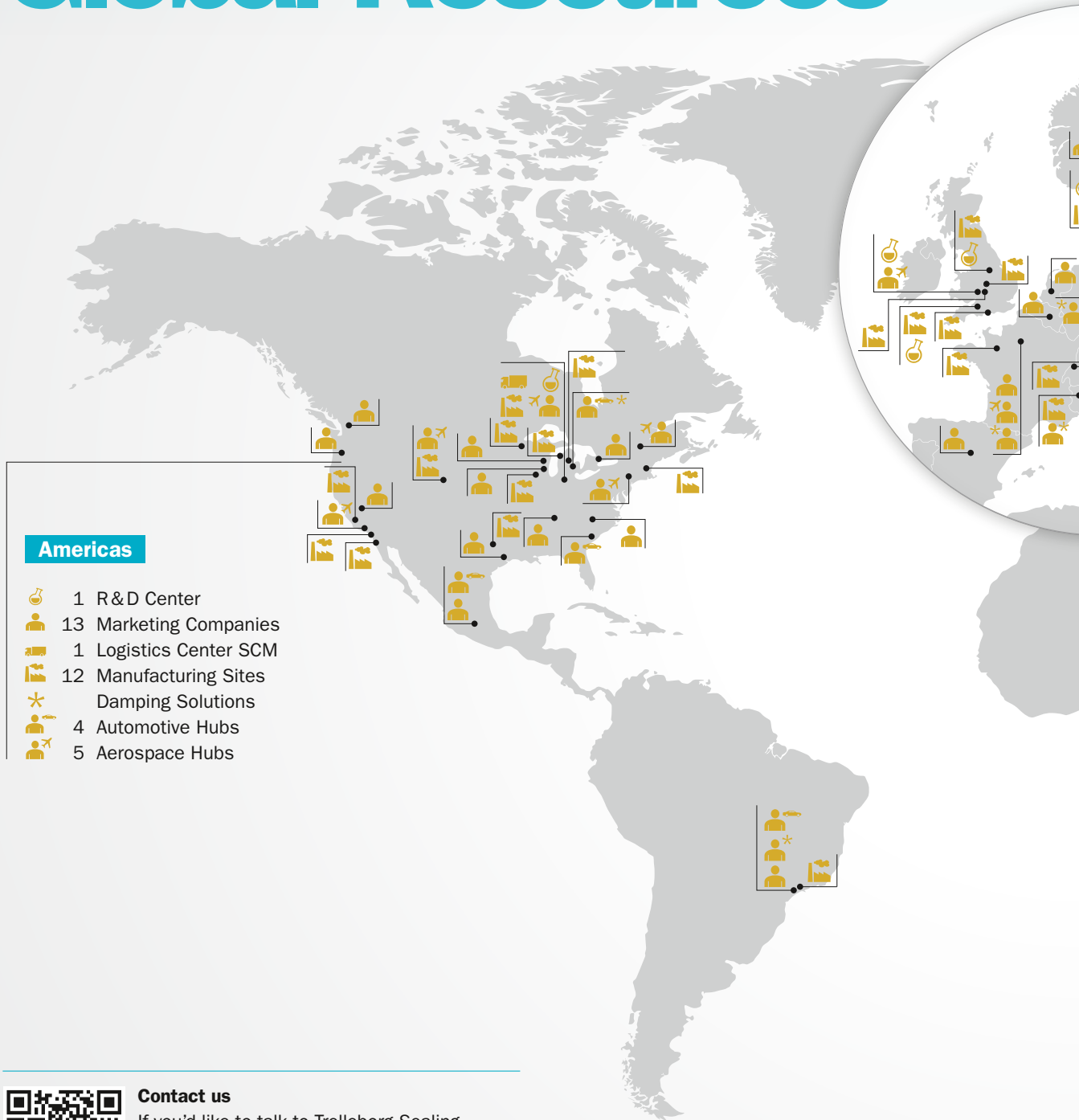

**Contact us**

If you'd like to talk to Trelleborg Sealing Solutions, find your local contact at:

[www.tss.trelleborg.com/worldwide](http://www.tss.trelleborg.com/worldwide)

**6,799**  
employees

**82**  
worldwide  
locations

More than  
**2,000**  
proprietary material  
formulations

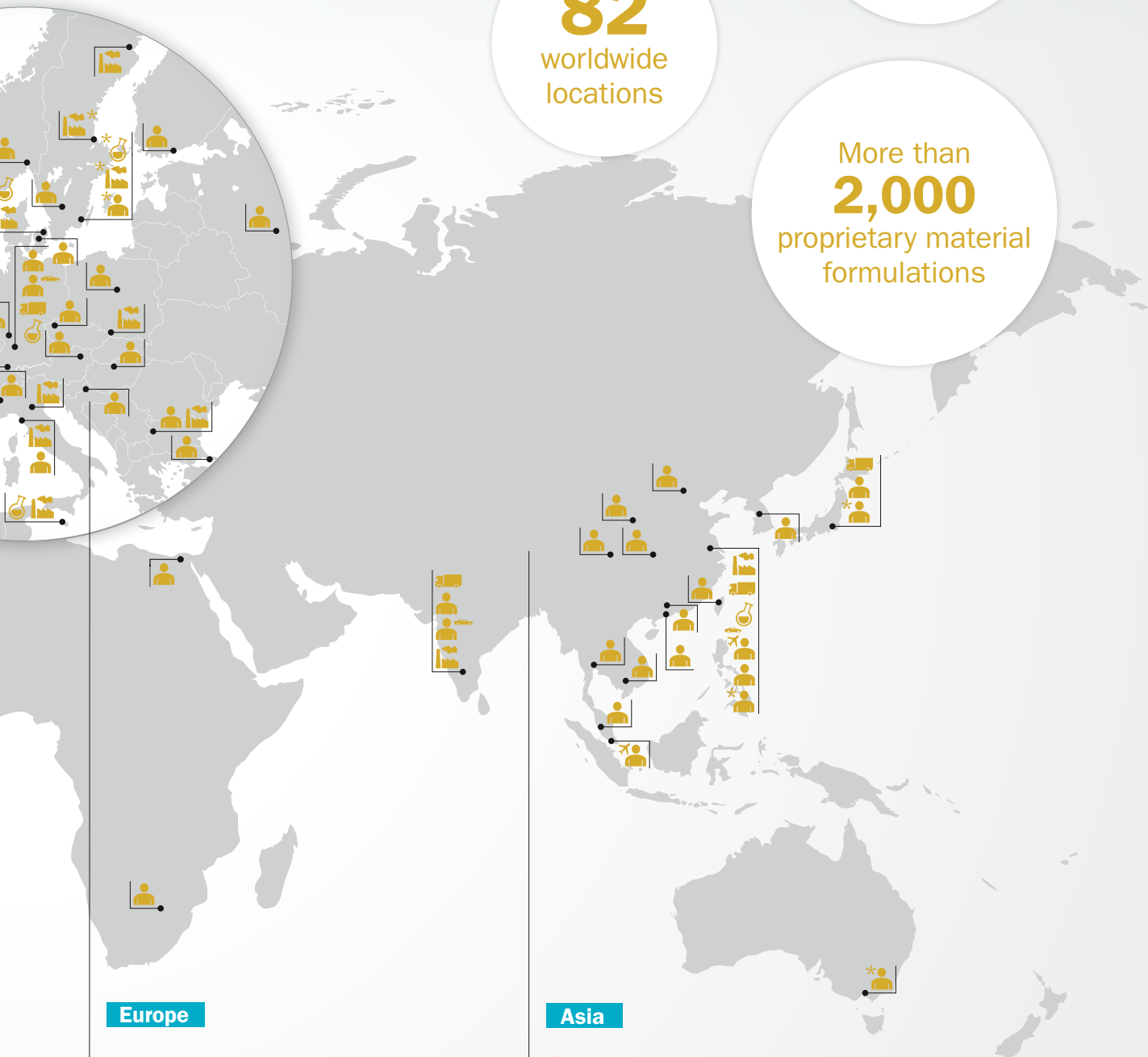
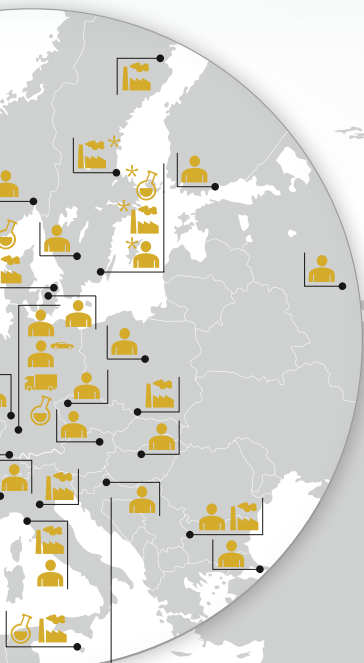

**Europe**

-  7 R&D Centers
-  22 Marketing Companies
-  1 Logistics Center SCM
-  17 Manufacturing Sites
-  Damping Solutions
-  1 Automotive Hub
-  2 Aerospace Hubs

**Asia**

-  1 R&D Center
-  16 Marketing Companies
-  3 Logistics Centers SCM
-  2 Manufacturing Sites
-  Damping Solutions
-  2 Automotive Hubs
-  2 Aerospace Hubs

# Products, Brands & Materials

Decades of experience designing and manufacturing polymer solutions has led Trelleborg Sealing Solutions to develop, manufacture and supply a range of unique materials and proprietary product designs, many of which have become industry standards. Development is ongoing, ensuring that our solutions meet the changing needs of our customers, as well as the latest industry trends and regulations.

## PRODUCTS



Fluid Sealing Systems



Static Seals



Bearings & Bushings



Rotary Seals



Medical Components

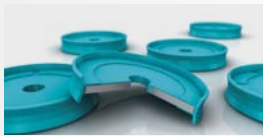

Pneumatic Seals



O-Rings



Engineered Molded Parts



Mechanical Face Seals (Heavy Duty Seals)



HiMod® FlatSeal™ Gaskets



Brake Shims, Tuned Absorbers, Rubore® seals



Assembly Units



Liquid Silicone Rubber (LSR)



Customized Aerospace Sealing



Tubing & Hose Sealing

## WORLD RENOWNED NAMES UNITED

We own many of the longest established and leading names within the seal industry. These include:

- American Variseal
- Automated Dynamics
- Busak+Shamban
- Dowty Seals
- Chase Walton
- Forsheda
- GNL
- Impervia
- Nordex
- Orkot
- Palmer Chenard
- Polypac
- SSF
- SF Medical
- Shamban
- Silcofab
- Silcotech
- Sil-Pro
- Skega
- Stefa
- Wills

## PROPRIETARY MATERIALS

Ongoing development has yielded some of the most successful sealing and bearing materials available:

- HiMod®
- HiPlast®
- Isolast®
- Orkot®
- Turcite®
- Turcon®
- Turel®
- Zurcon®



### One-Stop-Shop for Sealing Solutions

Scan the QR-Code or visit our website to find out more about our portfolio of solutions for industry-specific needs and applications.

[www.tss.trelleborg.com](http://www.tss.trelleborg.com)



# Your Industry



Aerospace



Agriculture



Automotive



Construction & Mining Equipment



Fluid Power - Hydraulics



Fluid Power - Pneumatics

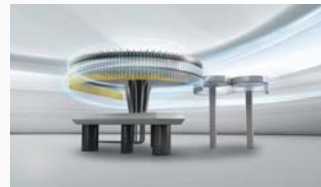

Food & Beverage



Healthcare & Medical



Manufacturing & Machine Tools



Marine Equipment & Construction



Oil & Gas



Processing Equipment



Renewable Energy & Power Generation



Robotics

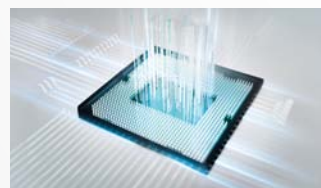

Semiconductor



Water & Sanitary



**Accelerating performance in your industry**  
Scan the QR-Code or visit our website to find out more about our tailor-made solutions for your industry.  
[www.tss.trelleborg.com](http://www.tss.trelleborg.com)





# Films & Animations

## SEEING IS BELIEVING

Complex sealing configurations can feature a large number of sealing elements. Trying to illustrate these on a 2-D page is difficult and can never properly show their function or characteristics. Trelleborg Sealing Solutions uses the latest graphic technologies to produce 3-D animations of applications and typical sealing solutions for them.



View at  
[YouTube.com/  
trelleborgseals](https://www.youtube.com/trelleborgseals)  
YouTube

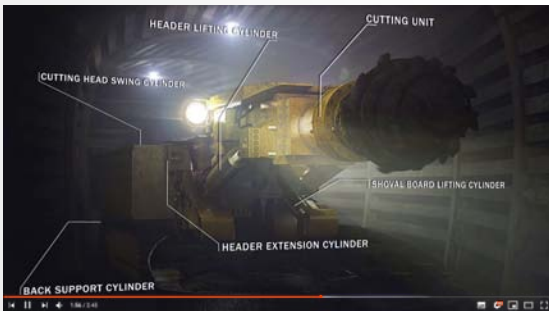

View at  
[tss.trelleborg.com/  
films](https://tss.trelleborg.com/films)  
TSS



### Films and Animations online

A range of films specific to different industries and products are available to view on the Trelleborg Sealing Solutions website or via YouTube.



# Simplify Your Business ServicePLUS

ServicePLUS aims at uniting various enhanced solutions across the entire value chain, simplifying the processes of engineering, logistics, manufacturing and aftermarket for the customer.



Engineering

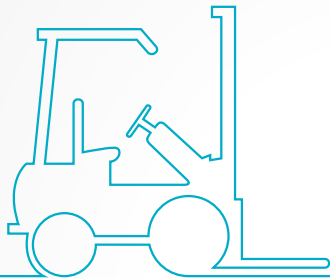

Logistics

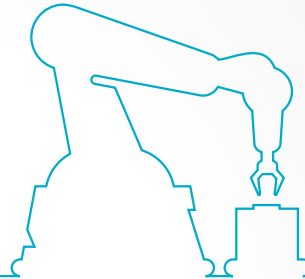

Manufacturing



Aftermarket



## SPECIAL HANDLING

Special Handling bundles an assortment of individual packaging solutions together with additional services that optimize the mounting and handling of seals.



## ADVANCED DELIVERY

Our Advanced Delivery services simplify your stock replenishment process by managing your different vendors and stock levels – be it through a Kanban system or complete C-Part Management.



## ENGINEERING SUPPORT SERVICES

Trelleborg provides world-class expert support for your engineering needs, from extensive design & compound competence to leading edge product testing.



## ASSEMBLY

Trelleborg is willing and able to offer pre-assembled parts put together by specially trained staff, delivered directly to you.



## QUICKSEAL

QuickSeal covers your short-notice needs for sealing solutions, whether you require a prototype, functional sample or a small batch rapidly.



## DIGITAL TOOLS

Online resources and apps developed to make an engineer's life easier.

Discover our wide range of digital tools at [www.tss.trelleborg.com](http://www.tss.trelleborg.com)





Scan the QR-Code to  
learn how you can  
simplify your business  
with ServicePLUS:



# Design Support & Engineering Tools

## ONLINE TOOLS MAKE LIFE EASIER

Trelleborg Sealing Solutions has developed a number of online tools that make the working life of an engineer specifying seals easier. All these industry-leading tools are available free-of-charge from the Trelleborg Sealing Solutions website at [www.tss.trelleborg.com](http://www.tss.trelleborg.com). To use these advanced services all you have to do is register on the Members Area.

There is also a continually increasing range of innovative engineering apps available for smartphones, both for iOS and Android devices. Just search for "Trelleborg" in the App Store or GooglePlay to find the tools to optimize your daily productivity.

## Materials Search and Chemical Compatibility Check

These two programs allow you to find out the compatibility of sealing materials with hundreds of different media and help identify the most suitable material for your application.

- + Very good suitability
- Good suitability
- Limited suitability
- ✗ Unsuitable
- ? Insufficient information

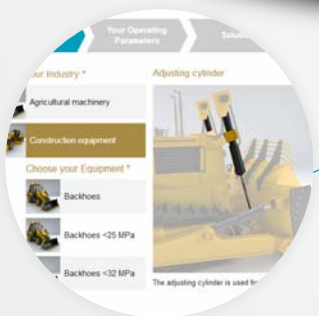
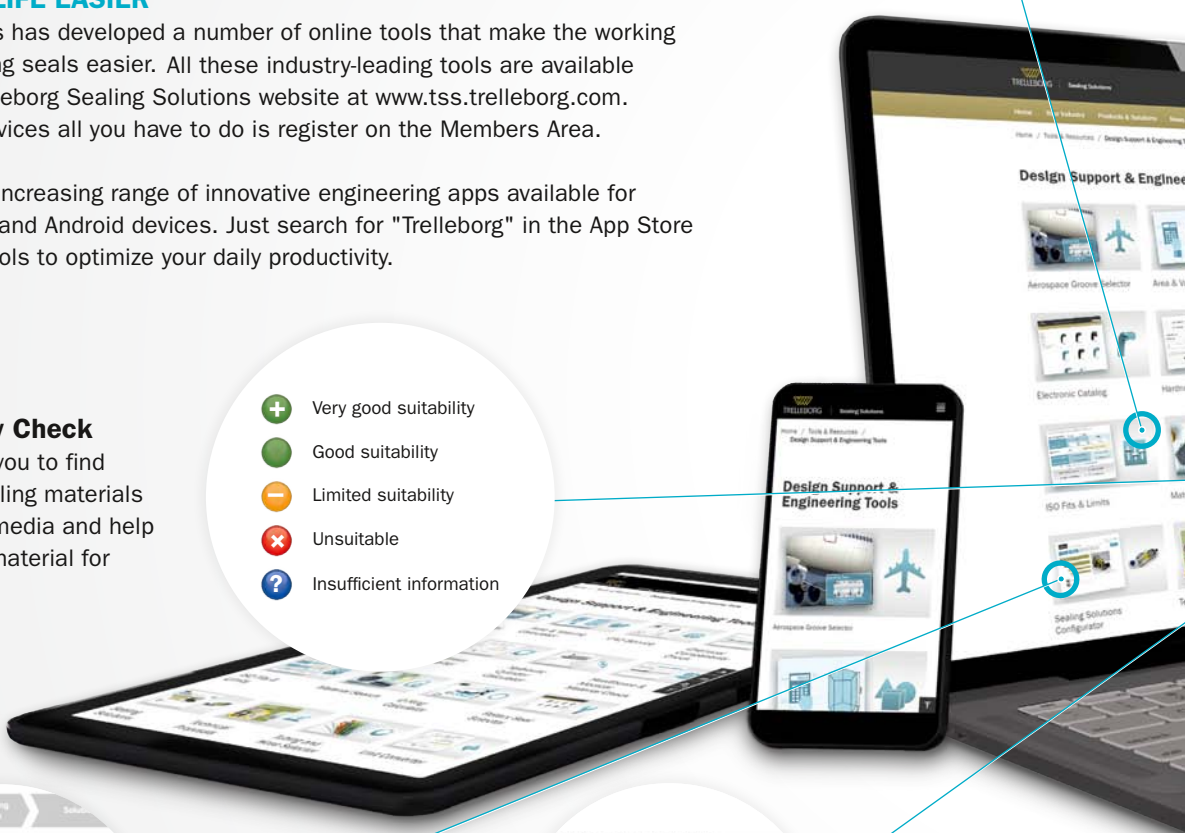

## Sealing Solutions Configurator

The Sealing Solutions Configurator is the first tool of its kind offered by any seal supplier. It allows engineers to identify a proven sealing solution for their specific application in just four easy steps.

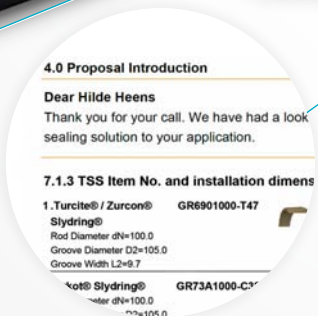

## Technical Proposals Online

Enhance your communication with Trelleborg Sealing Solutions with the Technical Proposals Online tool. Instantly access all your proposed solutions anywhere at any time and benefit from quicker dialog with our sealing specialists.



**ISO Fits & Tolerances**

Our Fits & Tolerances Calculator allows you to easily determine type of fits using the tolerances according to DIN ISO 286. In addition, upon entering the nominal diameter the tool calculates lower and upper limit deviations plus the maximum and minimum interferences dependent on the selected tolerance classes for bore and shaft.



**Versatile CAD Service**

The CAD download functionality provides thousands of drawings of a wide range of seals. It gives the option of 2- or 3-dimensional files in a range of formats to suit most commonly used CAD systems.



**Hydraulic System Calculator**

Hydraulic System Calculator helps you design a solution around the cylinder which may involve motor, pump, orifice and pipe calculations. The application is in compliance with ISO 3320, ISO 3321 & ISO 4393.



**Rotary Seal Selector**

The Rotary Seal Selector allows you to search through the wide range of rotary seals and materials available based on application conditions and offers detailed information on installation and seal capabilities.



**O-Ring Calculator**

An industry-leading tool, the easy to use O-Ring calculator includes sizing capabilities, compression forces, design parameter recommendations and complete measurements. Results and comments may be printed, shared or filed as PDF.

Discover our design support and engineering tools at [www.tss.trelleborg.com](http://www.tss.trelleborg.com)



# Mobile Tools & Apps

We understand the needs of engineers on the go. Check out our latest mobile tools and apps, ranging from an O-Ring calculator to unit and hardness converters. Just search for "Trelleborg" in the App Store or Google Play to find the tools to optimize your daily productivity.



MANY MORE APPS available



Discover our wide range of mobile tools and apps at [www.tss.trelleborg.com](http://www.tss.trelleborg.com)

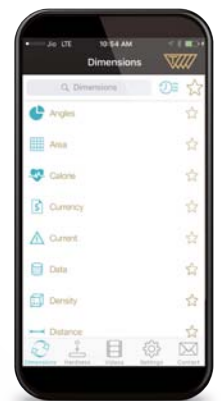
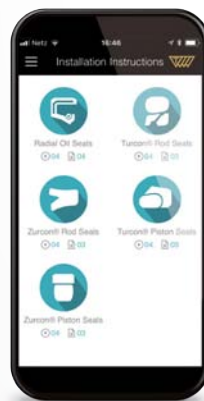
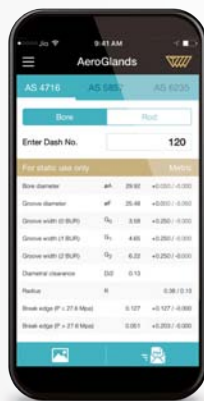

### ISO Fits & Tolerances

Simply enter the nominal diameter and select the tolerance classes for bore and shaft to find the complete ISO fits definition with all relevant values including type of fit, with handy graphs to illustrate the classes by bore and shaft.



### Mechanical Engineering Calculator

An excellent tool offers over 244 formulas in 16 categories, with more being added every update. Categories include the fields of mathematics, physics and mechanical engineering.



### Aerospace Groove Selector

This app covers two of the most important SAE aerospace groove standards for hydraulic systems, AS4716 Rev B and AS5857 Rev A, making it really easy to find the size of grooves and hardware needed.



### Installation Instructions

Videos demonstrate the best practice methods for installing seals, providing all relevant documentation within the interface, guiding you to a successful installation of Radial Oil Seals and Turcon® and Zurcon® rod and piston seals.



### Unit & Hardness Converter

By simply selecting the dimension and entering the value for conversion, the app offers a wide range of engineering and scientific units for each dimension.





**in the groove**

Our *in the groove* magazine provides news, technical and product information on seals, as well as insights into the markets they are used in. The magazine is also available in print and as an interactive PDF.



**Rotary Seal Selector**

Bring the popular Rotary Seal Selector webtool with you! Quickly search through Trelleborg Sealing Solutions rotary seals and materials for the optimum product for your application conditions while on the move.

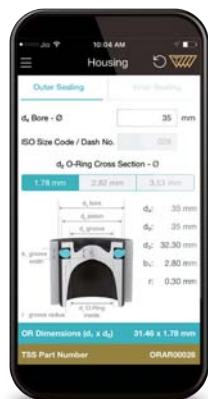

**O-Ring Selector**

When a user enters installation specifications into the O-Ring Selector app, such as the bore or rod/shaft diameter, the app quickly calculates O-Ring and housing dimensions in both metric and inch.

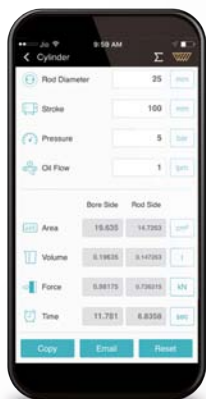

**Hydraulic System Calculator**

Hydraulic System Calculator helps you design a solution around the cylinder which may involve motor, pump, orifice and pipe calculations. The application is in compliance with ISO 3320, ISO 3321 & ISO 4393.

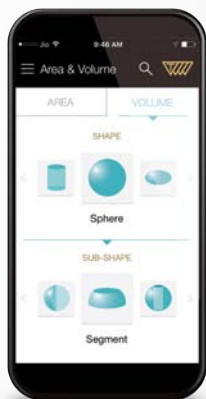

**Area and Volume Calculator**

Speeds up and simplifies calculating the area and volumes of more than 80 geometric shapes. The app supports both metric and imperial units and conveniently displays the formulas used. Fill your shape with solids or liquids, choosing from 1500 different materials, to calculate the weight.



**Healthcare Materials**

View a quick and easy overview of the compatibility of 34 materials with 35 chemical environments that are commonly encountered in the healthcare and medical industries. Select up to 20 materials and environments at once to produce a chart rating each material from "excellent" to "not recommended".

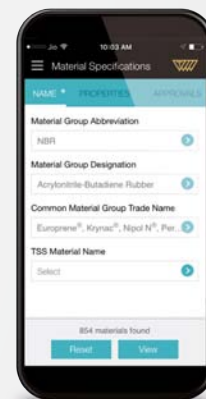

**Sealing Materials Selector**

Enter material specifications and required parameters, such as application temperature or hardness, to receive instant material proposals. The app features filters to limit searches based on chemical compatibility, institute approvals and product type and data sheets can be requested from within the interface.

# Electronic Catalog

Discover the Electronic Catalog online as an app or on our website



The Electronic Catalog is a user-friendly service that connects you to the broad range of products Trelleborg Sealing Solutions offers. The products are arranged based on product type and product group, making it easy to find the exact one you need.

Many functions are also included within the Electronic Catalog that allow you to understand product capabilities, compare similar seals, request a quote and much more. The Electronic Catalog is available from the Trelleborg Sealing Solutions website and in the App Store and GooglePlay for mobile use.

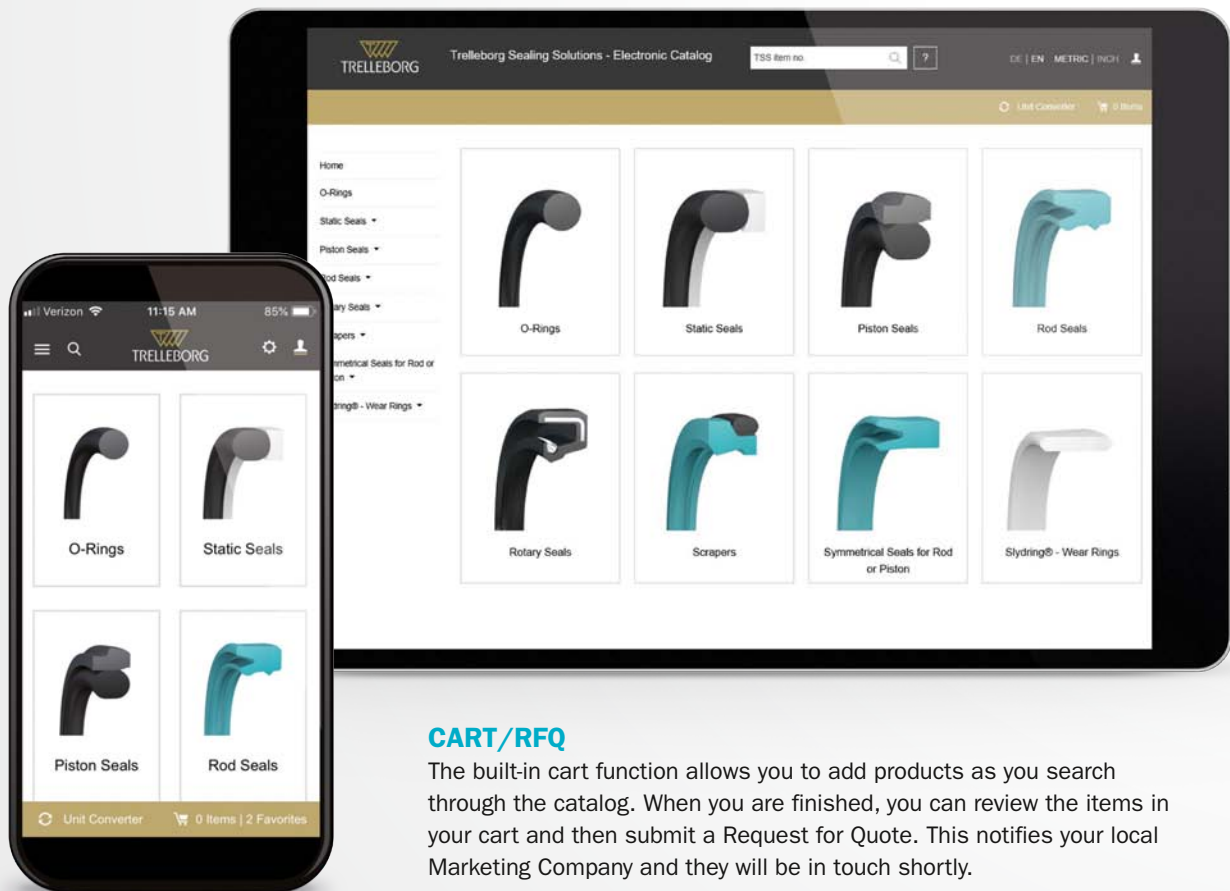

## CART/RFQ

The built-in cart function allows you to add products as you search through the catalog. When you are finished, you can review the items in your cart and then submit a Request for Quote. This notifies your local Marketing Company and they will be in touch shortly.

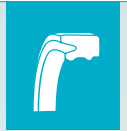

### FILTERING

If you have specific operating conditions that the seal must meet and/or installation dimensions, the Electronic Catalog offers a filtering function within the product groups. Here you can input your temperatures, pressure, speed and various installation dimensions to filter products that can meet your needs.

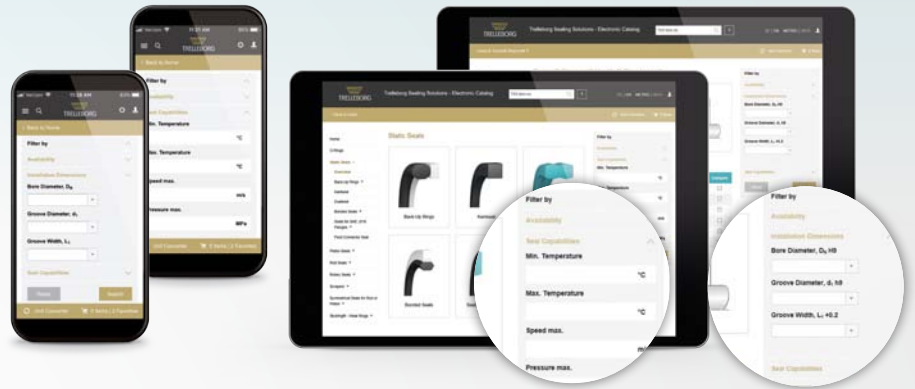

### PRODUCT COMPARISON

When looking through the catalog, you can choose to compare multiple products. The product comparison function allows you to select which products you are interested in, and then puts all relevant information into a table for your review. You can even choose to display all product details side by side or to only show the fields where they differ.

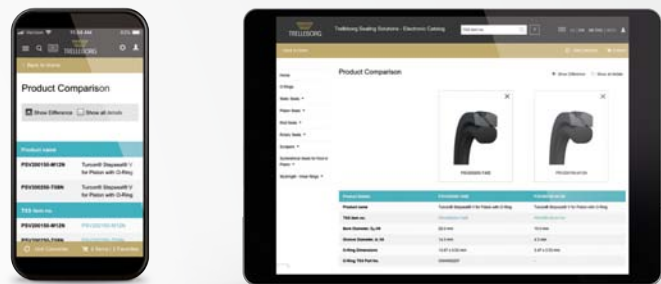

### PRODUCT INFORMATION

Detailed product information is available for each part number. Once you select a specific part number, you will be able to see its installation dimensions, seal capabilities, related catalogs and other information. From this page, registered users can access the material data sheets that are applicable to the part number.

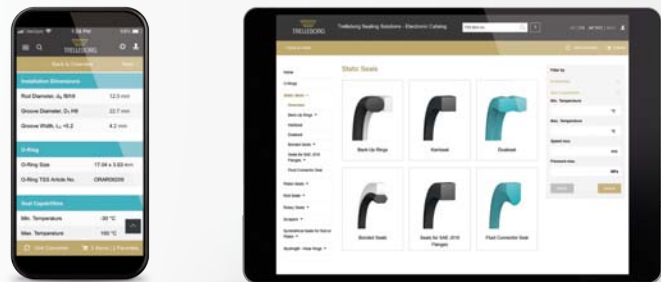

### ADD TO FAVORITES

Do you have a part that you frequently look up or need information on? You can now save any of our part numbers as a favorite that is linked to your account. Anytime you log in to the Electronic Catalog, your favorites will be a click away!

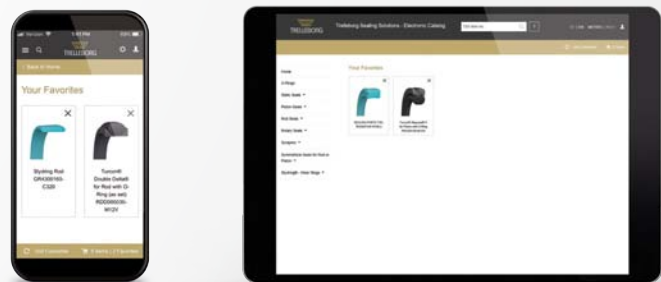

### UNIT CONVERTER

If you are looking at a product and need to know the conversion between metric and imperial, you can use the Unit Converter tool that is available at the top of the screen for web users and at the bottom for mobile.

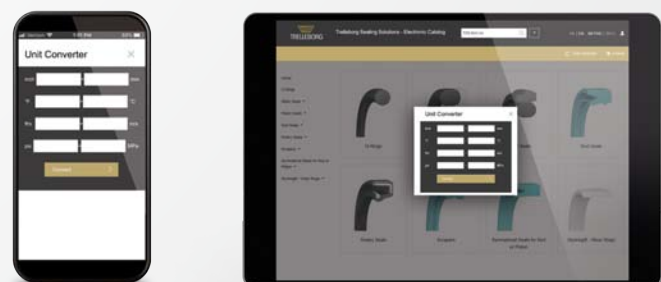



Trelleborg is a world leader in engineered polymer solutions that seal, damp and protect critical applications in demanding environments. Its innovative solutions accelerate performance for customers in a sustainable way.

Trelleborg Sealing Solutions is a leading developer, manufacturer and supplier of precision seals, bearings and custom-molded polymer components. It focuses on meeting the most demanding needs of aerospace, automotive and general industrial customers with innovative solutions.

[WWW.TSS.TRELLEBORG.COM](http://WWW.TSS.TRELLEBORG.COM)



[facebook.com/TrelleborgSealingSolutions](https://facebook.com/TrelleborgSealingSolutions)  
[twitter.com/TrelleborgSeals](https://twitter.com/TrelleborgSeals)  
[youtube.com/TrelleborgSeals](https://youtube.com/TrelleborgSeals)  
[linkedin.com/company/trelleborg-sealing-solutions](https://linkedin.com/company/trelleborg-sealing-solutions)

If you'd like to talk to Trelleborg Sealing Solutions, find your local contact at: [www.tss.trelleborg.com/worldwide](http://www.tss.trelleborg.com/worldwide)