

**SCHRÖDER**  
GROUP



FOLDING MACHINE  
**PowerBend Professional**

# PowerBend Professional

The PowerBend Professional folding machine is the professional solution to your thin sheet metal applications. This robust yet precise folder is ideal for continuous operation in large workshops, mid-sized companies and the industry.

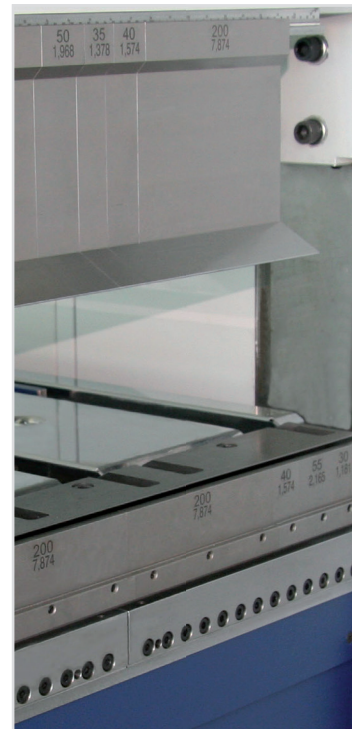

The motor-driven lowerable folding beam and the motorized folding centre adjustment are included in the standard version.

The PowerBend platform is based on decades of experience in industrial folding machines. It was engineered using state of the art tools, and finite element analysis. The resulting rigid frame provides a base from which the PowerBend achieves unmatched speed, precision, and operational efficiency.

Thanks to the optionally available segmented tools on all beams, superior drive technology and advanced electronic control, the PowerBend Professional can handle complex geometries and difficult bending requirements with ease.

## Long or short runs

Challenging requirements in your industrial series production? The PowerBend Professional possesses the necessary robustness, reliability and repeat accuracy. At the same time the machine offers the flexibility your company needs for the production of short runs and prototypes. With the hydraulic tool clamping device and the optional rotating clamping beam, set up times can be drastically reduced. The result is a considerable increase in productivity.



Standard equipment	
Software control	<ul style="list-style-type: none"> <li>– POS 2000 Professional PC based graphic control with touchscreen on swivelling arm</li> </ul>
Clamping beam	<ul style="list-style-type: none"> <li>– Drive: 3.0 kW, center drive (converter controlled, 20 mm/sec)</li> <li>– Trapezoidal spindle</li> <li>– Stroke: 350 mm</li> <li>– Clamping beam orientation: 48° or optionally 180°</li> <li>– Tool clamping device, hydraulic</li> </ul>
Folding beam	<ul style="list-style-type: none"> <li>– Drive: 2 x 2.2 kW (converter controlled, 85°/sec)</li> <li>– Tool clamping device, pneumatic</li> <li>– Adjustment, motorized: 80 mm</li> <li>– Folding centre adjustment, motorized: ± 20 mm</li> <li>– Crowning device, manual</li> </ul>
Bottom beam	<ul style="list-style-type: none"> <li>– Bottom beam blade 700N/mm<sup>2</sup> one-piece with finger grooves; Minimal gauge 10 mm (varies according to equipment)</li> </ul>
Back gauge system	<ul style="list-style-type: none"> <li>– Sheet support table with gauge up to 1600 mm (closed; 2 sectors with pneumatic lowering device, sheet support table with balls; recirculated ball screws (+/- 0,1 mm))</li> </ul>
Others	<ul style="list-style-type: none"> <li>– Radius-Step-Bending-Function</li> <li>– Footswitch</li> <li>– Anchor plates incl. dowels</li> </ul>

Special equipment	
Clamping beam	<ul style="list-style-type: none"> <li>– Drive: 2 x 2.2 kW, center drive (65 mm/sec), axis with recirculated ball screws</li> <li>– Rotating clamping beam for two tool stations incl. hydraulic tool clamping device on both sides (requires 2 x 2.2 kW clamping beam drive)</li> </ul>
Folding beam	<ul style="list-style-type: none"> <li>– Central crowning device, motorized</li> <li>– High speed folding beam: 2 x 3.0 kW, 105°/sec</li> </ul>
Up and Down-Technology package	<ul style="list-style-type: none"> <li>– Operation from the front and the rear</li> <li>– When operating from the front: only up-bends possible</li> <li>– 2 x 2.2 kW Z-axis drive with recirculated ball screws</li> <li>– Motorized crowning device</li> <li>– Remote maintenance</li> <li>– External programming</li> <li>– Tilting of the clamping beam for improved performance</li> <li>– Up and Down bottom beam blade, one-piece, ca. 1100 N/mm<sup>2</sup>, 30°, R 1/1,5/3,0 with finger grooves, minimal gauge 10 mm</li> <li>– Folding beam adjustment 160 mm (converter controlled)</li> <li>– U-gauge up to 1600 mm (2 sectors, balls in table)</li> <li>– Protection from the front via light barrier</li> <li>– 2nd footswitch on rail for lateral movement</li> </ul>
Machine operation	<ul style="list-style-type: none"> <li>– 2-man-operation</li> <li>– Additionally operation from the rear (2nd footswitch and protection via light barrier)</li> <li>– Footswitch on rail for lateral movement</li> </ul>
Others	<ul style="list-style-type: none"> <li>– Options for back gauge, please see p. 5 and p. 11</li> <li>– Options for software control, please see p. 8-9</li> <li>– Tools, please see p. 7</li> </ul>

# Options for increasing ergonomic efficiency

The PowerBend Professional comes extensively equipped to handle most jobs with ease. And for specific requirements, additional options are available, adding even more production efficiencies.

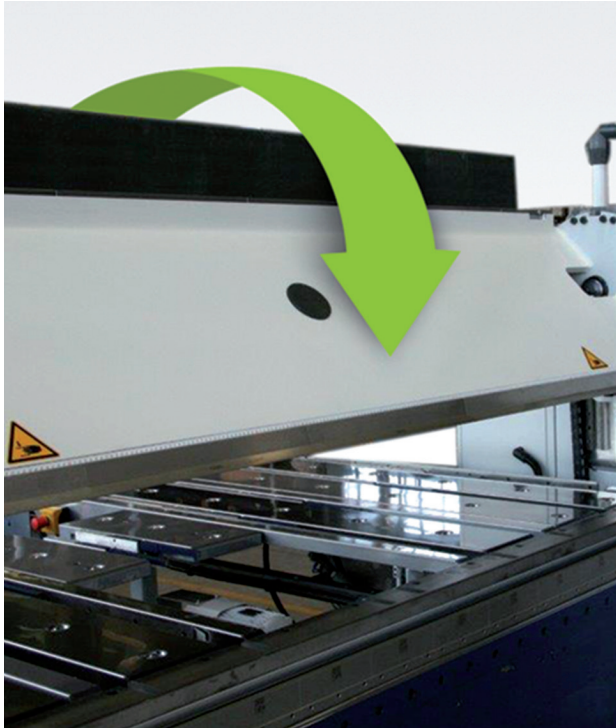

The rotating clamping beam offers a second set of tools and an alternative machine geometry

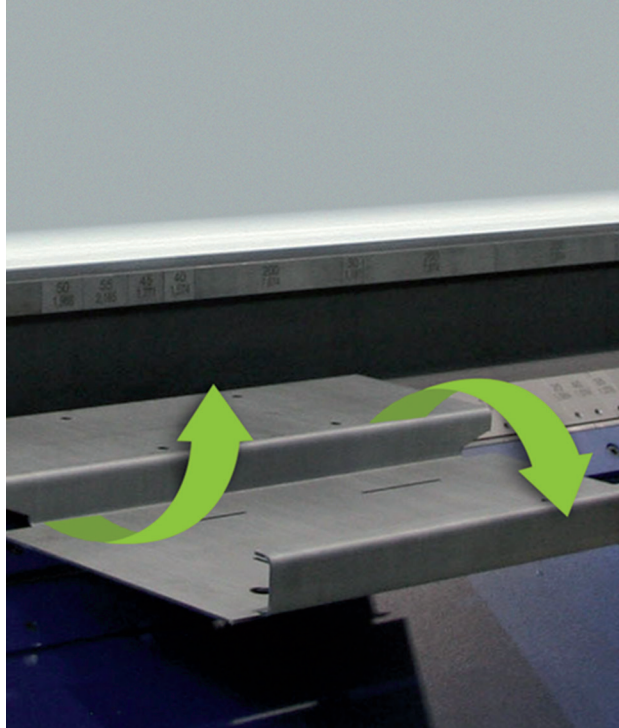

Up and Down function: counter folds without turning around the sheet.

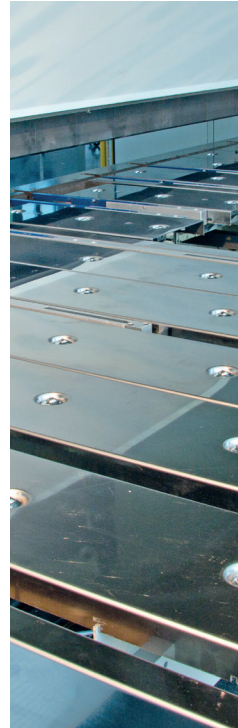

Fast changing jobs or complex tasks with different folding tools – the PowerBend Professional is open to all customer requirements. With the optional, rotating clamping beam the PowerBend Professional always has ready a second set of tools as well as an alternative machine geometry. – that creates clearances in your production. Where the set-up of other folding machines is extremely time-consuming, the PowerBend Professional is running without interruption and reduces set-up times.

## Up and Down bi-directional folding beam

You will love this option: The Up-and-Down-folding beam allows counterfolds in one processing step, e.g. boxes with Z-bends. With the Up-and-Down function the folding beam is able to move around the work-piece, being able to bend from below and from above. For counter foldings the sheet therefore does not need to be turned around. Especially for big sheet this means: less helping hands, less muscle power, lower level of risk for material surfaces. In short: better ergonomics, safety and productivity.

# Gauge options for optimal handling

We provide you with different table- and back gauge systems that are best suited to your requirements. Sheet handling that is ergonomic for the operator and gentle to the material.



U-gauge with balls in the table for better sheet handling



With the optional suction gauge all bends on one side can be done with one simple move by the operator

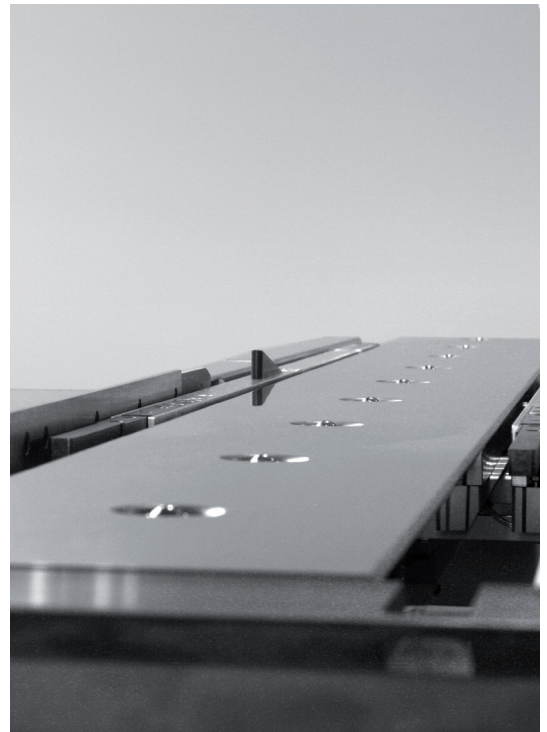

Pneumatic pop up square arms assembled aisle side and gauge fingers ensure a precise positioning of the sheet.

In the standard version the PowerBend Professional offers a sheet support system with a gauge from 10 to 1600 mm. Two sectors are pneumatically lowerable. In order to be able to bend slim sheets exactly at a right angle, you can optionally acquire two fixed square arms on the left and right side.

In addition you have the possibility to extend the back gauge to a J or U shape. The 1600 mm gauge forms the basis (see page 11).

## Exact positioning of the sheet

The motorized gauge of the PowerBend Professional ensures highest precision: It uses high precision ball screws to an accuracy of  $\pm 0,1$  mm. An interesting and extremely efficient alternative of positioning a sheet, is the option of using the folding beam as a front

gauge feature. This allows you to measure the part that needs to be bend.

## Option: Gauge with suction plates

The PowerBend Professional is the only machine in its class that now also offers a pneumatic fixing of sheets as complement to the back gauge system:

Plates with suction cups: The suction gauge takes effect where the pop-up gauge fingers have no reliable grip if the work piece on the gauge side e.g. has cut-outs or roundings. One great advantage: The sheet gets pneumatically fixed and thanks to the intelligent software control all bends on one side can be carried out with one single manual action.

# Tools

Use the right tool for the job – Schröder understands this better than anyone. With high-quality tools from Schröder you are able to fold exactly and to bend radii with highest precision.



Segmented tools





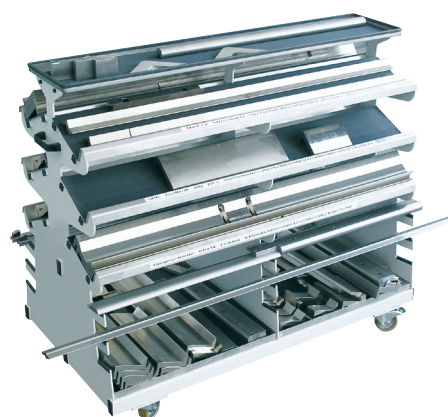

The hydraulic tool clamping device on the clamping beam reduces set-up times.

When it comes to the bending process the right tool is essential – with the PowerBend Professional we can push all limits. For every product we can offer you the suitable tool for the clamping-, bottom- and the folding beam. Should you require a particular geometry, just let us know. We will work out a customized solution for you.

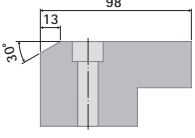
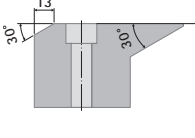
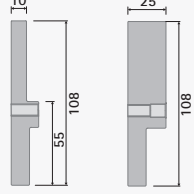

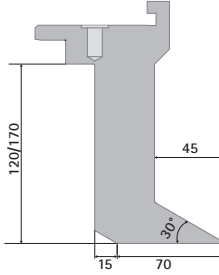
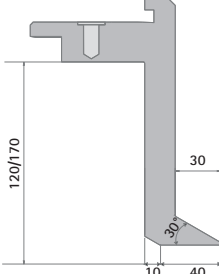
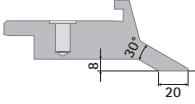
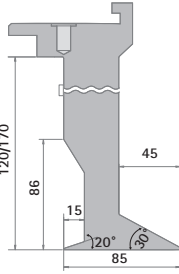
Always tidy: Use our practical tool cart for blades, rails and segmented tools as optional equipment.

Tool options			
<p>Bottom beam tools WZS* 16000/16100</p>		<p>Bottom beam blade, one piece, 55 mm high, minimum gauge dimension 10 mm, with finger grooves, hardened ca. 1 100 N/mm<sup>2</sup></p> <p>Bottom beam blade, segmented, 55 mm high, minimum gauge dimension 10 mm, with finger grooves, hardened ca. 1 100 N/mm<sup>2</sup></p>	 <p><b>Up and Down Bottom beam blade,</b> one piece, 55 mm high, 30°, R 1/1.5/3, minimum gauge dimension 10 mm (with finger grooves) hardened ca. 1 100 N/mm<sup>2</sup></p>
<p>Folding beam tools, pneumatic clamping WZS 15100</p>		<p>Segmented rail 10/15/20/25 mm, 108 mm high, ca. 700 N/mm<sup>2</sup> or hardened ca. 1 100 N/mm<sup>2</sup></p>	<p>With the Up and Down bi-directional bending for every folding blade width, one set of locking plates is required.</p>
<p>Clamping beam tools, hydraulic clamping, ca. 1 100 N/mm<sup>2</sup> surface-hardened WZS 2000</p>	   <p>Goat's foot blade 120 mm (s = 2.5 mm) or 170 mm (s = 2.0 mm) high, 20°/30°, R 1/1.5/3, clearance 30 mm, foot width 50 mm</p>	<p>Sharp nose blade 20°/30°, R 1/1.5/3, segmented</p> <p>Goat's foot blade 120 mm (s = 3.0 mm) or 170 mm (s = 2.5 mm) high, 20°/30°, R 1/1.5/3, clearance 45 mm, foot width 85 mm</p>    <p>Example: segmentation of folding blades at a working length of 2,040 mm (segmentation varies according to working length)</p>  <p>Example: segmentation of goat's foot tool at a working length of 2,040 mm (segmentation varies according to working length)</p>	<p>Tinsmith blade 20°/30°, R 1/1.5/3, clearance on the rear 8 mm, foot width 20 mm, segmented, s = 2.0 mm</p> <p>Goat's foot blade with heel 120 mm (s = 3.0 mm) or 170 mm (s = 2.5 mm) high, 30°, R 1/1.5/3, clearance 45 mm, foot width 85 mm</p>

\* WZS = Tool system

# POS 2000 Professional

Intelligent graphic control for efficient processing

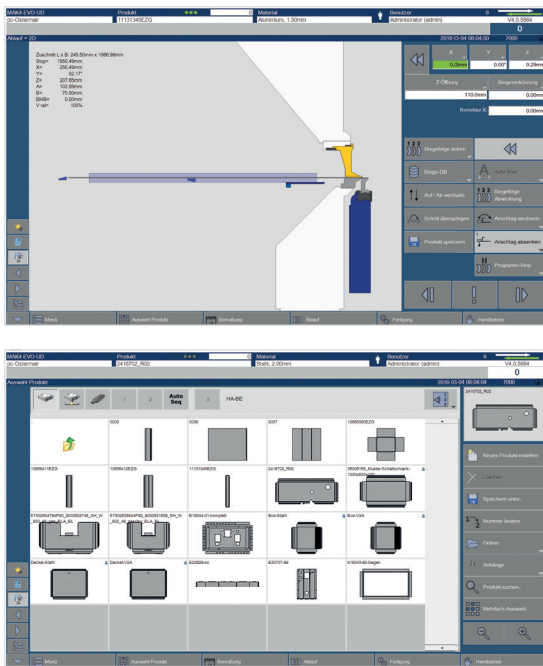

Graphic control POS 2000 Professional:  
the result always in front of your eyes - from the first steps to simulation

The PowerBend Professional owes its high processing speed, precision and efficiency to the powerful software control POS 2000 Professional control with touchscreen mounted on a swivelling arm. This software is known in the industry as „the“ software control for folding machines - proven and fully developed .

The POS 2000 Professional visualizes every processing step - through it, the folding machine, work piece and tools are schematically shown. The product is confirmed in a virtual mode prior to putting the sheet on the back gauge table, so the operator can form the part with 100% confidence. All necessary actions such as turning a sheet are displayed in separate steps.

In short: Whether programming, running a simulation for a feasibility check or time study, or manipulating a part on the machine, the POS 2000 Professional supports your operation like no other can.



## Highlights

- Windows 7 operating system
- Unlimited profile storage
- Automatic cut length calculation
- Unlimited tool storage and materials library
- Accurately scaled virtual bending simulation
- Zoom function
- Speed of CNC-axes infinitely variable

## Options

- Radius-Step-Bending function
- External programming (POS 2000 Professional PC version)
- Remote maintenance
- Positioning against the folding beam



# POS 3000 3D-graphic control

Visualize quality: POS 3000 3D-graphic control with simulation



The easy to understand graphics present a clear visual interaction between the part, the machine and the tools. Sophisticated parts are easily understood.

The POS 3000 software control allows you to import DXF, BPX and GEO-files. Hence the most important product- and folding parameters can be imported automatically and without any intervention of the operator. Using this function, all shapes of a sheet can get displayed and the operator can choose between additional gauge options. This means substantial time savings and has the additional advantage that the operator does not have to program the workpiece that has to be bend.

With the POS 3000 software, the machine, tool, and work piece are all clearly displayed. The operator bends the part visually beforehand on the screen and checks the result in the 3D bending simulator. This ensures a perfect processing of the sheet. Once a bending program has been created they can be called up again quickly, checked visually, and corrected according to material requirements.



## Highlights

- 3D-graphic control incl. schematic depiction of the machine, tools and work piece
- Intuitive, visual touchscreen-programming
- 3D-bending simulator for visual program inspection
- Cycle time calculator
- Radius-Step-Bending function
- External programming (POS 3000 PC version)
- CAM-connection
- ERP/PPS-interfaces
- DXF, BPX and GEO-import
- Remote maintenance

# Dimensions and technical data

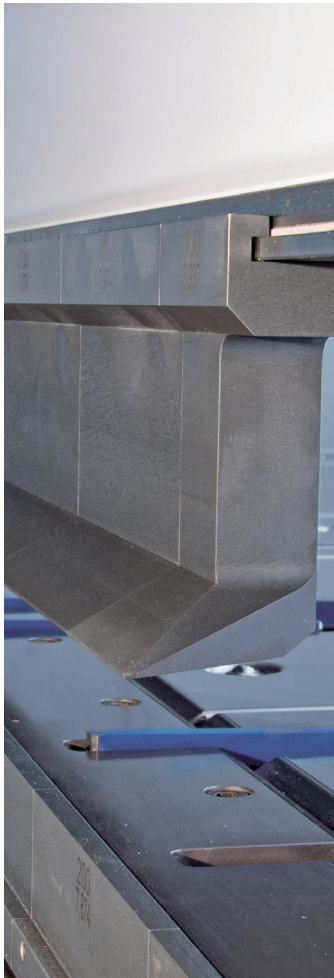

PowerBend Professional	2,000 × 4.0	2,500 × 4.0	3,200 × 3.0	4,000 × 2.5
Working length (a)	2,040 mm	2,540 mm	3,240 mm	4,040 mm
Sheet thickness 400 N/mm <sup>2</sup>	4.0 mm	4.0 mm	3.0 mm	2.5 mm
Machine length (b)	3,814 mm	4,314 mm	5,014 mm	5,814 mm
Machine height with swivelling arm	2,145 mm			
Machine height with rotating clamping beam	1,962 mm			
Machine height with rotating clamping beam & max. travel distance	2,312 mm			
Machine width with back gauge (c)				
1 600 mm closed table	2,573 mm			
U-1600	2,573 mm			
U-2400	-	3,446	-	-
U or rather J-3200	-	-	4,305	-
U or rather J-4000	-	-	-	5,093
Weight of basic machine (ca.)	5,100 kg	5,700 kg	6 500 kg	7,400 kg
Weight of machine with rotating clamping beam (ca.)	5,800 kg	6,500 kg	7,500 kg	8,500 kg
<b>Clamping beam</b>				
Geometry	48° (180°)	48° (180°)	48° (180°)	48° (180°)
Stroke	350 mm	350 mm	350 mm	350 mm
Drive power	3 kW/2 x 2.2 kW	3 kW/2 x 2.2 kW	3 kW/2 x 2.2 kW	3 kW/2 x 2.2 kW
Speed	20/65 mm/s	20/65 mm/s	20/65 mm/s	20/65 mm/s
<b>Folding beam</b>				
Drive power	2 x 2.2 kW/2 x 3.0 kW	2 x 2.2 kW/2 x 3.0 kW	2 x 2.2 kW/2 x 3.0 kW	2 x 2.2 kW/2 x 3.0 kW
Speed	85/105 °/s	85/105 °/s	85/105 °/s	85/105 °/s
Adjustment, motorized	80 (160) mm	80 (160) mm	80 (160) mm	80 (160) mm
Folding centre adjustment-	± 20 mm	± 20 mm	± 20 mm	± 20 mm

Segmented goat's foot blade, hydraulic tool clamping

All specifications are considered as guidelines and may be subject to changes at any time.  
\* Differing specifications for the Up-and-Down function are in brackets.

## Dimensions: PowerBend Professional

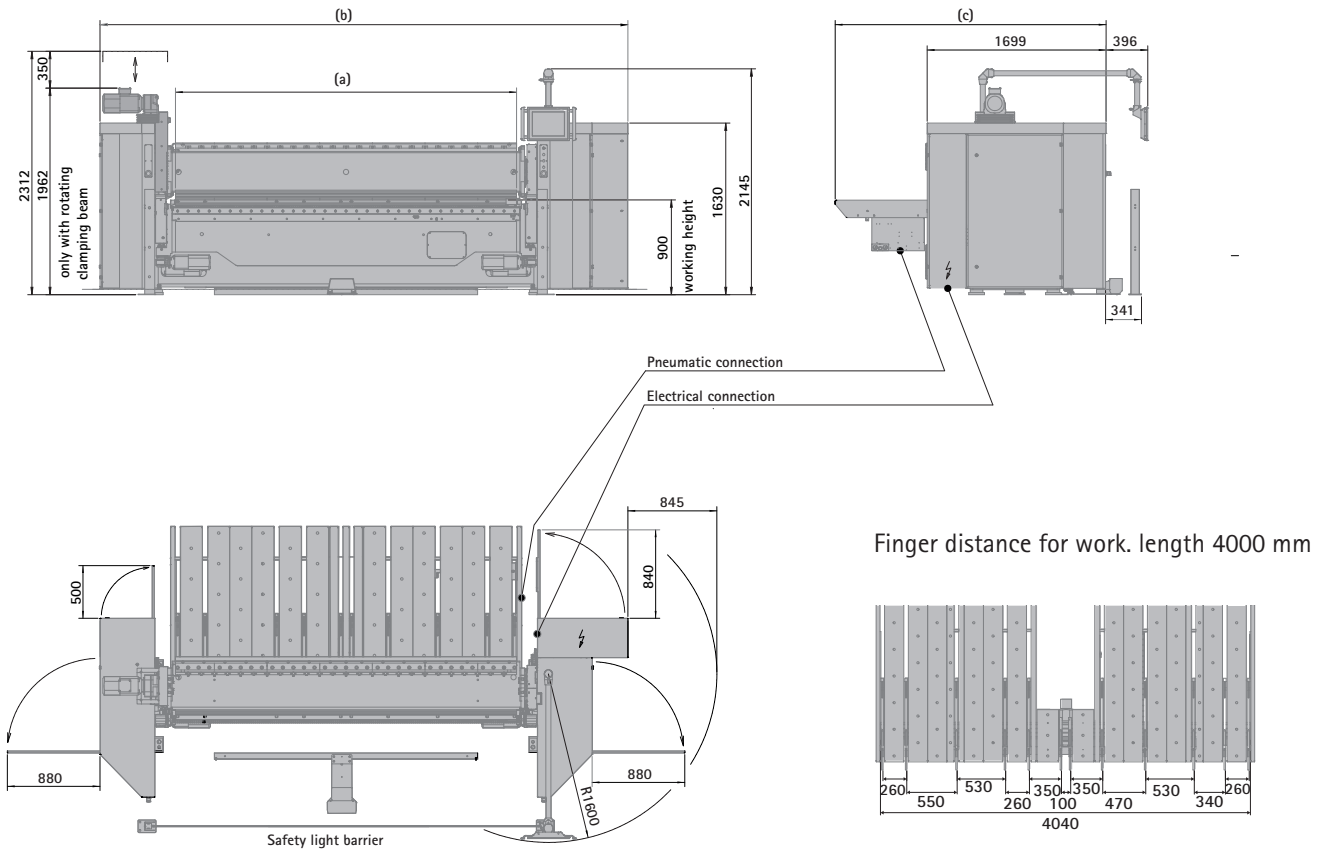

## Special back gauge extensions

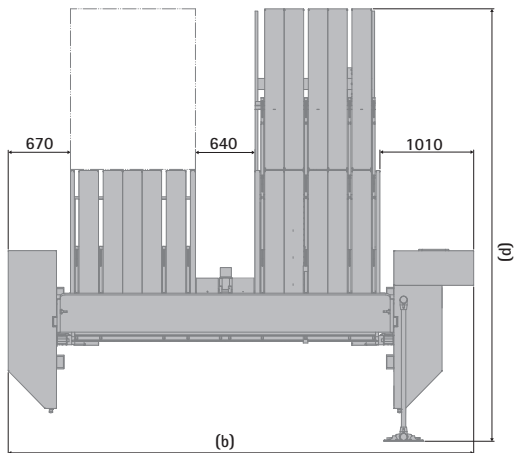

J-shape 3 200/1 600, 4 x 800 mm  
 J-shape 4 000/1 600, 5 x 800 mm

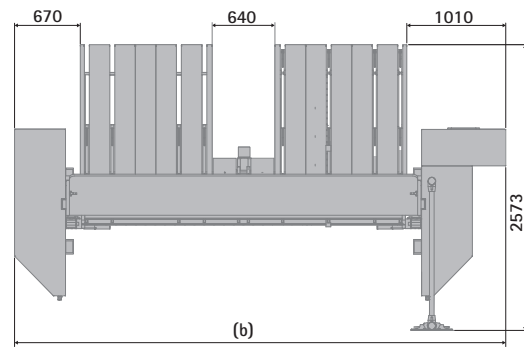

U-shape 1 600, 2 x 800 mm  
 U-shape 2 400, 3 x 800 mm  
 U-shape 3 200, 4 x 800 mm  
 U-shape 4 000, 5 x 800 mm

All dimensions in mm; Standard colour: RAL 7035 light grey, RAL 5003 sapphire blue. Special painting at an extra charge



## Schröder Group

The Schröder Group consists of Hans Schröder Maschinenbau GmbH, which is located in Wessobrunn, Germany, and SCHRÖDER-FASTI Technologie GmbH, which is located in Wermelskirchen, Germany.

Founded in 1949, Hans Schröder Maschinenbau GmbH unifies traditional and modern approaches in machine building: Successfully managed as a quality and customer-oriented, family-owned company, Hans Schröder Maschinenbau is specialized in the development of modern machine concepts for bending and cutting sheet metal.

The successful integration of the Fasti Company in 2006 and its worldwide presence make the Schröder Group one of today's leading providers of machines for bending, cutting, beading, flanging, and circular bending all types of sheet metal. The company's precision machines range from proven solutions for craftsmen to innovative, high-performance machines for automatic industrial production processes. Overall, the Schröder Group currently employs more than 240 people at various locations at home and abroad.

All information provided as a guide only  
and subject to change at all times.  
HSM 160330EN

**Hans Schröder Maschinenbau GmbH**  
Feuchten 2 | 82405 Wessobrunn-Forst | Germany  
T +49 8809 9220-0 | F +49 8809 9220-700  
E [info@schroedergroup.eu](mailto:info@schroedergroup.eu)  
[www.schroedergroup.eu](http://www.schroedergroup.eu)

**SCHRÖDER**  
GROUP