

PRODUKTKATALOG

2017



A-Supply



A-Supply A/S

Hus & Have grossist



Prisliste 2017

Side Indholdsfortegnelse

2	Forside	36	Træpilleovne
3	Herregårdssten	37	Træpilleovne
4	Herregårdssten	38	Træpilleovne
5	Herregårds cirkelsten/palisadesten	39	Tilbehør
6	Herregårdsblokke/belægningssten	40	Tilbehør
7	Havefliser	41	Salt
8	Støttemursten	42	Stål, kamstål
9	Trapper	43	Stål, net
10	Funda-/lecablokke	44	Stål, kamstål, net, bjælker
11	Murbjælker	45	Stål, bjælker, div.
12	Overligger	46	Stål, div.
13	Sålbænke/murafdækninger	47	Fragt, tillæg, pallegebyr mm.
14	Skagen luksus fliser		
15	Granit, chaussésten		
16	Granit, chaussésten, mosaiksten		
17	Granit, kantsten		
18	Granit, kantsten radius		
19	Granit, fliser, bordursten		
20	Granit, fliser, trædesten, trapptrin		
21	Granit, diverse		
22	Fliserens/-imprægnering, gulvprod.		
23	Bigbags 0,5m ³		
24	Sække		
25	Bigbag 1000kg		
26	Aeroc, blokke, plader		
27	Aeroc, overligger		
28	Aeroc, overligger		
29	Aeroc, væg-/loftselementer		
30	Aeroc, diverse		
31	Flamingo		
32	Rullegræs		
33	Brænde		
34	Briketter, træpiller		
35	Brændeovne		



HERREGÅRDSSTEN

Farve	Modulmål	Antal pr palle	Vægt	Vare-	Salgspris
	inkl. 2 mm fuge	m ²	pr. m ²	nummer	pr. m ²

HERREGÅRDSS 34 stk. pr. m²

m. presset kant

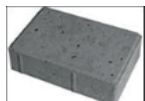

Grå	14x21x6	10,58	135	4860	74,95
GråMix	14x21x6	10,58	135	4860 GM	84,00
Sort/Antrazi	14x21x6	10,58	135	4860 S	95,00
Rød	14x21x6	10,58	135	4860 R	95,00
RødMix	14x21x6	10,58	135	4860 RM	95,00

HERREGÅRDSS

m. presset kant

"halve sten"

Grå	14x10,5x6	10,58	135	141056PG	2,15
Sort/Antrz	14x10,5x6	10,58	135	141056PS	2,51

HERREGÅRDSS 34 stk. pr. m²

m. skarp kant

Grå	14x21x6	10,58	135	4865	74,95
GråMix	14x21x6	10,58	135	4865 GM	84,00
Sort/Antrazi	14x21x6	10,58	135	4865 S	95,00

HERREGÅRDSS 34 stk. pr. m²

m. slået kant



Grå	14x21x6	10,58	135	4870	79,95
Gråmix	14x21x6	10,58	135	4870 GM	90,00
Sort/Antrazi	14x21x6	10,58	135	4870 S	99,00

HERREGÅRDSS 34 stk. pr. m²

m. skarp kant

obs. 7 cm lev fra sjælland

Grå	14x21x7	9,4	153	14217	85,40
GråMix	14x21x7	9,4	153	14217GM	95,95
Sort/Antrazi	14x21x7	9,4	153	14217S	105,00

m. slået kant

obs. 7 cm lev fra sjælland

Grå	14x21x7	9,4	153	14217GS	92,95
GråMix	14x21x7	9,4	153	14217GMS	102,95
Sort/Antrazi t	14x21x7	9,4	153	14217SS	117,95



Farve	Modulmål	Antal pr palle	Vægt	Vare-	Salgspris
	inkl. 2 mm fuger	m ²	pr. m ²	nummer	pr. m ²

34 stk. pr. m²

HERREGÅRDSSTEN

m. slået kant (tromlet)



m.skarp kant

Grå	14x21x5,5	11,47	125	142155 T	74,95
Gråmix	14x21x5,5	11,47	125	142155 TGM	84,95
Sort/Antrazit	14x21x5,5	11,47	125	142155 TS	97,00

Grå	14x21x5,5	11,76	125	3142155	70,00
Gråmix	14x21x5,5	11,76	125	3142155GM	80,00
Sort/Antrazit	14x21x5,5	11,76	125	3142155S	89,00

HERREGÅRDSSTEN

M/Faset kant



34 stk. pr. m²

Grå	14x21x4	17,65	80	4840	59,95
-----	---------	-------	----	------	--------------

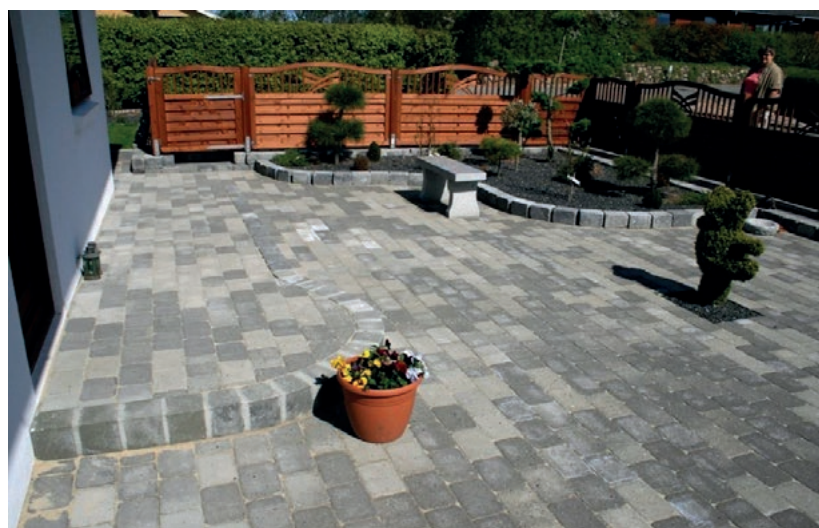

CIRKEL-HERREGÅRDSSTEN

Farve	Modulmål	Antal pr palle	Vægt	Vare-	Salgspris
	inkl. 2 mm fuge	Stk.	stk	nummer	pr. stk.

CENTER-sten hele

Presset kant



Grå	Ø28 x 6	100	8,5	48600	30
Gråmix	Ø28 x 6	100	8,5	48600 GM	31
Sort/Antrazit	Ø28 x 6	100	8,5	48600 S	32

Slået Kant (Tromlet)

Grå	Ø28 x 6	100	8,5	48700	32
Gråmix	Ø28 x 6	100	8,5	48700 GM	33
Sort/Antrazit	Ø28 x 6	100	8,5	48700 S	35

LILLE-cirkesten

Presset kant



Grå	14 x 10 x 6	480	1,5	48601	3
Gråmix	14 x 10 x 6	480	1,5	48601 GM	3,2
Sort/Antrazit	14 x 10 x 6	480	1,5	48601 R	3,5

Slået Kant (Tromlet)

Grå	14 x 10 x 6	480	1,5	48701	3,2
Gråmix	14 x 10 x 6	480	1,5	48701 GM	3,5
Sort/Antrazit	14 x 10 x 6	480	1,5	48701 R	3,9

STOR-cirkesten

Presset kant



Grå	14 x 14 x 6	480	2,3	48602	3
Gråmix	14 x 14 x 6	480	2,3	48602 GM	3,2
Sort/Antrazit	14 x 14 x 6	480	2,3	48602 S	3,5

Slået Kant (Tromlet)

Grå	14 x 14 x 6	480	2,3	48702	3,2
Gråmix	14 x 14 x 6	480	2,3	48702 GM	3,5
Sort/Antrazit	14 x 14 x 6	480	2,3	48702 S	3,9

PALISADESTEN

Presset kant



Grå	14 x 14 x 20	168	7,2	48603	25
Gråmix	14 x 14 x 20	168	7,2	48603 GM	27
Sort/Antrazit	14 x 14 x 20	168	7,2	48603 R	30

Slået Kant (Tromlet)

Grå	14 x 14 x 20	168	7,2	48703	27
Gråmix	14 x 14 x 20	168	7,2	48703 GM	29
Sort/Antrazit	14 x 14 x 20	168	7,2	48703 R	32

HERREGÅRDSBLOKKE

Farve	Modulmål	Antal m ²	Antal palle	Vægt	Salgspris pr. stk.	Salgspris pr. m ²
	inkl. 2 mm fuge	Stk.	Stk.	Stk.		

HERREGÅRDSBLOKKE

m. Skarp kant



Grå	14 x 14 x 21	34	144	9	8	272
Gråmix	14 x 14 x 21	34	144	9	9	306
Sort/Antrazit	14 x 14 x 21	34	144	9	10	340

m. Slået kant (tromlet)



Grå	14 x 14 x 21	34	150	9	9	306
Gråmix	14 x 14 x 21	34	150	9	10	340
Sort/Antrazit	14 x 14 x 21	34	150	9	11	374

HAVEKANTSTEN



Farve	Modulmål	Antal /palle	Vægt	Salgspris pr. stk.	Salgspris pr. m ²
Grå	50 x 25 x 5	80	14,4	22,50	

BELÆGNINGSSTEN

Farve	Modulmål	Antal m ²	Vægt	Vare-	Salgspris pr. stk.	Salgspris pr. m ²
	inkl. 2 mm fuge	Pr. Palle	pr. m ²	nummer		

I-STEN



40 stk. pr. m²

Grå	20 x 12,5 x 6	10	140	4160		67,82
-----	---------------	----	-----	------	--	-------

S-STEN



49 stk. pr. m²

Grå	19 x 10,5 x 6	10,2	140	4360		81,39
Grå randsten	21,2x22x6		132	4360R		124,15
Grå slutsten	19x9,5x6		132	4360S		124,15
Grå	19 x 10,5 x 8	8,2	175	4380		90,27

HOLLÆNDERSTEN

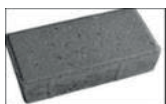

50 stk. pr. m²

Grå	20 x 10 x 7	9	160	4270		81,39
Sort/antrazit	20 x 10 x 7	9	160	4270RM		101,74

KLØVERSTEN



36 stk. pr. m²

Grå	17,5 x 15 x 6	10	140	4060		81,39
Grå	17,5 x 15 x 8	8	180	4080		75,22

MASKINSTEN/ CoLocsten



Grå	7	8		4060C		75,00
Grå	9	8		4061C		75,00

HAVEFLISER

Farve	Modulmål inkl. 3 mm fuge	Antal pr. m ²	Antal pr. palle Stk.	Vægt Stk.	Vare- nummer	Pris pr. stk.	Pris pr. m ²
-------	--------------------------------	-----------------------------	----------------------------	--------------	-----------------	------------------	----------------------------

HAVEFLISER

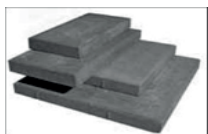

Grå	60 x 60 x 6	2,78	24	49	5060606	32,75	91,05
Sort/Antraz	60 x 60 x 6	2,78	24	49	5060606 S	40,28	112,00
Grå	60 x 30 x 6	5,56	60	24	5060306	16,25	90,35
Sort/Antraz	60 x 30 x 6	5,56	60	24	5060306 S	20,50	113,98
Grå	50 x 50 x 5	4	40	28	5050505	19,80	79,20
Sort/Antraz	50 x 50 x 5	4	40	28	5050505 S	24,80	99,20
Grå	50 x 25 x 5	8	80	14	5050255	12,10	96,80
Sort/Antraz	50 x 25 x 5	8	80	14	5050255 S	14,60	116,80
Grå	40 x 40 x 7	6,25	48	25	5040407	16,32	102,00
Sort/Antr	40 x 40 x 7	6,25	48	25	5040407S	19,68	123,00
Grå	40 x 40 x 5	6,25	60	17	5040405	13,00	81,25
Sort/Antraz	40 x 40 x 5	6,25	60	17	5040405 S	16,90	105,65
Grå	40 x 20 x 5	12,5	120	8	5040205	8,90	111,25
Sort/Antraz	40 x 20 x 5	12,5	120	8	5040205 S	10,56	132,00
Grå	30 x 30 x 6	11,11	120	12	5030306	8,00	88,88
Sort/Antraz	30 x 30 x 6	11,11	120	12	503030 S	10,00	111,10
Grå	30 x 30 x 4	11,11	180	7,5	5030304	5,76	64,00
Sort/Antra	30 x 30 x 4	11,11	180	7,5	5030304s	7,56	84,00

SKIFERPRÆG



Grå	30 x 30 x 6	11,11	120	12	5030306 SP	9,00	99,90
Sort/antrazi	30 x 30 x 6	11,11	120	12	5030306 sps	11,00	122,10

SLOTS-FLISER



Grå	50 x 50 x 6	4	40	33	5050506 S	26,25	105,00
-----	-------------	---	----	----	-----------	-------	--------

Kopper

Grå	10 x 10 x 6	100	800	1,35	4210106	1,50	150,00
Sort/Antraz	10 x 10 x 6	100	800	1,35	4210106 S	2,60	260,00
Rød	10 x 10 x 6	100	800	1,35	4210106R	2,60	260,00



STØTTEMUR



	Modulmål	Antal	Antal pr. palle	Vægt	Vare-	Pris
	inkl. 2 mm fuge	pr. m ²	Stk.	Stk.	nummer	pr. stk.

ROMERBLOK

Klippet og
glat facade

Grå	50 x 20 x 16	12,50	40	36	54502016	36,00
Sort/Antrazit	50 x 20 x 16	12,50	40	36	54502016S	44,00
Grå endestk.	40 x 20 x 16		40	30	54402016	79,00
Sort endestk.	40 x 20 x 16		40	30	54402016S	86,50

Tromlet
Tromlet

Grå	50x 20 x 16	12,50	40	36	54502016T	40,00
Sort/Antrazit	50x 20 x 16	12,50	40	36	54502016TS	48,00

MEGA-BLOK

Skarp kant
Skarp kant

Grå	42 x 21 x 14	11,3/ 17	54	27	48654221	29,95
Sort/Antrazit	42 x 21 x 14	11,3/ 17	54	27	48654221S	34,95

Tromlet
Tromlet

Grå	42 x 21 x 14	11,3/ 17	54	27	48704221T	34,95
Sort/Antrazit	42 x 21 x 14	11,3/ 17	54	27	48704221TS	39,95

MAXI-BLOK

Skarp kant/klippet
Skarp kant/klippet

Grå	21 x 21 x 14	22,7/ 34	108	13	48652121	19,95
Sort/Antrazit	21 x 21 x 14	22,7/ 34	108	13	48652121 S	22,95

Tromlet
Tromlet

Grå	21 x 21 x 14	22,7/ 34	108	13	48702121T	22,95
Sort/Antrazit	21 x 21 x 14	22,7/ 34	108	13	48702121TS	24,95

KNÆKFILSER



Hjørner .

Grå	55 x 40 x 7	13,00	40	26	5455407	22,00
Grå	55 x 40 x 7	13,00	40	26	5455407H	33,00

AC STØTTEMURSTEN



Grå	50 x 25 x 14	14,00	64	20	54502514	18,00
Sort/Antrazit	50 x 25 x 14	14,00	64	20	54502514 S	23,00

TRÆDEFLISER



Grå	Ø 50x40 x 5		40	20	5050405	30,00
BrunMix	Ø 50x40 x 5		40	20	5050405 BM	30,00

Trapper: Ab værk priser – se fragt



Farve	Dimension	Antal pr. palle	Vægt	Vare-nummer	Salgspris
		Stk.	Stk.		stk.

TRAPPETRIN:



efter aftale

Grå beton	50x50x14	20	75	51505014	90,00
Grå beton	50x35x14	24	52	51503514	61,00
Grå beton	50x35x18	18	68	51503518	102,50

FRILAGT TRIN

Længde . 75– 150 cm ..



Fremstilles efter aftale

Røde Søsten	100x35x16	6	129	5110016FR	540
Hvid Granit	100x35x16	6	129	5110016FH	540
Grå Granit	100x35x16	6	129	5110016FG	540
Sort granit	100x35x16	6	129	5110016FS	540

SKRÅ FORKANT:

18 & 20cm eft. ordre.



efter aftale

Grå beton	100x40x14	10	128	5110014SF	235
Grå beton	50x40x14	20	64	515014SF	150

Grå beton	100x40x16	10	128	5110014SF	235
Grå beton	50x40x16	20	64	515014SF	150

CIRKEL TRIN:



Fremstilles efter aftale

Frilagt .	Røde Søsten	Ø 100 x 14	1	126	5110014 FR	900
Frilagt .	Hvid Granit	Ø 100 x 14	1	126	5110014 FH	900
Frilagt .	Grå Granit	Ø 100 x 14	1	126	5110014 FG	900
Frilagt .	Sort granit	Ø 100 x 14	1	126	5110014 FS	900

Frilagt .	Røde Søsten	Ø 130 x 14	1	280	5115014 FR	1440
Frilagt .	Grå Granit	Ø 130 x 14	1	280	5115014 FG	1440
Frilagt .	Sort granit	Ø 130 x 14	1	280	5115014 FS	1440

Frilagt .	Røde Søsten	Ø 200 x 14	1	500	5120014 FR	2400
Frilagt .	Grå Granit	Ø 200 x 14	1	500	5120014 FG	2400
Frilagt .	Sort granit	Ø 200 x 14	1	500	5120014 FS	2400

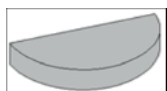

Grå beton	Ø 100 x 14	1	126	5110014	618
Grå beton	Ø 130 x 14	1	280	5115014	870
Grå beton	Ø 200 x 14	1	500	5120014	1980

FUNDAMENT-BLOKKE

Priser er ekskl. moms, ab værck - se fragt

10 stk/m ²	Dimension	Vægt	antal	udfyldn.	Vare-	Salgspris pr. stk.
		pr blok	pr. palle	l /pr blok	nummer	

FUNDA



Cement mursten .

	15 x 20 x 50	17,8	72	8 ltr.	320152050	8,15
	19 x 20 x 50	21	60	10 ltr	320192050	8,70
	23 x 20 x 50	23	48	13 ltr	320232050	9,48
	29 x 20 x 50	26	36	19 ltr	3292050	10,11
	33 x 20 x 50	24	36	23 ltr	320332050	11,07
	39 x 20 x 50	20	24	29 ltr	320392050	16,10
	5,5 x 11 x 23	2,9	512		320051123	dagspris

LECA® BLOKKE



LECA® mursten .

10 stk/m ²	Dimension	Vægt	antal	vægt	Vare-	
		pr blok	pr. palle	pr. palle	nummer	
	5 x 19 x 49	2,9	192	557	3051949	10,31
	7,5x 19 x 49	4,4	144	634	3071949	12,78
	10 x 19 x 49	5,8	108	626	3101949	8,66
	15 x 19 x 49	8,7	72	626	3151949	13,61
	19 x 19 x 49	11,5	60	690	3191949	17,33
	23 x 19 x 49	14	48	672	3231949	21,03
	29 x 19 x 49	18	36	648	3291949	26,73
	33 x 19 x 49	20	36	720	3331949	29,70
	35 x 19 x 49	22	36	792	3351949	31,35
	39 x 19 x 25	12,3	72	886	3391949	37,95
						0,00
	5,5 x 11 x 23	1,2	640	768	3051123	2,48

LECA®TERMO-BLOKKE

Flexhjørne .

	33 x 19 x 49	17	36	612	3331949LT	51,15
	35 x 19 x 49	18	36	648	3351949LT	54,45
	39 x 19 x 49	20,5	36	738	3391949LT	57,33
	45 x 19 x 49	21	24	504	3451949LT	70,95
	19 x 25	9	60	540	3391525H	30,75

HVÆLVNINGE-PLADER

	98 x 50 x 10	35	20	700	3101005010	183,60
--	--------------	----	----	-----	------------	---------------

LECA®-BETON - MURBJÆLKER

Godkendte

Længde cm	124	149	199	249	299	349	399	449	499	vare- nummer
bredde x højde	Pris pr. stk. ab værk - se fragt									
10 x 19	342,72	442,53	599,76	749,70	899,64	1103,13	1240,53	1477,98	1649,34	3101019+L
15 x 19	466,65	553,53	749,70	931,77	1124,55	1377,00	1545,03	1852,83	2062,44	3101519+L
19 x 19	524,79	616,53	835,38	1044,99	1253,07	1531,53	1723,53	2067,03	2302,65	3101919+L
23 x 19	616,59	726,03	985,32	1231,65	1477,98	1809,99	2034,03	2441,88	2709,63	3102319+L
29 x 19	738,99	868,53	1178,10	1473,39	1767,15	2163,42	2427,03	2919,24	3245,13	3102919+L
33 x 19	884,34	1041,03	1413,72	1767,15	2120,58	2597,94	2916,03	3534,30	3930,57	3103319+L
39 x 19	1263,78	1492,53	2024,19	2538,27	3052,35	3737,79	4201,53	5033,70	5622,75	3103919+L

BETON -

TØRSTØBT-RUSTIK

MURBJÆLKER

produceres efter mål

Længde cm		<150	<200		<300		<400		<500	vare- nummer
bredde x højde	Pris pr.stk. ab værk - se fragt									
10 x19		670,14	844,56		1124,55		1580,49		2062,44	3241019+L
15 x 19		810,90	991,44		1406,07		1967,58		2578,05	3241519+L
19 x19		890,46	1098,54		1566,72		2195,55		2877,93	3241919+L
23 x19		1031,22	1285,20		1848,24		2590,29		3387,42	3242319+L
29 x19		1211,76	1526,94		2209,32		3092,13		4056,03	3242919+L
33 x19		1432,08	1820,70		2651,49		3714,84		4912,83	3243319+L
39 x19		1901,79	2530,62		3815,82		5355,00		7028,82	3243919+L

BETON -

BLØDSTØBT - GLAT

MURBJÆLKER

produceres efter mål

Længde cm		<150	<200		<300		<400		<500	vare- nummer
bredde x højde	Pris pr. stk. Ab værk - se fragt									
10 x19		810,90	991,44		1406,07		1973,70		2578,05	3291019+L
15 x 19		985,32	1224,00		1756,44		2460,24		3220,65	3291519+L
19 x19		1086,30	1358,64		1956,87		2744,82		3595,50	3291919+L
23 x19		1254,60	1592,73		2203,20		3237,48		4233,51	3292319+L
29 x19		1487,16	1894,14		2760,12		3864,78		5070,42	3292919+L
33 x19		1764,09	2262,87		3255,84		4643,55		6141,42	3293319+L
39 x19		2376,09	3162,51		4769,01		6693,75		8785,26	3293919+L



BETON-OVERLIGGERE

Længde cm	110	130	-		160		200		vare- nummer
bredde x højde	Pris pr. stk. ab lager - se fragt								
10 x 5	94,86	107,1	-				-	-	324105+L
10 x 10	-	-	-		171,36		246,33		3241010+L

BETON- / MURSTENSOVERLIGGERE

antal mursten	-	5	6		8		10	-	vare- nummer
Længde cm	-	119	143		191		239	-	325115 + antal sten
bredde x højde	Pris pr. stk. ab lager - se fragt								
11 x 5	-	96,39	116,28		154,53		192,78	-	

ARMERED E - BETONOVERLIGGERE

Blødstøbt Produceres efter ordre FORH 20%

Længde cm	100		150		200	250	300	400	vare- nummer
bredde x højde	Pris pr. stk. ab lager - se fragt								
11 x 12	244,8		581,4		680,85	703,8	826,2	1009,8	3241112+L

BETON MURBJÆLKER TIL PORE-/GASBETON

Pris pr. stk. ab lager - se fragt

Bredde x højde	længde	Lysvidde CM	Bæreevne kN/m	Vægt	Salgspris	Vare- nummer
10x19	149	121	30,0	68	800	3291019150
10x19	179	151	31,8	82	900	3291019180
10x19	213	193	15,0	96	1200	3291019213
10x19	239	181	15,3	109	1300	3291019239
10x26	239	181	30,0	149	1600	3291026239
10x26	299	241	20,0	187	2100	3291026299
10x26	360	241	26,2	225	2400	3291026360
15x26	211	181	36,0	197	2200	3291526211
15x26	250	222	42,0	234	2700	3291526250
15x26	299	263	23,0	280	3200	3291526299
15x26	345	241	29,9	323	3500	3291526345
15x26	360	324	12,4	337	3900	3291526360
21x26	330	241	31,0	432	4000	3292126330
25x26	330	294	20,1	432	4200	3292526330







SÅLBÆNKE

blødstøbt (glat overflade)

Prod. efter ordre

Længde cm			58,8	88,8	100	119	131	149	190	Antal pr. Palle	varenummer
	Bredde	Højde									

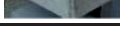
antal skift.			Pris pr. stk ab lager - se fragt								Antal pr. Palle	varenummer
	1	15	3,5/5,5	275	257	269	318	352	402	589		
	1	15	2,5/5,5	275	257	269	318	352	402	589	12	323115 + L
	2	15	10x12	367	379	416	496	545	621	791	12	323215 + L
	1	20	3,5/5,5	306	318	330	395	588	494	629	12	323120 + L
	2	20	8x12	428	453	477	569	626	711	907	12	323120 + L
	2	22	7x11	490	514	539	588	649	710	759	12	323120 + L

ALMUE

	2	15	8x12	490	526	563	672	737	838	1071	12	3232 A + L
---	---	----	------	-----	-----	-----	-----	-----	-----	------	----	------------

MURAFDÆKNINGER

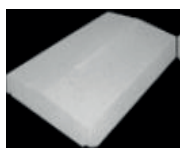

Murmål	Pris pr. stk. ab lager				
11 cm	18 x 5,0/3 x 60 cm	12 kg	117,00	80	3941860
23 cm	30 x 5,5/3 x 50 cm	15 kg	140,50	60	3943050
30 cm	36 x 5,5/3 x 50 cm	18 kg	148,24	60	3943650
35 cm	42 x 6,5/3 x 50 cm	23 kg	156,06	40	3944250

MURAFDÆKNINGER

blødstøbt (glat overflade)

Prod. efter ordre

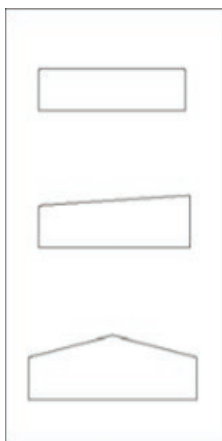

Pris pr. stk. ab lager					
Uden fald	34 x 12 x 100 cm	94 kg	447,00	4	3943412100
	39 x 8 x 100 cm	72 kg	342,00	4	394398100
	42 x 8 x 100 cm	77 kg	366,00	4	394428100
Fald til siden	30 x 9/10 x 100 cm	69 kg	366,00	4	39430910100
	35 x 8/10 x 100 cm	72 kg	494,00	4	39435810100
	41 x 7/9 x 100 cm	75 kg	366,00	4	3944179100
fald til begge sider	36 x 8/10 x 100 cm	75 kg	366,00	4	39436810100
	42 x 8/10 x 100 cm	87 kg	427,00	4	3 9442810100
	48 x 5/8 x 100 cm	72 kg	366,00	4	39448508100

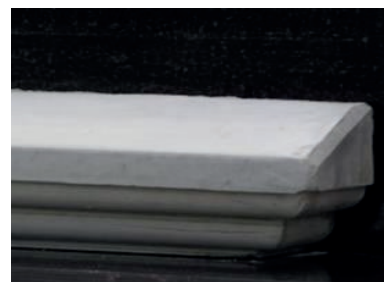



SKAGEN LUKSUS FLISER

Frit leveret v/5 hele paller, - se fragt

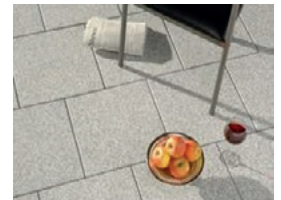

Skagen	Priser er ekskl. Moms						
Luksus fliser		Antal	Antal stk	Antal m ²	varenr.	Vejl. pris	Vejl. pris
		pr. m ²	pr. palle	pr. palle		pr. stk.	pr. m ²

Skagen Luxogran Flise

Farve							
Grå	40 x 40 x 4 cm	6,25	56	8,96	340404L045	39,68	248
Sortgrå	40 x 40 x 4 cm	6,25	56	8,96	340404L070	39,68	248
Salt og peper	40 x 40 x 4 cm	6,25	56	8,96	340404L033	39,68	248
Sort	40 x 40 x 4 cm	6,25	56	8,96	340404L703	39,68	248

Skagen Luxogran Struktur Overfladebehandlet

Grå struktur	60 x 40 x 4 cm	4,17	36	8,64	3604006664	69,8	293
--------------	----------------	------	----	------	------------	------	-----

Skagen Nanoline Nano overflade

Platin grå	60 x 40 x 4 cm	4,17	36	8,64	3604077064	77,77	327
Sort	60 x 40 x 4 cm	4,17	36	8,64	3604077364	77,77	327
Sandfarvet struk	60 x 40 x 4 cm	4,17	36	8,64	3604006764	77,77	327

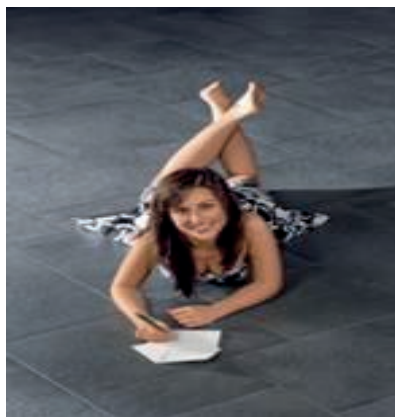

Granit, frit lev. v/5 paller, - se fragt

Chaussesten / Flækker, håndhugget granit

farve	navn		emb.			Varenr.	Salgspris
				m ² /ks.	stk/		Vejl.
					kasse		kr/m ²
grå	Kina 9 x 9 x 4/6 cm G603	m2	ks.	11,44	1144	1022600	349
blå	Kina 9 x 9 x 4/6 cm G654	m2	ks.	11,44	1144	1022602	364
rødgrå	Kina 9 x 9 x 4/6 cm G354	m2	ks.	10,00	1000	1022604	486
sortgrå	Kina 9 x 9 x 4/6 cm G685	m2	ks.	11,44	1144	1022606	364
lysgrå	Kina 9 x 9 x 8/10cm, G603	m2	ks.	6,16	616	1022620	507
blå	Kina 9 x 9 x 8/10 cm, G654	m2	ks.	6,16	616	1022622	607
rødgrå	Kina 9 x 9 x 8/10 cm, G354	m2	ks.	6,00	600	1022624	746
sortgrå	Kina 9 x 9 x 8/10 cm, G685	m2	ks.	6,16	616	1022626	593

ks. er ca. 1,1 tons



Granit

Chaussesten 8/11 cm

Leveres i bigbag med ca. 1,2t. Tillæg for bigbag+engangspalle.

farve	navn	enhed	emb.	ca.	ca.	Varenr.	Salgspris	
				m ² /tons	stk/m ²		Vejl.	
							kr/tons	
	grå	Porto	ton	løs	4,75	85	1022101	1524
	grå	Porto Fino 8/10 cm	ton	løs	5,00	100	1022107	1618
	mørkgrå	Roriz	ton	løs	4,75	85	1022112	1560
	mørkgrå	Roriz Fino 8/10 cm	ton	løs	5,00	100	1022110	1684
	sortrød	Svensk Halmstad	ton	løs	4,75	85	1022205	3228
	rødgrå	Kina Bohus G3554	ton	løs	4,75	85	1022401	2820
X	rød	India Manga	ton	løs	4,50	85	1022301	2233
X	mørkrød	India Magadi	ton	løs	4,50	85	1022310	2463
	sort	India Black	ton	løs	4,20	85	1022303	2432
X	gul	India Sunshine Yellow	ton	løs	4,50	85	1022305	2750
	diverse	Slidt nordiske granitter	ton	løs - fra:	4,75	85		3036

Brosten 14*20*14 cm (B2)

Leveres i bigbag med ca. 1,2t. Tillæg for bigbag+engangspalle.

farve	navn		emb.	ca.	ca.	Varenr.	Salgspris	
				m ² /tons	stk/m ²		Vejl.	
							kr/tons	
	grå	Porto	ton	løs	2,75	31	1042101	1524
	mørkgrå	Roriz	ton	løs	2,75	31	1042112	1560
	rød	Kina G354	ton	løs	3,00	31	1042401	2820
X	rød	India Manga	ton	løs	2,50	31	1042302	2233
	sort	India Black	ton	løs	2,20	31	1042304	2376
	diverse	Slidt nordiske granitter	ton	løs fra:	2,50	31		2409

Mosaiksten 4/6 cm

farve	navn		emb.	ca.m2	ca.	Varenr.	Salgspris	
				pl/ton	stk/m ²		Vejl.	
							kr/tons/m2	
	grå	Kina 6x6x4/6 G603	m2	ks	5,00	225	1503894	500
	blågrå	Kina 6x6x4/6 G654	m2	ks	5,00	225	1503890	551
	rød	Bohus	ton	ks.	10,00	300	1012202	2501
	rød	India Magadi/Manga	ton	ks.	10,00	300	1012301	2197
	sort	India Black	ton	ks.	8,00	300	1012304	2515

ks. er ca. 1,3 tons

X = bestillingsvare



Granit

Kantsten

farve	navn	enhed	emb.	lbm./ stk./		Varenr.	Vejl.
				pl.	pl.		
grå	Parkkantsten 8*20 x 80-140 cm, Porto	meter	palle	40,00		1062101	145
mørkgrå	Parkkantsten 8*20 x 80-140 cm, Roriz	meter	palle	40,00		1062103	151
lysgrå	Parkkantsten 7*20 x 50 cm, Kina G603	stk.			60	1062414	60
lysgrå	Parkkantsten 7*20 x 100 cm, Kina G603	stk.	palle		30	1062415	121
blågrå	Parkkantsten 7*20 x 50 cm, Kina G654	stk.			60	1062411	74
blågrå	Parkkantsten 7*20 x 100 cm, Kina G654	stk.	palle		30	1062400	147
rødgrå	Parkkantsten 7*20 x 100 cm, Kina G354	stk.	palle		30	1062419	172
sortgrå	Parkkantsten 7*20 x 50 cm, Kina ER381/G685	stk.			60	1062407	103
sortgrå	Parkkantsten 7*20 x 100 cm, Kina ER381/G685	stk.	palle		30	1062410	208
lysgrå	Parkkantsten 6*15*75 cm, Kina G603	stk.	palle		60	1062412	66
blågrå	Parkkantsten 8*25*50 cm, Kina G654	stk.	palle		48	1062405	106
sortgrå	Parkkantsten 8*25*50 cm, Kina G685	stk.	palle		48	1062409	165
grå	Kantsten 12*26 x 90-110 cm, Kina G341	meter	palle	16,00		1062420	182
grå	Kantsten 12*30 x 90-110 cm, Kina G341	meter	palle	16,00		1062452	232
grå	Faskantsten 15/17*30 cm, Kina G341	meter	palle	12,00		1062460	281
rødgrå	Kantsten 12*30 x 90-110 cm, Kina G354	meter	palle	16,00		1062480	369
rødgrå	Faskantsten 15/17*30 cm, Kina G354	meter	palle	12,00		1062490	534
grå	Kantsten 12*26 x 80-120 cm, Porto	meter	palle	20,00		1062110	186
grå	Kantsten 12*30 x 80-120 cm, Porto	meter	palle	20,00		1062140	204
mørkgrå	Kantsten 12*26 x 80-120 cm, Roriz	meter	palle	20,00		1062112	194
mørkgrå	Kantsten 12*30 x 80-120 cm, Roriz	meter	palle	20,00		1062120	213
grå	Palisader 12*30*100 cm, Kina G341	stk.	palle		12	1062456	271
grå	Palisader 12*30*120 cm, Kina G341	stk.	palle		10	1062457	325
diverse	Kantsten slidt nordisk granit Fra:	meter	palle	10,00		1072011	362
diverse	Faskantsten slidt svensk granit Fra:	meter	palle	10,00		1072060	474



Granit

Kantsten, Radius

farve	navn	enhed	emb.	stk./pl.	Hel cirkel stk.	Varenr.	Salgspris Vejl. kr. stk./m
grå Kina	Kantsten 12*26*78 cm 0,50M	stk	palle	12,00	4	1062421	287
grå Kina	Kantsten 12*26*78 cm 0,75M	stk	palle	12,00	6	1062422	287
grå Kina	Kantsten 12*26*78 cm 1,00M	stk	palle	12,00	8	1062423	287
grå Kina	Kantsten 12*26*78 cm 1,25M	stk	palle	12,00	10	1062424	287
grå Kina	Kantsten 12*26*78 cm 1,50M	stk	palle	12,00	12	1062425	287
grå Kina	Kantsten 12*26*78 cm 2,00M	stk	palle	12,00	16	1062426	287
grå Kina	Kantsten 12*26*78 cm 3,00M	stk	palle	12,00	24	1062428	287
grå Kina	Kantsten 12*26*78 cm 4,00M	stk	palle	12,00	32	1062430	287
grå Kina	Kantsten 12*26*78 cm 5,00M	stk	palle	12,00	40	1062432	287
grå Kina	Kantsten 12*26*78 cm 6,00M	stk	palle	12,00	48	1062434	287
grå Kina	Kantsten 12*26*78 cm 8,00M	stk	palle	12,00	64	1062436	287
grå Kina	Kantsten 12*26*78 cm 10,00M	stk	palle	12,00	80	1062438	287
grå Porto	Kantsten Porto/Roriz 12*30*78 cm 0,50M	stk	palle		4	1062121	407
grå Porto	Kantsten Porto/Roriz 12*30*78 cm 0,75M	stk	palle		6	1062122	407
grå Porto	Kantsten Porto/Roriz 12*30*78 cm 1,00M	stk	palle		8	1062123	407
grå Porto	Kantsten Porto/Roriz 12*30*78 cm 1,25M	stk	palle		10	1062124	407
grå Porto	Kantsten Porto/Roriz 12*30*78 cm 1,50M	stk	palle		12	1062125	407
grå Porto	Kantsten Porto/Roriz 12*30*78 cm 2,00M	stk	palle		16	1062126	407
grå Porto	Kantsten Porto/Roriz 12*30 cm 3,0M	meter	palle		18,84	1062128	379
grå Porto	Kantsten Porto/Roriz 12*30 cm 4,0M	meter	palle		25,12	1062130	379
grå Porto	Kantsten Porto/Roriz 12*30 cm 5,0M	meter	palle		31,40	1062132	379
grå Porto	Kantsten Porto/Roriz 12*30 cm 6,0M	meter	palle		37,68	1062134	379
grå Porto	Kantsten Porto/Roriz 12*30 cm 8,0M	meter	palle		50,24	1062136	379
grå Porto	Kantsten Porto/Roriz 12*30 cm 10M	meter	palle		62,80	1062138	379
X rød, India	Kantsten 12*26*78 cm 0,50 - 2,00M	stk	palle			1062321	604

X = bestillingsvare



Granit

Fliser / Bordursten

farve	navn	enhed			Varenr.	Salgspris
			m2 pr.	stk. pr.		Vejl.
			kasse	kasse		kr/stk./m2
lysgrå	Bordursten 30x7x100 cm G603	stk.	5,40	24,00	1082422	240,52
blågrå	Bordursten 30x7x100 cm G654	stk.	5,40	24,00	1082424	240,52
rødgrå	Bordursten 30x7x100 cm G354	stk.	5,40	24,00	1082423	293,35
sortgrå	Bordursten 30x7x100 cm G684	stk.	5,40	24,00	1082426	484,65
lysgrå	Flise 40 x 40 x 3 cm G603	m2	10,56	66,00	1082478	336,46
blågrå	Flise 40 x 40 x 3 cm G654	m2	10,56	66,00	1082480	341,12
sortgrå	Flise 40 x 40 x 3 cm G684	m2	10,56	66,00	1082481	541,58
lysgrå	Flise 30 x 60 x 3 cm G603	m2	12,24	68,00	1082438	331,23
lysgrå	Flise 30 x 30 x 3 cm G603	m2	12,24	136,00	1082448	331,23
blågrå	Flise 30 x 60 x 3 cm G654	m2	12,24	68,00	1082440	346,35
blågrå	Flise 30 x 30 x 3 cm G654	m2	12,24	136,00	1082450	346,35
rødgrå	Flise 30 x 60 x 3 cm G354	m2	12,24	68,00	1082439	537,90
rødgrå	Flise 30 x 30 x 3 cm G354	m2	12,24	136,00	1082449	537,90
sortgrå	Flise 30 x 60 x 3 cm G684	m2	12,24	68,00	1082442	537,90
sortgrå	Flise 30 x 30 x 3 cm G684	m2	12,24	136,00	1082452	437,81
lysgrå	Flise 30 x 60 x 5 cm G603	m2	7,20	40,00	1082458	515,85
blågrå	Flise 30 x 60 x 5 cm G654	m2	7,20	40,00	1082460	515,85
rød	Flise 30 x 60 x 5 cm G354	m2	7,20	40,00	1082459	738,06
sortgrå	Flise 30 x 60 x 5 cm G684	m2	7,20	40,00	1082463	798,66



Granit

Andre fliser, trædesten m.m.

farve	navn	emb.		Varenr.	Salgspris	
					Vejl.	
			m ² /kasse	stk./kasse	kr/stk.	
lysgrå	trædesten Ø30 x 3 cm savet/jetbrændt	stk.		90	1082401	35,93
blågrå	trædesten Ø30 x 3 cm savet/jetbrændt	stk.		90	1082402	50,18
lysgrå	trædesten Ø40 x 4/6 cm håndhugget	stk.		36	1082410	95,53
blågrå	trædesten Ø40 x 4/6 cm håndhugget	stk.		36	1082412	126,88
rødgrå	trædesten Ø40 x 4/6 cm håndhugget	stk.		36	1082411	151,11
lysgrå	trædesten Ø30 x 4/6 cm håndhugget	stk.		72	1082413	51,33
blågrå	trædesten Ø30 x 4/6 cm håndhugget	stk.		72	1082415	68,43

Trappetrin - jetbrændt m/fas

farve	navn	emb.		Varenr.	Salgspris	
					Vejl.	
				stk./kasse	kr/stk.	
lysgrå	Trin 35 x 15 x 100 cm G603	palle		10	1092490	512,93
lysgrå	Trin 35 x 15 x 150 cm G603	palle		6	1092491	778,40
blågrå	Trin 35 x 15 x 100 cm G654	palle		10	1092494	534,30
blågrå	Trin 35 x 15 x 150 cm G654	palle		6	1092495	853,93
rødgrå	Trin 35 x 15 x 100 cm G354	palle		9	1092492	813,91
rødgrå	Trin 35 x 15 x 150 cm G354	palle		6	1092493	1224,43
sortgrå	Trin 35 x 15 x 100 cm G684	palle		10	1092498	1255,66
sortgrå	Trin 35 x 15 x 150 cm G684	palle		6	1092499	1882,78



Granit

Andre varer

farve	navn	emb.		Varenr.	Salgspris
					Vejl.
			stk./ks.		kr/stk.
flammet	Obelisk ca. 80 cm med hul	stk.	8	1502320	497
grå	fuglebade 31x24x8 cm	stk.	40	1502410	149
blå	Bænksæt TB87 98x35xH4+45 cm	stk.	4	1503754	847
grå	Bænksæt TB88 100x30xH6+36 cm	stk.	4	1503755	750
grå/blå	Kompasrose Ø80x5 cm	stk.	18	1502420	1454
blå	Kompasrose Ø40x4 cm	stk.	40	1448643	441
grå	Kugle ø 30 cm, stokhugget	stk.	18	1502483	360
grå	Kugle ø 40 cm, stokhugget	stk.	4	1502484	647

Pullert / stolper

farve	navn	emb.		Varenr.	Salgspris
					Vejl.
			stk./ks.		kr/stk.
grå	Kløvet 20x20x120 cm Porto	stk	15	1092101	807
blågrå	Kløvet 20x20x120 cm Roriz	stk	15	1092102	910
rødgrå	Firkant 20x20x120 cm G354	stk	9	1092404	794
X lysgrå	Rund stokhugget Ø20x68 cm G603	stk	6	1092410	1090

Vandsten / Fontæne

farve	navn	emb.		Varenr.	Salgspris
					Vejl.
					kr/stk
blågrå	FG11 Kegle komplet m/balje, pumpe og lys	balje	1	1503597	1827
blågrå	FG36 Blomst komplet m/balje, pumpe og lys	balje	1	1503596	2028
blågrå	FE66 3 Kugler komplet m/balje, pumpe og lys	balje	1	1503598	2178
lysgrå	Fe88 3 Søjler komplet m/balje, pumpe og lys	balje	1	1503599	1437
blågrå	figur FP01 komp. m/rattanbalje, pumpe	kurv	1	1503551	2438
blågrå	figur FP02 komp. m/rattanbalje, pumpe	kurv	1	1503552	2381
beige	figur FP03 komp. m/rattanbalje, pumpe	kurv	1	1503553	3665
blågrå	figur FP05 komp. m/rattanbalje, pumpe	kurv	1	1503555	2496
X blågrå	figur FP08 komp. m/rattanbalje, pumpe	kurv	1	1503558	1686
X blågrå	figur FP09 komp. m/rattanbalje, pumpe	kurv	1	1503559	1853

Bigbag / Paller / Plukkegebyr

farve	navn	emb.	ca.	Varenr.	
			stk/m ²		
	Bigbag á 1.200 kg - engangs	stk.		1120	295
	Granit Paller - engangs	stk.		1110	101
	Gebyr for pluk/anbrud granit	stk.		1135	295

Der tages forbehold for evt. prisstigninger og trykfejl, og henvises i øvrigt til producenternes anvisninger.

X Angiver at det er skaffevare

Fliserens/-imprægnering, gulvprodukter

Pris inkl. levering, ved levering af hele paller.							
Vare-	navn	enhed	stk.	stk.	pr. stk.	pr. stk.	pr. stk.
nummer			pr. pl.	pr. ks.	ved 1 pl.	ved 2-3 pl.	ved 4+ pl.
61011	Laksæbe	1 liter	576	12	48,00	42,00	36,00
61021	Gulvsæbe neutral	1 liter	576	12	48,00	42,00	36,00
61031	Gulvsæbe hvid	1 liter	576	12	52,20	45,68	39,15
61041	Gulvsæbe hvid m/voks	1 liter	576	12	62,40	54,60	46,80
61051	Lud hvid nåletræ	1 liter	576	12	46,80	40,95	35,10
61061	Lud hvid universal	1 liter	576	12	51,48	45,05	38,61

Vare-	navn	enhed	stk.	stk.	pr. stk.	pr. stk.	pr. stk.
nummer			pr. pl.	pr. ks.	ved 1 pl.	ved 2-3 pl.	ved 4+ pl.
61012	Laksæbe	2,5 liter	255	3	94,50	82,70	70,88
61022	Gulvsæbe neutral	2,5 liter	255	3	94,50	82,70	70,88
61032	Gulvsæbe hvid	2,5 liter	255	3	105,00	91,88	78,75
61042	Gulvsæbe hvid m/voks	2,5 liter	255	3	130,50	114,20	97,88
61052	Lud hvid nåletræ	2,5 liter	255	3	91,50	80,10	68,63
61062	Lud hvid universal	2,5 liter	255	3	100,65	88,11	75,50
61062	Fliseimprægnering	2,5 liter	255	3	123,75		
61072	Fliserens	2,5 liter	255	3	64,50		

Vare-	navn	enhed	stk.	stk.	pr. stk.	pr. stk.	pr. stk.
nummer			pr. pl.	pr. ks.	ved 1 pl.	ved 2-3 pl.	ved 4+ pl.
61015	Laksæbe	5 liter	144		156,00	136,50	117,00
61025	Gulvsæbe neutral	5 liter	144		156,00	136,50	117,00
61035	Gulvsæbe hvid	5 liter	144		177,00	154,88	132,75
61045	Gulvsæbe hvid m/voks	5 liter	144		228,00	199,50	171,00
61055	Lud hvid nåletræ	5 liter	144		150,00	131,25	112,50
61065	Lud hvid universal	5 liter	144		165,00	144,38	123,75



Bigbags 0,5 m³

Frit leveret, +engangspalle		Bigbag á 1/2 m ³	Jylland v/ 1 pl	Sjælland v/1 pl
Mørteltype		Varenummer	Leveret	Leveret
Bakkemørtel KC 20/80/550	3,50%	61448951	597	693
Bakkemørtel KC 35/65/650	5,10%	61448949	604	700
Bakkemørtel KC 50/50/700 0-4mm	6,60%	61447779	623	719
Bakkemørtel	9,00%	61447780	676	772
Strandmørtel 0-2mm	7,70%	61448124	632	728
Strandmørtel	9,00%	61448955	691	787
Grus & sten				
Marmorskærver hvide	8-16mm	61449034	897	993
Perler blå	8-16mm	61449023P	680	776
Perler grå	8-16mm	61449024	546	642
Perler hvide	8-16mm	61449025	546	642
Pigsten	90-150mm	61449074	1084	1180
Pigsten (gabionsten)	150-300mm	61505286	1084	1180
Sandbl./støbemix	0-8mm	61449084	505	601
Sandbl./støbemix	0-16mm	61449087	505	601
Granitskærver grå	8-11mm	61457905	680	776
Granitskærver grå	11-16mm	61449010	680	776
Granitskærver grå	16-32mm	61449011	680	776
Granitskærver hvide	4-8mm	61457976	770	866
Granitskærver hvide	8-11mm	61449019	770	866
Granitskærver rød/sorte	8-16mm	61580071	770	866
Granitskærver sorte	8-11mm	61449013	770	866
Granitskærver sorte	11-16mm	61449014	770	866
Granitskærver sorte	16-32mm	61449015	770	866
Granitskærver sorte	32-64mm	61449016	770	866
Granitskærver sorte (gabionsten)	150-300mm	61505218	770	866
Stenmel grå		61449005	695	791
Stenmel sort		61449006	695	791
Stenmel hvid		61581991	828	924
Stabilgrus		61457985	537	633
Herregårdsgrus		61449077	637	733
Sand				
Flise-/pudse-/støbesand		61449030	505	601
Legepladssand		61449032	638	734
Strandsand	OBS! Nyt nr.	61449079	537	633
Strøsand tilsat salt		61449089	740	836
Diverse				
Havemuld		61449023	568	664
Spagnum		61449022	645	741
Flis		61449021	645	741
Bark		61449020	645	741
Weber Leca 2,5 m ³	10-20mm	61449999	2982	3087
Emballage				
Engangspaller +			101	101

Sække

Frit leveret, + engangspalle			Jylland v/ 1 pl	Sjælland v/1 pl
Pose á 15l., 42 ps. pr. pl.		Varenummer	Leveret	Leveret
Bakkemørtel KC 50/50/700	6,60%	61455491	1124	1220
Strandmørtel	7,70%	61461140	1124	1220
Marmorskærver hvide	8-16mm	61449033	1654	1750
Granitskærver grå	8-11mm	61449001	1004	1100
Granitskærver grå	11-16mm	61480204	1004	1100
Granitskærver hvide	4-8mm	61457977	1004	1100
Granitskærver hvide	8-11mm	61530495	1004	1100
Granitskærver rød/sort	8-16mm	61580081	1004	1100
Granitskærver sorte	8-11mm	61449091	1004	1100
Granitskærver sorte	11-16mm	61480202	1004	1100
Stenmel grå		61457914	1004	1100
Stenmel sort		61457941	1004	1100
Stenmel hvid		61581992	1254	1350
Herregårdsgrus		61449077	1004	1100
Flise-/pudse-/støbesand		61449026	1004	1100
Legepladssand		61449031	1341	1437
Strandsand		61449078	1047	1143
Strøsand tilsat salt		61449088	1163	1259
Cement basis, 42 ps. á 25 kg		61449996	dagspris	dagspris
Stampet kalk, 22 spande pr. palle				
Stampet kalk i spande á 25kg		61449107	2121	2217
Stampet kalk i spande á 12,5kg		61449106	1708	1804
Weber Leca, 21 sække pr. palle				
Weber Leca sække á 50 liter	10-20mm	61449998	dagspris	dagspris
Weber Leca sække á 50 liter	4-10mm	61449997	dagspris	dagspris
Emballage				
Engangspaller +			101	101



Bigbags 1000 kg/ 1m³

Bigbag 1000 kg, frit leveret			Jylland	Sjælland
Varebetegnelse	Varenummer		pr. bag	pr. bag
Filtergrus 2-4	61817999		846	942
Filtergrus 2-8	61817998		846	942
Filtersand 0-8	61817997		758	854
Kampesten 300-600 mm	61817996		1284	1380
Pigsten 90/150	61817641		1253	1349
Pigsten 150/300	61817643		1253	1349
Perler grå 8-16 mm	61817995		821	917
Perler brun 8-16 mm	61654529		895	991
Perler blå 8-16 mm	61817633		895	991
Perler hvid 8-16mm	61817636		864	960
Perler hvid 4-8 mm	61817654		864	960
Perler brun 4-8 mm	61654526		895	991
Sandblanding/støberal 0-8 mm	61817648		795	891
Sandblanding/støberal 0-16 mm	61817649		795	891
Pyntesten singles grå 20-40 mm	61817994		814	910
Pyntesten singles grå 40-60 mm	61817993		814	910
Pyntesten singles hvid 16-32 mm	61817650		823	919
Pyntesten singles hvid 30-70 mm	61817992		816	912
Granitskærver grå 8/11	61817651		1077	1173
Granitskærver grå 11/16	61817652		1077	1173
Granitskærver grå 16/32	61817653		1077	1173
Granitskærver grå 32/64	61817991		1077	1173
Granitskærver sort 8/11	61817658		1138	1234
Granitskærver sort 11/16	61817659		1138	1234
Granitskærver sort 16/32	61817660		1138	1234
Granitskærver sort 32/64	61817990		1138	1234
Granitskærver sort 100/200	61817661		1138	1235
Granitskærver rød/sort 8/16	61817657		1154	1250
Stenmel sort 0-2 mm	61817665		1023	1119
Stenmel grå 0-2 mm	61817663		1023	1119
Stabilgrus	61817662		795	891
Stigrus/herregårdsgrus	61817666		1080	1176
Knust asfalt	61817989		829	925
Knust beton	61817988		776	872
Vaskede nødder 16/32	61817987		814	910
Fyldsand	61817986		694	790
Strandsand 0-2 mm	61817669		785	881
Vasket sand	61817985		785	881
Flise-/pudse-/støbesandsand 0-7mm	61817667		785	881
Legepladssand 0-5 mm CE mærket	61817668		1018	1114
Harpet muldjord	61817984		769	865
Bigbag 1 m³, frit leveret			pr. bag	pr. bag
Bark	61817983		989	1085
Flis	61817982		989	1085
Spagnum	61817681		989	1085
Muslingeskaller	61817980		989	1085

Aeroc porebeton

Priser ab værk. Tillæg for fragt + engangspalle. Lev. i hele paller.

		antal	antal			Varenr.	Vejl.
		pr. pl.	pr. pl.	kg.pr.	Densitet		Ab værk
Navn	BxHxL(mm)	stk.	m ³	stk.	kg/m ³	Varenr.	kr/stk./m
Aeroc Ecoterm plus 500	500x200x600	24	1,44	24,30	300	3502060PBE	63,30
Aeroc Ecoterm plus 375	375x200x600	32	1,44	18,20	300	3372060PBE	47,48
Aeroc Ecoterm plus 300	300x200x600	40	1,44	14,60	300	3302060PBE	37,98
Aeroc Universal stående	200x300x600	40	1,44	18,20	375	3203060PBU	37,98
Aeroc Universal liggende	300x200x600	40	1,44	18,20	375	3302060PBU	37,98
Aeroc Classic 300	300x200x600	40	1,44	20,60	425	3302060PB	40,10
Aeroc Classic 250	250x200x600	48	1,44	17,20	425	3252060PB	33,41
Aeroc Classic 200	200x200x600	56	1,34	13,80	425	3202060PB	26,61
Aeroc Classic 150	150x200x600	80	1,44	10,30	425	3152060PB	20,04
Aeroc Classic 100	100x200x600	120	1,44	6,90	425	3102060PB	13,37
Aeroc Acoustic 250	250x200x600	48	1,44	23,30	575	3252060PBA	35,21
Aeroc Acoustic 150	150x200x600	80	1,44	14,00	575	3152060PBA	21,12
Aeroc Hard 300	300x200x600	40	1,44	27,90	575	3302060PBH	38,52
Aeroc Hard 250	250x200x600	48	1,44	23,30	575	3252060PBH	32,10
Aeroc Hard 200	200x200x600	56	1,34	18,60	575	3202060PBH	25,55
Aeroc Plade 150	150x400x600	40	1,44	26,00	535	3154060PB	34,37
Aeroc Plade 125	125x400x600	48	1,44	22,00	535	3124060PB	28,95
Aeroc Plade 100	100x400x600	60	1,44	17,30	535	3104060PB	22,91
Aeroc Plade 75	75x400x600	80	1,44	13,00	535	3754060PB	17,18
Aeroc Element 150	150x400x600	40	1,44	21,00	425	3154060PBE	36,28
Aeroc Element 100	100x400x600	60	1,44	14,00	425	3104060PBE	24,19
Aeroc Element 75	75x400x600	80	1,44	10,50	425	3754060PBE	19,23
Aeroc Element 50	50x400x600	104	1,25	8,00	425	3504060PBE	13,40
Aeroc lux 100	100x575x575	8	1,06	88,00	475	310575575PB	38,46
Aeroc lux 100	75x575x575	11	1,09	66,18	475	375575575PB	28,84
Aeroc U-blok 500	500x200x500	10		14,70	300	3502050PBUB	127,50
Aeroc U-blok 375	375x200x500	20		11,98	300	3372050PBUB	84,00
Aeroc U-blok 300	300x200x500	20		12,40	300	3302050PBUB	75,00
Aeroc U-blok 250	250x200x500	30		9,20	300	3252050PBUB	54,00
Aeroc U-blok 200	200x200x500	40		7,40	300	3202050PBUB	43,50



Aeroc Overliggerer - tørdensitet 500 kg/m³

B x H x L	kg. pr. stk.	Varenummer	Vejl. kr/stk./m
100x200x1200	18	31020120PBO	189
100x200x1600	23	31020160PBO	201
100x200x2000	29	31020200PBO	261
100x200x2400	35	31020240PBO	338
150x200x1200	26	31520120PBO	287
150x200x1600	41	31520160PBO	377
150x200x2000	60	31520200PBO	566
150x400x1600	72	31540160PBO	369
150x400x2000	90	31540200PBO	576
150x400x2400	111	31540240PBO	666
150x400x3000	147	31540300PBO	846
200x200x1600	52	32020160PBO	498
200x200x2000	72	32020200PBO	648
200x200x2400	98	32020240PBO	786
200x200x3000	125	32020300PBO	1109
250x200x1600	64	32520160PBO	617
250x200x2000	85	32520200PBO	755
250x200x2400	114	32520240PBO	948
250x200x3000	146	32520300PBO	1437
300x200x1600	75	33020160PBO	704
300x200x2000	98	33020200PBO	836
300x200x2400	128	33020240PBO	1029
300x200x3000	167	33020300PBO	1520
375x200x1600	90	33720160PBO	803
375x200x2000	117	33720200PBO	960
375x200x2400	151	33720240PBO	1200
375x200x3000	197	33720300PBO	1545
500x200x1600	120	35020160PBO	1070
500x200x2000	154	35020200PBO	1278
500x200x2400	196	35020240PBO	1596
500x200x3000	251	35020300PBO	2051
500x400x2000	274	35040200PBO	1265
500x400x2400	329	35040240PBO	1482
500x400x3000	414	35040300PBO	1841
500x400x3600	498	35040360PBO	2141
500x400x4000	566	35040400PBO	2427
500x400x4800	693	35040480PBO	4830
500x600x5600	1.137	35060560PBO	6489
500x600x6000	1.253	35060600PBO	6792



Aeroc Overliggerer - tørdensitet 500 kg/m³

			Vejl.
B x H x L	kg. pr.		
	stk.	Varenummer	kr/stk./m
200x400x1600	93	32040160PBO	503
200x400x2000	115	32040200PBO	644
200x400x2400	143	32040240PBO	761
200x400x3000	184	32040300PBO	1050
200x400x3600	223	32040360PBO	1284
200x400x4000	262	32040400PBO	1559
200x600x5200	476	32060520PBO	4185
200x600x6000	548	32060600PBO	4520
250x400x1600	114	32540160PBO	626
250x400x2000	143	32540200PBO	761
250x400x2400	175	32540240PBO	941
250x400x3000	221	32540300PBO	1395
250x400x3600	268	32540360PBO	1521
250x400x4000	311	32540400PBO	1824
250x400x4400	345	32540440PBO	2648
250x600x5200	584	32560520PBO	4658
250x600x6000	670	32560600PBO	4992
300x400x1600	134	33040160PBO	708
300x400x2000	169	33040200PBO	852
300x400x2400	206	33040240PBO	1031
300x400x3000	260	33040300PBO	1484
300x400x3600	315	33040360PBO	1680
300x400x4000	364	33040400PBO	2000
300x400x4400	404	33040440PBO	2835
300x600x5200	688	33060520PBO	5019
300x600x6000	800	33060600PBO	5745
375x400x1600	167	33740160PBO	824
375x400x2000	208	33740200PBO	977
375x400x2400	253	33740240PBO	1215
375x400x3000	319	33740300PBO	1596
375x400x3600	385	33740360PBO	1857
375x400x4000	428	33740400PBO	2016
375x400x4400	475	33740440PBO	3092
375x400x4800	515	33740480PBO	4304
375x600x5200	837	33760520PBO	5471
375x600x5600	901	33760560PBO	5969
375x600x6000	965	33760600PBO	6245



Aeroc loftselement/tagelement

						Vejl.
Længde af en typeplade		Vægt pr.				
modul mm	B x H(mm)	pl. kg.		Varenummer		kr/stk./m
2000	600x250				36025200PBL	806
2200	600x250				36025220PBL	887
2400	600x250	243			36025240PBL	966
2600	600x250				36025260PBL	1047
2800	600x250	284			36025280PBL	1128
3000	600x250				36025300PBL	1209
3200	600x250	324			36025320PBL	1289
3400	600x250				36025340PBL	1370
3600	600x250	365			36025360PBL	1451
3800	600x250				36025380PBL	1530
4000	600x250	405			36025400PBL	1611
4200	600x250x				36025420PBL	1692
4400	600x250	446			36025440PBL	1772
4600	600x250				36025460PBL	1853
4800	600x250	486			36025480PBL	1934
5000	600x250				36025500PBL	2133
5200	600x250	527			36025520PBL	2217
5400	600x250				36025540PBL	2303
5600	600x250	567			36025560PBL	2388
6000	600x250	608			36025600PBL	2559
Tørdensitet 500 30kg/m ³						
Bæreevne 4,0kN/m ²						
U-værdi 0,13W/mK						

Aeroc vægelement-tørdensitet 500kg/m³

		Brand-	Brand-			
		fasthed	fasthed	Varmetransmission v.		
B x H x L (mm)	Vægt kg	El	El-M	5% fugtighed	Varenummer	
150/600/6000	381	El 240		0,90W/(m ² K)	31560600PBV	575
200/600/6000	506	El 240	El-M 90	0,70W/(m ² K)	32060600PBV	645
250/600/6000	626	El 240	El-M180	0,57W/(m ² K)	32560600PBV	699
300/600/6000	747	El 240	El-M180	0,49W/(m ² K)	33060600PBV	756
375/600/6000	929	El 240	El-M180	0,40W/(m ² K)	33760600PBV	854



Aeroc

Mørtel		Varenr.	Vejl.
Navn	stk.		kr/stk./m
Tyndlagsmørtel til blokke 25 kg	1	34060PBLB	117,00
Tyndlagsmørtel til blokke, vinter 25 kg	1	34060PBLBV	121,50
Tyndlagsmørtel til skillevægspalder 25 kg	1	34060PBL	121,50
Tyndlagsmørtel til skillevægspal., vinter 25 kg	1	34060PBLV	129,00
Reperationsmørtel 20 kg	1	34060PBRM	148,50
Reperationsmørtel, vinter 20 kg	1	34060PBRMV	153,00
Hjælpe midler			
Navn	stk.		
Fugesøm 100 stk. pr. ks.	1	34060PBS	91,50
Aluminiumsstave 25 stk.	1	34060PBAS	93,00
Klamme til deformationsfuge	1	34060PBK	43,50
Forbindelsesbeslag til vægge	1	34060PBFK	42,00
Glittebræt	1	34060PBG	255,00
Sav	1	34060PBSA	298,50
Mørtelslæde, 500mm	1	3406050PBM	769,50
Mørtelslæde, 375mm	1	3406037PBM	478,50
Mørtelslæde, 300mm	1	3406030PBM	441,00
Mørtelslæde, 250mm	1	3406025PBM	435,00
Mørtelslæde, 200mm	1	3406020PBM	427,50
Mørtelslæde, 150mm	1	3406015PBM	390,00
Murerske, 200mm	1	340602mPBMU	199,50
Murerske, 150mm	1	3406015PBMU	187,50
Murerske, 100mm	1	3406010PBMU	181,50
Murerske, 75mm	1	340607PBMU	181,50
Murerske, 50mm	1	340605PBMU	181,50

Pudsesystem Porebeton

Priser ab værk, ex. moms. Tillæg fragt + engangspalle.			
Navn	varenr.	Dimension	
Glasfiber armeringsnet	34060PBGA	1x50 m	873,54
Bundlister	34060PBB	3mmx 200cm	37,95
Glasfiberhjørner	32525250PBGL	25x25x250cm	46,23
Fibermørtel	34060PBFM	18 kg	95,64
Blokspartel	34060PBBS	25 kg	182,85
Blokkløb	34060PBBK	25 kg	153,09



FLAMINGO

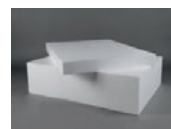

Priser ab værk. Ved køb over 4600,- ex. moms, fragtfrit leveret Jyll./Fyn.							
Ved køb under 4600,- ex. moms, tillæg fragt 920,- Jyll./Fyn. Sjælland spørg for pris.							
Navn	Varenr.	stk.	Dimension	Tykkelse	Enhed	0-40m3	40m3->
		pr. pl.	(BxL mm)	(mm)			
						pris pr. m2	pris pr. m2
D80	51675026				m3	500,25	414,00
B60 Grafit	51811785				m3	638,25	569,25
B80 Grafit	51675050				m3	655,50	586,50
D80 (lambda 0,038)	51268800	50	910x1210	50	m2	25,01	20,70
D80 (lambda 0,038)	51268801	36	910x1210	75	m2	37,52	31,05
D80 (lambda 0,038)	51268802	26	910x1210	100	m2	50,03	41,40
D80 (lambda 0,038)	51604019	22	910x1210	125	m2	62,52	51,75
D80 (lambda 0,038)	51268804	18	910x1210	150	m2	75,03	62,10
D80 (lambda 0,038)	51604024	16	910x1210	175	m2	87,54	72,45
D80 (lambda 0,038)	51208805	14	910x1210	200	m2	100,05	82,80
D80 (lambda 0,038)	51268806	12	910x1210	220	m2	110,06	91,08
D80 (lambda 0,038)	51604025	11	910x1210	250	m2	125,06	103,50
D80 (lambda 0,038)	51268807	10	910x1210	275	m2	137,57	113,85
D80 (lambda 0,038)	51673341	9	910x1210	300	m2	150,08	124,20
D80 (lambda 0,038)	51673347	8	910x1211	320	m2	160,08	132,48
D80 (lambda 0,038)	51673350	7	910x1212	400	m2	200,10	165,60
B60 Grafit (lambda 0,033)	51811774	23	910x1210	120	m2	76,59	68,31
B60 Grafit (lambda 0,033)	51811779	17	910x1210	160	m2	102,12	91,08
B60 Grafit (lambda 0,033)	51811781	16	910x1210	175	m2	111,69	99,62
B60 Grafit (lambda 0,033)	51811782	11	910x1210	240	m2	153,18	136,62
B80 Grafit (lambda 0,031)	51736115	120	600x910	10	m2	6,56	6,56
B80 Grafit (lambda 0,031)	51736116	80	600x910	15	m2	9,83	9,83
B80 Grafit (lambda 0,031)	51736117	60	600x910	20	m2	13,11	13,11
B80 Grafit (lambda 0,031)	51736118	50	600x910	25	m2	16,38	16,38
B80 Grafit (lambda 0,031)	51736119	40	600x910	30	m2	19,67	19,67
B80 Grafit (lambda 0,031)	51736121	35	600x910	35	m2	22,94	22,94
B80 Grafit (lambda 0,031)	51726123	30	600x910	40	m2	26,22	26,22
B80 Grafit (lambda 0,031)	51736127	50	910x1210	50	m2	32,78	29,33
B80 Grafit (lambda 0,031)	51736128	36	910x1210	75	m2	49,16	43,98
B80 Grafit (lambda 0,031)	51736130	26	910x1210	100	m2	65,55	58,65
B80 Grafit (lambda 0,031)	51736132	22	910x1210	125	m2	81,93	73,31
B80 Grafit (lambda 0,031)	51736133	18	910x1210	150	m2	98,33	87,98
B80 Grafit (lambda 0,031)	51736135	17	910x1210	160	m2	104,88	93,84
B80 Grafit (lambda 0,031)	51736137	14	910x1210	200	m2	131,10	117,30
B80 Grafit (lambda 0,031)	51736139	12	910x1210	230	m2	150,77	134,90
B80 Grafit (lambda 0,031)	51736140	10	910x1210	265	m2	173,70	155,42
B80 Grafit (lambda 0,031)	51736143	9	910x1210	300	m2	196,65	175,95
B80 Grafit (lambda 0,031)	51736146	8	910x1210	320	m2	209,76	187,68
B80 Grafit (lambda 0,031)	51736148	7	910x1211	360	m2	235,98	211,14
B80 Grafit (lambda 0,031)	51736149	7	910x1212	380	m2	249,09	222,87

Rullegræs

	Ab værk	Antal pr. palle			
Rullegræs pr. m2 inkl. palle	21	50 m2			
Gebyr v/ordrer under 50m2	90				

Fragtpriser		
Antal paller pr. stk.	Jylland/m2	Sjælland/m2
1-2 paller	525/31,50	630/33,60
3-4 paller	399/28,98	495/30,90
5-10 paller	359/28,18	420/29,40
11-20 paller	278/26,56	330/27,60



Brænde, frit leveret

Ovntørret pejsebrænde prima kvalitet		Leveret	Leveret	Leveret	Leveret
Vare	Varenummer	pr. pl. v/1 pl.	pr. pl. v/2pl.	pr. pl. v/4 pl.	pr. pl. v/6pl.
Ask i palletårn ca. 1,8m ³	8829901352	2340	2235	2190	2145
Eg i palletårn ca. 1,8m ³	8829901362	2340	2235	2190	2145
Birk i palletårn ca. 1,8m ³	8829901372	2178	2073	2028	1983
Avnbøg i palletårn ca. 1,8m ³	8829901392	2363	2258	2213	2168
Bøg i palletårn ca. 1,8m ³	8829901342	2460	2355	2310	2265
Bl. Løv i palletårn ca. 1,8m ³	8829901382	2007	1902	1857	1812
Hele træk	Varenummer	Pr. pl.			
Ask i palletårn ca. 1,8m ³	8829901352T	2130			
Eg i palletårn ca. 1,8m ³	8829901362T	2130			
Birk i palletårn ca. 1,8m ³	8829901372T	1968			
Avnbøg i palletårn ca. 1,8m ³	8829901392T	2153			
Spørg løbende efter priser, hele træk er dagspris.					
Sække	Varenummer	Leveret	Leveret	Leveret	Leveret
		pr. pl. v/1 pl.	pr. pl. v/2pl.	pr. pl. v/4 pl.	pr. pl. v/6 pl.
Løvtræ i 30ltr.netsække,	81005019	2438	2333	2288	2243
102 stk. pr. pl., længde 25-30cm.					
Løvtræ optændingspinde 15ltr.,	81005020	3143			
192 stk. pr. pl.					
Optænding i 15 ltr. sække	81005018	3191	3086	3041	2996
210 sk. pr. pl.					
Lufttørret pejsebrænde prima kvalitet		Leveret	Leveret	Leveret	Leveret
Vare	Varenummer	pr. pl. v/1 pl.	pr. pl. v/2 pl.	pr. pl. v/4 pl.	pr. pl. v/6 pl.
Ask i palletårn ca. 1,8m ³	8829925900	2118	2013	1968	1923
Eg i palletårn ca. 1,8m ³	8829925950	2118	2013	1968	2190
Bl. Løvtræ i palletårn ca. 1,8m ³	8829925940	1868	1763	1718	1672,5
Birk i palletårn ca. 1,8 m ³	8829925930	1947	1842	1797	1752
		Pr. pl. v/			
Hele træk	Varenummer	helt træk			
Eg i palletårn ca. 1,8m ³	8829925950T	1893			
Ask i palletårn ca. 1,8m ³	8829925900T	1893			
Bl. Løvtræ i palletårn ca. 1,8m ³	8829925940T	1643			
Birk i palletårn ca. 1,8 m ³	8829925930T	1722			



Briketter prima kvalitet		Leveret	Leveret	Leveret	Leveret
Vare	Varenummer	pr. pl. v/1 pl.	pr. pl. v/2 pl.	pr. pl. v/4 pl.	pr. pl. v/6 pl.
Træbriketter RUF 96pk. pr. pl. 960 kg.	89501982	2085	1980	1935	1890
Pini-kay træbriketter pr. pl. 960 kg.	89501982-BI	2337	2232	2187	2142
Svenske træbriketter pr. pl. 960 kg.	89501982S	2160	2100	2040	2010
Hele træk		Pr. pl.			
Træbriketter RUF 96pk. pr. pl. 960 kg.	89501982T	1905			
Biostænger -overnight					
Biostænger pr. pl. ca. 910 kg	89501982-B	2490	2430	2370	2340
Træpiller prima kvalitet		Leveret	Leveret	Leveret	Leveret
Vare	Varenummer	pr. pl. v/1 pl.	pr. pl. v/2 pl.	pr. pl. v/4 pl.	pr. pl. v/6 pl.
Træpiller 8mm. Neova	8149435	2235	2175	2115	2085
56sk. pr. pl. á 16kg.					
Træpiller 6mm. Neova	8149436	2235	2175	2115	2085
56 sk. pr. pl. á 16kg					
Premium træpiller 8mm	861000-1-8	2093	2048	2010	1988
56 sk. pr. pl. á 16kg					
Premium træpiller 6mm	861000-1-6	2093	2048	2010	1988
56 sk. pr. pl. á 16kg					
Heatlets Standard træpiller 8mm	8149435H8S	2213	2175		2138
60 sk. á 15 kg. pr. pl.					
Heatlets Standard træpiller 6mm	8149435H6S	2213	2175		2138
60 sk. á 15 kg. pr. pl.					
Heatlets Premium træpiller 8 mm	8149435H8	2243	2216		2175
60 sk. á 15 kg. pr. pl.					
Heatlets Premium træpiller 6 mm	8149435H615	2243	2216		2175
60 sk. á 15 kg. pr. pl.					
Heatlets Premium træpiller 6 mm	8149435H6	2333	2288		2250
90 sk. á 10 kg. pr. pl.					
Hele træk		pr. pl.			
Træpiller 8mm. Neova	8149435T	2018			
Træpiller 6mm. Neova	8149436T	2018			
Premium træpiller 8mm	861000-1-8	1950			
Premium træpiller 6mm	861000-1-6	1950			



Brændeovne	Varenummer	Vejledende salgspris	
Skagen Brændeovn Asgård 10	SKA-A10	4595	
Skagen Marta Brændeovn 8,5 KW	7001Ma	6495	
Skagen Brændeovn	1234SB	8995	
Morsø Brændeovn 6143 EN/N m/åben sokkel	1877157	10995	
Skagen Brændeovn Patty	7002PA	11995	



Træpilleovne	Varenummer	Vejledende salgspris	
Træpilleovn Camilla Rød, 4kw 66m2	5000TPO	7100	
Træpilleovn Camilla Beige, 4kw 66m2	5001TPO	7100	
Træpilleovn Lory Bordeaux, 8kw 133m2	5002TPO	8800	
Træpilleovn Lory Sand, 8kw 133m2	5003TPO	8800	
Træpilleovn Lory Sort, 8kw 133m2	5004TPO	8800	
Træpilleovn Lory hvid, 8kw 133m2	5005TPO	8800	

Træpilleovne	Varenummer	Vejledende salgspris	
Træpilleovn Delia Sort, 9kw 150m2	5006TPO	9200	
Træpilleovn Delia Bordeaux, 9kw 150m2	5007TPO	9200	
Træpilleovn Delia Hvid, 9kw 150m2	5008TPO	9200	
Træpilleovn Susy Rød 7,5kw 125m2	5009TPO	11150	
Træpilleovn Susy Sand 7,5kw 125m2	5010TPO	11150	
Træpilleovn Susy Sort 7,5kw 125m2	5011TPO	11150	

Træpilleovne	Varenummer	Vejledende salgspris	
Træpilleovn Tonda Rød 9,5kw 158m2	5012PO	13450	
Træpilleovn Tonda Sand 9,5kw 158m2	5013TPO	13450	
Træpilleovn Tonda Sort 9,5kw 158m2	5014TPO	13450	
Træpilleovn Tosca Rød 12,6kw 210m2	5015TPO	22650	
Træpilleovn Tosca Beige 12,6kw 210m2	5016TPO	22650	



Tilbehør	Varenumm	Vejledende salgspris	
RØGRØR 80 LÆNGDE 250MM	19-110	171	
RØGRØR 80 LÆNGDE 500MM	19-130	210	
RØGRØR 80 LÆNGDE 1000MM	19-150	315	
RØGRØR 80 LÆNGDE 2000MM	19-174	603	
Røgrør 80 T-sektionm. 45 gdr, rens	19-288	490,5	
Røgrør 80 Standard sæt	19-950	1330	
Røgrør 80 Bøjning 2x45 grd.	19-250	393	
Røgrør 80 Bøjning 2x45 grd. med dør	19-252	523	
Røgrør 80 Bøjning 45 grd.	19-240	352	
Røgrør 80 Bøjning 45 grd. med dør	19-242	393	

Tilbehør	Varenummer	Vejledende salgspris	
Røgrør 80 med 250mm forskydning.	19-176	1048	
Røgrør 80 Uniko bøsning med muffe	19-642	393	
Røgrør 80 kobling til montering	19-188	393	
Sort Stålgulvplade til Brændeovne 950x1000 mm	12940-01	895	
Fjernbetjening	95101500	500	

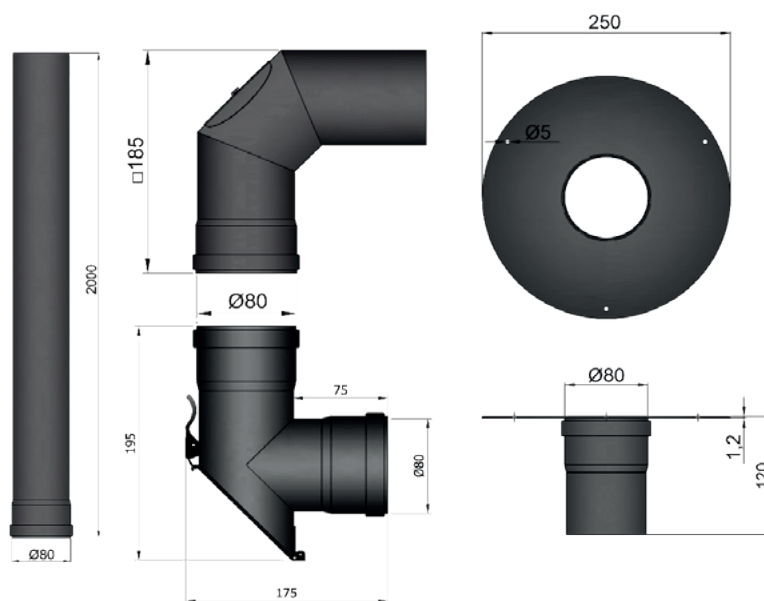

Salt

Salt, leveres på returpaller + kr. 100,-. Priser inkl. levering, + palle 100,-, ekskl. moms.							
Vare	Pris pr. pl. v/						Varenr.
	1 pl	2 pl.	6-10 pl.	11-15 pl.	16-29 pl.	30+ pl.	
Stenvejsalt, 25 kg. sække, 40 sække pr. pl.	1512	1362	1320	1278	1245	1134	613120
Havvejsalt, 25 kg. Sække, 40 sække pr. pl.	1512	1362	1320	1278	1245	1134	613100
Vejsalt, 25 kg. sække, 40 sække pr. pl.	1287	1137	1095	1053	1020	909	612123
Stenvejsalt, bigbag 1.000 kg.	1512	1362	1320	1278	1245	1134	612137
Stenvejsalt, 15 kg., 66 sække pr. pl.	1647	1497	1643	1413	1380	909	612115
Stenvejsalt/havvejsalt, løst udleveret pr. 1.000 kg	749						613110
Løst vejsalt udleveres fra Fredericia/Aarhus/Køge							
Industri/Fødevarer salt	1 pl.	2-5 pl.	6-10 pl.	11-15 pl.	16-29 pl.	30+ pl.	
Prod./Industrisalt, 25 kg. sække, 1050kg. pr. pl.	2010	1860	1818	1776	1743	1632	612820
Fint raffineret salt, 25 kg. sække, 1.050kg. pr. pl.	2322	2172	2130	2088	2055	1944	614210
Blødgørings salt							
Soft salttabletter, 10 kg. sække, 1.000 kg. pr. pl.	3210	3060	3018	2976	2943	2832	614990
Soft salttabletter, 25 kg. sække, 1.000 kg. pr. pl.	2970	2820	2778	2736	2703	2592	614900
Soft havsalt 5-15, 25 kg. sække, 1.000 kg. pr. pl.	2936	2745	2676	2628	2595	2474	614870
Soft vakuumsalt blok, ks á 4x2,5 kg., 910 kg. pr. pl.	6273	6082	6012	5955	5932	5810	614960

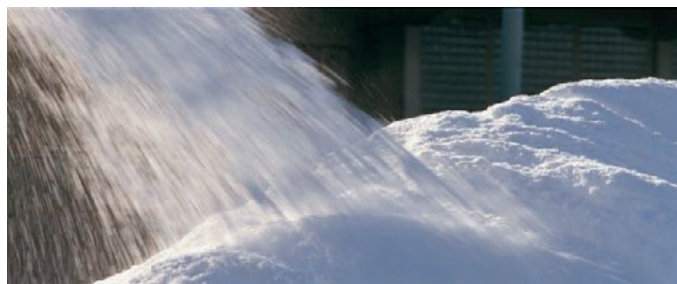

Stål

Priser ab værk. Fragtfrit leveret ved køb min. 3000,- ex. moms. Ved køb under 3000,-, tillæg 550,- ex. moms.							
Kamstål i dansk udførelse - i anbrud. DS/EN10080, B550							
Varenummer	Diameter	Længde	kg/mtr.	kr/kg	kr/kg	kr/kg	kr/kg
				0-500 kg	501-1000kg	1001-2000 kg	2001-4000kg
41420986	Y 6mm	6 mtr.	0,23	15,62	12,95	10,70	10,53
41420996	Y 8mm	6 mtr.	0,41	12,86	10,01	8,28	7,94
41420997	Y 8mm	12 mtr.	0,41	12,60	9,50	7,94	7,68
41420998	Y 10mm	6 mtr.	0,64	12,33	9,50	7,77	7,25
41420999	Y 10mm	12 mtr.	0,64	12,17	9,15	7,43	6,39
41421000	Y 12mm	6 mtr.	0,92	12,17	9,15	7,43	6,39
41421001	Y 12mm	12 mtr.	0,92	12,08	9,15	7,43	6,39
41421003	Y 14mm	12 mtr.	1,24	12,08	9,15	7,43	6,39
41421005	Y 16mm	6 mtr.	1,63	12,08	9,15	7,43	6,39
41421005x	Y 16mm	12 mtr.	1,63	12,08	9,15	7,43	6,39
41421006	Y 20mm	6 mtr.	2,54	12,08	9,15	7,43	6,39
41421009	Y 20mm	12 mtr.	2,54	12,08	9,15	7,43	6,39
41421011	Y 25mm	12 mtr.	3,97	12,08	9,15	7,43	6,39
41612262	Y 32mm	12 mtr.	6,52	12,08	9,15	7,43	6,39
Kamstål i tysk udførelse - i anbrud. Bst 500,. DIN 488							
Varenummer	Diameter	Længde	kg/mtr.	kr/kg	kr/kg	kr/kg	kr/kg
				0-500 kg	501-1000kg	1001-2000 kg	2001-4000kg
41421012	Ø6	6 mtr.	0,23	11,64	9,50	8,97	8,28
41421020	Ø8	6 mtr.	0,40	11,13	8,63	8,03	7,25
41421021	Ø8	12 mtr.	0,40	11,13	8,63	8,03	7,25
41421022	Ø10	6 mtr.	0,62	10,79	7,94	6,90	6,21
41421023	Ø10	12 mtr.	0,62	10,79	7,94	6,90	6,21
41421028	Ø12	6 mtr.	0,89	10,79	7,94	6,90	6,21
41421029	Ø12	12 mtr.	0,89	10,79	7,94	6,90	6,21
41421030	Ø14	6 mtr.	1,21	10,79	7,94	6,90	6,21
41421030	Ø14	12 mtr.	1,21	10,79	7,94	6,90	6,21
41421031	Ø16	6 mtr.	1,58	10,79	7,94	6,90	6,21
41421031x	Ø16	12 mtr.	1,58	10,79	7,94	6,90	6,21
41421033	Ø20	12 mtr.	2,48	10,79	7,94	6,90	6,21



Svejste armeringsnet i DIN 488, tysk Bst 500							
Varenummer	Størrelse	m2	kg/stk.	kr/kg	kr/kg	kr/kg	kr/kg
				0-500 kg	501-1000kg	1001-2000 kg	2001-4000kg
41420976	2500x2150x150x4	5,375	7,3	12,77	9,50	8,81	8,28
41420983	2500x1500x150x4	3,75	5,1	11,22	9,50	8,97	8,28
41420979	2500x2150x150x6	5,375	16,44	11,22	8,97	8,28	7,43
41420977	5000x2150x150x4	10,75	14,5	12,42	9,66	8,97	8,63
41420980	5000x2150x150x6	10,75	32,4	11,22	8,12	7,43	6,90
41420982	5000x2150x150x8	10,75	57,85	11,22	8,12	7,43	6,90
Svejste armeringsnet i DS/EN10080							
41605610	5000x2350x100x5	11,75	36,6	11,22	8,63	7,77	7,43
41420800	5000x2350x100x6	11,75	52,75	11,22	8,63	7,77	7,43
41420853	5000x2350x100x8	11,75	93,82	11,22	8,63	7,77	7,43
41420856	5000x2350x100x10	11,75	146,55	11,22	8,63	7,77	7,43
41420891	5000x2350x100x12	11,75	210,95	11,22	8,63	7,77	7,43
41605226	2500x1500x150x6	3,75	11,35	11,22	8,63	7,77	7,43
41605228	2500x1500x150x8	3,75	20,18	11,22	8,63	7,77	7,43
41605232	2500x1500x150x10	3,75	31,6	11,22	8,63	7,77	7,43
41420894	5000x2350x150x5	11,75	24,4	11,22	8,63	7,77	7,43
41420910	5000x2350x150x6	11,75	35,5	11,22	8,63	7,77	7,43
41420954	5000x2350x150x8	11,75	63,2	11,22	8,63	7,77	7,43
41420955	5000x2350x150x10	11,75	98,7	11,22	8,63	7,77	7,43
41420956	5000x2350x150x12	11,75	141,9	11,22	8,63	7,77	7,43
41420957	5000x2350x200x5	11,75	18,3	11,22	8,63	7,77	7,43
41420958	5000x2350x200x6	11,75	26,4	11,22	8,63	7,77	7,43
41420960	5000x2350x200x8	11,75	46,9	11,22	8,63	7,77	7,43
41420962	500x2350x200x10	11,75	73,3	11,22	8,63	7,77	7,43

Svejste stødzonenet DS/EN10080							
Varenummer	Størrelse	m2	kg/stk.	kr/kg	kr/kg	kr/kg	kr/kg
				0-500 kg	501-1000kg	1001-2000 kg	2001-4000kg
41489062	5000x2350x100x6	11,75	47,48	11,39	8,63	7,77	7,43
41489063	5000x2350x100x8	11,75	79,55	11,39	8,63	7,77	7,43
41605240	5000x2350x100x10	11,75	117	11,39	8,63	7,77	7,43
41605241	5000x2350x100x12	11,75	166	11,39	8,63	7,77	7,43
41420967	5000x2350x150x6	11,75	30,3	11,39	8,63	7,77	7,43
41420969	5000x2350x150x8	11,75	52,2	11,39	8,63	7,77	7,43
41420970	5000x2350x150x10	11,75	79,25	11,39	8,63	7,77	7,43
41420971	5000x2350x150x12	11,75	109,55	11,39	8,63	7,77	7,43
41420972	5000x2350x200x8	11,75	39,5	11,39	8,63	7,77	7,43
41420973	5000x2350x200x10	11,75	59,85	11,39	8,63	7,77	7,43
41420965	5000x2350x200x12	11,75	85,87	11,39	8,63	7,77	7,43

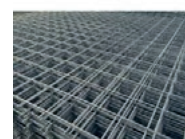

Svejste armeringsnet i galvaniseret udførelse, Bst 500						
Varenummer	Størrelse mm.	m2	kg/stk.	kr/stk	kr/stk	
				50 stk.	100 stk.	
41470462	1800x900x150x6	1,62	5,15	138,00	113,85	
41420984	2500x1500x150x6	3,75	11,30	272,55	227,70	

Rf. Kamstål, i lgd. Á 3 & 6 meter						
Varenummer	Størrelse	Længde	kg/mtr.	kr/kg	kr/mtr.	
41421165	Kamstål 6mm	3 mtr	0,233	60,38	14,06	
41421165x	Kamstål 6mm	6 mtr	0,233	60,38	14,06	
41421166	Kamstål 8mm	6 mtr	0,41	60,38	24,75	
41421167	Kamstål 10mm	6 mtr	0,64	60,38	38,64	
41421168	Kamstål 12mm	6 mtr	0,92	60,38	55,55	
41421169	Kamstål 16mm	6 mtr	1,63	60,38	98,40	

Bjælker kvalitet S 235 JR.						
Varenummer	Størrelse	Længde	kg/mtr	kr/kg	kr/mtr	
41421034	HEB 100	12 mtr	20,40	9,48	219,93	
41421040	HEB 120	12 mtr	26,70	9,48	253,32	
41421042	HEB 140	12 mtr	33,70	9,48	319,73	
41421043	HEB 160	12 mtr	42,60	9,48	404,18	
41421049	HEB 180	12 mtr	51,20	9,48	485,76	
41421050	HEB 200	12 mtr	61,30	9,48	581,58	
41421051	HEB 220	12 mtr	71,50	9,48	678,36	
41421052	HEB 240	12 mtr	83,20	9,48	789,36	
41421053	HEB 260	12 mtr	93,00	9,48	882,35	
41421055	HEB 280	12 mtr	103,00	9,48	977,22	
41421056	HEB 300	12 mtr	117,00	9,48	1110,05	
41421074	IPE 100	12 mtr	8,10	9,48	76,85	
41421075	IPE 120	12 mtr	10,40	9,48	98,67	
41421076	IPE 140	12 mtr	12,90	9,48	122,39	
41421077	IPE 160	12 mtr	15,80	9,48	149,91	
41421077x	IPE 180	12 mtr	18,80	9,48	178,37	
41421079	IPE 200	12 mtr	22,40	9,48	212,52	
41421080	IPE 220	12 mtr	26,20	9,48	248,58	
41421081	IPE 240	12 mtr	30,70	9,48	291,27	
41606101	IPE 270	12 mtr	36,10	9,48	342,50	
41606103	IPE 300	12 mtr	42,20	9,48	400,38	



Bjælker i galvaniseret udførelse (saves ikke)						
Varenummer	Størrelse	Længde	kg/mtr.	kr/kg.	kr/mtr.	
		meter				
41469661	HEB 100	4	21,8	14,66	319,65	
41469671	HEB 100	7	21,8	14,66	319,65	
41469666	HEB 120	4	28,6	14,66	419,36	
41469668	HEB 120	7	28,6	14,66	419,36	

U-stål sort udførelse (saves ikke)						
Varenummer	Størrelse	Længde	kg/mtr.	kr/kg.	kr/mtr.	
		meter				
41606104	Ustål nr. 40	6	4,87	11,21	54,60	
41606105	Ustål nr. 50	6	5,59	11,21	62,69	
41433983	Ustål nr. 65	6	7,09	11,21	79,50	

Afstandsholdere til armering						
Varenummer	Antal stk.	Størrelse	kr/stk.			
41421117	500	15/20 mm	1,73			
41421118	500	25/30 mm	2,42			
41421119	500	40/50 mm	2,85			
41421120	500	50/60 mm	3,36			
41421123	500	70/80 mm	4,14			

Al-lister til armering						
Varenummer	Antal mtr.	Størrelse	kr/mtr.			
41421152	100	15 mm	4,74			
41421152x	4200	15 mm	3,45			
41421143	100	20 mm	4,02			
41421143x	4800	20 mm	3,23			
41421152	100	25 mm	5,09			
41421152x	4200	25 mm	3,80			
41421154	100	30 mm	4,74			
41421154x	3600	30 mm	4,05			
41421155	60	35 mm	6,47			
41421155x	2880	35 mm	5,27			
41421156	60	40 mm	7,25			
41421156x	2400	40 mm	6,39			
41421158	60	50 mm	7,77			
41421158x	1440	50 mm	7,25			



Distans - afstandsholdere ml. netlag							
Varenummer	Antal mtr.	Størrelse	kr/mtr.				
	Pakning	mm					
41421126	50	50	5,52				
41421126x	2400	50	4,97				
41421130	50	60	5,70				
414211230x	1800	60	5,21				
41421131	50	70	5,96				
41421131x	1800	70	5,36				
41421134	50	80	6,05				
41421134x	1800	80	5,40				
41421136	50	90	6,21				
41421136x	1800	90	5,55				
41421135	50	100	6,39				
41421135x	1800	100	5,73				
41421136	50	110	6,56				
41421136x	1800	110	5,79				
41421138	50	120	7,08				
41421138x	1800	120	6,09				
41421139	50	130	7,43				
41421139x	1800	130	6,45				
41421140	50	140	7,59				
41421140x	1800	140	6,80				



Priser vedr. herregårdssten, havefliser, støttemursten, luksus fliser samt granit, er frit leveret v/5 hele paller.

Obs! man kan ikke kombinere granit og beton

Tillæg pr. palle u/5 hele paller kr. 150,-

Tillæg u/2 hele paller 1 x 477,-, + 150,- pr. pl.

Tillæg for palle (engangspalle, hvis ikke der ønskes returpaller)

PALLER:

faktureres til:

Engangspaller			9701	150
EUR paller, retur			9702	150
EUR pallerammer			9702R	120

Afh. min. 17 stk. + fragt

Krediteres til:

Engangspaller	60		9701	
EUR paller, retur	60		9702	
EUR pallerammer,	40		9702R	



Fragt-distributionsrater fra egne lagre. Pris pr. pl.

		Jylland	Sjælland
0-2 paller		525	630
3-4 paller		399	495
5-10 paller		329	420
11-20 paller		278	330

Vedr. øvrig fragt, kontakt venligst
A-Supply for priser tlf. 72344404



A-Supply

HUS & HAVE Grossist

