



**Probes**  
**Compact models**  
**Amplifiers**





**Ex-Probe** | Device category 1G, 1G/2G und 1D

**Ex**-Device category 1G  
Installation in Zone 0 (gas)

**Ex**-Device category 1G/2G  
Installation in partition wall  
Zone 0 / Zone 1 (gas)

**Ex**-Device category 1D  
Installation in Zone 20 (dust)



Design	G1/4	G1/2	G1/2	NPT1/2	G3/4
<b>Dimensions</b>					
Detection range [cm/s]	water 1...100 / oil 3...200				
Sensor length [mm]	25	31	48	40	48
Connection	plug	plug	plug	plug	plug
ID-No.	P11164	P11165	P11166	P11167	P11169
Type	STS 101 S	STS 102 S	STS 103 S	STS 104 S	STS 106 S
Ex area of use	Gas: Zone 0, Partition wall Zone 0 / Zone 1 / Dust: Zone 20				
Certificate No.	TÜV 98 ATEX 1298 X				
Ex marking	Gas: $\text{Ex II 1 G Ex ia IIC T6...T3 Ga}$ $\text{Ex II 1/2 G Ex ia IIC T6...T3 Ga/Gb}$ Dust: $\text{Ex II 1 D Ex ia IIIC T125 °C Da}$				
Ambient temperature and medium temperature [°C]	Gas: T6: $-20 \leq T_a \leq +40$ T5: $-20 \leq T_a \leq +55$ T4: $-20 \leq T_a \leq +85$ T3: $-20 \leq T_a \leq +85$ Dust: $-20 \leq T_a \leq +85$				
Maximum values	$U_i = 13.65 \text{ V}$ / $I_i = 200 \text{ mA}$ / $P_i = 0.69 \text{ W}$ / $C_i = 0.27 \text{ nF}$ / $L_i = 1.30 \text{ }\mu\text{H}$				
Start-up time typ. [s]	8 (2...18)				
Reaction time typ. [s]	2 (1...13)				
Compressive strength [bar]	60				
Housing material	AISI 316 Ti • different materials on request				
Protection [EN 60529]	IP 67				
Connection	M12 connector				
Note:	Observe specific conditions for use in section "Technique and application" on page 1.13 for the connection to amplifier SZAb..., page 1.104-1.105				



**Ex-Probe** | Device category 1G, 1G/2G und 1D

**Ex**-Device category 1G  
Installation in Zone 0 (gas)

**Ex**-Device category 1G/2G  
Installation in partition wall  
Zone 0 / Zone 1 (gas)

**Ex**-Device category 1D  
Installation in Zone 20 (dust)



Design	G1/4	G1/2	G1/2	NPT1/2	G3/4
<b>Dimensions</b>					
Detection range [cm/s]	water 1...100 / oil 3...200				
Sensor length [mm]	25	31	48	40	48
Connection	fixed cable	fixed cable	fixed cable	fixed cable	fixed cable
ID-No.	P11140	P11141	P11142	P11143	P11168
Type	STS 101 K	STS 102 K	STS 103 K	STS 104 K	STS 106 K
Ex area of use	Gas: Zone 0, Partition wall Zone 0 / Zone 1 / Dust: Zone 20				
Certificate No.	TÜV 98 ATEX 1298 X				
Ex marking	Gas: <b>Ex</b> II 1 G Ex ia IIC T6...T3 Ga <b>Ex</b> II 1/2 G Ex ia IIC T6...T3 Ga/Gb Dust: <b>Ex</b> II 1 D Ex ia IIIC T125 °C Da				
Ambient temperature and medium temperature [°C]	Gas: T6: -20 ≤ Ta ≤ +40 T5: -20 ≤ Ta ≤ +55 T4: -20 ≤ Ta ≤ +85 T3: -20 ≤ Ta ≤ +85 Dust: -20 ≤ Ta ≤ +85				
Maximum values	Ui = 13.65 V / li = 200 mA / Pi = 0.69 W / Ci = 0.27 nF / Li = 1.30 µH				
Start-up time typ. [s]	8 (2...18)				
Reaction time typ. [s]	2 (1...13)				
Compressive strength [bar]	60				
Housing material	AISI 316 Ti • different materials on request				
Protection [EN 60529]	IP 67				
Connection	2 m PUR-cable 4x0.25 mm <sup>2</sup>				



Observe specific conditions for use in section "Technique and application" on page 1.13

Note: for the connection to amplifier SZAb..., page 1.104-1.105



**Ex-Probe** | Device category 1G, 1G/2G und 1D

**Ex**-Device category 1G  
Installation in Zone 0 (gas)

**Ex**-Device category 1G/2G  
Installation in partition wall  
Zone 0 / Zone 1 (gas)

**Ex**-Device category 1D  
Installation in Zone 20 (dust)



Extended temperature range  
up to 120 °C

Design	G1/4	G1/2	G1/2	NPT1/2	G3/4
<b>Dimensions</b>					
Detection range [cm/s]	water 1...100 / oil 3...200				
Sensor length [mm]	25	31	48	40	48
Connection	fixed cable	fixed cable	fixed cable	fixed cable	fixed cable
ID-No.	P11409	P11410	P11411	P11412	P11413
Type	STS 101 KH	STS 102 KH	STS 103 KH	STS 104 KH	STS 106 KH
Ex area of use	Gas: Zone 0, Partition wall Zone 0 / Zone 1 / Dust: Zone 20				
Certificate No.	TÜV 98 ATEX 1298 X				
Ex marking	Gas: <b>Ex</b> II 1 G Ex ia IIC T6...T3 Ga <b>Ex</b> II 1/2 G Ex ia IIC T6...T3 Ga/Gb Dust: <b>Ex</b> II 1 D Ex ia IIIC T125 °C Da				
Ambient temperature [°C] and medium temperature	Gas: T6: +10 ≤ Ta ≤ +40 T5: +10 ≤ Ta ≤ +55 T4: +10 ≤ Ta ≤ +90 T3: +10 ≤ Ta ≤ +120 Dust: -20 ≤ Ta ≤ +85				
Maximum values	Ui = 13.65 V / li = 200 mA / Pi = 0.69 W / Ci = 0.27 nF / Li = 1.30 µH				
Start-up time typ. [s]	8 (2...18)				
Reaction time typ. [s]	2 (1...13)				
Compressive strength [bar]	60				
Housing material	AISI 316 Ti • different materials on request				
Protection [EN 60529]	IP 67				
Connection	2 m FEP-cable 4x0.25 mm <sup>2</sup>				

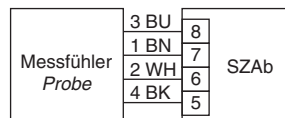

Observe specific conditions for use in section "Technique and application" on page 1.13

**Note:** for the connection to amplifier SZAb..., page 1.104-1.105



**Ex-Probe** | Device category 2G and 2D

**Ex-Device category 2G**  
Installation in Zone 1 (gas)

**Ex-Device category 2D**  
Installation in Zone 21 (dust)



Design	G1/4	G1/2	G1/2	NPT1/2	G3/4
<b>Dimensions</b>					
Detection range [cm/s]	water 1...100 / oil 3...200				
Sensor length [mm]	25	31	48	40	48
Connection	plug	plug	plug	plug	plug
ID-No.	P11170	P11171	P11172	P11173	P11175
Type	ST 101 S	ST 102 S	ST 103 S	ST 104 S	ST 106 S
Ex area of use	Gas: Zone 1 / Dust: Zone 21				
Certificate No.	TÜV 97 ATEX 1218				
Ex marking	Gas: <b>Ex</b> II 2 G Ex ib IIC T6 Gb Dust: <b>Ex</b> II 2 D Ex ib IIIC T125 °C Db				
Ambient temperature and medium temperature [°C]	Gas: T6: -20 ≤ Ta ≤ +40 T5: -20 ≤ Ta ≤ +55 T4: -20 ≤ Ta ≤ +85 T3: -20 ≤ Ta ≤ +85 Dust: -20 ≤ Ta ≤ +85				
Maximum values	Ui = 13.65 V / li = 200 mA / Pi = 0.69 W / Ci = 0.27 nF / Li = 1.30 µH				
Start-up time typ. [s]	8 (2...18)				
Reaction time typ. [s]	2 (1...13)				
Compressive strength [bar]	60				
Housing material	AISI 316 Ti • different materials on request				
Protection [EN 60529]	IP 67				
Connection	M12 connector				
Note:	(probes with cable length > 2 m are available on request) for the connection to amplifier SZAb..., page 1.104-1.105				



**Ex-Probe** | Device category 2G and 2D

**Ex**-Device category 2G  
Installation in Zone 1 (gas)

**Ex**-Device category 2D  
Installation in Zone 21 (dust)



Design	G1/4	G1/2	G1/2	NPT1/2	G3/4
<b>Dimensions</b>					
Detection range [cm/s]	water 1...100 / oil 3...200				
Sensor length [mm]	25	31	48	40	48
Connection	fixed cable	fixed cable	fixed cable	fixed cable	fixed cable
ID-No.	P11144	P11145	P11146	P11147	P11174
Type	ST 101 K	ST 102 K	ST 103 K	ST 104 K	ST 106 K
Ex area of use	Gas: Zone 1 / Dust: Zone 21				
Certificate No.	TÜV 97 ATEX 1218				
Ex marking	Gas: <b>Ex</b> II 2 G Ex ib IIC T6 Gb Dust: <b>Ex</b> II 2 D Ex ib IIIC T125 °C Db				
Ambient temperature and medium temperature [°C]	Gas: T6: -20 ≤ Ta ≤ +40 T5: -20 ≤ Ta ≤ +55 T4: -20 ≤ Ta ≤ +85 T3: -20 ≤ Ta ≤ +85 Dust: -20 ≤ Ta ≤ +85				
Maximum values	Ui = 13.65 V / li = 200 mA / Pi = 0.69 W / Ci = 0.27 nF / Li = 1.30 µH				
Start-up time typ. [s]	8 (2...18)				
Reaction time typ. [s]	2 (1...13)				
Compressive strength [bar]	60				
Housing material	AISI 316 Ti • different materials on request				
Protection [EN 60529]	IP 67				
Connection	2 m PUR-cable 4x0.25 mm <sup>2</sup>				

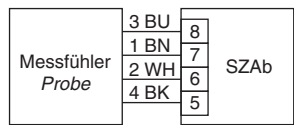

(probes with cable length > 2 m are available on request)

**Note:** for the connection to amplifier SZAb..., page 1.104-1.105





**Ex-Probe** | Device category 2G and 2D

**Ex**-Device category 2G  
Installation in Zone 1 (gas)

**Ex**-Device category 2D  
Installation in Zone 21 (dust)

Extended temperature range  
up to 120 °C



Design	G1/4	G1/2	G1/2	NPT1/2	G3/4										
<b>Dimensions</b>															
Detection range [cm/s]	water 1...100 / oil 3...200														
Sensor length [mm]	25	31	48	40	48										
Connection	fixed cable	fixed cable	fixed cable	fixed cable	fixed cable										
ID-No.	P11176	P11178	P11180	P11182	P11184										
Type	ST 101 KH	ST 102 KH	ST 103 KH	ST 104 KH	ST 106 KH										
Ex area of use	Gas: Zone 1 / Dust: Zone 21														
Certificate No.	TÜV 97 ATEX 1218														
Ex marking	Gas: <b>Ex</b> II 2 G Ex ib IIC T6 Gb Dust: <b>Ex</b> II 2 D Ex ib IIIC T125 °C Db														
Ambient temperature and medium temperature [°C]	Gas: T6: +10 ≤ Ta ≤ +40 T5: +10 ≤ Ta ≤ +55 T4: +10 ≤ Ta ≤ +90 T3: +10 ≤ Ta ≤ +120 Dust: -20 ≤ Ta ≤ +85														
Maximum values	Ui = 13.65 V / li = 200 mA / Pi = 0.69 W / Ci = 0.27 nF / Li = 1.30 µH														
Start-up time typ. [s]	8 (2...18)														
Reaction time typ. [s]	2 (1...13)														
Compressive strength [bar]	60														
Housing material	AISI 316 Ti • different materials on request														
Protection [EN 60529]	IP 67														
Connection	2 m FEP-cable 4x0.25 mm <sup>2</sup>														
	<table border="1" style="margin-left: auto; margin-right: auto;"> <tr> <td rowspan="4" style="text-align: center;">Messfühler Probe</td> <td>3 BU</td> <td>8</td> <td rowspan="4" style="text-align: center;">SZAb</td> </tr> <tr> <td>1 BN</td> <td>7</td> </tr> <tr> <td>2 WH</td> <td>6</td> </tr> <tr> <td>4 BK</td> <td>5</td> </tr> </table>					Messfühler Probe	3 BU	8	SZAb	1 BN	7	2 WH	6	4 BK	5
Messfühler Probe	3 BU	8	SZAb												
	1 BN	7													
	2 WH	6													
	4 BK	5													
Note:	(probes with cable length > 2 m are available on request) for the connection to amplifier SZAb..., page 1.104-1.105														



**Ex-Probe** | Device category 1G, 1G/2G and 1D

**Ex**-Device category 1G  
Installation in Zone 0 (gas)

**Ex**-Device category 1G/2G  
Installation in partition wall  
Zone 0 / Zone 1 (gas)

**Ex**-Device category 1D  
Installation in Zone 20 (dust)



Design	G1/2				
<b>Dimensions</b>					
<b>Detection range</b>	[cm/s] water 1...100 / oil 3...200				
<b>Sensor length L</b>	48	48	80	110	140
<b>Connection</b>	fixed cable	plug	fixed cable	fixed cable	fixed cable
<b>ID-No.</b>	P11186	P11187	P11188	P11189	P11190
<b>Type</b>	STS 110 K	STS 110 S	STS 110 K-L80	STS 110 K-L110	STS 110 K-L140
<b>Ex area of use</b>	Gas: Zone 0, Partition wall Zone 0 / Zone 1 / Dust: Zone 20				
<b>Certificate No.</b>	TÜV 98 ATEX 1298 X				
<b>Ex marking</b>	Gas: <b>Ex</b> II 1 G Ex ia IIC T6...T3 Ga <b>Ex</b> II 1/2 G Ex ia IIC T6...T3 Ga/Gb Dust: <b>Ex</b> II 1 D Ex ia IIIC T125 °C Da				
<b>Ambient temperature and medium temperature</b>	Gas: T6: -20 ≤ Ta ≤ +40 T5: -20 ≤ Ta ≤ +55 T4: -20 ≤ Ta ≤ +85 T3: -20 ≤ Ta ≤ +85 Dust: -20 ≤ Ta ≤ +85				
<b>Maximum values</b>	Ui = 13.65 V / li = 200 mA / Pi = 0.69 W / Ci = 0.27 nF / Li = 1.30 μH				
<b>Start-up time typ.</b>	[s] 8 (2...18)				
<b>Reaction time typ.</b>	[s] 2 (1...13)				
<b>Compressive strength</b>	[bar] 60				
<b>Housing material</b>	AISI 316 Ti • different materials on request				
<b>Protection</b>	[EN 60529] IP 67				
<b>Connection</b>	...K: 2 m PUR-cable 4x0.25 mm <sup>2</sup> ...S: M12 connector				
<b>Note:</b>	for the connection to amplifier SZAb..., page 1.104-1.105				

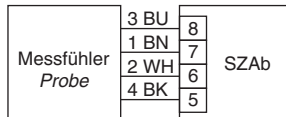
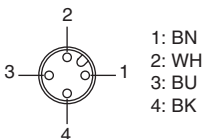

Observe specific conditions for use in section "Technique and application" on page 1.13





**Ex-Probe** | Device category 1G, 1G/2G and 1D

**Ex**-Device category 1G  
Installation in Zone 0 (gas)

**Ex**-Device category 1G/2G  
Installation in partition wall  
Zone 0 / Zone 1 (gas)

**Ex**-Device category 1D  
Installation in Zone 20 (dust)

Extended temperature range up to 120 °C



Design	G1/2				
<b>Dimensions</b>					
Detection range	[cm/s]	water 1...100 / oil 3...200			
Sensor length L	[mm]	48	80	110	140
Connection		fixed cable	fixed cable	fixed cable	fixed cable
ID-No.		P11414	P11415	P11416	P11417
Type		STS 110 KH	STS 110 KH-L80	STS 110 KH-L110	STS 110 KH-L140
Ex area of use		Gas: Zone 0, Partition wall Zone 0 / Zone 1 / Dust: Zone 20			
Certificate No.		TÜV 98 ATEX 1298 X			
Ex marking		Gas: <b>Ex</b> II 1 G Ex ia IIC T6...T3 Ga <b>Ex</b> II 1/2 G Ex ia IIC T6...T3 Ga/Gb Dust: <b>Ex</b> II 1 D Ex ia IIIC T125 °C Da			
Ambient temperature and medium temperature	[°C]	Gas: T6: +10 ≤ Ta ≤ +40 T5: +10 ≤ Ta ≤ +55 T4: +10 ≤ Ta ≤ +90 T3: +10 ≤ Ta ≤ +120 Dust: -20 ≤ Ta ≤ +85			
Maximum values		Ui = 13.65 V / li = 200 mA / Pi = 0.69 W / Ci = 0.27 nF / Li = 1.30 µH			
Start-up time typ.	[s]	8 (2...18)			
Reaction time typ.	[s]	2 (1...13)			
Compressive strength	[bar]	60			
Housing material		AISI 316 Ti • different materials on request			
Protection	[EN 60529]	IP 67			
Connection		2 m FEP-cable 4x0.25 mm <sup>2</sup>			
		Observe specific conditions for use in section "Technique and application" on page 1.13			
Note:		for the connection to amplifier SZAb..., page 1.104-1.105			



**Ex-Probe** | Device category 2G and 2D

**Ex**-Device category 2G  
Installation in Zone 1 (gas)

**Ex**-Device category 2D  
Installation in Zone 21 (dust)



Design	G1/2				
<b>Dimensions</b>					
<b>Detection range</b> [cm/s]	water 1...100 / oil 3...200				
<b>Sensor length L</b> [mm]	48	48	80	110	140
<b>Connection</b>	fixed cable	plug	fixed cable	fixed cable	fixed cable
<b>ID-No.</b>	P11192	P11193	P11194	P11195	P11196
<b>Type</b>	ST 110 K	ST 110 S	ST 110 K-L80	ST 110 K-L110	ST 110 K-L140
<b>Ex area of use</b>	Gas: Zone 1 / Dust: Zone 21				
<b>Certificate No.</b>	TÜV 97 ATEX 1218				
<b>Ex marking</b>	Gas: <b>Ex</b> II 2 G Ex ib IIC T6 Gb Dust: <b>Ex</b> II 2 D Ex ib IIIC T125 °C Db				
<b>Ambient temperature and medium temperature</b> [°C]	Gas: T6: -20 ≤ Ta ≤ +40 T5: -20 ≤ Ta ≤ +55 T4: -20 ≤ Ta ≤ +85 T3: -20 ≤ Ta ≤ +85 Dust: -20 ≤ Ta ≤ +85				
<b>Maximum values</b>	Ui = 13.65 V / Ii = 200 mA / Pi = 0.69 W / Ci = 0.27 nF / Li = 1.30 µH				
<b>Start-up time typ.</b> [s]	8 (2...18)				
<b>Reaction time typ.</b> [s]	2 (1...13)				
<b>Compressive strength</b> [bar]	60				
<b>Housing material</b>	AISI 316 Ti • different materials on request				
<b>Protection</b> [EN 60529]	cable ...K: IP 67 / plug ...S: IP 67				
<b>Connection</b>	...K: 2 m PUR-cable 4x0.25 mm² / ...S: M12 connector				
<b>Note:</b>	(probes with cable length > 2 m are available on request) for the connection to amplifier SZAb..., page 1.104-1.105				



**Ex-Probe** | Device category 2G and 2D

**Ex**-Device category 2G  
Installation in Zone 1 (gas)

**Ex**-Device category 2D  
Installation in Zone 21 (dust)

Extended temperature range  
up to 120 °C



Design	G1/2													
<b>Dimensions</b>														
<b>Detection range</b> [cm/s]	water 1...100 / oil 3...200													
<b>Sensor length L</b> [mm]	48	80	110	140										
<b>Connection</b>	fixed cable	fixed cable	fixed cable	fixed cable										
<b>ID-No.</b>	P11198	P11200	P11201	P11202										
<b>Type</b>	ST 110 KH	ST 110 KH-L80	ST 110 KH-L110	ST 110 KH-L140										
<b>Ex area of use</b>	Gas: Zone 1 / Dust: Zone 21													
<b>Certificate No.</b>	TÜV 97 ATEX 1218													
<b>Ex marking</b>	Gas: <b>Ex</b> II 2 G Ex ib IIC T6 Gb Dust: <b>Ex</b> II 2 D Ex ib IIIC T125 °C Db													
<b>Ambient temperature and medium temperature</b> [°C]	Gas: T6: +10 ≤ Ta ≤ +40 T5: +10 ≤ Ta ≤ +55 T4: +10 ≤ Ta ≤ +90 T3: +10 ≤ Ta ≤ +120 Dust: -20 ≤ Ta ≤ +85													
<b>Maximum values</b>	U <sub>i</sub> = 13.65 V / I <sub>i</sub> = 200 mA / P <sub>i</sub> = 0.69 W / C <sub>i</sub> = 0.27 nF / L <sub>i</sub> = 1.30 µH													
<b>Start-up time typ.</b> [s]	8 (2...18)													
<b>Reaction time typ.</b> [s]	2 (1...13)													
<b>Compressive strength</b> [bar]	60													
<b>Housing material</b>	AISI 316 Ti • different materials on request													
<b>Protection</b> [EN 60529]	IP 67													
<b>Connection</b>	2 m FEP-cable 4x0.25 mm <sup>2</sup>													
<table border="1" style="margin: auto;"> <tr> <td rowspan="4" style="padding: 5px;">Messfühler Probe</td> <td style="padding: 2px 5px;">3 BU</td> <td style="padding: 2px 5px;">8</td> <td rowspan="4" style="padding: 5px;">SZAb</td> </tr> <tr> <td style="padding: 2px 5px;">1 BN</td> <td style="padding: 2px 5px;">7</td> </tr> <tr> <td style="padding: 2px 5px;">2 WH</td> <td style="padding: 2px 5px;">6</td> </tr> <tr> <td style="padding: 2px 5px;">4 BK</td> <td style="padding: 2px 5px;">5</td> </tr> </table> <p>(probes with cable length &gt; 2 m are available on request)</p>					Messfühler Probe	3 BU	8	SZAb	1 BN	7	2 WH	6	4 BK	5
Messfühler Probe	3 BU	8	SZAb											
	1 BN	7												
	2 WH	6												
	4 BK	5												
<b>Note:</b>	for the connection to amplifier SZAb..., page 1.104-1.105													



**Ex-Probe** | Device category 1G, 1G/2G and 1D

**Ex**-Device category 1G  
Installation in Zone 0 (gas)

**Ex**-Device category 1G/2G  
Installation in partition wall  
Zone 0 / Zone 1 (gas)

**Ex**-Device category 1D  
Installation in Zone 20 (dust)

With welded standard flange



**Design** **DN25 / PN40 (EN 1092-1/05 A)**

**Dimensions**

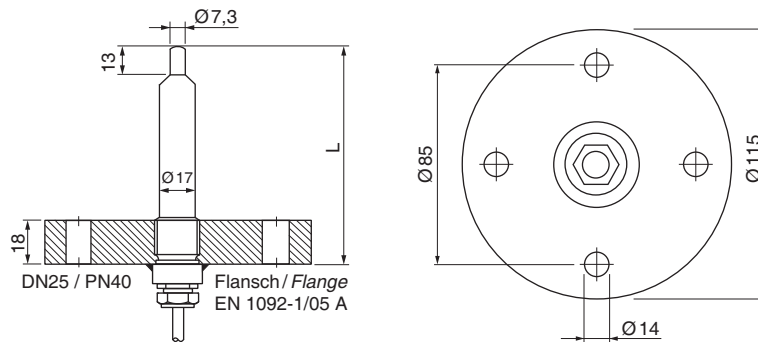

<b>Detection range</b> [cm/s]	water 1...100 / oil 3...200		
<b>Sensor length L</b> [mm]	80	110	140
<b>Connection</b>	fixed cable	fixed cable	fixed cable
<b>ID-No.</b>	P11191	P11148	P11149
<b>Type</b>	STS 111 K-L80	STS 111 K-L110	STS 111 K-L140
<b>Ex area of use</b>	Gas: Zone 0, Partition wall Zone 0 / Zone 1 / Dust: Zone 20		
<b>Certificate No.</b>	TÜV 98 ATEX 1298 X		
<b>Ex marking</b>	Gas: <b>Ex</b> II 1 G Ex ia IIC T6...T3 Ga <b>Ex</b> II 1/2 G Ex ia IIC T6...T3 Ga/Gb Dust: <b>Ex</b> II 1 D Ex ia IIIC T125 °C Da		
<b>Ambient temperature and medium temperature</b> [°C]	Gas: T6: -20 ≤ Ta ≤ +40 T5: -20 ≤ Ta ≤ +55 T4: -20 ≤ Ta ≤ +85 T3: -20 ≤ Ta ≤ +85 Dust: -20 ≤ Ta ≤ +85		
<b>Maximum values</b>	Ui = 13.65 V / li = 200 mA / Pi = 0.69 W / Ci = 0.27 nF / Li = 1.30 µH		
<b>Start-up time typ.</b> [s]	8 (2...18)		
<b>Reaction time typ.</b> [s]	2 (1...13)		
<b>Compressive strength</b> [bar]	probe: 60 / flange: PN40		
<b>Housing material</b>	AISI 316 Ti • different materials on request		
<b>Protection</b> [EN 60529]	IP 67		
<b>Connection</b>	2 m PUR-cable 4x0.25 mm <sup>2</sup>		

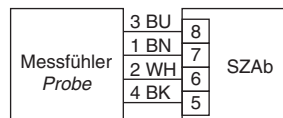

Observe specific conditions for use in section "Technique and application" on page 1.13

**Note:** for the connection to amplifier SZAb..., page 1.104-1.105



**Ex-Probe** | Device category 1G, 1G/2G and 1D

**Ex**-Device category 1G  
Installation in Zone 0 (gas)

**Ex**-Device category 1G/2G  
Installation in partition wall  
Zone 0 / Zone 1 (gas)

**Ex**-Device category 1D  
Installation in Zone 20 (dust)

With welded standard flange  
Extended temperature range up to 120 °C



**Design** **DN25 / PN40 (EN 1092-1/05 A)**

**Dimensions**

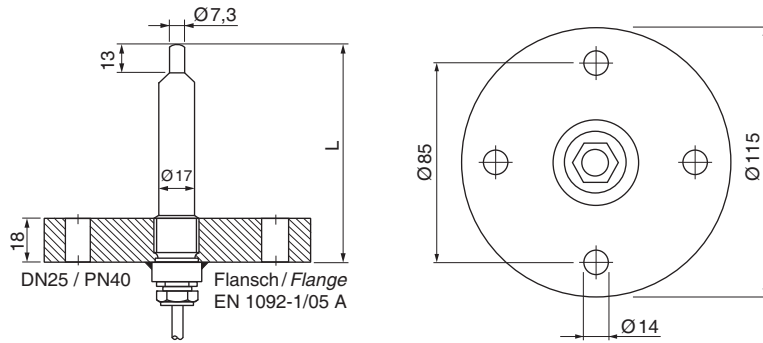

Detection range	[cm/s]	water 1...100 / oil 3...200		
Sensor length L	[mm]	80	110	140
Connection		fixed cable	fixed cable	fixed cable
ID-No.		P11418	P11419	P11420
Type		STS 111 KH-L80	STS 111 KH-L110	STS 111 KH-L140
Ex area of use		Gas: Zone 0, Partition wall Zone 0 / Zone 1 / Dust: Zone 20		
Certificate No.		TÜV 98 ATEX 1298 X		
Ex marking		Gas: <b>Ex</b> II 1 G Ex ia IIC T6...T3 Ga <b>Ex</b> II 1/2 G Ex ia IIC T6...T3 Ga/Gb Dust: <b>Ex</b> II 1 D Ex ia IIIC T125 °C Da		
Ambient temperature and medium temperature	[°C]	Gas: T6: +10 ≤ Ta ≤ +40 T5: +10 ≤ Ta ≤ +55 T4: +10 ≤ Ta ≤ +90 T3: +10 ≤ Ta ≤ +120 Dust: -20 ≤ Ta ≤ +85		
Maximum values		Ui = 13.65 V / li = 200 mA / Pi = 0.69 W / Ci = 0.27 nF / Li = 1.30 µH		
Start-up time typ.	[s]	8 (2...18)		
Reaction time typ.	[s]	2 (1...13)		
Compressive strength	[bar]	probe: 60 / flange: PN40		
Housing material		AISI 316 Ti • different materials on request		
Protection	[EN 60529]	IP 67		
Connection		2 m FEP-cable 4x0.25 mm <sup>2</sup>		

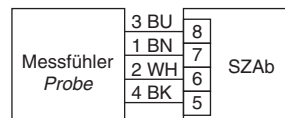

Observe specific conditions for use in section "Technique and application" on page 1.13

**Note:** for the connection to amplifier SZAb..., page 1.104-1.105



**Ex-Probe** | Device category 2G and 2D

**Ex**-Device category 2G  
Installation in Zone 1 (gas)

**Ex**-Device category 2D  
Installation in Zone 21 (dust)

With welded standard flange



**Design** **DN25 / PN40 (EN 1092-1/05 A)**

**Dimensions**

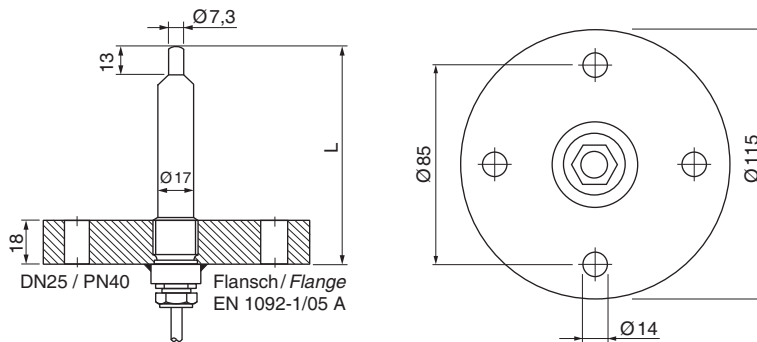

<b>Detection range</b>	[cm/s]	water 1...100 / oil 3...200		
<b>Sensor length L</b>	[mm]	80	110	140
<b>Connection</b>		fixed cable	fixed cable	fixed cable
<b>ID-No.</b>		P11197	P11150	P11151
<b>Type</b>		ST 111 K-L80	ST 111 K-L110	ST 111 K-L140
<b>Ex area of use</b>		Gas: Zone 1 / Dust: Zone 21		
<b>Certificate No.</b>		TÜV 97 ATEX 1218		
<b>Ex marking</b>		Gas:	Ex II 2 G Ex ib IIC T6 Gb	
		Dust:	Ex II 2 D Ex ib IIIC T125 °C Db	
<b>Ambient temperature and medium temperature</b>	[°C]	Gas:	T6: -20 ≤ Ta ≤ +40 T5: -20 ≤ Ta ≤ +55 T4: -20 ≤ Ta ≤ +85 T3: -20 ≤ Ta ≤ +85	
		Dust:	-20 ≤ Ta ≤ +85	
<b>Maximum values</b>		Ui = 13.65 V / li = 200 mA / Pi = 0.69 W / Ci = 0.27 nF / Li = 1.30 µH		
<b>Start-up time typ.</b>	[s]	8 (2...18)		
<b>Reaction time typ.</b>	[s]	2 (1...13)		
<b>Compressive strength</b>	[bar]	60		
<b>Housing material</b>		AISI 316 Ti • different materials on request		
<b>Protection</b>	[EN 60529]	IP 67		
<b>Connection</b>		2 m PUR-cable 4x0.25 mm²		



(probes with cable length > 2 m and different flanges are available on request)

**Note:** for the connection to amplifier SZAb..., page 1.104-1.105





**Ex-Probe** | Device category 2G and 2D

**Ex-Device category 2G**  
Installation in Zone 1 (gas)

**Ex-Device category 2D**  
Installation in Zone 21 (dust)

With welded standard flange

Extended temperature range up to 120 °C



Design	DN25 / PN40 (EN 1092-1/05 A)														
<b>Dimensions</b>															
<b>Detection range</b> [cm/s]	water 1...100 / oil 3...200														
<b>Sensor length L</b> [mm]	80	110	140												
<b>Connection</b>	fixed cable	fixed cable	fixed cable												
<b>ID-No.</b>	P11203	P11204	P11205												
<b>Type</b>	ST 111 KH-L80	ST 111 KH-L110	ST 111 KH-L140												
<b>Ex area of use</b>	Gas: Zone 1 / Dust: Zone 21														
<b>Certificate No.</b>	TÜV 97 ATEX 1218														
<b>Ex marking</b>	Gas: <b>Ex</b> II 2 G Ex ib IIC T6 Gb Dust: <b>Ex</b> II 2 D Ex ib IIIC T125 °C Db														
<b>Ambient temperature and medium temperature</b> [°C]	Gas: T6: +10 ≤ Ta ≤ +40 T5: +10 ≤ Ta ≤ +55 T4: +10 ≤ Ta ≤ +90 T3: +10 ≤ Ta ≤ +120 Dust: -20 ≤ Ta ≤ +85														
<b>Maximum values</b>	Ui = 13.65 V / li = 200 mA / Pi = 0.69 W / Ci = 0.27 nF / Li = 1.30 µH														
<b>Start-up time typ.</b> [s]	8 (2...18)														
<b>Reaction time typ.</b> [s]	2 (1...13)														
<b>Compressive strength</b> [bar]	60														
<b>Housing material</b>	AISI 316 Ti • different materials on request														
<b>Protection</b> [EN 60529]	IP 67														
<b>Connection</b>	2 m FEP-cable 4x0.25 mm <sup>2</sup>														
	<table border="1" style="margin: auto;"> <tr> <td rowspan="5" style="padding: 5px;">Messfühler Probe</td> <td style="padding: 2px;">3 BU</td> <td style="padding: 2px;">8</td> <td rowspan="5" style="padding: 5px;">SZAb</td> </tr> <tr> <td style="padding: 2px;">1 BN</td> <td style="padding: 2px;">7</td> </tr> <tr> <td style="padding: 2px;">2 WH</td> <td style="padding: 2px;">6</td> </tr> <tr> <td style="padding: 2px;">4 BK</td> <td style="padding: 2px;">5</td> </tr> <tr> <td style="padding: 2px;"></td> <td style="padding: 2px;"></td> </tr> </table>			Messfühler Probe	3 BU	8	SZAb	1 BN	7	2 WH	6	4 BK	5		
Messfühler Probe	3 BU	8	SZAb												
	1 BN	7													
	2 WH	6													
	4 BK	5													
	(probes with cable length > 2 m and different flanges are available on request)														
<b>Note:</b>	for the connection to amplifier SZAb..., page 1.104-1.105														



**Ex-Probe** | Device category 1G, 1G/2G and 1D

**Ex**-Device category 1G  
Installation in Zone 0 (gas)

**Ex**-Device category 1G/2G  
Installation in partition wall  
Zone 0 / Zone 1 (gas)

**Ex**-Device category 1D  
Installation in Zone 20 (dust)



Design	G3/4	NPT3/4
<b>Dimensions</b>		
Detection range [cm/s]	water 1...100 / oil 3...200	water 1...100 / oil 3...200
Sensor length [mm]	68	68
Connection	terminal clamps	terminal clamps
ID-No.	P11268	P11269
Type	STSEX 01	STSEX 02
Ex area of use	Gas: Zone 0, Partition wall Zone 0 / Zone 1 / Dust: Zone 20	
Certificate No.	TÜV 98 ATEX 1298 X	
Ex marking	Gas: <b>Ex</b> II 1 G Ex ia IIC T6...T3 Ga <b>Ex</b> II 1/2 G Ex ia IIC T6...T3 Ga/Gb Dust: <b>Ex</b> II 1 D Ex ia IIIC T125 °C Da	
Umgebungstemperatur und Mediumtemperatur [°C]	Gas: T6: -20 ≤ Ta ≤ +40 T5: -20 ≤ Ta ≤ +55 T4: -20 ≤ Ta ≤ +85 T3: -20 ≤ Ta ≤ +85 Dust: -20 ≤ Ta ≤ +85	
Maximum values	Ui = 13.65 V / li = 200 mA / Pi = 0.69 W / Ci = 0.27 nF / Li = 1.30 µH	
Start-up time typ. [s]	8 (2...18)	
Reaction time typ. [s]	2 (1...13)	
Cable gland [mm]	clamping range 5.5...8.5	
Housing material	AISI 316 Ti • different materials on request	
Protection [EN 60529]	IP 67	
Connection cable	2 m PVC 4x0.75 mm <sup>2</sup> (number 1-4)	

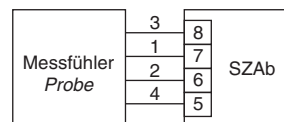
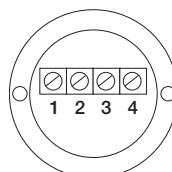

Observe specific conditions for use in section "Technique and application" on page 1.13

**Note:** for the connection to amplifier SZAb..., page 1.104-1.105



**Ex-Probe** | Device category 1G, 1G/2G and 1D

**Ex**-Device category 1G  
Installation in Zone 0 (gas)

**Ex**-Device category 1G/2G  
Installation in partition wall  
Zone 0 / Zone 1 (gas)

**Ex**-Device category 1D  
Installation in Zone 20 (dust)



Design		G1/2	
<b>Dimensions</b>			
Detection range	[m/s]	air 2...25	
Sensor length	[mm]	65	
Connection		fixed cable	plug
ID-No.		P11152	P11206
Type		STS 212 K	STS 212 S
Ex area of use		Gas: Zone 0, Partition wall Zone 0 / Zone 1 / Dust: Zone 20	
Certificate No.		TÜV 98 ATEX 1298 X	
Ex marking		Gas: <b>Ex</b> II 1 G Ex ia IIC T4...T3 Ga <b>Ex</b> II 1/2 G Ex ia IIC T4...T3 Ga/Gb Dust: <b>Ex</b> II 1 D Ex ia IIIC T145 °C Da	
Ambient temperature and medium temperature	[°C]	Gas: T4: -20 ≤ Ta ≤ +70 T3: -20 ≤ Ta ≤ +85 Dust: -20 ≤ Ta ≤ +85	
Maximum values		Ui = 13.65 V / li = 200 mA / Pi = 0.69 W / Ci = 0.27 nF / Li = 1.30 µH	
Start-up time typ.	[s]	10...40	
Reaction time typ.	[s]	5 (2...30)	
Compressive strength	[bar]	10	
Housing material		AISI 316 Ti • different materials on request	
Protection	[EN 60529]	IP 67	
Connection		2 m PUR-cable 4x0.25 mm <sup>2</sup>	M12 connector
		Observe specific conditions for use in section "Technique and application" on page 1.13	
Note:		for the connection to amplifier SZAb..., page 1.104-1.105	



**Ex-Probe** | Device category 1G, 1G/2G and 1D

**Ex**-Device category 1G  
Installation in Zone 0 (gas)

**Ex**-Device category 1G/2G  
Installation in partition wall  
Zone 0 / Zone 1 (gas)

**Ex**-Device category 1D  
Installation in Zone 20 (dust)



Design	G1/2	
<b>Dimensions</b>		
<b>Detection range</b> [m/s]	air 2...25	
<b>Sensor length</b> [mm]	48	
<b>Connection</b>	fixed cable / plug	
<b>ID-No.</b>	P11153 / P11207	
<b>Type</b>	STS 215 K / STS 215 S	
<b>Ex area of use</b>	Gas: Zone 0, Partition wall Zone 0 / Zone 1 / Dust: Zone 20	
<b>Certificate No.</b>	TÜV 98 ATEX 1298 X	
<b>Ex marking</b>	Gas: $\text{Ex}$ II 1 G Ex ia IIC T6...T3 Ga $\text{Ex}$ II 1/2 G Ex ia IIC T6...T3 Ga/Gb Dust: $\text{Ex}$ II 1 D Ex ia IIIC T130 °C Da	
<b>Ambient temperature and medium temperature</b> [°C]	Gas: T6: $-20 \leq T_a \leq +35$ T5: $-20 \leq T_a \leq +50$ T4: $-20 \leq T_a \leq +85$ T3: $-20 \leq T_a \leq +85$ Dust: $-20 \leq T_a \leq +85$	
<b>Maximum values</b>	$U_i = 13.65 \text{ V}$ / $I_i = 200 \text{ mA}$ / $P_i = 0.69 \text{ W}$ / $C_i = 0.27 \text{ nF}$ / $L_i = 1.30 \text{ }\mu\text{H}$	
<b>Start-up time typ.</b> [s]	5...20	
<b>Reaction time typ.</b> [s]	3 (2...30)	
<b>Compressive strength</b> [bar]	10	
<b>Housing material</b>	AISI 316 Ti • different materials on request	
<b>Protection</b> [EN 60529]	IP 67	
<b>Connection</b>	2 m PUR-cable 4x0.25 mm <sup>2</sup>	M12 connector
<b>Note:</b>	Observe specific conditions for use in section "Technique and application" on page 1.13 for the connection to amplifier SZAb..., page 1.104-1.105	



**Ex-Probe** | Device category 1G, 1G/2G and 1D

**Ex**-Device category 1G  
Installation in Zone 0 (gas)

**Ex**-Device category 1G/2G  
Installation in partition wall  
Zone 0 / Zone 1 (gas)

**Ex**-Device category 1D  
Installation in Zone 20 (dust)



Extended temperature range up to 120 °C

Design	G1/2	
<b>Dimensions</b>		
Detection range [m/s]	air 2...25	
Sensor length [mm]	48	
Connection	fixed cable	
ID-No.	P11212	
Type	STS 215 KH	
Ex area of use	Gas: Zone 0, Partition wall Zone 0 / Zone 1 / Dust: Zone 20	
Certificate No.	TÜV 98 ATEX 1298 X	
Ex marking	Gas: <b>Ex</b> II 1 G Ex ia IIC T6...T3 Ga <b>Ex</b> II 1/2 G Ex ia IIC T6...T3 Ga/Gb Dust: <b>Ex</b> II 1 D Ex ia IIIC T130 °C Da	
Ambient temperature and medium temperature [°C]	Gas: T6: - 20 ≤ Ta ≤ +35 T5: - 20 ≤ Ta ≤ +50 T4: - 20 ≤ Ta ≤ +85 T3: - 20 ≤ Ta ≤ +120 Dust: - 20 ≤ Ta ≤ +85	
Maximum values	U <sub>i</sub> = 13.65 V / I <sub>i</sub> = 200 mA / P <sub>i</sub> = 0.69 W / C <sub>i</sub> = 0.27 nF / L <sub>i</sub> = 1.30 μH	
Start-up time typ. [s]	5...20	
Reaction time typ. [s]	3 (2...30)	
Compressive strength [bar]	10	
Housing material	AISI 316 Ti • different materials on request	
Protection [EN 60529]	IP 67	
Connection	2 m FEP-cable 4x0.25 mm <sup>2</sup>	
Note:	Observe specific conditions for use in section "Technique and application" on page 1.13 for the connection to amplifier SZAb..., page 1.104-1.105	



**Ex**-Amplifiers AC/DC | Relay

Ex II (1) G [Ex ia Ga] IIC  
 Ex II (1) D [Ex ia Da] IIIC

AC 230 V • AC 115 V • DC 24 V

Relay output

Cable break and short circuit monitoring

Turn off delay



**Design** **SZAb 400 EX...**

*Dimensions*

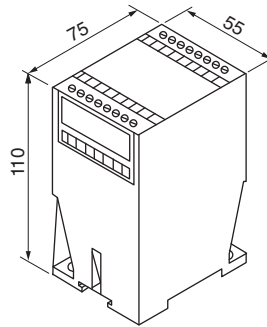

ID-No.	P11400	P11399	P11398
Type	SZAb 400 EX-WR230	SZAb 400 EX-WR115	SZAb 400 EX-GR
Output			
Supply voltage [V]	230 AC ±10%	115 AC ±10%	24 DC ±15%
Ex marking	Gas: Ex II (1) G [Ex ia Ga] IIC		Dust: Ex II (1) D [Ex ia Da] IIIC
Certificate No.	EPS 19 ATEX 1 009		IECEx EPS 19.0001
Maximum values	U <sub>o</sub> = 13.65 V I <sub>o</sub> = 200 mA P <sub>o</sub> = 683 mW IIC: C <sub>o</sub> = 0.35 µF; L <sub>o</sub> = 1.1 mH IIB: C <sub>o</sub> = 1.8 µF; L <sub>o</sub> = 6.2 mH IIA: C <sub>o</sub> = 5.7 µF; L <sub>o</sub> = 11.0 mH		
Turn off delay [s]	0...25		
Output	relay / change-over		
Switching voltage [V]	250 AC / 60 DC / 24 DC		
Switching current [A]	4 AC / 0.8 DC / 4 DC		
Switching power	cos φ >0,7 / L/R <200 ms		
Ambient temperature [°C]	-20 ≤ T <sub>a</sub> ≤ +60		
Protection [EN 60529]	IP 20		
Connection	terminal screws		

**Note:**

The Ex-amplifier must be mounted outside hazardous areas (gas or dust).

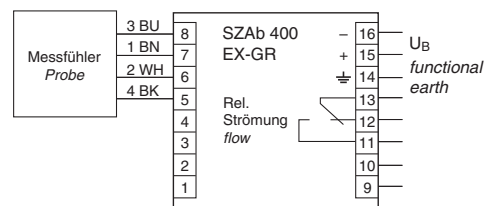
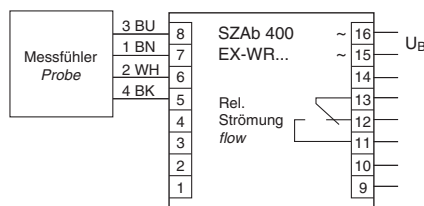





**Ex**-Amplifier DC | Analog

**Ex** II (1) G [Ex ia Ga] IIC  
**Ex** II (1) D [Ex ia Da] IIIC

DC 24 V

Analog output

Cable break and short circuit monitoring



**Design** **SZAb 400 EX-GA**

*Dimensions*

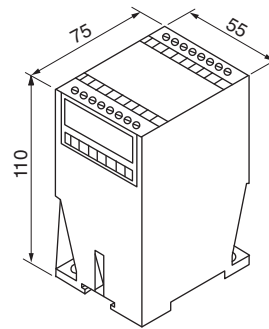

ID-No.	P11401	
Type	SZAb 400 EX-GA	
Output	 4...20 mA	
Supply voltage [V]	24 DC ±15%	
Ex marking	Gas: <b>Ex</b> II (1) G [Ex ia Ga] IIC	Staub: <b>Ex</b> II (1) D [Ex ia Da] IIIC
Certificate No.	EPS 19 ATEX 1 009	IECEx EPS 19.0001
Maximum values	U <sub>o</sub> = 13.65 V I <sub>o</sub> = 200 mA P <sub>o</sub> = 683 mW IIC: Co = 0.35 µF; Lo = 1.1 mH IIB: Co = 1.8 µF; Lo = 6.2 mH IIA: Co = 5.7 µF; Lo = 11.0 mH	
Output	analog, non linear	
Current output [mA]	4...20	
Load R <sub>L</sub> [Ω]	0...500	
Ambient temperature [°C]	-20 ≤ Ta ≤ +60	
Protection [EN 60529]	IP 20	
Connection	terminal screws	

Note:  
 The Ex-amplifier must be mounted outside hazardous areas (gas or dust).

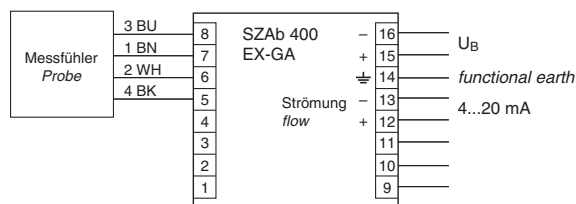



**Ex**-Compact model | Device category 3G and 3D

**Ex**-Device category 3G  
Installation in Zone 2 (gas)

**Ex**-Device category 3D  
Installation in Zone 22 (dust)

DC 24 V

PNP output



Design	M18x1	
<b>Dimensions</b>		
Detection range	[m/s]	gaseous media 0.5...20
Sensor length L	[mm]	80
Output		 PNP
ID-No.		<b>P11404</b>
Type		LC 518 GSP-Ex22
Ex area of use		Gas: Zone 2 / Dust: Zone 22
Certificate of conformity		EGE 20.0010 X
Ex marking	Gas:	<b>Ex</b> II 3 G Ex ic mc IIC T4...T3 Gc
	Dust:	<b>Ex</b> II 3 D Ex ic mc IIIC T135 °C Dc
Ambient temperature and medium temperature	Gas:	T3, T4: -10 ≤ Ta ≤ +60
	Dust:	-10 ≤ Ta ≤ +60
Supply voltage	[V]	24 DC ±10%
Current consumption	[mA]	≤ 35
Switching current	[mA]	≤ 200
Start-up time typ.	[s]	20
Reaction time typ.	[s]	< 5
Compressive strength	[bar]	1
Housing material		AISI 316 Ti, PBT-GF30, PUR, ceramic Al <sub>2</sub> O <sub>3</sub>
Display flow		three-colour-illuminated dot red/yellow/green
Protection	[EN 60529]	IP 67
Connection		2 m PUR-cable 3x0.5 mm <sup>2</sup>



**Ex**-Compact model | Device category 3G and 3D

**Ex**-Device category 3G  
Installation in Zone 2 (gas)

**Ex**-Device category 3D  
Installation in Zone 22 (dust)

DC 24 V

Analog output



Design	M18x1	
<b>Dimensions</b>		
Detection range [m/s]	gaseous media 0.5...20	
Sensor length L [mm]	80	
Output	 4...20 mA	
ID-No.	P11421	
Type	LC 518 GA-Ex22	
Ex area of use	Gas: Zone 2 / Dust: Zone 22	
Certificate of conformity	EGE 20.0010 X	
Ex marking	Gas:	<b>Ex</b> II 3 G Ex ic mc IIC T4...T3 Gc
	Dust:	<b>Ex</b> II 3 D Ex ic mc IIIC T135 °C Dc
Ambient temperature and medium temperature [°C]	Gas:	T3, T4: -10 ≤ Ta ≤ +60
	Dust:	-10 ≤ Ta ≤ +60
Supply voltage [V]	24 DC ±10%	
Current consumption [mA]	≤ 35	
Current output [mA]	4...20	
Start-up time typ. [s]	20	
Reaction time typ. [s]	< 5	
Compressive strength [bar]	1	
Housing material	AISI 316 Ti, PBT-GF30, PUR, ceramic Al <sub>2</sub> O <sub>3</sub>	
Display flow	two-colour-illuminated dot red/green	
Protection [EN 60529]	IP 67	
Connection	2 m PUR-cable 3x0.5 mm <sup>2</sup>	



**Ex**-Compact model | Device category 3G and 3D

**Ex**-Device category 3G  
Installation in Zone 2 (gas)

**Ex**-Device category 3D  
Installation in Zone 22 (dust)

DC 24 V

PNP output



**Design** **G1/2**

*Dimensions*

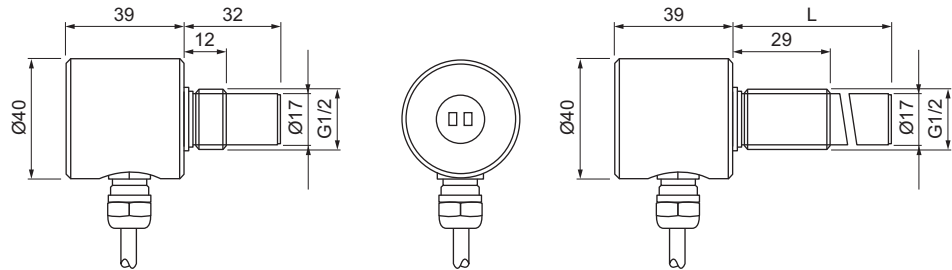

Detection range	[m/s]	gaseous media 0.5...20			
Sensor length L	[mm]	32	49	101	151
Output		 PNP			
ID-No.		<b>P11405</b>	<b>P11406</b>	<b>P11407</b>	<b>P11408</b>
Type		LC 521 GSP-Ex22	LC 521/1 GSP-Ex22	LC 521/2 GSP-Ex22	LC 521/3 GSP-Ex22
Ex area of use		Gas: Zone 2 / Dust: Zone 22			
Certificate of conformity		EGE 20.0010 X			
Ex marking		Gas:	II 3 G Ex ic mc IIC T4...T3 Gc		
		Dust:	II 3 D Ex ic mc IIIC T135 °C Dc		
Ambient temperature and medium temperature	[°C]	Gas:	T3, T4: -10 ≤ Ta ≤ +60		
		Dust:	-10 ≤ Ta ≤ +60		
Supply voltage	[V]	24 DC ±10%			
Current consumption	[mA]	≤ 35			
Switching current	[mA]	≤ 200			
Start-up time typ.	[s]	20			
Reaction time typ.	[s]	< 5			
Compressive strength	[bar]	1			
Housing material		AISI 316 Ti, PBT-GF30, PUR, ceramic AL <sub>2</sub> O <sub>3</sub>			
Display flow		three-colour-illuminated dot red/yellow/green			
Protection	[EN 60529]	IP 67			
Connection		2 m PUR-cable 3x0.5 mm <sup>2</sup>			

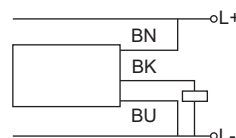



**Ex**-Compact model | Device category 3G and 3D

**Ex**-Device category 3G  
Installation in Zone 2 (gas)

**Ex**-Device category 3D  
Installation in Zone 22 (dust)

DC 24 V

Analog output

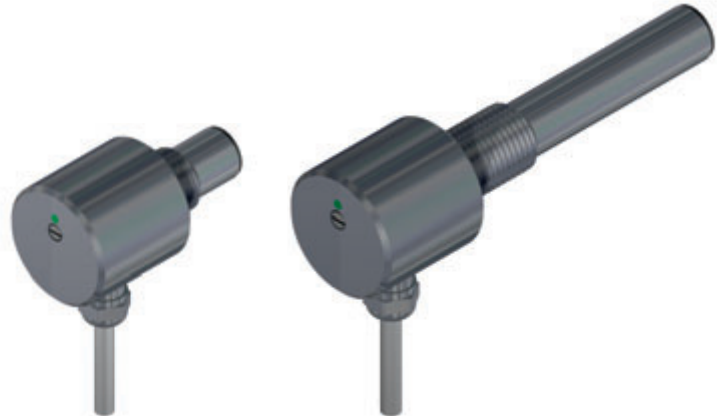

Design	G1/2			
<b>Dimensions</b>				
Detection range [m/s]	gaseous media 0.5...20			
Sensor length L [mm]	32	49	101	151
Output	 4...20 mA			
ID-No.	P11422	P11423	P11424	P11425
Type	LC 521 GA-Ex22	LC 521/1 GA-Ex22	LC 521/2 GA-Ex22	LC 521/3 GA-Ex22
Ex area of use	Gas: Zone 2 / Dust: Zone 22			
Certificate of conformity	EGE 20.0010 X			
Ex marking	Gas:	Ex II 3 G Ex ic mc IIC T4...T3 Gc		
	Dust:	Ex II 3 D Ex ic mc IIIC T135 °C Dc		
Ambient temperature and medium temperature [°C]	Gas:	T3, T4: -10 ≤ Ta ≤ +60		
	Dust:	-10 ≤ Ta ≤ +60		
Supply voltage [V]	24 DC ±10%			
Current consumption [mA]	≤ 35			
Current output [mA]	4...20			
Start-up time typ. [s]	20			
Reaction time typ. [s]	< 5			
Compressive strength [bar]	1			
Housing material	AISI 316 Ti, PBT-GF30, PUR, ceramic Al <sub>2</sub> O <sub>3</sub>			
Display flow	two-colour-illuminated dot red/green			
Protection [EN 60529]	IP 67			
Connection	2 m PUR-cable 3x0.5 mm <sup>2</sup>			



**Ex**-Junction box | Device category 2G and 2D

For the connection of supply and signal lines in explosion hazardous areas of zone 1 and zone 21

Clamp fastening



Design	GK E...		
Dimensions			
ID-No.	Z01222	Z01232	Z01246
Type	GK E 060 K M	GK E 080 K M	GK E 100 K M
Number of clamps	4	2 x 4	3 x 4
Dimensions (BxTxH) [mm]	58x64x36	98x64x36	150x64x36
Ignition protection type	Gas: increased safety		
Ex marking	Dust: protection through enclosure		
	Gas: $\text{Ex II 2G Ex eb IIC T6 Gb}$		
Certificate No.	Dust: $\text{Ex II 2D Ex tb IIIC T 80 °C Db}$		
	TÜV 16 ATEX 152979 X		
Ambient temperature [°C]	Gas: T3, T4, T5, T6: $-20 \leq T_a \leq +75$		
Voltage [V]	Dust: $-20 \leq T_a \leq +75$		
	Um $\leq 275$		
Current [A]	Im $\leq 2$		
Type of terminal	terminal with no screws		
Rated cross-section	„e+t“ single wire: 0.20...2.5 mm <sup>2</sup> / flexible: 0.20...2.5 mm <sup>2</sup>		
Clamping range of cable gland [mm]	flexible: 0.20...2.5 mm <sup>2</sup> (with wire end ferrule)		
	5.0...10.0		
Material	2.0...6.0 (with reduction insert RDE 16)		
	housing: aluminium powder coated / cable gland: Br-Ni / PA / EPDM		
Protection [EN 60529]	IP 65		
Connection	terminal compartment		

Note:

The Ex-junction box type GK E... is designed for the connection of non-intrinsically safe circuits in explosion-hazardous areas of zone 1 and zone 21. Outside of the housing, the lines must be installed permanently; further provisions must be observed if required.

Additional housings, additional terminals and plastic cable glands are available on request.

Accessories	reduction insert RDE 16 (part of delivery)
-------------	--





**Ex-Junction box** | Device category 2G and 2D

For the connection of supply and signal lines in explosion hazardous areas of zone 1 and zone 21

Clamp fastening



Design	GK I...		
<b>Dimensions</b>			
<b>ID-No.</b>	Z01224	Z01234	Z01248
<b>Type</b>	GK I 060 K M	GK I 080 K M	GK I 100 K M
<b>Number of clamps</b>	4	2 x 4	3 x 4
<b>Dimensions (BxTxH) [mm]</b>	58x64x36	98x64x36	150x64x36
<b>Ignition protection type</b>	Gas: intrinsic safety		
<b>Ex marking</b>	Dust: intrinsic safety Gas: Ex II 2G Ex ib/ia IIC T6 Gb Dust: Ex II 2D Ex ib/ia IIIC T 80 °C Db		
<b>Certificate No.</b>	TÜV 16 ATEX 152979 X		
<b>Ambient temperature [°C]</b>	Gas: T3, T4, T5, T6: -20 ≤ Ta ≤ +75 Dust: -20 ≤ Ta ≤ +75		
<b>Voltage [V]</b>	Ui = 90		
<b>Current [A]</b>	Ii = 2.0		
<b>Type of terminal</b>	terminal with no screws		
<b>Rated cross-section</b>	„I“ single wire: 0.08...2.5 mm <sup>2</sup> / flexible: 0.08...2.5 mm <sup>2</sup> flexible: 0.08...2.5 mm <sup>2</sup> (with wire end ferrule)		
<b>Clamping range of cable gland [mm]</b>	5.0...10.0 2.0...6.0 (with reduction insert RDE 16)		
<b>Material</b>	housing: aluminium powder coated / cable gland: Br-Ni / PA / EPDM		
<b>Protection [EN 60529]</b>	IP 65		
<b>Connection</b>	terminal compartment		

Note:

The Ex-junction box type GK I... is designed for the connection of intrinsically safe circuits in explosion-hazardous areas of zone 1 and zone 21. Outside of the housing, the lines must be installed permanently; further provisions must be observed if required.

Additional housings, additional terminals and plastic cable glands are available on request.

Accessories	reduction insert RDE 16 (part of delivery)
-------------	--



**Ex**-Junction box | Device category 2G and 2D

For the connection of supply and signal lines in explosion hazardous areas of zone 1 and zone 21

Clamp fastening



Design	GK EI...	GK EEI...	GK EII...
Dimensions			
ID-No.	Z01236	Z01250	Z01252
Type	GK EI 080 K M	GK EEI 100 K M	GK EII 100 K M
Number of clamps	4 / 4	4 + 4 / 4	4 / 4 + 4
Dimensions (BxTxH) [mm]	98x64x36	150x64x36	150x64x36
Ignition protection type	Gas: increased safety / intrinsic safety		
Ex marking	Dust: protection through enclosure / intrinsic safety		
	Gas: $\text{Ex}$ II 2G Ex eb ib/ia IIC T6 Gb		
Certificate No.	Dust: $\text{Ex}$ II 2D Ex tb ib/ia IIIC T 80 °C Db		
	TÜV 16 ATEX 152979 X		
Ambient temperature [°C]	Gas: T3, T4, T5, T6: $-20 \leq T_a \leq +75$		
	Dust: $-20 \leq T_a \leq +75$		
Voltage [V]	$U_m \leq 275 / U_i = 90$		
Current [A]	$I_m \leq 2 / I_i = 2.0$		
Type of terminal	terminal with no screws		
Rated cross-section	„i“ single wire: 0.08...2.5 mm <sup>2</sup> / flexible: 0.08...2.5 mm <sup>2</sup>		
	flexible: 0.08...2.5 mm <sup>2</sup> (with wire end ferrule)		
Clamping range of cable gland [mm]	„e+t“ single wire: 0.20...2.5 mm <sup>2</sup> / flexible: 0.20...2.5 mm <sup>2</sup>		
	flexible: 0.20...2.5 mm <sup>2</sup> (with wire end ferrule)		
Material	housing: aluminium powder coated / cable gland: Br-Ni / PA / EPDM		
Protection [EN 60529]	IP 65		
Connection	terminal compartment		

Note:

The Ex-junction box type GK... is designed for the connection of intrinsically safe and / or non-intrinsically safe circuits in explosion-hazardous areas of zone 1 and zone 21. Outside of the housing, the lines must be installed permanently; further provisions must be observed if required.

Additional housings, additional terminals and plastic cable glands are available on request.

Zubehör	Reduziereinsatz RDE 16 (im Lieferumfang enthalten)
---------	--



# Accessories | IO-Link-Master

Parametrization of IO-Link-devices

Version 1.1 - Universally usable

Easy configurable software



Design	USB
<b>Dimensions</b>	<p>1: mini USB 2: LED operating state / fault display 3: 24 V DC Ø 5.5/2.1 mm 4: M12 type A connector</p>
Application area	parametrization of devices with IO-Link-functions and monitoring of process data
Communications protocol	COM 1 (4.8 kBit/s), COM 2 (38.4 kBit/s), COM 3 (230 kBit/s)
Related software	Port and Device Configuration Tool 1
Output	
ID-No.	<b>Z01216</b>
Type	IO-Link-USB-Master-Set v1.1
Input voltage [V]	USB: 5 DC / external power supply: 24 DC (EN 60950)
Input current [mA]	USB: < 500 / external power supply: < 600
Output voltage [V]	USB: 24 DC / external power supply: see input voltage
Output current [mA]	USB: < 65 / external power supply: < 500
LED displays	
Green	continuous: Master ready for operation, flashes: IO-Link-communication active
Red	continuous and green LED off: fault
Material	aluminium, eloxed
Protection [EN 60529]	IP 20
Connection	M12 connector / type A / socket
1Download of iqPDCT-software from <a href="http://www.iq2-development.de/downloads">www.iq2-development.de/downloads</a> .	<p>1: +24 V 2: not used 3: GND 4: IO-Link: CH1 (C/Q) 5: not used</p> <p>1: +5 V 2: D- 3: D+ 4: not used 5: GND</p>
Accessories (incl. at delivery)	USB-connecting cable, M12-sensor-connecting cable 2 m, power supply 230 V AC / 24 V DC



# Accessories | M12 connector

Finished cable plug housing  
Self locking screw plug  
Protection IP 67

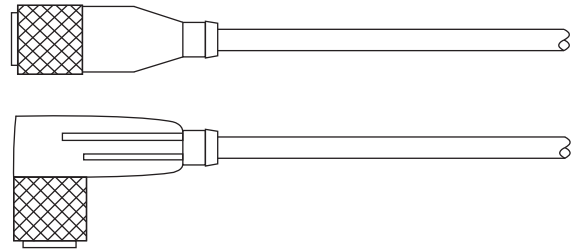

## Cable plug housing

## Pin-assignment

straight

angular

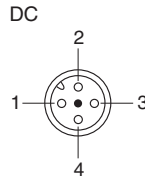
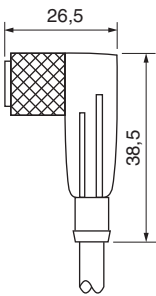
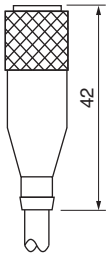

- 3-wire**
- 1: BN
  - 2: -
  - 3: BU
  - 4: BK
- 4-wire**
- 1: BN
  - 2: WH
  - 3: BU
  - 4: BK

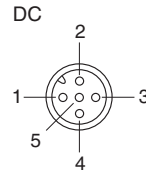

- 5-wire**
- 1: BN
  - 2: WH
  - 3: BU
  - 4: BK
  - 5: GY

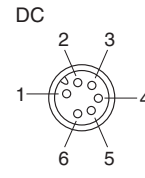

- 6-wire**
- 1: BN
  - 2: WH
  - 3: BU
  - 4: BK
  - 5: GY
  - 6: PK

SLG...

SLW...

DC

TYPE	ID-NO.	DESIGN
SLG 3-2	Z01076	Cable plug housing straight, 2 m cable 3x0.34 mm <sup>2</sup> max. 250 V / 4 A
SLG 3-5	Z01077	Cable plug housing straight, 5 m cable 3x0.34 mm <sup>2</sup> max. 250 V / 4 A
SLW 3-2	Z01078	Cable plug housing angular, 2 m cable 3x0.34 mm <sup>2</sup> max. 250 V / 4 A
SLW 3-5	Z01079	Cable plug housing angular, 5 m cable 3x0.34 mm <sup>2</sup> max. 250 V / 4 A
SLW 3-2-LED	Z00052	Cable plug housing angular, 2 m cable 3x0.34 mm <sup>2</sup> max. 250 V / 4 A PNP with LED
SLG 4-2	Z00445	Cable plug housing straight, 2 m cable 4x0.25 mm <sup>2</sup> max. 250 V / 4 A
SLG 4-5	Z00449	Cable plug housing straight, 5 m cable 4x0.25 mm <sup>2</sup> max. 250 V / 4 A
SLW 4-2	Z00446	Cable plug housing angular, 2 m cable 4x0.25 mm <sup>2</sup> max. 250 V / 4 A
SLW 4-5	Z00450	Cable plug housing angular, 5 m cable 4x0.25 mm <sup>2</sup> max. 250 V / 4 A
SLW 4-2-LED	Z01157	Cable plug housing angular, 2 m cable 4x0.25 mm <sup>2</sup> max. 250 V / 4 A PNP with LED
SLG 5-2	Z01150	Cable plug housing straight, 2 m cable 5x0.34 mm <sup>2</sup> max. 60 V / 2 A
SLW 5-2	Z01151	Cable plug housing angular, 2 m cable 5x0.34 mm <sup>2</sup> max. 60 V / 2 A
SLG 6-2	Z01197	Cable plug housing straight, 2 m cable 6x0.25 mm <sup>2</sup> max. 36 V / 2 A
SLW 6-2	Z01198	Cable plug housing angular, 2 m cable 6x0.25 mm <sup>2</sup> max. 36 V / 2 A

### DATA

Thread	M12x1	Contact resistance	≤ 5 mΩ
Material	PVC	Insulation resistance	>10 <sup>9</sup>
Protection	IP 67	Testing voltage	2.0 KV eff. / 5 and 6 pol. 1.5 KV eff.
Temperature range	-25...+80 °C		

### Note:

Sensors with NC output are connected to 4 pole cable plug housings. In this case, the break output is connected to the white lead (connection 2).



## Accessories | M12 connector

Cable plug user-assembled  
Great variety of cables  
Protection IP 67



**Cable plug housing straight**

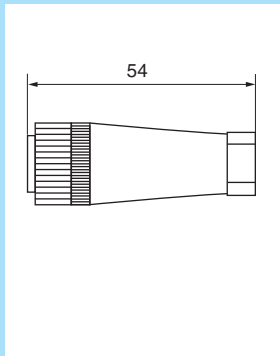

**SBG...**

**Cable plug housing angular**

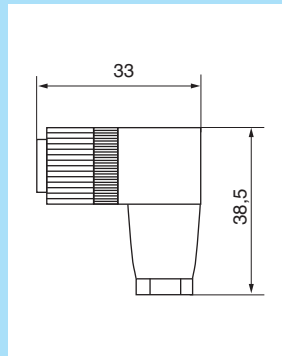

**SBW...**

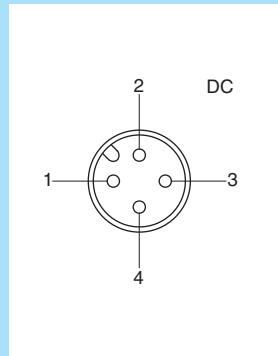

**SBG.../SBW...**

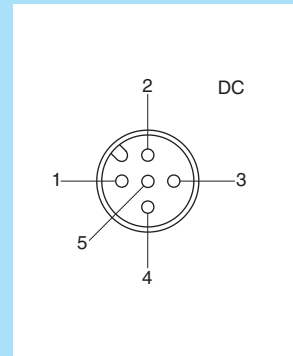

**SBG 5.../SBW 5...**

TYPE	ID-NO.	DESIGN
SBG-DC	Z01060	DC-Cable plug housing M12x1, straight 4-pol user assembled 30 VDC, 3 A
SBW-DC	Z00038	DC-Cable plug housing M12x1, angular 4-pol user assembled 30 VDC, 3 A
SBG 5-DC	Z01146	DC-Cable plug housing M12x1, straight 5-pol user assembled 30 VDC, 1 A
SBW 5-DC	Z01147	DC-Cable plug housing M12x1, angular 5-pol user assembled 30 VDC, 1 A

**PREFERRED CABLE**

PVC 205	Z01061	PVC-cable 2x0.5 mm <sup>2</sup>	Lead colour coding: BN/BU
PVC 205B	Z01062	PVC-cable 2x0.5 mm <sup>2</sup> , blue cable covering	Lead colour coding: BN/BU
PVC 305	Z01063	PVC-cable 3x0.5 mm <sup>2</sup>	Lead colour coding: BN/BU/BK
PVC 434	Z01066	PVC-cable 4x0.34 mm <sup>2</sup>	Lead colour coding: BN/BU/BK/WH
PVC 405	Z01067	PVC-cable 4x0.5 mm <sup>2</sup>	Lead colour coding: BN/BU/BK/WH
PVC 505	Z01116	PVC-cable 5x0.5 mm <sup>2</sup>	Lead colour coding: BN/BU/BK/WH/GY
PUR 425S	Z01069	PUR-cable 4x0.25 mm <sup>2</sup> , shielded	Lead colour coding: BN/BU/BK/WH
PUR 425BS	Z01070	PUR-cable 4x0.25 mm <sup>2</sup> , shielded, blue cable covering	Lead colour coding: BN/BU/BK/WH
	Z01074	Finishing of cable plug housing	
	Z01075	Finishing of cable plug housing and cable extremity	

**Note**

Different cables on request.

Code: BK = black BN = brown BU = blue GN = green YE = yellow GY = grey PK = pink WH = white



## Accessories | Cable

TYPE	ID-NO.	MATERIAL/SHEAT	Ø <sub>A</sub> [mm]*	WIRE SPECIFICATION	COLOUR
PVC205	Z01061	PVC, grey	5.2	2x0.5 mm <sup>2</sup>	BU, BN
PVC205B	Z01062	PVC, blue	5.1	2x0.5 mm <sup>2</sup>	BU, BN
PVC275	Z01086	PVC, grey	6.0	2x0.75 mm <sup>2</sup>	BU, BN
PVC275BS	Z01108	PVC, blue	6.3	2x0.75 mm <sup>2</sup> shielded	numbered cable
PVC334	Z01109	PVC, grey	4.5	3x0.34 mm <sup>2</sup>	BU, BN, BK
PVC305E	Z01064	PVC, grey	5.2	3x0.5 mm <sup>2</sup>	BU, BN, GN/YE
PVC305	Z01063	PVC, grey	5.2	3x0.5 mm <sup>2</sup>	BU, BN, BK
PVC305B	Z01167	PVC, blue	5.2	3x0.5 mm <sup>2</sup>	BU, BN, BK
PVC375	Z01065	PVC, grey	6.0	3x0.75 mm <sup>2</sup>	numbered cable
PVC375E	Z01111	PVC, grey	6.0	3x0.75 mm <sup>2</sup>	BU, BN,GN/YE
PVC425	Z01110	PVC, grey	4.3	4x0.25 mm <sup>2</sup>	BU, BN, BK, WH
PVC434	Z01066	PVC, grey	4.5	4x0.34 mm <sup>2</sup>	BU, BN, BK, WH
PVC405	Z01067	PVC, grey	5.5	4x0.5 mm <sup>2</sup>	BU, BN, BK, WH
PVC475E	Z01113	PVC, grey	6.5	4x0.75 mm <sup>2</sup>	BU, BN, BK, GN/YE
PVC475BS	Z01114	PVC, blue	7.3	4x0.75 mm <sup>2</sup> shielded	numbered cable
PVC505	Z01116	PVC, grey	5.8	5x0.5 mm <sup>2</sup>	BU, BN, WH, BK, GY
PVC705	Z01117	PVC, grey	6.6	7x0.5 mm <sup>2</sup>	BU, BN, WH, GN/YE, GY, PK
PUR334	Z01156	PUR, grey	5.0	3x0.34 mm <sup>2</sup>	BU, BN, BK
PUR375	Z01068	PUR, black	6.0	3x0.75 mm <sup>2</sup> -40°C	BU, BN, BK
PUR425S	Z01069	PUR, grey	5.0	4x0.25 mm <sup>2</sup> shielded	BU, BN, WH, BK
PUR425BS	Z01070	PUR, blue	5.0	4x0.25 mm <sup>2</sup> shielded	BU, BN, WH, BK
PUR405	Z01112	PUR, black	5.0	4x0.5 mm <sup>2</sup>	BU, BN, WH, BK
PUR405BS	Z01173	PUR, blue	6.2	4x0.5 mm <sup>2</sup> shielded	BU, BN, WH, BK
PUR475SE	Z01118	PUR, grey	9.0	4x0.75 mm <sup>2</sup> shielded	numbered cable
PUR410E	Z01119	PUR, orange	8.0	4x1.0 mm <sup>2</sup>	BU, BN, BK, GN/YE
FEP375S	Z01126	FEP, red	5.0	3x0.75 mm <sup>2</sup> shielded	BU, BN, BK
FEP334	Z01071	FEP, red	3.8	3x0.34 mm <sup>2</sup>	BU, BN, BK
FEP425S	Z01073	FEP, red	4.1	4x0.25 mm <sup>2</sup> shielded	BU, BN, BK, WH
FEP425	Z01072	FEP, red	3.7	4x0.25 mm <sup>2</sup>	BU, BN, BK, WH
FEP425BS	Z01125	FEP, blue	4.1	4x0.25 mm <sup>2</sup> shielded	BU, BN, BK, WH
FEP375	Z01165	FEP, red	4.2	3x0.75 mm <sup>2</sup>	BU, BN, GN/YE
Silikon375E	Z01121	Silicone, red	6.0	3x0.75 mm <sup>2</sup>	BU, BN, GN/YE
Silikon475E	Z01122	Silicone, red	6.3	4x0.75 mm <sup>2</sup>	BU, BN, BK, GN/YE
Silikon475SE	Z01115	Silicone, red	8.8	4x0.75 mm <sup>2</sup> shielded	BU, BN, BK, GN/YE
Silikon305	Z01143	Silicone, red	5.5	3x0.5 mm <sup>2</sup>	BU, BN, BK
PVC705SE	Z01123	PVC-transparent	9.2	7x0.5 mm <sup>2</sup> shielded	numbered cable, GN/YE

\*Tolerance of diameter ±0,4 mm

Code: BK = black BN = brown BU = blue GN = green YE = yellow GY = grey PK = pink WH = white



Accessories | Product section 1

TYPE	ID-NO.	DIMENSIONS	DESIGN
Flange - Ø 20	Z01106		Plastic - flange with drilled hole Ø 20 mm  for sensors type LN 520
Flange DN25/PN40	Z01001		Flange AISI 316 Ti (1.4571) EN 1092-1/05 A (DIN 2527) with central thread G1/2  for sensors type ST... with G1/2
A501	Z01033		Thread sleeve of brass, nickel-plated L=50 mm, G1  for sensors type LN...
A502	Z01034		Thread sleeve of brass, nickel-plated L=50 mm, G1  for sensors type LN...
A503	Z01035		Welding sleeve of FE 360 B (1.0037), L=50 mm, G1  for sensors type LN...



# Accessories | Product section 1

TYPE	ID-NO.	DIMENSIONS	DESIGN
SIA G1/4 - 1/4 - 1/4	Z01018		<p>Adapter for G1/4-sensors with G1/4-pipe connections</p> <p>Material: AISI 316 Ti Sensors: STK 412...</p> <p>Massflow down to 10 ml/min</p> <p>(additional models on request)</p>
SDA-SCS-G1/4	Z01200 L = 39 mm		<p>Screw-in adapter G1/4 for flow sensors SCS, SNS, SNTS and ST418</p> <p>Material: AISI 316 Ti</p>
SDA-SCS-G1/2	Z01201 L = 30 mm		<p>Screw-in adapter G1/2 for flow sensors SCS, SNS, SNTS and ST418</p> <p>Material: AISI 316 Ti</p>
SDA-SCS-G1/2-L37	Z01208 L = 37 mm		<p>Material: AISI 316 Ti</p>
SDA G1/4-Ø10-L050	Z01175		<p>Adapter G1/4 for flow sensors inline-digital display SDN 5.../1..., SDV 652..., SDI 852/1...</p>
SDA G1/2-Ø18-L068	Z01176		<p>Adapter G1/2 for flow sensors inline-digital display SDN 552/3...</p>



# Process Sensors

## Level sensors

- For level monitoring  $-230...+230\text{ }^{\circ}\text{C}$
- Steam proof at a pressure of up to 30 bar
- For hot motor oil
- For liquid nitrogen
- For chemically aggressive media

## Ultrasonic sensors

- Switching distance up to 6000 mm
- Level monitoring
- Watertight housing
- Teach-in functions

## Pressure sensors

- Monitoring in pipes and containers
- Pressure up to 16 bar
- Level up to 10 m ( $\pm 1\text{ cm}$ )
- Compact models
- Programmable

## Temperature sensors

- Monitoring in pipes and containers
- Temperature  $-40...+120\text{ }^{\circ}\text{C}$  ( $\pm 0,3\text{ }^{\circ}\text{C}$ )
- Pressure up to 100 bar
- Compact models
- Multi use output NO/NC + analog

## Infrared detectors

- Measurement of temperature
- Monitoring of hot media
- Position control

## Metal detectors

- Detection of metal parts
- For harsh environment
- Large sensing range up to 400 mm
- Monitoring of bulk materials
- Machine protection



# Sales partners, wholesalers and representatives



ARGENTINA, Lomas de Zamora  
AUSTRALIA, Warabrook NSW 2304  
AUSTRIA, Wien  
BELGIUM, Aalst  
BRAZIL, Sao Paulo  
CANADA, Oldcastle – Ontario  
CHINA, Shanghai  
COLOMBIA, Bogota D.C.  
CZECH REPUBLIC, Ostrava  
DENMARK, Aabenraa  
ESTONIA, Tallinn  
FINLAND, Jyväskylä  
FRANCE, Nanteuil les Meaux  
GREECE, Sindos - Thessaloniki

GREAT BRITAIN, Staffordshire  
HUNGARY, Budapest  
INDIA, Mumbai  
IRELAND, Clane, Co. Kildare  
ISRAEL, Tel-Aviv  
ITALY, Carate Brianza (MI)  
JAPAN, Tokyo  
NAMIBIA, Windhoek  
NETHERLANDS, LG Dordrecht  
NEW ZEALAND, Greenmount,  
Auckland  
NORWAY, Kolsås  
PHILIPPINES, Taguig City  
POLAND, Jezow Sudecki  
POLAND, Katowice

RUSSIAN FEDERATION, Moscow  
PORTUGAL, Porto  
ROMANIA, Bucharest  
SINGAPORE, Singapore  
SLOVAKIA, Banská Bystrica  
SLOVENIA, Ljubljana - Crnuce  
SOUTH AFRICA, Cleveland  
SOUTH KOREA, Gwangmyeongsi,  
Gyeonggi-do  
SPAIN, Nigran  
SWEDEN, Borås  
SWITZERLAND, Uster  
TAIWAN, New Taipeh City  
TURKEY, Kurtköy / Pendik / Istanbul  
USA, Gastonia  
VIETNAM, Ho Chi Minh City



<https://ege-elektronik.com/en/organisation/ege/>

We look forward to your enquiry.  
Please contact us!

EGE-Elektronik  
Spezial-Sensoren GmbH  
Ravensberg 34 • 24214 Gettorf • Germany  
T +49 (0) 4346-41580 F +49 (0) 4346-5658  
info@ege-elektronik.com  
**ege-elektronik.com**

E11120

