

Setting-Specific Representation of Tripping Characteristics and Competent Assessment of their Interaction

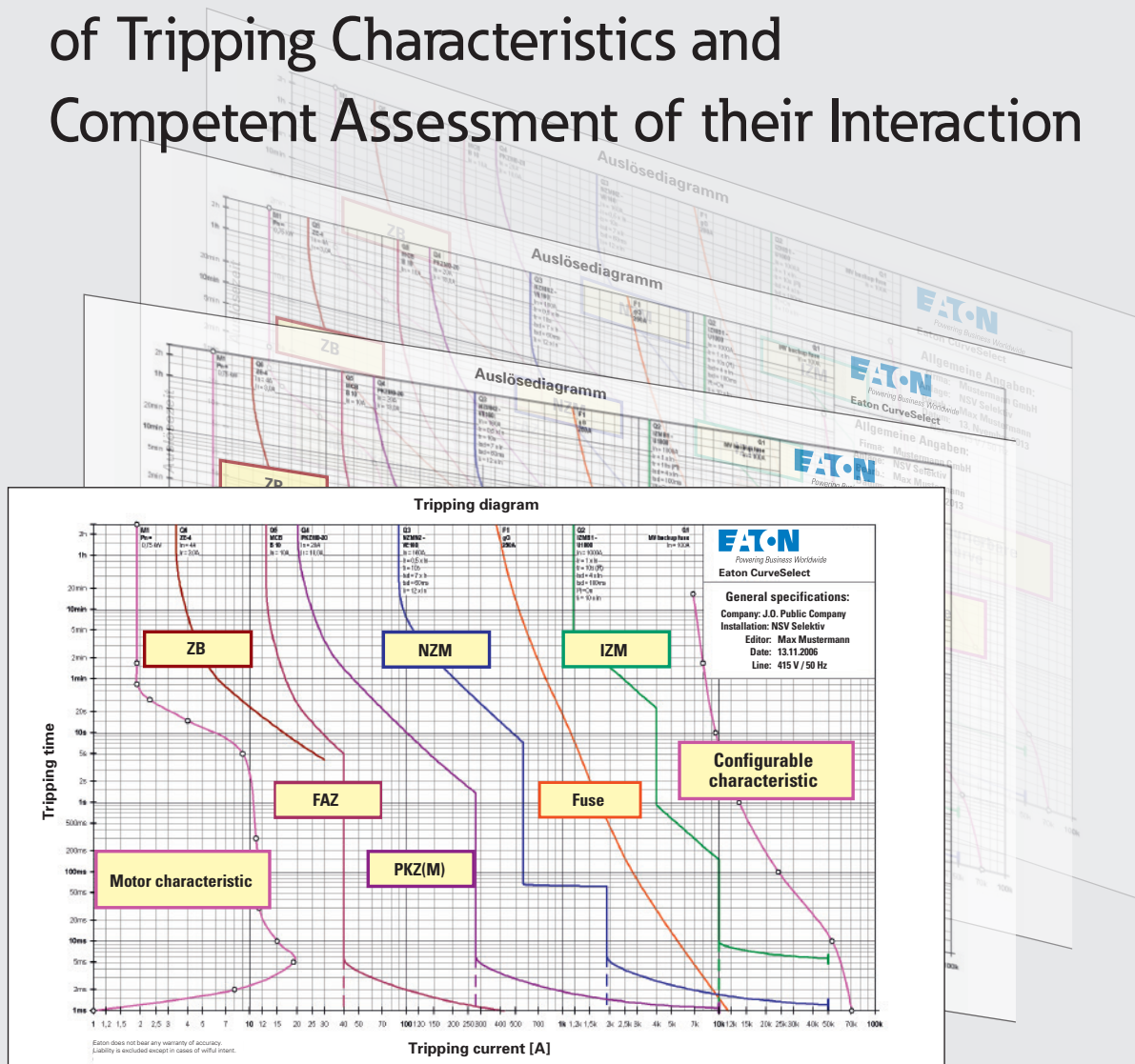

White Paper
Dipl.-Ing. Wolfgang Esser
Dipl.-Ing. Dirk Meyer
4th Revised Edition, 2014

Brief summary

Setting-specific representation of tripping characteristics and competent assessment of their interaction

– Explanations regarding the Eaton “CurveSelect” software tool –

If several protective devices are to interact effectively in a switchgear system, it is necessary to compare their tripping characteristics in order to evaluate their selectivity for the demands of enhanced system availability. It is important to use characteristic curves which take the actual individual settings on the protective devices into account for all tests. This is practically impossible with printed characteristic representations in catalogues. In this technical paper the device-specific setting features of different protective devices are presented and assigned to the various types of electrical equipment. The Eaton “CurveSelect” software tool enables a simple common representation of the curves on multiple protective devices on the same time and current scales for very little effort. This significantly simplifies the representation of the curves. The tool enables assessment of the Eaton circuit-breakers *NZM* and *IZM*, the motor-protective circuit-breaker *PKZM*, the miniature circuit-breaker *FAZ* (tripping characteristic B, C and D), the overload relay *ZB* and fuse types *gL* or *gG*. The characteristics of older switch generations are also shown with circuit-breakers to enable planning of possible expansions.

The additional features considerably add to the value software tool that can be used with 11 user languages. The handling of the 11 selectable languages can be found in the program *Read_Me* file that allows the entry mask and the representation of the results to be displayed in the chosen language. Eaton provides this helpful tool on the internet (**Figure 1**). The user is guided through the data entry phase by the provision of permissible parameters. The handling involved with the Excel file based tool is also briefly described in this technical paper. The result, which allows for common representation of the curves as protected engineering documentation with individual project designations, can be saved, printed or exported to other documents. But also those who are familiar with the physical fundamental principles and particularities of the equipment, should spare the time to read the section entitled “Handling of the Eaton *CurveSelect* program software tool” and consider the advantages of the improved tool.

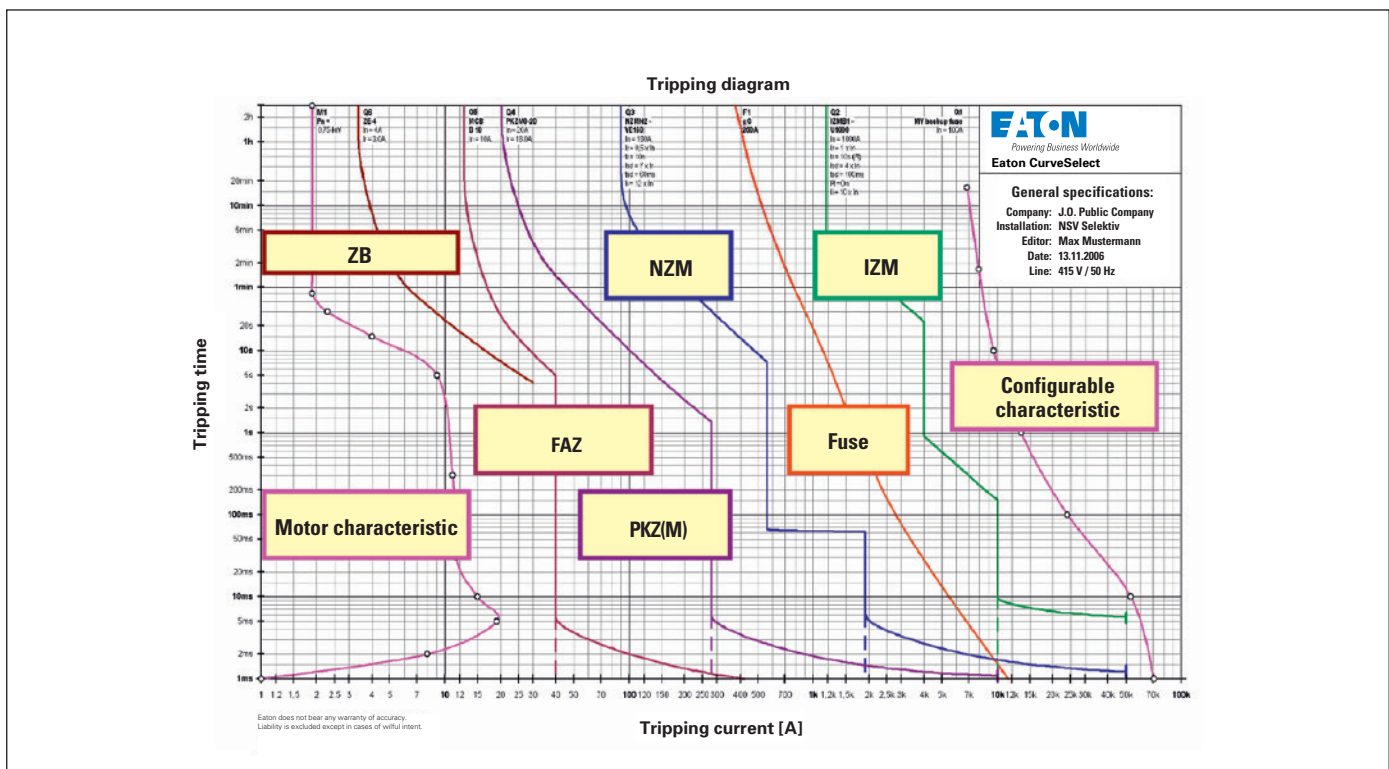

Figure 1: Representation of the tripping characteristic of different protective devices on the same time and current scale. The device data and settings are stated at the upper end of the curves.

Figure 2: The four frame sizes of the Eaton NZM compact circuit-breakers. Frame sizes NZM 1, NZM 2 and NZM 3 feature a thermo mechanical and electromechanical release. The frame sizes NZM 2, NZM 3 alternatively feature electronic releases as with the NZM 4 and the open circuit-breaker IZM as shown on the left.



Selection criteria for circuit-breakers – 4 main applications and personnel protection –

Circuit-breakers provide the highest level of complexity with the setting of their tripping characteristics among the protective devices in the low-voltage engineering field. The diverse setting possibilities are explained using the tried and tested *NZM* circuit-breaker as an example. The areas of application of the *NZM* circuit-breakers, with releases for overload and short-circuit currents and comprehensive system accessories, are also extremely diverse.

NZM compact circuit-breakers (MCCB¹) are offered by Eaton with electronic releases and with differing application-dependent variables for rated operational currents between 15 and 1600 A. The smallest switch frame size, the *NZM 1*, and a simple standard variant of the *NZM 2* and *NZM 3* frame size, do not feature an electronic release as they are exclusively equipped with electromechanical releases, intended as particularly attractively priced circuit-breakers and as the lowest non-delayed stage in a selectivity (discrimination) chain. Three switch frame sizes with the designations *NZM 2*, *NZM 3* and *NZM 4* contiguously cover the current range up to 1600 A and partly overlap in their ranges, with versatile electronic releases. The *IZM* open circuit-breakers (ICCB²) are additionally offered in three frame sizes for larger rated currents up to 6300 A (Figure 2). All switch frame sizes feature several variants with differing levels of short-circuit breaking capacity. The prices of the switches reflect the short-circuit breaking capacity performance as well as other features. As a result, the planning engineer can economically match the project-related switch rating to the required short-circuit rating of the system. The selected switching capacity defines – corresponding to Figure 7 – the lower end of the tripping characteristic which is presented later. Table 1 indicates the type variants available using a 3-pole switch in the IEC³ version. The range also includes switches

approved to the North American UL⁴ and CSA⁵ standards and the regional specific 4-pole circuit-breaker versions. The application-specific variants of the switch which are also indicated in Table 1 will also be described later.

The *NZM* circuit-breakers presented are used with differing protective tasks in practically every type of low-voltage power distribution system as outgoing circuit-breakers. In small to medium sized distribution systems, they also serve as incoming circuit-breakers up to 1600 A. In addition to pure power distribution tasks, the switches are used for the protection of various types of equipment against overload and short-circuit as well as for protection of the switchgear and the connecting cables and conductors and also in machines and system controls. They comprehensively master the four most important main application areas:

- protection of systems
- motor protection
- transformer protection and
- generator protection (Figure 3).

Protection of systems is understood as the protection of cables and conductors as well as the protection of busbar systems. It is highly significant in switchgear systems for power distribution (distribution board) – and not to be neglected – for busbar trunking systems, the attractive alternative to cables. Protection of systems also includes the protection of the switchgear, protective devices and control circuit devices as well as the automation control systems installed in the switchgear systems. The motor protection, generator protection and transformer protection fields of application serve the specific protection of stated equipment types [1]. For optimum protection and economic use of this equipment, the tripping characteristics of the protective devices must be matched as precisely as possible, by the settings described later, to the individual performance of the equipment to be protected. Economically viable operation also means that the protective devices do not trip when not intended.

1 MCCB = Molded Case Circuit Breaker
 2 ICCB = Insulated Case Circuit Breaker
 3 IEC = International Electrical Commission

4 UL = Underwriter's Laboratories (<http://www.ul.com>)
 5 CSA = Canadian Standards Association (<http://www.csa.ca>)



← c)

b) →

↓ d)



a) →

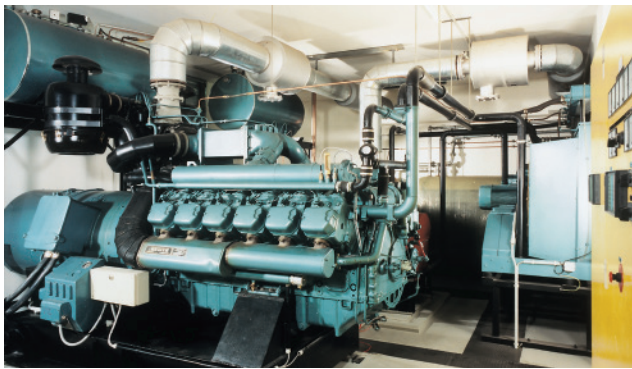

Figure 3: The four main applications of the NZM compact circuit-breakers, for which IZM circuit-breakers are partly used with higher currents:
a) protection of systems / line protection b) transformer protection c) motor protection d) generator protection

In addition to these functions which are primarily intended to protect the equipment, the additional personnel protection demands should not be neglected. Personnel protection is implemented with all switch types as protection against electrical shock, by fast automatic shutdown of dangerous touch voltages. Sufficiently short tripping times must be ensured by the engineering and dimensioning of the switch, e.g. by the observance of the "protective multiple earthing conditions" (IEC / EN 60 364-4-41, VDE 0100 Part 410) [2]. The following additional protective functions do not influence the necessary switch settings and tripping characteristic:

- some switch frame sizes feature optional, separately adjustable *fault current or earth fault protective functions*,
- on all frame sizes personnel protection is implemented by *fast safety disconnection of outgoers and equipment*,
- an additional protective function, the *undervoltage protection*, can be performed by the circuit-breaker if it is equipped with an undervoltage release,
- in this case they simultaneously guarantee the *protection against automatic restart* after an interruption of the voltage supply,
- all *NZM* and *IZM* circuit-breakers presented can provide main switch and isolating characteristics [3, 4].

In the power distribution field, switch-disconnectors and circuit-breakers are generally the most important switching and protective devices. At critical nodes in the electrical power supply which are responsible for the power supply to entire factories or town districts, fuseless protection of the supply by circuit-breakers which are ready to restart quickly without the require-

ment for installation of spare parts are of primary importance. Selective or discriminative protection on various levels of the power network ensures a high level of system and process availability. This is understood to mean that only the protective device in the vicinity of the short-circuit will trip. The following are conventional switchgear combinations to implement selective (discriminative) networks:

- fuse – fuse,
- fuse – circuit-breaker,
- circuit-breaker – fuse,
- circuit-breaker – circuit-breaker.

Figure 4 indicates an example for a network design with time selectivity (time-discriminating), which is achieved by using switches with differing short-time delays for the short-circuit release. *Eaton* helps the practically-minded to find the optimum, selective engineering design – even including designs considering fuses – with the *xSpider* planning software. The *Eaton NZM* and *IZM* circuit-breakers with electronic releases can also be comfortably networked into modern switchgear systems [5]. Dedicated software tools are also available for networking tasks.

Functional areas in the tripping characteristic and the thermal memory of the release

Tripping characteristics indicate multiple function areas of the safety devices. Different releases installed in the same device are partly responsible for the differing functional areas. The

Frame sizes, applications, switching capacity, setting range of the NZM circuit breaker, IEC-version, 3-pole switch								
Type	Electromechanical release					Electronic release		
	Setting ranges in A	IEC switching capacity at 400 V				Setting ranges in A	IEC switching capacity at 400 V	
		B = 25 kA	C = 36 kA	N = 50 kA	H = 150 kA		N = 50 kA	H = 150 kA
NZM..1	-A..	15 - 160	15 - 160	15 - 160	15 - 160 *)	-	-	-
NZM..1	-M..	16 - 100	-	16 - 100	-	-	-	-
NZM..1	-S..	40 - 100	-	40 - 100	40 - 100	-	-	-
NZM..2	-A..	125 - 300	125 - 300	125 - 300	125 - 300	-	-	-
NZM..2	-M..	100 - 200	-	100 - 200	16 - 200	-ME..	45 - 220	45 - 220
NZM..2	-S..	125 - 200	-	125 - 200	40 - 200	-	-	-
NZM..2	-	-	-	-	-	-VE..	50 - 250	50 - 250
NZM..3	-A..	-	260 - 500	260 - 500	260 - 500	-AE..	125 - 630	125 - 630
NZM..3	-	-	-	-	-	-ME..	110 - 450	110 - 450
NZM..3	-	-	-	-	-	-VE..	125 - 630	125 - 630
NZM..4	-	-	-	-	-	-AE..	315 - 1600	315 - 1600
NZM..4	-	-	-	-	-	-ME..	275 - 1400	275 - 1400
NZM..4	-	-	-	-	-	-VE..	315 - 1600	315 - 1600
	-A..	Protection of systems and cables				-AE..	Protection of systems and cables	
	-M..	Motor protection				-ME..	Motor protection	
	-S..	Short-circuit protection (without overload protection)				-VE..	System and cable protection, selective and generator protection	

*) H = 100 kA

Table 1: Overview of the most important selection criteria for the NZM circuit-breakers and the solution with electromechanical or electronic releases.

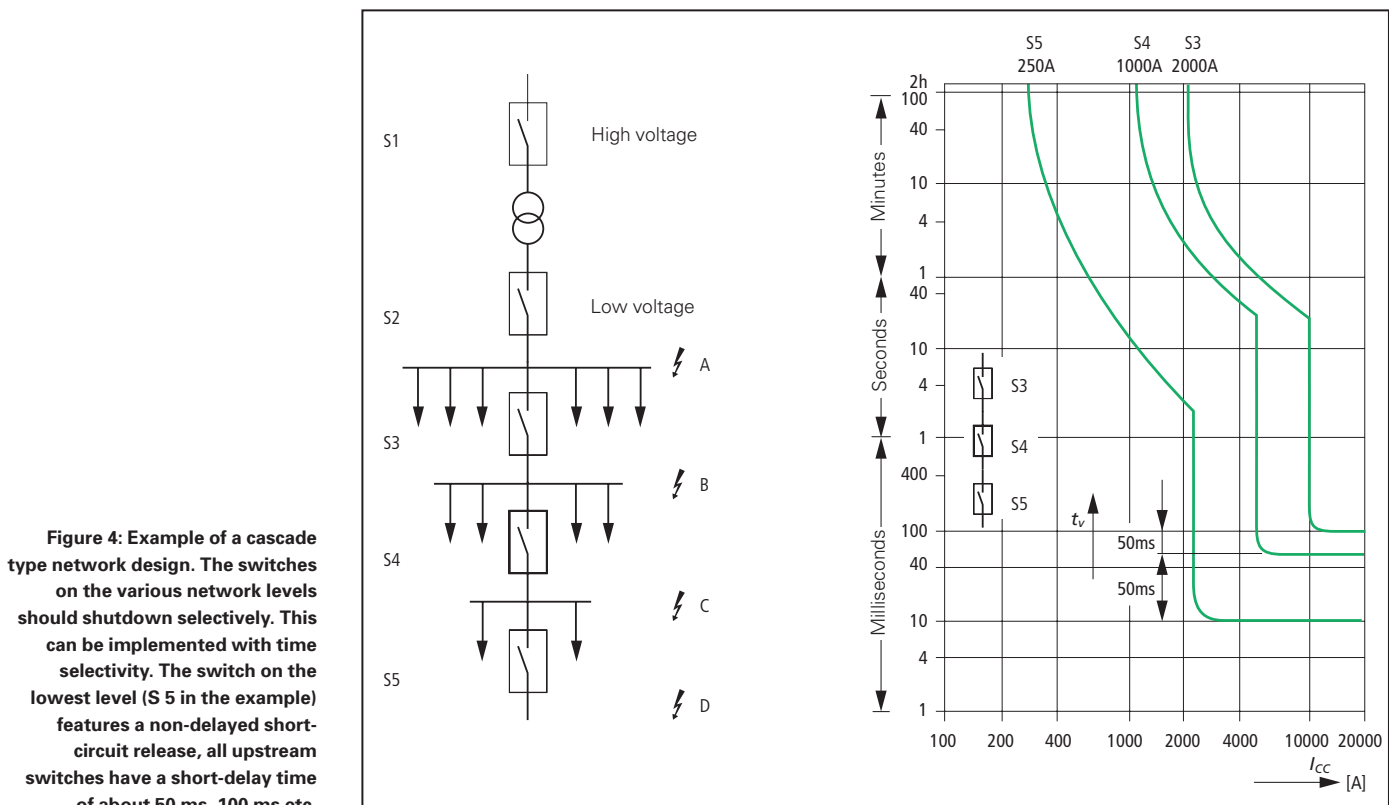

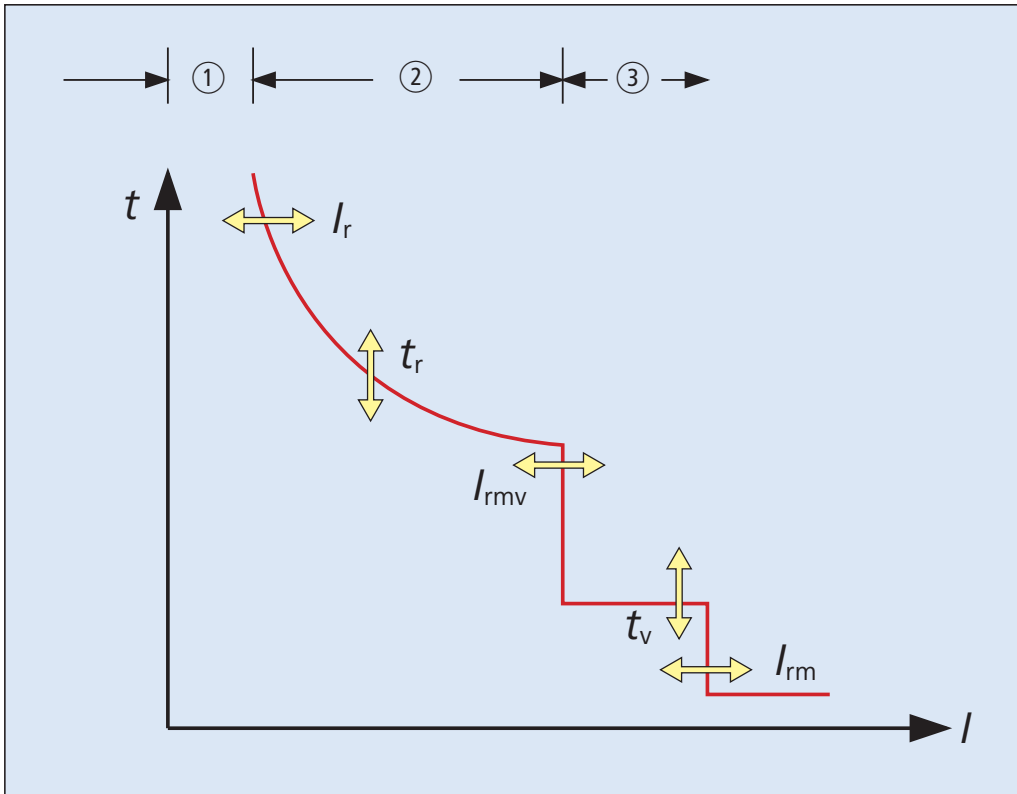

Figure 5: The figure indicates a tripping characteristic with functional ranges
1. Non-trip range / operating range to the left of or under the red tripping characteristic,
2. Overload range, a brief overload is possible,
3. Short-circuit range.
The figure also indicates the variable parameters corresponding to Table 4, which enable application-specific design of the characteristic curve.

tripping characteristic expresses the behaviour of a protective device dependant on the different levels of current flow and the times for which the currents are flowing. The tripping characteristic indicates the behaviour of a circuit-breaker under operational as well as under exceptional conditions. Constructive features of the circuit-breaker can have an influence on the specific tripping characteristic. The tripping characteristic must correspond with the demands of the equipment to be protected. A trip will not occur underneath or left of the tripping characteristic in the controlled admissible range. The current/time field underneath/left of the tripping characteristic can be used operationally (operational conditions). For example, in this range drives will also operate intermittently resulting in a higher current (in the overload range) for a short time. The equipment and the protective devices can cool off in the intermittent pauses. The field above or right of the tripping characteristic indicates the range for exceptional conditions with the faults possible due to an overload or short-circuit. The characteristic is generally represented as a log-log coordinate system. The characteristic covers three ranges as indicated in **Figure 5:**

① Non-trip range

In the first range, the switch will not trip without reason when the equipment is not endangered. For this reason, the switch may not trip within 2 hours (at $I \leq 63$ A, within 1 hour) when started from the cold state, and at the reference temperature when loaded on all poles with up to 1.05 times the current setting I_r for the *current-dependant delayed overload release* (conventional non-tripping current).

② Overload range

The second range is the overload range. In this range the current-dependant thermal (bimetallic) or current-depend-

ant electronic delayed overload release acts. With *NZM* circuit-breakers, the overload releases are always adjustable with the exception of special devices designed for the North American market. The tripping time is long with marginal overcurrents and becomes shorter with larger currents. This characteristic corresponds with the load capability of the equipment to be protected. The permissible overcurrents cannot be increased as required, because the thermal and dynamic loading for the equipment, cabling, switchgear system and switches increase with the square of the current (pay special attention to this fact when engineering for high-inertia motors). The overload range extends up to the application relevant adjustable response range of the magnetic short-circuit instantaneous release (comparable with an emergency brake). The range between factor 1.05 and the factor 1.2 to factor 1.3 current setting value I_r is defined as the current limit range. This range is of particular importance for standard-conform adjustment of the switch during manufacture. With electronic overload releases on the circuit-breakers, e.g. for the motor protection, the position of the curve on the time axis (t) can also be offset to take heavy starting duty into consideration. The set time t_r applies for 6 times the current setting I_r . The designation "tripping class" (Class 5, 10, 20, etc.) is known for a similar function with the electronic motor-protective relay, and allows the max. tripping time at 7.2 times the current setting I_r . On relays the standard setting is Class 10 A with $t_r = 10$ s.

The short-circuit circuit-breakers without overload release are a special type. This switch is to be combined with additional overcurrent protective devices. These combinations are selected for the protection of motors with extended start-up times or when the circuit-breaker is not supposed to trip with a self-correcting overload. This type of switch is found more frequently in North America than in the IEC world.

Suitability for main and secondary applications, of the switch in the IEC version								
Main applications						Secondary application		Type
Short-circuit protection (without overload release)	System protection	Cable protection	Generator protection	Selective protection with delayed short-circuit release	Motor protection	Main switch	Emergency stop	yellow and "E" = electronic release blue = electro-mechan. release
						X	X	N...-
X					(X) *	X	X	NZM...-S..
	X	X				X	X	NZM...(-4)-A..
	X	X				X	X	NZM...(-4)-AE..
					X	(X) **	(X) **	NZM...-M..
					X	(X) **	(X) **	NZM...-ME..
	X	X	X	X		X	X	NZM...(-4)-VE..
* Only in combination with suitable contactor and overload relay ** Only for single motor starter (-4) Type suffix for 4-pole switch								

Table 2: Application dependant main and secondary applications of the NZM circuit-breaker with electromechanical or electronic releases.

③ Short-circuit range

The permissible overload limit for the equipment and the switch are exceeded here. This is where the short-circuit range commences where the non-permissible current should be shutdown as soon as possible. The response value of the short-circuit release I_i (i = instantaneous) is selected as a multiple of the rated current of the switch I_n (highest current setting). This multiple can be set to suit the application, i.e. the type of equipment to be protected. If the rated current of the switch is not fully exploited, the multiple setting at which the switch trips is larger than the multiple setting which is set on the switch. If for example motors are being protected, the response value of the short-circuit release must be selected so that it is not tripped by the inrush current peak (starting current). In this case and for the protection of transformers, it is often more useful when the circuit-breaker is adjusted to the highest level. This offers additional security against premature tripping, which can be particularly important when the response value of a short-circuit release is not adjustable. Depending on the switch type, a differentiation is made between non-delayed (I) and short-time delayed (I_{sd}) short-circuit releases. A short-time delayed short-circuit release is always combined in the same switch with a (higher setting) non-delayed short-circuit release.

With delayed releases, the current and the additional delay time (t_{sd}) must be set to suit the specifications of the equipment to be protected. The delay time starts when the set current of the delayed release is exceeded. Before a trip is initiated, the unit verifies if the set current still exceeds the threshold value. The set delay time is independent of the current. The higher setting on the non-delayed instantaneous short-circuit release (I) trips the switch if its setting value is exceeded during the delay time. The non-delayed short-circuit release is the emergency brake in this combination.

With a cascade-like selective (discriminative) network design, the downstream circuit-breaker in the vicinity of the fault must trip within the delay time of the upstream circuit-breaker in order to reduce/interrupt the current in good time, otherwise there is a danger that the upstream delayed circuit-breaker will also trip. **Always when delayed releases for the circuit-breaker or higher tripping times with overload relays (e.g. Class 40) are used, for example with heavy starting duty of large motors, the design engineer must consider that all devices and cables in the entire circuit are subject to a higher current load for an extended period of time. In such cases, it is frequently the case that the switchgear and the cables must be oversized accordingly.**

An important feature for protection of equipment and cables is the "thermal memory" of the release. The thermal memory simulates the heating effects of the equipment to be protected during normal operation and during the overload phase. It permanently saves the heating factors to ensure that the thermal state of the equipment is still a known factor after trip of a switch or after a voltage loss. This provides the basis for a further, optimum protection feature after an interruption in operation or with an intermittent operational characteristic. The thermal memory takes the typical time constant for cooling of the load (cable or motor) into consideration when dissipating the stored heat which has thermally loaded the cable or motor.

The emulation of the cooling is implemented on the electronic releases using the same time constant with which the heating characteristic is determined. On bimetal releases this function results automatically as the heated bimetals must cool down to return to their initial states. During operation, the thermal memory prevents the load, e.g. a motor, being subject to a thermal overload after an overload release

caused by a restart before it has cooled sufficiently. At the same time, the preheating of the equipment is taken into consideration by the thermal memory if an overload occurs. A restart is only possible when the electronic simulation or the reverse bending process of the bimetals indicates that the motor is sufficiently cool.

If unfavourable cooling conditions are to be expected and the motor heats up more quickly / cools down with a greater delay than considered by the simulation, the motor will require additional protection using a thermistor temperature detector and an *EMT 6* evaluation unit.

Necessity for variable tripping characteristics with modern circuit-breakers

The specific protective tasks and the application related operating conditions (utilization categories) of the stated equipment demand differing switch settings. This relationship leads through the different, adjustable variables to application-specific switch variants, corresponding to those in **Tables 1** and **2**. The demands placed on the spectrum of adjustment possibilities increase when multiple protective devices are connected in series. This is always the case especially when several main distribution and sub-distribution boards are arranged

Different demands placed on the circuit-breaker for system and motor protection

Feature	Protection of systems	Motor protection
Relevant standards	IEC / EN 60 947-1 [6] IEC / EN 60 947-2 [7]	IEC / EN 60 947-1 [6] IEC / EN 60 947-4-1 [8]
Current limit range		
Ambient temperature	Manufacture specified 40 °C (at Eaton)	Standard value 20 °C
Conventional non-tripping current *) for the current dependant delayed trip (May not trip within 2 h **), with load on all poles, at reference temperature)	1.05 x current setting **) 1 h at ≤ 63 A	1.05 x current setting
Conventional tripping current *) for the current dependant delayed trip (Must be within 2 h **), according to load with the non-tripping current)	1.30 x current setting **) 1 h at ≤ 63 A	1.20 x current setting
Single-phasing sensitivity		
Definition: May not trip within 2 h at:	Not intended Not useful as the current loading on the phase can be unbalanced and frequently is	Alternative permissible Useful protective function, as the current distribution of the phases with motors should be symmetric
Must trip within 2 h at:		2 pole 1.0 x current setting, 1 pole 0.9 x current setting
Response range of the short-circuit release (Empirical values) I_r = setting of the overload release		2 pole 1.15 x current setting, 1 pole 0 x current setting
Immunity to starting current	approx. 6...10 x I_r	approx. 8...14 x I_r
Selectivity	Conditional requirement	Required
Overcurrent release	With multiple switches in series usually required	Useful
Tripping class	Must not be adjustable (Always adjustable with NZM and IZM)	Adjustable
Thermal memory	Not intended	Useful For matching to the start-up behaviour of the motor
	Useful	Essential requirement

Table 3: Different demands with both high sales applications of the circuit-breaker, the "protection of systems" conform to IEC / EN 60 947-2 [7] and the "motor protection" conform to IEC / EN 60 947-4-1 [8]

*) Definitions are informative but are only used in the IEC / EN 60 947-2 **) Refer to second column

between the low-voltage incomer transformer and the equipment. In these cases, the switches and the cables and conductors for the individual segments of the circuit must frequently be dimensioned for different current levels. As a result, switches of varying frame size are often connected in series in the current path.

The four listed fields of application place different demands on the switch as indicated in the example for system and motor protection in **Table 3**. The most important application-dependent parameters for the circuit-breaker selection are

- occurrence of a symmetrical or unsymmetrical load,
- different, typical inrush peak currents of the equipment to be protected with their differing current/dynamic response,
- normal operating currents,
- prospective overload currents with their differing current/dynamic response and
- finally, the level of the short-circuit currents which are to be expected.

With the short-circuit currents, it is not only the obvious question that is posed concerning the maximum current levels, but also if the currents expected during a malfunction exceed the overload range in the short-circuit range in order to trip the switch with the necessary speed to prevent damage to the downstream equipment and injury to personnel. The question of adequate current levels is mainly an issue with low-power generators or in circuits with long cable lengths, which result in a high line impedance and a high voltage drop. For this reason, a generator circuit-breaker with a particularly low setting is available. However, fast shutdown during a malfunction is a time-critical operation for personnel protection with the dangerous touch voltages which result. However, during a short-circuit it is possible that unintended high level voltage drops occur which can cause undefined switching states in the contactor relays or on the voltage dependant releases in the system, and which also require a fast short-circuit trip. Under-voltage releases can assist here.

The tool presented in this paper enables simple representation of tripping characteristics, for known (selected) switches on a PC and the simple visual comparison of the characteristic curves of multiple switches and fuses, which are connected in series in the current path at various levels in the network (**Figure 4**). The objective is to verify if the switches provide safe operation and if the selectivity exists between the protective devices used in the overload and short-circuit range. **The most significant advantage of this tool** compared to every printed representation in a catalogue **is that the very specific trip characteristic which takes account of all the actual settings on the switch, can be generated and documented.**

A prerequisite for the correctness of the curve is that identical switch types are selected in the tool and the switchgear system, and that all the switch position settings are correctly entered into the tool. If the tool indicates that modified settings are required on the switch, the required settings must be made manually on the switches. All results can be saved, copied and printed including details for identifying the devices.

In addition to the trip characteristics for the presented *NZM 1* to *NZM 4* compact circuit-breakers, the tool can also display the characteristics for the previous generation of compact devices such as the *NZM 7*, *NZM 10* and *NZM 14*, as well as the *IZM 1* to *IZM 3*, *IZM 20* to *IZM 63*, *IZM X16* open circuit-breakers and the fuses with gI-characteristic. The tool has been

expanded to include further components such as the *PKZM* motor-protective circuit-breaker, miniature circuit-breakers *FAZ* and *ZB* overload relay.

Constants and variables for curve representation

Protective devices with bimetal releases such as the *ZB 12*, *ZB 32*, *ZB 65* or *ZB 150* overload relay only allow for setting of the rated motor current as the current setting I_n of the overload release. The further response characteristic of the trip characteristics is defined in the construction phase by the rating of the bimetal, so that the bimetal characteristic corresponds as accurately as possible to the heat characteristic of the motors. The only non-adjustable side-benefit offered by this variant is a standard-conform single-phasing sensitivity, and all variants feature ambient temperature compensation. They detect and take the failure of any main pole (phase) into consideration. The same applies for *PKE*, *PKZM 01*, *PKZM 0* and *PKZM 4* motor-protective circuit-breakers. On these circuit-breakers the response ranges of the additional short-circuit release are fixed.

Protective devices with electronic releases such as the *NZM 2* to *4* or *IZM 1* to *3*, *IZM X16*, *IZM 20* to *63* offer additional degrees of freedom with the setting and definition of their protective features as well as in conjunction with further protective devices present in the same circuit. **Table 4** indicates effective parameters with differing protective switch types, which are either fixed or variable settings. The opportunity to match these individual settings to the varying equipment is a significant advantage of circuit-breakers in comparison to fuses. An example of the improved protective features by individual adjustable electronic releases is indicated by **Figure 6** which is a typical motor start-up characteristic, which can be represented using the tool, and the protection, on the one hand with a circuit-breaker with thermal overload releases on which a short-circuit release is set to the maximum current, as well as significantly improved protection with circuit-breaker electronic releases on the other hand. In the first case, the peak inrush current can still cause a trip release of the switch. In the second case the motor has better protection during run-up.

The adjustable fault current or earth-fault releases are optional accessories which are not considered in the characteristics program. As already described, the short-time delayed switch enables the implementation of a time-discriminating system concept. The short-time delayed releases are also used on motors with extended run-up times. In this application the protective function can be extended to include the additional *EMT6* thermistor machine protection relay from *Eaton*.

Handling of the Eaton "CurveSelect" software tool

Up to now, it was difficult to represent individual characteristic curves and to compare them with one another. Quiet often the comparison failed due to the differing scales for the representation of the coordinates of the curves for circuit-breakers and fuses. This has now changed with the software tool. All curves are now displayed on a single sheet enabling simple visual evaluation.

The handling is very simple as the user is offered the permissible variables in the type-specific input sheets. He simply has to enter the respective variable manually into the mask. The pro-

Setting possibilities with current-dependant acting releases with different circuit-breaker types

		The releases can be optionally available or the specifications only apply with certain switch variants, see latest Eaton main catalogue Industrial Switchgear						
		Electromechanical release				Electronic release		
Parameters with influence on the tripping characteristic	Type	ZB...	PKZM...	PKZ...	NZM...	NZM...	IzM...	
	Size	12, 32, 65, 150	01, 0, 4	2	1, 2	2	3, 4	1, 2, 3
Setting I_i for overload release		var.	var.	var.	var.	var.	var.	
Response value I_{rm} for instantaneous short-circuit release		-	fixed	var.	fixed	-	-	
Response value I_i for instantaneous short-circuit release		-	-	-	-	fixed	fixed	
Response value I_{sd} for delayed short-circuit release		-	-	-	-	var.	var.	
Motor protection tripping class CLASS		fixed	fixed	fixed	fixed	var.	-	
Time delay setting to overcome current peaks t_i for overload release		-	-	-	-	fixed	fixed	
Delay time t_{sd} for short delayed short-circuit release		-	-	-	-	var.	var.	
I^2t -constant function		-	-	-	-	fixed	fixed	
Single-phasing sensitivity		fixed	fixed	fixed	fixed	fixed	fixed	
Rated fault current I_{An}		-	-	-	-	fixed	-	
Delay time t_i for residual-current release		-	-	-	-	var.	-	
Response value I_g for earth-fault release		-	-	-	-	fixed	-	
Delay time t_g for earth-fault release		-	-	-	-	var.	var.	

Table 4: Fixed and variable parameters for current-dependant acting releases with different circuit-breaker types.

gram is available for download on the Internet at <http://www.eaton.eu/Europe/Electrical/CustomerSupport/Configuration-Tools/CharacteristicsProgram/index.htm>. Free of charge registration is required with the program.

- The program is copied onto a PC as an Excel file on which Microsoft Excel® is already installed.** Further installation is not required. The file can be used for as many projects are required.
- The file is opened by a double-click on "Kennlinien... .xls".**

An Excel worksheet opens with the multiple sheets required for the necessary inputs and the representation of the curves.

- Comprehensive, advanced information about the program is contained in the "Read Me" sheet.
- The required language versions can be selected in the "General" sheet. On this sheet "General details" of the project are entered and are automatically accepted into the representation of the characteristic curves.**

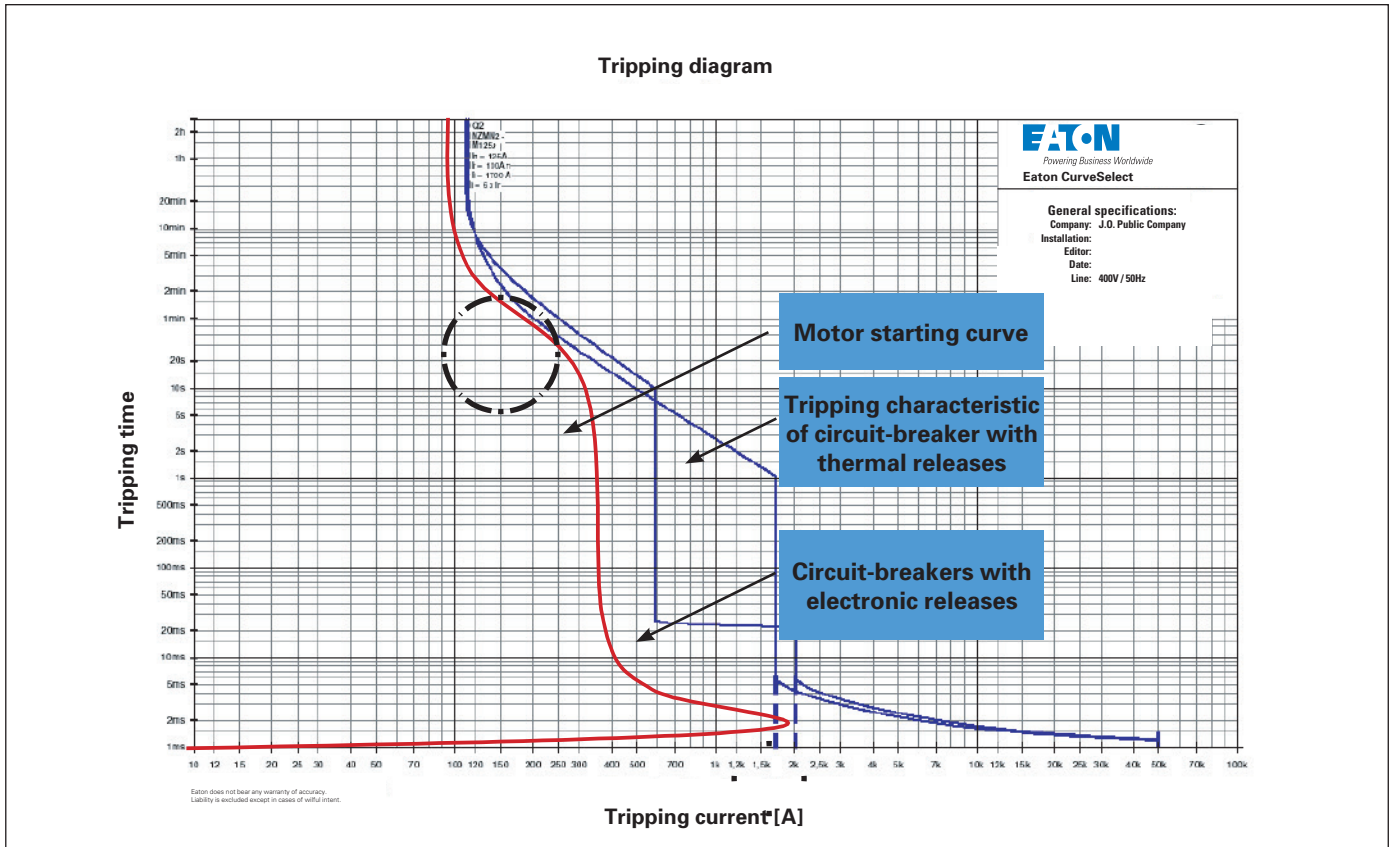

Figure 6: Circuit-breakers with electronic releases enable – by flexible setting features – a more exact matching to the typical current consumption curve of a starting three-phase motor than is possible with the switch on thermal overload releases.

With the actual program, it is only currently possible to use applications with an operating voltage of between 240 and 690 V, 50...60 Hz.

- It is recommended that you save the program after entering the basic program data in any desired folder with "File" / "Save as".**

This ensures that the original program file "Kennlinien... .xls" is available for further use and does not contain project-specific entries. It is also recommended that you save further entries regularly with "File" / "Save as".

- With the worksheets "NZM...", "IZM...", "PKZ...", "ZB", "MCB" circuit-breakers or "Fuses" you can select the protective device whose characteristic curve you want to represent next.**

Per sheet and project it is possible to register the data for 2 to 3 protective devices of the same construction type and size in the "Input" fields. Every product sheet is used a maximum of once per project. All entries can be erased or overwritten if required. The respective permissible entries are provided corresponding to the selected basic type in the "Permissible setting range" field. The permissible values can be copied and must be entered manually into the input fields. Invalid entries are indicated in the "Errors" field. If possible, an information display indicating "Control and limit values" and "Warnings" will be indicated if necessary.

Each tripping characteristic can only be graphically represented when the device has been assigned with a designation in the "Designation" field.

- On the worksheets "FSC" (Free style curves) and "Mot" (Motor curves) the freely definable characteristics for protective devices or for a motor run-up curve are entered.** Refer to the Read_Me file for further information concerning the handling of the freely definable curves. The freestyle curves are multiple usage oriented and can be reused by simply saving the project under different names.

After entering the data for the first protective device and after each further input, the tripping characteristic(s) are displayed on the "Tripping graphs <> Curves" (Figure 1). Subsequent changes to the entries on the "Product sheets" are automatically considered by the next curve display. The representation is made on a log-log coordinate system with 5 x 7 decades, from 1 A to 100 kA and from 1 ms to 2 h, and as absolute values.

- The entire worksheet or just the "Characteristics <> Curves" can be printed.** The project related data can be displayed, edited and printed on every computer where Excel is installed. The "Characteristics <> Curves" worksheet can be marked and copied into the computer clipboard and then inserted into other documents. After modifications on the input sheets, the "Characteristics <> Curves" sheet must be copied and inserted again if required.
- After completion of the project specific file, it can be protected by the write protect feature in Windows Explorer® if required. (Locate and mark the file in Windows Explorer and then protect with "Properties" / "Attributes" / "Read-

Only".) It is recommended that you save the "Characteristics <> Curves" individually with a suitable software package as a PDF file and to write-protect it if necessary. This saves memory in the project folder and the document can be protected against subsequent modifications.

- The following limiting conditions must be observed with the evaluation of the diagrams:

All curves are represented assuming the cold state and without representation of the standard-conform tolerances of the response ranges, and the tripping times are represented as mean values of the parameterized tripping characteristic. This representation corresponds with the characteristics represented in the catalogues. In the non-delayed overload release range, the minimum command duration is indicated as it is the time for which the current must flow before an irreversible trip is initiated. This corresponds to the melting time (minimum melting curve) with fuses. The current, voltage and the phase position dependent total opening delay, which is comprised of the response delay, switching delay and arc quenching time is not considered by the represented curves.

- In order to ensure selectivity (discrimination) in the overload range, the curves represented for the circuit-breaker under one another, and the curves for the fuses may not cross or touch each other at any point. Consider the tolerances of the curves which are $\pm 20\%$ in the overload range. The overload selectivity (discrimination) of the selected devices has been reached at the meeting and crossover points.

In the short-circuit range, the electrodynamic processes which are dependent on the individual switch construction play an important role. The current limiting properties of the circuit-breaker, owing to the electrodynamic

effects on the contacts and quenching systems, can not be calculated with justifiable effort by this simple tool in the high current range. The range of this electro-dynamic limit is represented on the diagram by the response value of the non-delayed overload release using a dashed vertical line (**Figure 7**). The short-circuit selectivity is verified by comprehensive short-circuit testing in the test laboratory. For this range the details concerning the selectivity in the selectivity tables in the Eaton main catalogue Industrial Switchgear are obligatory. The characteristic of the respective circuit-breaker ends with the value of the ultimate short-circuit breaking capacity I_{cu} which depends on the device type and rated voltage.

- Selectivity problems can normally be remedied by selecting another device or sometimes by modified device settings (**Figures 8 and 9**).

Enhanced protection in marginal conditions

At the end of the nineties, *Eaton* introduced the protection systems cone model for representation of the systematics with the protective systems [9]. *Eaton* arranges well known as well as innovative protection systems to the standard definitions or selfcreated definitions corresponding with **Figure 10**.

Definitions such as *personnel protection*, *protection for special workshops and areas* as well as *protection of equipment* and the *protection of systems* are generally well known. However new definitions are *equipment basic protection* and *system functional protection*. In the system protection field, Eaton has taken an indisputable lead with a new technology which has not been challenged to date. The new protection system which evolved and is already into its second generation is the highly successful *ARCON*[®] arc-fault protection system. The protec-

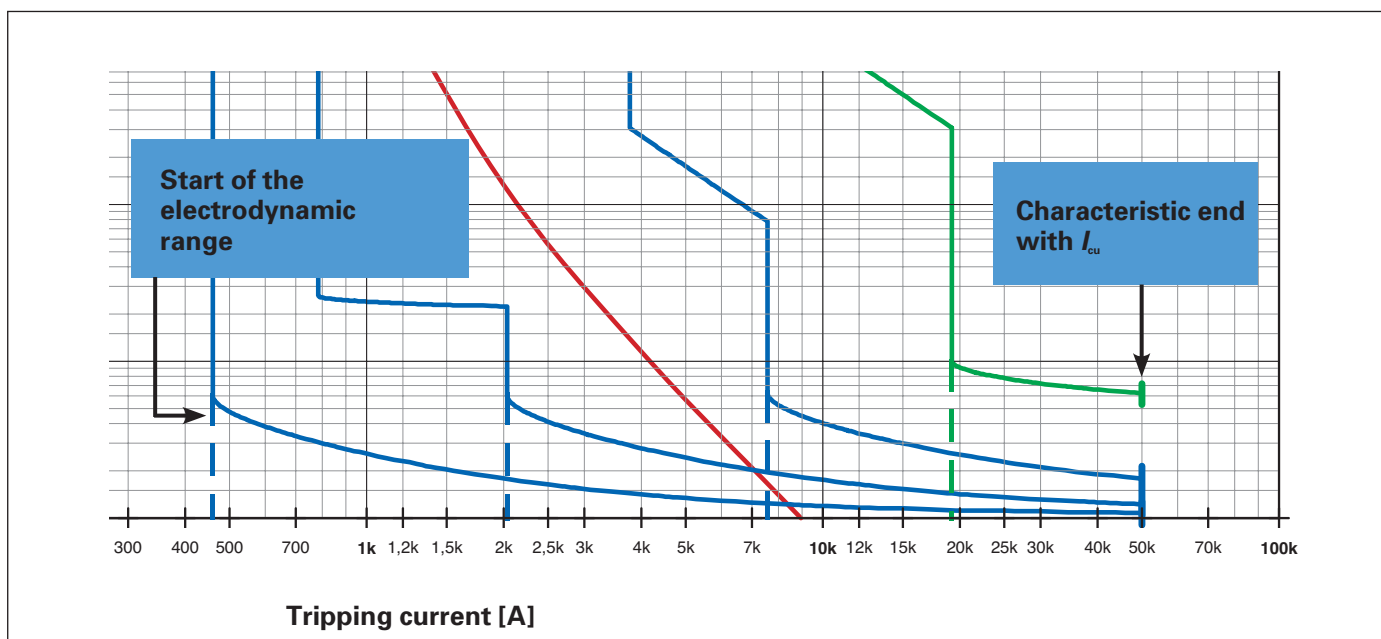

Figure 7: On the lower end range of the curves, a dynamic behaviour of the switch cannot be calculated with a reasonable amount of effort. For a binding statement regarding selectivity in this range, you are referred to the test results in the selectivity table in the Eaton main catalogue Industrial Switchgear.

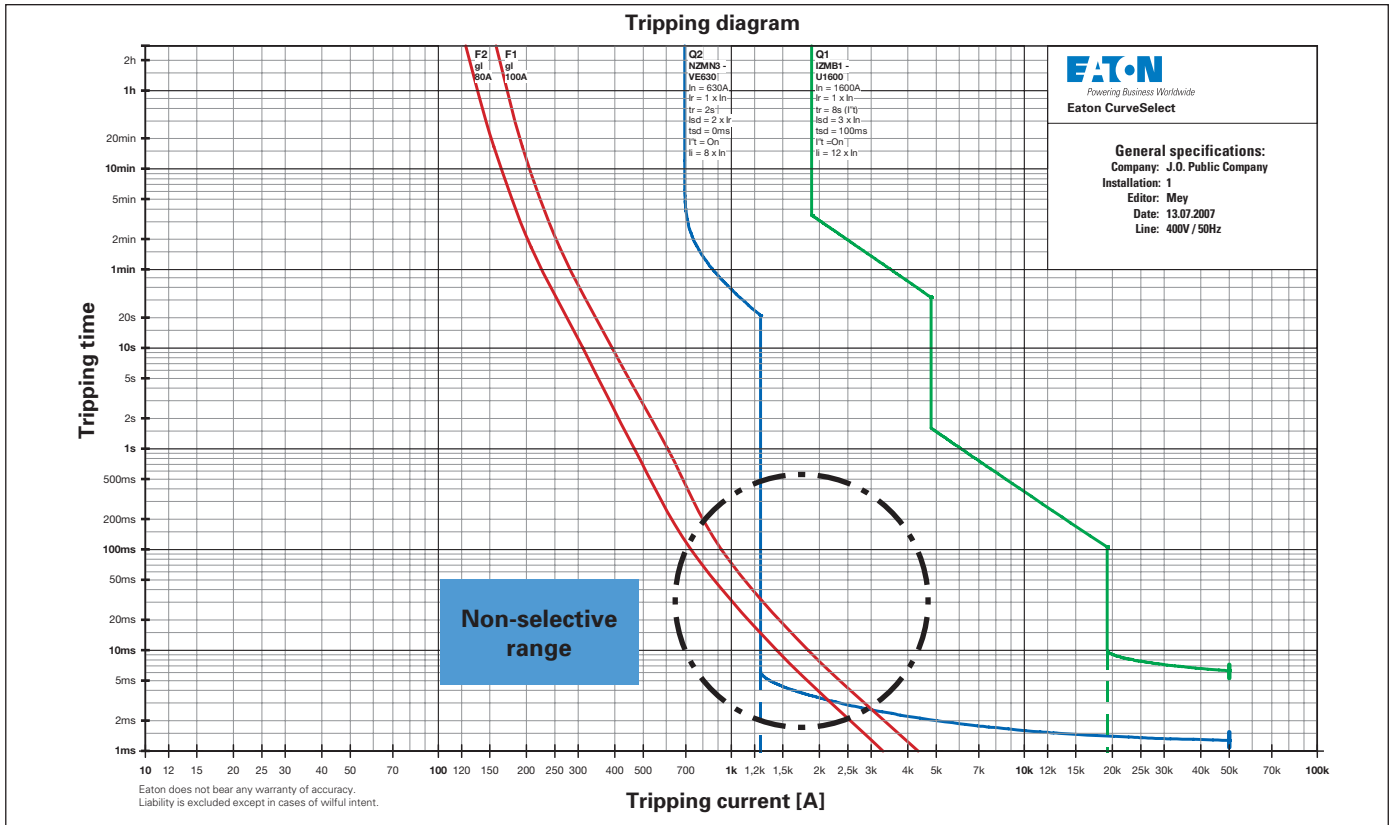

Figure 8: Non-selective protective devices can be recognised by crossover or (almost) touching curves. The green curve represents an IZM outgoing circuit-breaker in a distribution board. The NZM incoming circuit-breaker of a downstream sub-distribution is represented in blue. In this distribution circuit the fuses indicated in red are intended to protect various motor starters with overload relays.

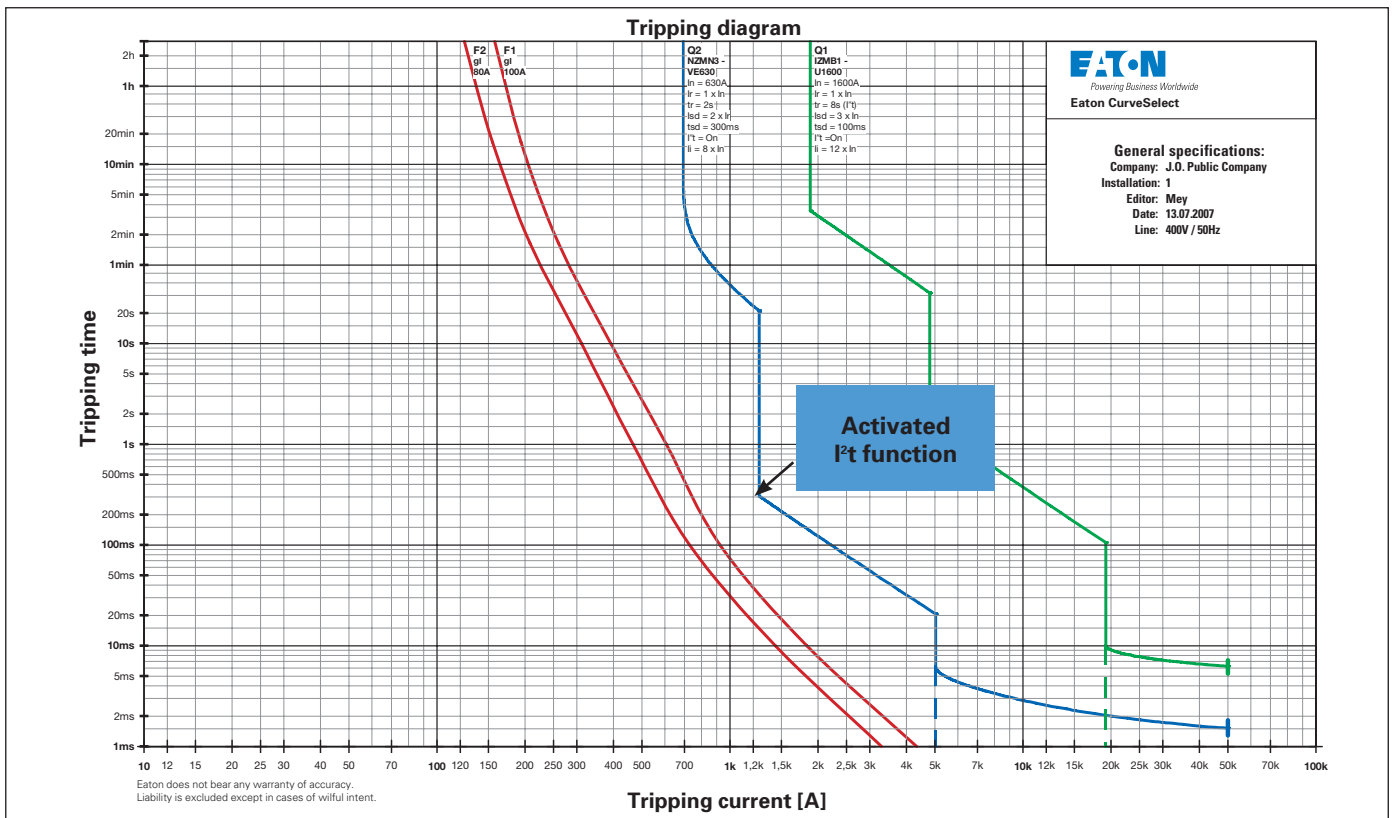

Figure 9: In contrast to Figure 8, the circuit-breaker represented in blue has been reselected. The modified settings provide selectivity in the overload and short-circuit range. The selectivity which is evident in the short-circuit range is confirmed by the selectivity specifications in the main catalogue Industrial Switchgear. The I^2t function can be switched on and off. It improves the selectivity with fuses.

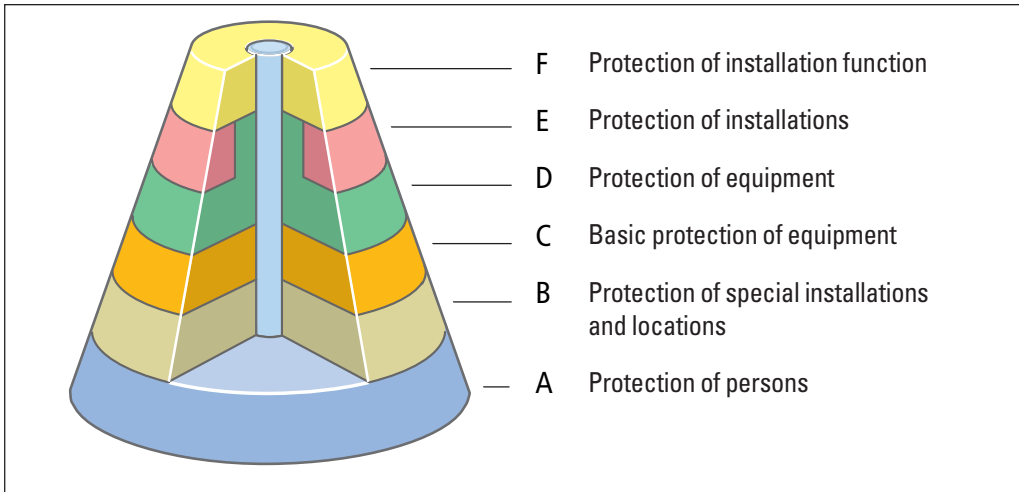

Figure 10: Eaton represents the different protection systems in low-voltage engineering as a cone-shaped model. The functions and systems of functional protection extend beyond the functions of the circuit-breakers presented. Eaton solves these demands for example with the unique ARCON® arc-fault protection system.

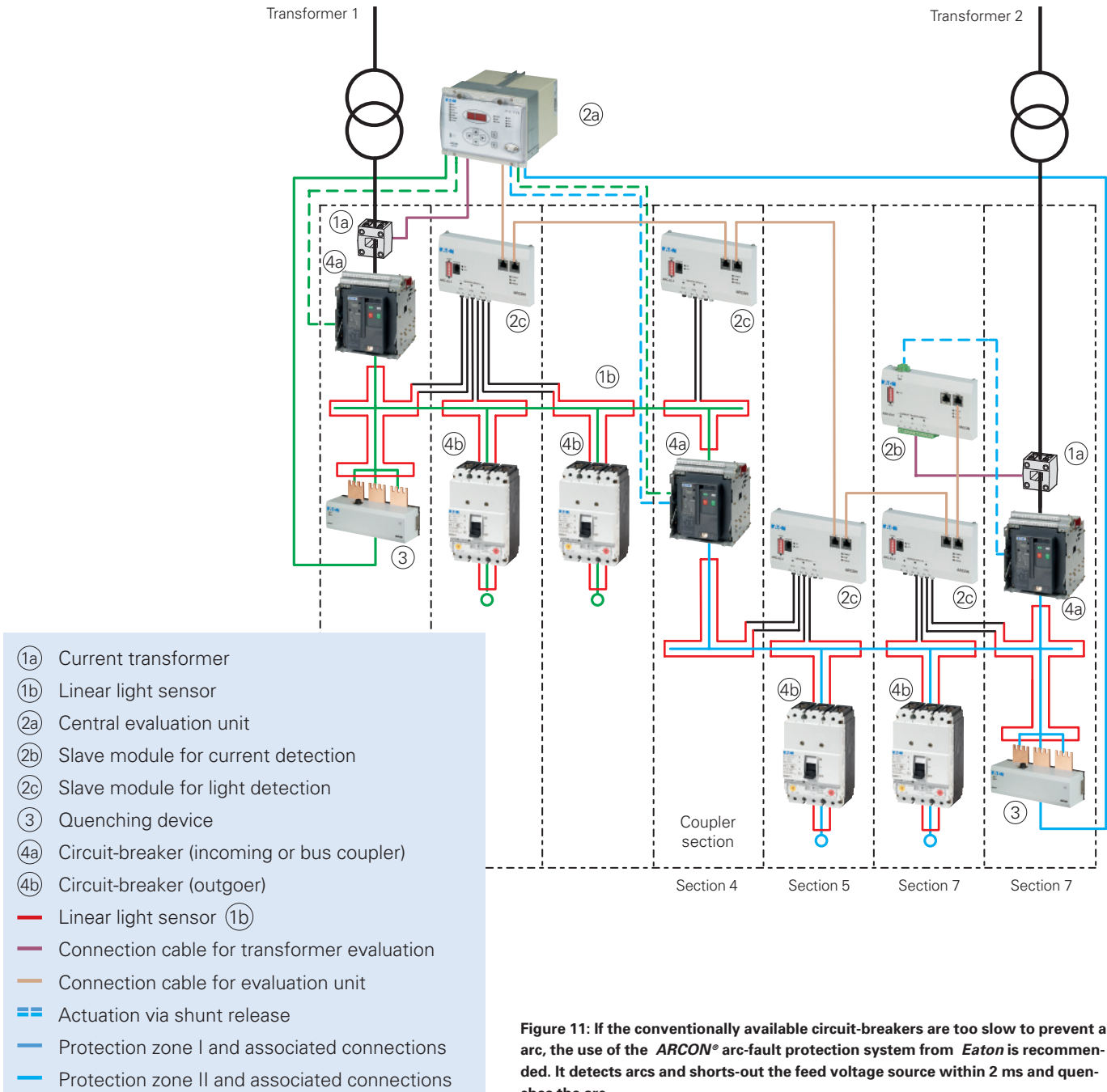

Figure 11: If the conventionally available circuit-breakers are too slow to prevent an arc, the use of the ARCON® arc-fault protection system from Eaton is recommended. It detects arcs and shorts-out the feed voltage source within 2 ms and quenches the arc.

tion systems envisioned for the very high demands placed in terms of avoidance of damage to systems and protection of personnel as well as assurance of an exceptional level of system availability, could not be achieved as the systems were simply too slow. Mastery of the destructive arc requires its quenching within the first two milliseconds of occurrence. On the *ARCON*[®] system, the mains voltage which feeds the arc is short-circuited in less than 2 milli-seconds by a pyrotechnic based short-circuiting element (**Figure 11**) should an arc occur. The conventional circuit-breakers simply have "just" the task of disconnecting the switchgear system from the mains supply within the normal circuit-breaker related switching times. With this system, the damage to the switchgear system has been reduced demonstrably to contamination of the system with dirt, or in the worst case to damage of a fraction of the distribution section. The total failure of a switchgear system is reduced to an interruption in operation of a matter of hours. Further literature presents this unique system in detail [9 to 13]. Its effect extends beyond the protective functions which can be presented with the features of the "CurveSelect" software tool. *ARCON*[®] is also worth mentioning, because the protective functions were difficult to designate in the previous paragraph due to the extremely short time range and extremely high currents involved at the same time. This relates only to the features of the presented tool, and does not mean that *Eaton* could not master this difficult task.

Reliability:

The paper describes the status of the standards and the state of development of the *NZM* circuit-breaker, as well as version V1.22 of the *CurveSelect* software tool. The basis for the technical data for the described *Eaton* products Moeller series[®] is the relevant valid *Eaton* main catalogue Industrial Switchgear. Product information from company Jean Müller, Eltville have been used as the basis for the fuse characteristics. Subject to change without notice.

Acknowledgement:

The paper was completed with the friendly support of the developers of the circuit-breaker control units and the characteristics software, Mr. Gerd Schmitz and Mr. Alexander Zumbek, as well as Mr. Udo Theis from circuit-breaker product support.

Literature:

- [1] Wolfgang Esser
"Main areas of application of circuit-breakers"
Elektropraktiker, Huss-Medien GmbH Berlin,
ep Issue 9-2003 (German language)
- [2] IEC / EN 60 364-4-41, amended or DIN VDE 0100-410
"Erection of power installations with nominal voltages
up to 1000 V, Part 4-41: Protection for safety, Protection
against electric shock"
(2007-06-00)
- [3] Wolfgang Esser,
"Switching and protective devices in machine controls"
Elektropraktiker, Huss-Medien GmbH Berlin, ep Issue
11-2003 (German language)
- [4] IEC / EN 60 204-1, "Safety of machinery , Electrical
equipment of machines , Part 1 General requirements"
(2005-10-00)
- [5] Wolfgang Esser,
"The growing importance of communication with
circuit-breakers"
Elektropraktiker, Huss-Medien GmbH Berlin,
ep Heft 1-2003, (German language)
Special print VER 1230-930 D, Moeller GmbH
- [6] IEC / EN 60 947-1, DIN VDE 0660 Part 100 „Low-voltage
switchgear and controlgear, Part 1, General rules“
(2011-10-00)
- [7] IEC / EN 60 947-2, VDE 0660 Part 101 "Low-voltage
switchgear and controlgear, Part 2: Circuit-breakers"
(2014-01-00)
- [8] IEC / EN 60 947-4-1, DIN VDE 0660 Part 102
„Low-voltage switchgear and controlgear,
Part 4-1: Contactors and motor-starters -
Electromechanical contactors and motor-starters“
(2011-01-00)
- [9] Wolfgang Esser
"Systematics of the protection systems in low-voltage
engineering
– The protective system cone model –
TB 0200-023 D or GB
Moeller GmbH, Bonn, 1998
- [10] Peter-Lorenz Könen,
Dr. H.Schäfer
"Arc-fault protection on low- voltage applications –
a challenge for protection engineering –
VER 27-869 (German language)
Moeller GmbH, Bonn 1998
- [11] Peter-Lorenz Könen
"Protection of persons and systems with an arc"
„etz“ Issue 15 /2003 (German language)
- [12] System information
"Power Reliably Available and Safely Under Control"
W 4600-7542
Moeller GmbH, Bonn, 2003
- [13] Product Information
"ARCON[®] – The Lightning Fast Airbag for Your Switch-
board"
ARCON[®] Arc Fault Protection System
W4600-7560GB
Article No. 285245
Moeller GmbH, Bonn 2007

Eaton is dedicated to ensuring that reliable, efficient and safe power is available when it's needed most. With unparalleled knowledge of electrical power management across industries, experts at Eaton deliver customized, integrated solutions to solve our customers' most critical challenges.

Our focus is on delivering the right solution for the application. But, decision makers demand more than just innovative products. They turn to Eaton for an unwavering commitment to personal support that makes customer success a top priority. For more information, **visit www.eaton.eu/electrical**.

To contact an Eaton salesperson or local distributor/agent, please visit www.eaton.eu/electrical/customersupport