

First half of 2024



New products and innovations

Toolholding and Workholding
Gripping technology
Automation technology
Depaneling technology

Hand in hand for tomorrow



Machine Tending

Increasing variance, ever smaller batch sizes, fluctuating demand and increasing global competitive pressure are just some of the reasons why companies have to think more and more about automated loading and unloading of machine tools, in addition to issues such as a shortage of skilled workers due to demographic change, but also continuous process optimization with the help of current technologies. SCHUNK is the right partner for increasing the productivity of your machine tool.

Find the right type of automation for your production now with SCHUNK!

[schunk.com/
machine-tending](https://schunk.com/machine-tending)

Your advantages of Machine Tending:

- + Increase in productivity
- + Increase in flexibility
- + Process safety
- + Constant quality

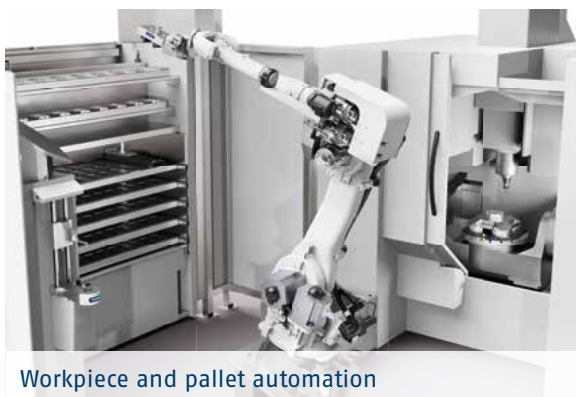

Connectivity

Network production already starts on a small scale, with the component. Smart manufacturing components make a significant contribution to efficient, more sustainable and transparent processes.

At SCHUNK you will receive a variety of actuator and sensory clamping systems, flexible grippers with intelligent connection, and smart automation components. Just contact us. We are happy to help you to make your production fit for the future.

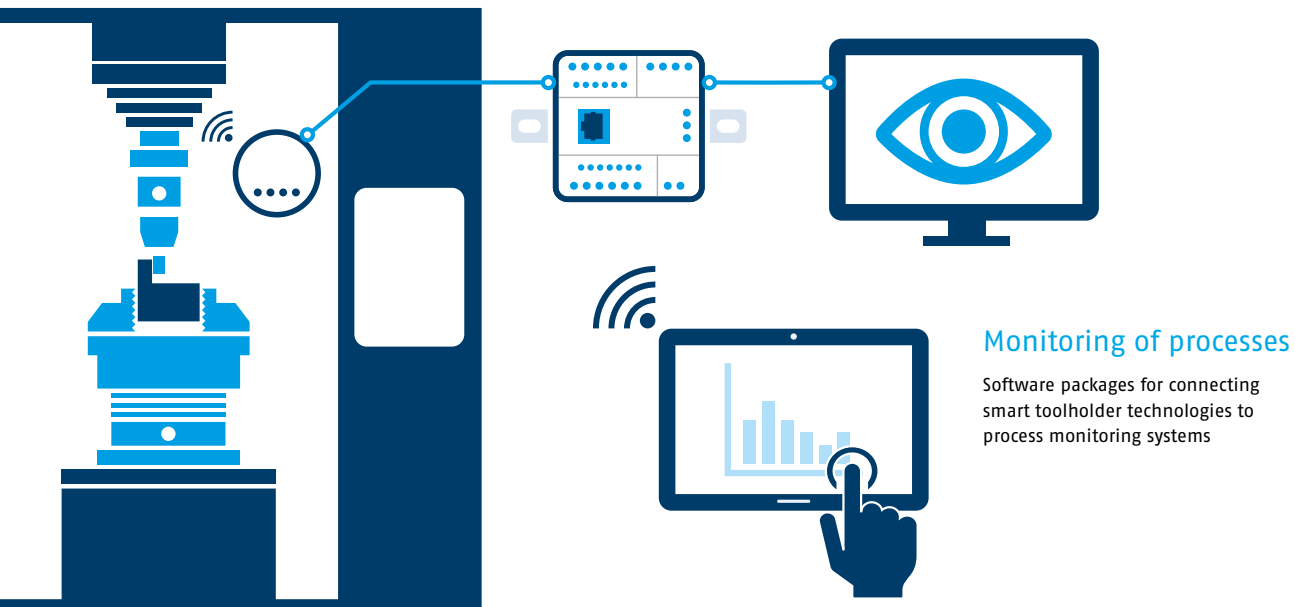

Mechatronic gripper

Gripper for flexible and easy connection with robot and machine control units



Sensory toolholder

Intelligent real-time sensor system for process monitoring and maximizing tool service life



Clamping force block

with integrated sensor system for process monitoring

Intelligence

AI will change our economy, our working world and our way of life – the transformation has long since begun. This is why SCHUNK is actively involved in networks and digitalization initiatives. An example for this includes the project participation in the Innovation Park Artificial Intelligence (IpaI) in Heilbronn and the pushing forward of the Manufacturing-X initiative of the Industry 4.0 platform. In addition to memberships in national and international associations and industrial networks, SCHUNK also cultivates numerous partnerships with universities and technical and scientific institutes. This means that customers can benefit from knowledge and experience and embark on the way towards automation with the help of gripping technology, robotics and artificial intelligence.

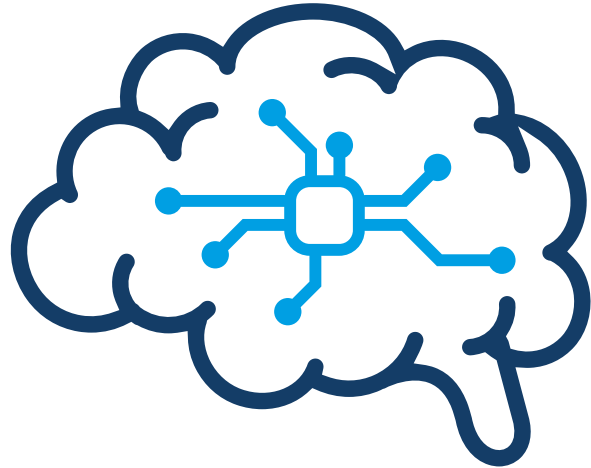

2D Grasping Kit

Intelligent application kit for vision-based gripping

With the 2D Grasping Kit, users from different industries can implement Pick & Place applications of randomly arranged parts on one level – for example from a vibrating table, conveyor belt or load carrier.

The metalworking industry, the automotive sector, companies in production engineering and logistics as well as from the life-science sector gain reliability, process precision and benefit from increasing their output using the kit – manual, error-prone handling thus becomes a thing of the past.



- + Easy component teaching**
Possible without prior knowledge in programming image processing systems
- + Automated grasp planning**
The software determines the gripping points independently
- + Intuitive user interface**
Easy commissioning without prior knowledge thanks to guided software

Content

	Page
Tool clamping technology	6
Workpiece clamping technology	12
Gripping technology	22
Automation technology	30
Depaneling technology	34

Discover our top new products:



iTENDO² easy connect & easy monitor

Page 7



KONTEC configurator

Page 21

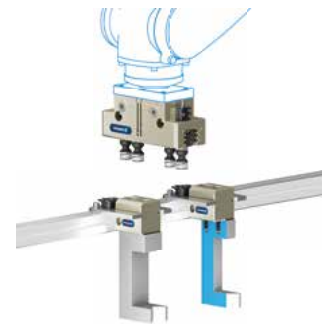

BSWS-R automatic jaw quick-change system

Page 25



RCG round cell gripper

Page 29

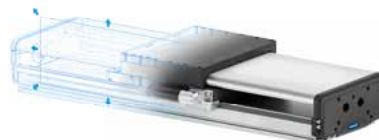

Linear module configurator

Page 33



Inline depaneling machine ILR-Performance

Page 35

Intelligent hydraulic expansion toolholders

The smart way to the optimal process



- + **Intelligent real-time sensor system**
 easy process monitoring and maximizing service lives
- + **Speeds of rotation up to 30,000 RPM**
 wide range of uses in many applications
- + **100% compatibility**
 1:1 interchangeable with SCHUNK standard toolholders without time-consuming reprogramming of your system

- 1 Case**
 All components can be protected during storage and it offers highly flexible transportation to the machine also in case of temporary process monitoring.
- 2 iTENDO² pad**
 Direct connection to the tablet PC without machine connection and simple process optimization.





New interfaces
 HSK-A63 Ø20x90
 HSK-A63 Ø32x125
 HSK-A63 Slim 4ax
 HSK-A100 Ø32x115
 BT30 Ø20x90
 BT40 Ø20x110
 SK40 Ø20x110
 SK50 Ø32x103.2
 CAT40 Ø3/4x4"
 CAPTO C6 Ø32x110
 Adapter Ø20



Battery service life
 10 h



Acceleration sensor
 100 G



Speed of rotation
 30000 RPM



Balancing grade
 G2.5 at
 25000 RPM or
 U_{max} <1 gmm



**External cooling/
 internal cooling**
 up to 80 bar

iTENDO² packages

Packages	Process transparency	Process optimization	Simple data interface	Wireless receiver	Process monitoring	Quality monitoring
iTENDO ² pad	●	●				
iTENDO ² easy connect	●	●	●	●		
iTENDO ² easy monitor	●	●	●	●	●	●

easy connect & easy monitor

Packages for machine integration and easy process monitoring

iTENDO² easy monitor

The simple, universally applicable monitoring for your process

iTENDO² pad

Optimization of processes



iTENDO² easy connect

The easy connection of smart toolholder technology to your process monitoring system

- + Easy connection**
of the smart toolholder iTENDO² to the machine
- + Advanced data collection**
"closest to the part" for your existing system
- + High data quality**
by direct recording of process data on the last non-wearable part
- + Intuitive operability**
through a convenient user interface

schunk.com/itendo2

iTENDO² magnetic holder

with intelligent real-time sensor system



- + iTENDO² technology**
easy to use for tests and process optimization
- + High level of flexibility**
fasten magnetically or with screws to static elements in the workspace
- + 100% compatibility**
with all iTENDO² packages: prerequisite is an iTENDO² pad or easy connect

T|E|N|D|O® Silver Hydraulic expansion toolholders

NEW

For a price-attractive entry into hydraulic expansion technology



- 1 Clamping screw**
The clamping screw is used to actuate the clamping piston
- 2 Clamping piston**
The clamping piston compresses the hydraulic medium into the chamber system
- 3 Sealing element**
Special sealing for leakage-free clamping
- 4 Expansion sleeve**
The expansion sleeve evenly expands against the tool shank
- 5 Chamber system**
It has a damping effect on the clamped tool
- 6 Base body**
With machine interface
- 7 Tool**
Maximum run-out and repeat accuracy < 0.003 mm

- + All commercially available tool shank types can be clamped**
Form A: with smooth cylindrical shank, Shank Form A in accordance with DIN 1835 and DIN 6585 HA
Form AB: with flat face and cylindrical shank with pulling face, Shank Form B in accordance with DIN 1835 and DIN 6535 HB
Form B: with lateral pulling faces, Shank Form B in accordance with DIN 1835
Form E: with inclined clamping face, Shank Form E in accordance with DIN 1835 and DIN 6535

- + Fine-balanced by default**
Suitable for high speeds with a balancing grade of G2.5 at 25,000 RPM

- + Micron-precise tool change in seconds without peripheral equipment**
Time saving through reduction of set-up time and no investment and energy costs due to additional clamping devices



Interfaces

CAT 40
CAT 50
HSK-A 63
HSK-A 100
SK 40
SK 50
JIS-BT 30
JIS-BT 40
JIS-BT 50



Run-out accuracy
≤ 3 μ



Min. torque
16 .. 650 Nm



Max. speed of rotation
25000 .. 50000 RPM



Diameter
6 .. 32 mm
1/4 .. 1 1/4 "

schunk.com/tendosilver

Technical data

Series	Clamping diameter [mm/inch]	Run-out accuracy	Min. torque [Nm]	Bore hole for data carriers
TENDO Silver CAT 40	6 .. 20 / 1/4" .. 3/4"	< 0.003 mm at 2.5 x D	16 .. 330	Standard
TENDO Silver CAT 40 L1=4"	6 .. 32 / 1/4" .. 1 1/4"	< 0.003 mm at 2.5 x D	16 .. 650	Standard
TENDO Silver CAT 50	12 .. 32 / 1 1/4"	< 0.003 mm at 2.5 x D	90 .. 650	Standard
TENDO Silver HSK-A 63	6 .. 32	< 0.003 mm at 2.5 x D	16 .. 650	in accordance with DIN 69873
TENDO Silver HSK-A 100	6 .. 32	< 0.003 mm at 2.5 x D	16 .. 650	in accordance with DIN 69873
TENDO Silver SK 40	6 .. 32	< 0.003 mm at 2.5 x D	23 .. 650	Optional
TENDO Silver SK 50	12 .. 32	< 0.003 mm at 2.5 x D	90 .. 650	Optional
TENDO Silver JIS-BT 30	6 .. 20	< 0.003 mm at 2.5 x D	16 .. 330	Optional
TENDO Silver JIS-BT 40	6 .. 32	< 0.003 mm at 2.5 x D	16 .. 650	Optional
TENDO Silver JIS-BT 50	12 .. 32	< 0.003 mm at 2.5 x D	90 .. 650	Optional

TENDO Slim 4ax Hydraulic expansion toolholders

The world's first hydraulic expansion toolholder
in standardized heat shrinking contour



- +** Permanent run-out and repeat accuracy ≤ 0.003 mm
Even cutting action, increased tool service life, and reduced costs for regrinding or buying new tools
- +** Plug & Work
Can be used in existing processes without reprogramming
- +** Micron-precise tool change within seconds without peripheral equipment
Time saving through set-up time reduction and no investment and energy costs due to additional clamping devices

New interfaces
HSK-A 100
JIS-BT 30
SCHUNK CAPTO C6
SK 50

Run-out accuracy
 ≤ 0.003 mm
at 2.5 x D

Min. torque
16 .. 330 Nm

Max. speed of rotation
30000 .. 50000 RPM

Diameter
6 .. 20 mm

- 1 Chamber system
- 2 Expansion sleeve
- 3 Base body
- 4 Length adjustment screw



schunk.com/tendo-slim-4ax

Technical data

Series	Clamping diameter [mm]	Run-out accuracy	Min. torque [Nm]	Max. speed of rotation [RPM]	Admiss. radial force [N]	MQL (Minimal Quantity Lubrication)	Hole for data carrier
HSK-A 63	$\emptyset 6 - \emptyset 20$	≤ 0.003 mm at 2.5 x D	16 - 330	30000 - 50000	113 - 1490	Yes	Standard
HSK-A 100	$\emptyset 6 - \emptyset 20$	≤ 0.003 mm at 2.5 x D	16 - 330	30000 - 50000	113 - 1490	Yes	Standard
SK 40	$\emptyset 6 - \emptyset 20$	≤ 0.003 mm at 2.5 x D	16 - 330	30000 - 50000	113 - 1490		Optional
SK 50	$\emptyset 6 - \emptyset 20$	≤ 0.003 mm at 2.5 x D	16 - 330	30000 - 50000	113 - 1490		Optional
JIS-BT 30	$\emptyset 6 - \emptyset 20$	≤ 0.003 mm at 2.5 x D	16 - 330	30000 - 50000	113 - 1490		Optional
JIS-BT 40	$\emptyset 6 - \emptyset 20$	≤ 0.003 mm at 2.5 x D	16 - 330	30000 - 50000	113 - 1490		Optional
SCHUNK CAPTO C6	$\emptyset 6 - \emptyset 20$	≤ 0.003 mm at 2.5 x D	16 - 330	30000 - 50000	113 - 1490		Optional
CAT 40*	$\emptyset 6 - \emptyset 20$	≤ 0.003 mm at 2.5 x D	16 - 330	30000 - 50000	113 - 1490		Optional

*CAT 40 version is also available with 1/4" - 3/4" clamping diameters

TRIBOS®-Mini SVL coolant-proof polygonal extension

Optimized interfering contours and super-slim tool extension



- + Optimized interfering contour**
ideal for bores on low-lying areas, such as in fixture construction
- + Coolant-proof**
for use of tools with internal coolant supply with a pressure of up to 120 bar
- + Compatible with all conventional clamping systems**
no matter whether in hydraulic expansion, heat shrinking, power or polygonal toolholders

- + Clamping diameter from 0.5 mm to 6 mm**
- + For peripheral cooling or – new – as a coolant-proof version**
- + Completely rotationally symmetric**

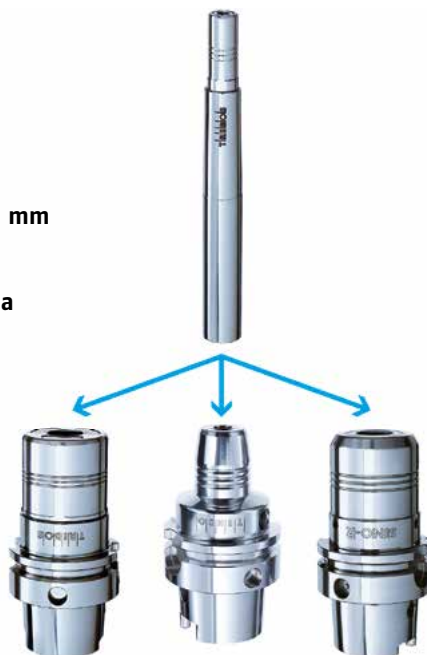

Run-out accuracy
≤ 0.003 mm
at 2.5 x D



Min. torque
1.5 .. 4.5 Nm



Max. speed for rotation
52000 RPM



Diameter
3 .. 6 mm
1/8"

schunk.com/tribos-svl



Technical data

Series	Clamping diameter [mm or inch]	Run-out accuracy	Min. torque [Nm]	Max. speed of rotation [RPM]
TRIBOS-Mini SVL-12 Ø3x100 KD	3 mm	≤ 0.003 mm at 2.5 x D	1.5	52000
TRIBOS-Mini SVL-12 Ø4x100 KD	4 mm	≤ 0.003 mm at 2.5 x D	2.5	52000
TRIBOS-Mini SVL-12 Ø5x100 KD	5 mm	≤ 0.003 mm at 2.5 x D	3.5	52000
TRIBOS-Mini SVL-12 Ø6x100 KD	6 mm	≤ 0.005 mm at 2.5 x D	4.5	52000
TRIBOS-Mini SVL-12 Ø3.175x100 KD	1/8"	≤ 0.003 mm at 2.5 x D	1.5	52000

easy Toolholder Configurator for toolholders

Fast, online and customized

NEW



- 1 **Machine interface**
flexible configuration for most common interfaces
- 2 **Option Zero**
for optimally adjustable run-out accuracy
- 3 **Clamping diameter**
individual selection of the clamping diameter for various clamping tasks
- 4 **Data carrier chip**
for direct clear assignment of tool and process data, available in 4 versions
- 5 **Peripheral cooling**
for optimized coolant emission
- 6 **Various lengths**
for interfering contour optimized processes

- + **Flexible configuration**
individual adaption to geometries, selection of the clamping diameter, machine interface, with or without data carrier chip and peripheral cooling
- + **3D data in real time**
view and download the configuration in different formats in real time
- + **Simple inquiry and order process 24/7**
receive inquiries and orders directly via the configurator. Price and delivery time are calculated directly



Available interfaces

HSK-A 40
HSK-A 50
HSK-A 63
HSK-A 100
HSK-C 40
HSK-C 50
HSK-C 63



Diameter
6 .. 32 mm
1/4 .. 1 1/4 "



Components lengths
HSK 40: L1 max. 120
HSK 50: L1 max. 150
HSK 63: L1 max. 200
HSK 100: L1 max. 250



Delivery time
Depending on configuration as of 30 days

schunk.com/easytoolholder

Technical data

Series	Clamping diameter [mm/inch]	Maximum projecting length (L1) [mm]	Long slim toolholder Ø [mm] *	Max. clamping depth [mm] *	Bore hole for data carriers	Option Zero (adjustment of the run-out accuracy) possible for	Option Cool-Flow
HSK-A 40	6 .. 20	120	up to 121	up to 115	in accordance with DIN 69873	Clamping Ø 8 - 20	configurable
HSK-A 50	6 .. 20	150	up to 119	up to 115	in accordance with DIN 69873	Clamping Ø 8 - 18	configurable
HSK-A 63	6 .. 32 / 1/4" .. 1 1/4"	200	up to 141	up to 160	in accordance with DIN 69873	Clamping Ø 8 - 32 and Ø 3/8" - 1 1/4"	configurable
HSK-A 100	6 .. 32 / 1 1/4"	250	up to 143	up to 160	in accordance with DIN 69873	Clamping Ø 8 - 32 and Ø 1 1/4"	configurable
HSK-C 40	6 .. 12	120	up to 119	up to 115	Optional	Clamping Ø 8 - 12	configurable
HSK-C 50	6 .. 20	150	up to 117	up to 115	Optional	Clamping Ø 8 - 20	configurable
HSK-C 63	6 .. 32	200	up to 117	up to 160	Optional	Clamping Ø 8 - 32	configurable

*depending on the selected clamping Ø

TANDEM® KSE3 IOL / KRE3 IOL

Electromechanical clamping force blocks





with integrated electronics and IO-Link interface

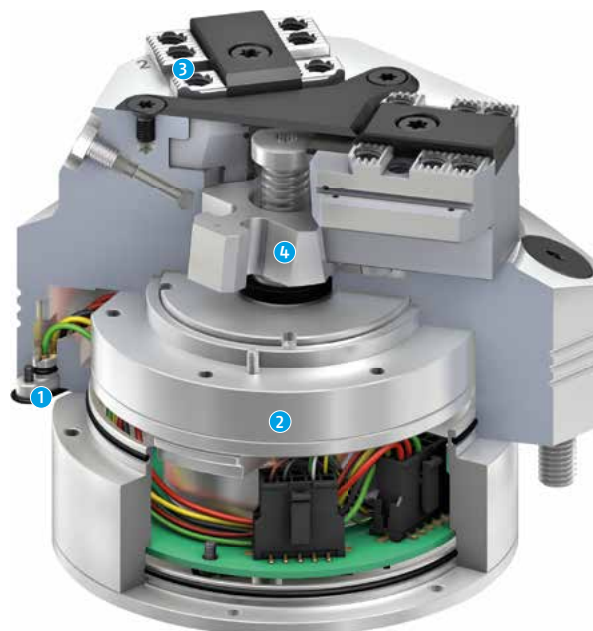

- +** Electric drive is integrated in the vise
signal processing occurs exclusively in the clamping device
- +** Pre-positioning of the jaws
for inserting an extremely wide range of workpieces
- +** Control via IO-Link
for easy integration in commonly used fieldbus systems

- 1 Bottom-sided connection**
with IO-Link control
- 2 Motor gearbox combination**
high reduction ratio for high clamping forces
- 3 Integrated electronics**
for transmitting power and control signals
- 4 Wedge-hook drive**
offers constantly high clamping forces in operation



- 
Sizes
100 .. 160 mm
- 
Power supply
24 V
- 
Repeat accuracy
< 0.01 mm
- 
Stroke per jaw
2 .. 8 mm
- 
Clamping force
8 .. 45 kN

Technical data

Series	Actuation method	Number of jaws	Sizes	Interface	Repeat accuracy [mm]
KSE3-IOL	Electromechanical	2	100, 140, 160	IO-Link	< 0.01
KRE3-IOL	Electromechanical	3	100, 160	IO-Link	< 0.01

Sensory clamping force blocks

with integrated sensor system for process monitoring



- +** **Monitoring of the jaw position**
for optimized automation of processes
- +** **Pressure sensor for actuating pressure**
for monitoring the open or clamped statuses
- +** **Control via IO-Link**
for easy integration into conventional fieldbus systems



Sizes
100 .. 315 mm



Clamping force
8 .. 95 kN



Stroke per jaw
2 .. 18 mm

- 1 Bottom-sided connection**
with IO-Link control
- 2 Integrated pressure sensor**
for measuring the opening and closing pressure
- 3 Integrated path measuring**
for detecting the piston or jaw stroke
- 4 Modular system TANDEM3**
identical interfering contour over machine table



Technical data

Series	Actuation	Sizes	Pressure sensor for actuating pressure	Monitoring of the jaw position	Interface
KSP-S3 IOL	Pneumatically	100, 140, 160, 200, 250, 315	yes	yes	IO-Link
KSH-S3 IOL	Hydraulically	100, 140, 160, 200, 250, 315	yes	yes	IO-Link

TANDEM® KSP3-BWA / KSH3-BWA

Clamping force blocks with jaw quick-change

For manual oder automated jaw change

NEW



+ **Jaw quick-change system**
for faster and easy jaw change
both manual and automated

+ **Workpiece system control
in the top jaw**
enables automated loading of
the clamping force block

+ **Patented monitoring of
the base jaw position via
dynamic pressure**
good to know, if the vise is
opened or closed

Sizes
100 .. 250 mm

**Number of
versions**
100

Clamping force
8 .. 75 kN

Stroke per jaw
2 .. 15 mm

[schunk.com/
tandem3-bwa](http://schunk.com/tandem3-bwa)

- 1 Teach marking**
for teaching the robot and positioning
of the jaw
- 2 Lateral sealing**
for protection of the interchange interface
- 3 Wide stop face**
for optimal power transmission to the jaw
- 4 Centering**
for the best repeat accuracy during jaw
change



Technical data

Series	Actuation	Sizes	Clamping force amplification for O.D. clamping, optional	Workpiece presence control/air purge	Inductive jaw monitoring (optional)
KSP3-BWA	Pneumatically	100, 140, 160, 250	yes	yes	yes
KSH3-BWA	Hydraulically	100, 140, 160, 250	yes	yes	yes
KRP3-BWA	Pneumatically	160, 250	yes	yes	no
KRH3-BWA	Hydraulically	160, 250	yes	yes	no

VERO-S NSE3 176

Quick-change pallet systems

For general milling applications and heavy-duty machining with an even higher rigidity and higher pull-down forces



- + SCHUNK modular system**
innumerable combinations of standard clamping devices suitable for different types of machines
- + Optional sensor monitoring**
for monitoring of the slider positions
- + Optional cone seal**
for protecting the interchange interface from coolant, dust, and chips

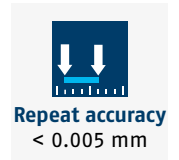
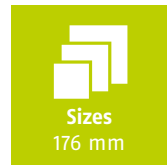

schunk.com/nse3

- 1 Patented dual stroke system**
between piston and clamping slide ensures maximum pull-down forces
- 2 Completely sealed system**
therefore absolutely maintenance-free
- 3 Large flat surface**
for best support and highest rigidity
- 4 Turbo function**
to increase the pull-down forces



Technical data

Size	Pull-down force [kN]	Pull-down force with turbo [kN]	Repeat accuracy [mm]
NSE3 176	9	40	< 0.005

VERO-S NSR3 138

Robot module

Very high transferable moments for reliable pallet handling or use as a quick-change unit for your robot



+ **Form-fit self-retained locking**
full pull-down force is maintained even in the event of a pressure drop

+ **Sensor monitoring (optional)**
monitoring option for the clamping slide position and pallet presence via AFS3-R IOL 138

+ **Maintenance-free**
robust and sealed housing made of stainless steel

Size
138 mm

Pull-down force
8 .. 28 kN

Repeat accuracy
< 0.02 mm

schunk.com/nsr3

- 1 High strength**
for reliable pallet handling even with high weights
- 2 Monitoring of the clamping slide position**
via AFS3-R possible
- 3 Patented dual stroke system**
between piston and clamping slide ensures for high pull-down forces
- 4 Air purge**
for quickly cleaning the module's clamping pin interface



Technical data

Size	Pull-down force [kN]	Pull-down force with turbo [kN]	Max. moment M_{xy} [Nm]	Max. moment M_z [Nm]	Repeat accuracy [mm]
NSR 138	8	28	1500	1600	< 0.02

VERO-S NSA3

Quick-change pallet systems

NEW GENERATION

Enhancing the tried-and-tested: Optimized for the modern requirements in pallet handling



- +** **Integrated monitoring and lifting function**
maximum process safety even with rough machining
- +** **Extremely flat design**
for maximum utilization of the machine room
- +** **The modules are corrosion-free and completely sealed**
long service life and maximum process safety



schunk.com/nsa3

- 1 Integrated cleaning function**
for cleaning the cone and contact surfaces of the clamping slide
- 2 Contact monitoring**
for monitoring the presence of the pallet and for cleaning the flat work surfaces
- 3 Completely sealed system**
therefore absolutely maintenance-free
- 4 Turbo function**
to increase the pull-down forces



Technical data

Size	Pull-down force [kN]	Pull-down force with turbo [kN]	Repeat accuracy [mm]
NSA3 120	3	10	< 0.005

Electromechanical quick-change pallet systems

with unbeatable power density, installation-compatible with standard modules

NEW



- +** **Electric drive integrated in the module**
signal processing takes place exclusively in the quick-change pallet module
- +** **Monitoring of the clamping slide position and pallet presence**
for reliable automation
- +** **Control via IO-Link**
for easy integration in commonly used fieldbus systems

- 1 IO-Link interface**
for simple integration in commonly used field bus systems
- 2 Bottom-sided connection**
for easy connection of the clamping module
- 3 Integrated electronics**
signal processing occurs in the clamping device
- 4 Drive via piezoelectric actuator**
ensures high pull-down forces in a small installation space



- Size**
138 mm
- Pull-down force**
8 .. 20 kN
- Holding force clamping pin**
35 .. 75 kN
- Supply voltage**
24 V
- Repeat accuracy**
< 0.005 mm

Technical data

Sizes	Pull-down force [kN]	Supply voltage [V]	Interface	Repeat accuracy [mm]	Suitable for clamping pins
NSE3-PH 138 IOL	8 .. 20	24	IO-Link (class B)	< 0.005	Size 40
NSE3-PH 138-V1 IOL	8 .. 20	24	IO-Link (class B)	< 0.005	Size 40

VERO-S Quick-change pallet systems

Sensory clamping modules



Integrated sensor system for detecting pallet presence and clamping position without additional interfering contour



- +** Sensor system integrated in the quick-change pallet system
no additional interfering contour
- +** For monitoring the clamping slide position and pallet presence
for reliable automation
- +** Signal transmission via IO-Link
for easy integration in commonly used fieldbus systems



Sizes
90 .. 138 mm



Pull-down force
4 .. 28 kN



Supply voltage
24 V



Repeat accuracy
< 0.005 mm

- 1 Integrated electronics and bottom-sided connection**
with IO-Link signal transmission
- 2 Monitoring pallet presence**
for detecting pallet presence
- 3 Monitoring of the clamping slide position**
for detecting the "module clamped" or "module opened" statuses
- 4 Pressure sensor**
to detect whether the turbo function is activated



Technical data

Sizes	Actuation	Pull-down force [kN]	Pull-down force with turbo [kN]	Unlocking pressure [bar]	Integrated monitoring
NSE-E mini 90-25 IOL	Electromechanical	4			Clamping slide position, pallet presence
NSE-S3 138 IOL	Pneumatic	8	28	6	Turbo function, clamping slide position, pallet presence
NSE-S mini 90-25-IOL	Pneumatic	1.5	6	6	Turbo function, clamping slide position, pallet presence

Chuck jaw quickfinder

Find the right jaws with just a few clicks

NEW

Expansion of the chuck jaw quickfinder to include stationary clamping devices from the KONTEC and TANDEM product ranges



- + Faster to the appropriate chuck jaws**
through predefined selection menus and intelligent filters
- + Simple differentiation between system and top jaws**
through separate presentation of the two types of jaws in existing control concepts
- + Direct shop connection**
desired products can be added to the shopping cart immediately

Total number of jaws
1350

schunk.com/backen-quickfinder



- + The right chuck jaw for any requirement**
both for lathe chucks and for clamping force blocks or manual clamping systems
- + Large selection of products**
due to the unique standard chuck jaw program
- + Uncluttered list of results**
with additional product information
- + Find suitable jaw pairs**
easily possible by faceting the jaw interface



Scope of chuck jaw quickfinder

Quickfinder	Number of clamping devices	Number of chuck jaws
Chuck jaw quickfinder stationary	600	350
Chuck jaw quickfinder lathe chucks	900	1000

KONTEC Configurator Fast. Online. Customized.

Combine the complete clamping solution as desired

NEW

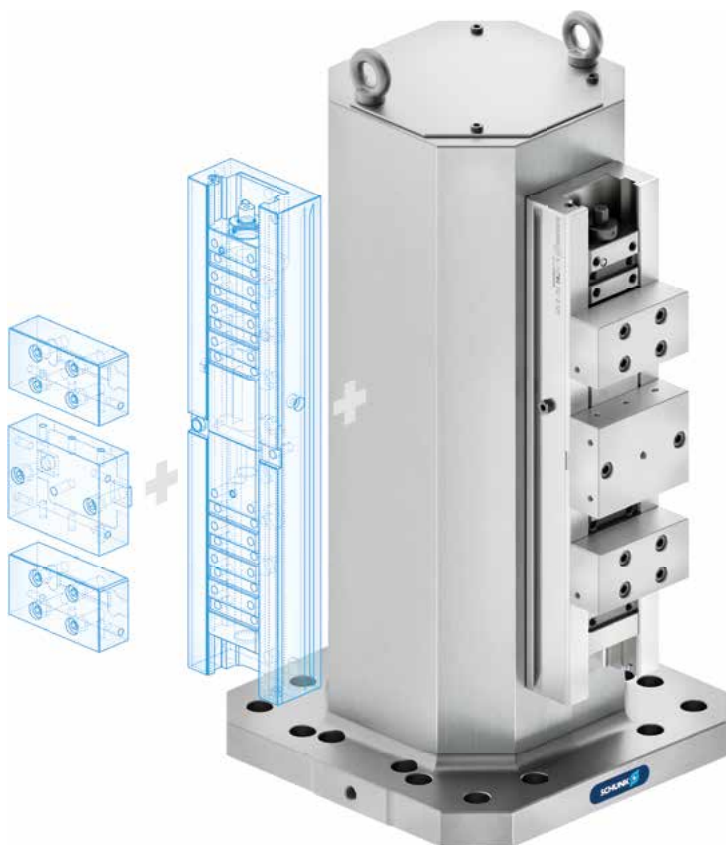

- + Limitless possibilities**
due to combination of all KONTEC clamping systems and jaws
- + 3D data in real time**
visualize desired product and download as .step data and export parts lists
- + Preconfigured solutions to get you started**
extensive collection of customer solutions to find inspiration for your production



Configure it
online now:

schunk.com/kontec-konfigurator

Pneumatic gripping

Pneumatic grippers from SCHUNK have stood for high quality and reliability for many years. The focus is always on your workpiece: from small to large, from round to square, for every batch size and every application environment.

The power of our pneumatic grippers

- + **Proven technology:** Decades of development and optimization characterize the technology of our pneumatic grippers.
- + **Longevity:** The robust design ensures high resistance and a long service life.
- + **Versatility:** Suitable for a wide range of tasks, industries and operating environments.
- + **High quality:** The high performance of the pneumatic grippers corresponds to the usual SCHUNK quality.



BSWS-R

The automatic jaw quick-change system BSWS-R enables fast and automatic exchange of the top jaws on the gripper.



PPD

The new PPD positioning device enables free positioning and adjustment of the gripping force and gripper jaw speed of the pneumatic gripper.

PGL-plus-P

The PGL-plus-P universal gripper with long jaw stroke offers highlights such as secure certified gripping force maintenance and integrated sensor technology.

PGL-plus-P Universal gripper

The world's first pneumatic gripper with safe and certified gripping force maintenance



1 Base jaw

with standardized screw connection diagram for the adaption of the workpiece-specific gripper fingers. The centering sleeves are attached so that they cannot be lost when exchanging fingers.

2 Multi-tooth guidance

maximum service life due to lubricant pockets in the robust multi-tooth guidance, and absorption of high forces and torques by means of the large guidance support.

3 Pneumatical drive pistons and kinematics

maximum power generation through two oval pneumatic pistons. The rack-and-pinion kinematics ensure synchronization of the base jaws and centric clamping.

4 Dust cover

The entire circumference of the gripper is encapsulated with metal and additionally sealed with a lip seal at the base jaws so that it is suitable for universal use, even in dirty environments.

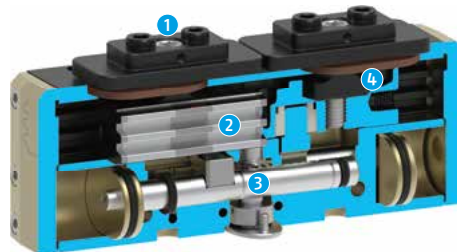

+ Secure, certified gripping force maintenance GripGuard

holds the gripped workpiece safely and also ensures a permanent gripping force of min. 80% in case of pressure drop. It also ensures that no dangerous, spontaneous jaw movements can occur in the event of a pressure drop

+ Integrated sensor system

for precise and process-reliable monitoring of the complete gripper stroke via IO-Link

+ Long jaw stroke

enables flexible handling of a wide range of parts



Sizes
10 .. 25



Weight
0.46 .. 7.9 kg



Gripping force
145 .. 1900 N



Stroke per jaw
10 .. 25 mm



Workpiece weight
0.72 .. 7 kg

[schunk.com/
pgl-plus-p](http://schunk.com/pgl-plus-p)



Technical data

Sizes	Stroke per jaw [mm]	Closing force [N]	Opening force [N]	Recommended workpiece weight [kg]	Weight [kg]	Max. permissible finger length [mm]
10	10	145 .. 295	145 .. 295	0.72 .. 1.1	0.46 .. 0.75	100
13	13	230 .. 475	230 .. 480	1.2 .. 1.8	0.8 .. 1.3	130
16	16	365 .. 750	365 .. 740	1.8 .. 2.8	1.4 .. 2.2	160
20	20	585 .. 1170	585 .. 1170	2.9 .. 4.4	2.7 .. 4.2	210
25	25	930 .. 1900	930 .. 1900	7	5.1 .. 7.9	260

PPD

Pneumatic positioning device

Positioning device for flexible control of pneumatic grippers



- + **Free positioning of a pneumatic gripper**
 enables cycle time optimization or collision avoidance by pre-positioning the gripper finger
- + **Gripping force adjustability by adjusting the output pressure**
 for gripping workpieces of different sensitivity
- + **Adjustability of the gripper jaw speed**
 for workpiece-friendly gripping due to the reduction of the gripping impulse

schunk.com/ppd



- 1 **Pneumatic positioning device**
PPD
- 2 **Pneumatic gripper**
PGL-plus-P-IOL
- 3 **Position sensor**

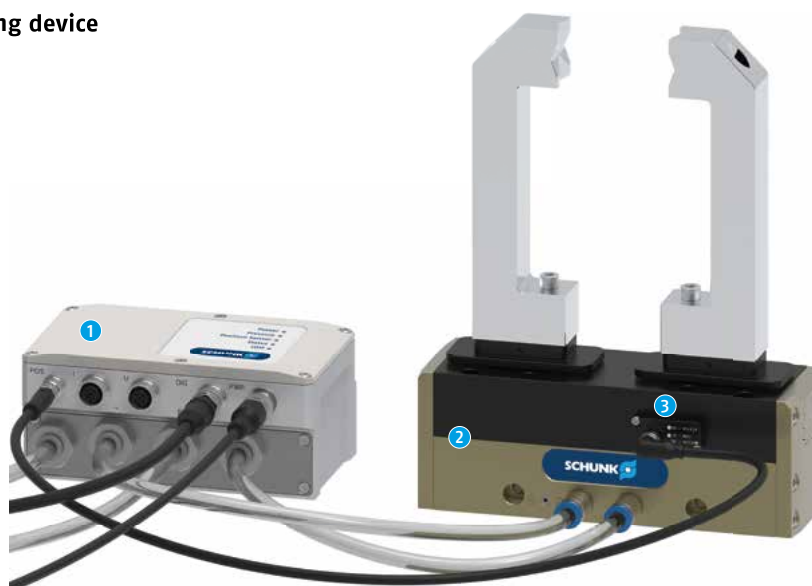

The pneumatic positioning device is an accessory for pneumatic grippers. Together with a position sensor, any positions of the gripper fingers can be approached in addition to the end positions (gripper open and gripper closed). Four integrated high-speed 2/2 valves together with the integrated electronics ensure a closed control loop. Communication takes place via IO-Link.

BSWS-R

Automatic jaw quick-change system

Quick and easy changeover, operated solely by the movement of the robot

NEW



- + Maximum flexibility**
With the BSWS family, one single gripper can be used universally in various applications.
- + Time savings when converting applications**
Different workpieces can be handled by exchanging the gripper fingers.
- + PGN-plus-P fingerprint**
Enables universal use and retrofitting in a wide range of gripper series.

- 1 Base of the jaw quick-change BSWS-BR
- 2 Fastening of the workpiece-specific gripper finger
- 3 Adapter pin BSWS-AR for fastening to the gripper base jaw
- 4 Spring preloaded locking pin



schunk.com/bsws-r

Technical data

Finger screw connection diagram	Jaw quick change Adapter pin	Jaw quick-change Base	Storage system	Attachment kit inductive monitoring
BSWS-BR 50	0.03	BSWS-AR 50	2	BSWS-SR 50
BSWS-BR 64	0.05	BSWS-AR 64	2	BSWS-SR 64
BSWS-BR 80	0.07	BSWS-AR 80	2	BSWS-SR 80
BSWS-BR 100	0.15	BSWS-AR 100	2	BSWS-SR 100
BSWS-BR 125	0.22	BSWS-AR 125	2	BSWS-SR 125
BSWS-BR 160	0.46	BSWS-AR 160	2	BSWS-SR 160
BSWS-BR 200	0.97	BSWS-AR 200	2	BSWS-SR 200
BSWS-BR 240	1.49	BSWS-AR 240	2	BSWS-SR 240
BSWS-BR 300	1.98	BSWS-AR 300	2	BSWS-SR 300

Mechatronic gripping

Our range of electric parallel grippers currently comprises four product series that are optimally adapted for use in various application areas in terms of gripping force and stroke. This allows you to find the right gripping solution for your application quickly.

For the requirements of modern process flows, mechatronic grippers offer many advantages

- + **Flexible in use:** Variety of parts, adjustment options (positioning, stroke, force, gripping modes), future-proof thanks to new software functions that can be added at a later date.
- + **Connectivity:** Added value through standardized interfaces (flexible and simple networking with all relevant robot and controller manufacturers).
- + **Process feedback:** For greater process stability and reliability due to integrated monitoring and analysis options.

ELG

Customized configurable long stroke gripper

The electric gripper for large workpieces with configurable stroke accurate to the millimeter

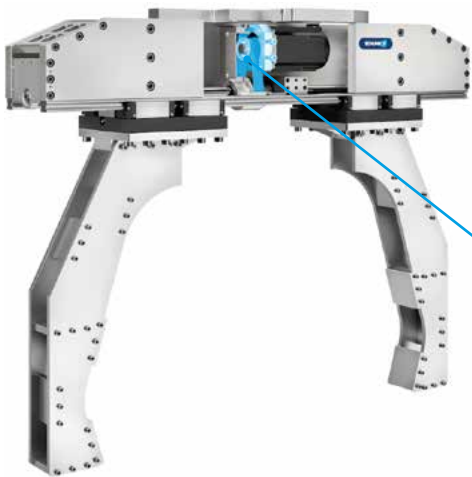

With motor-specific attachment kit:

Bosch Rexroth
Siemens
Allen-Bradley
FANUC
KUKA
SEW-EURODRIVE

Mitsubishi Motors

NEW

With motor:

Bosch Rexroth
Siemens

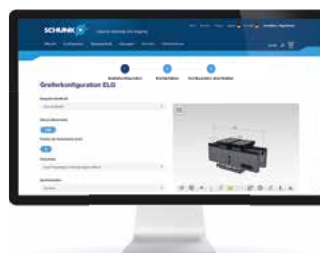

Configure it
online now:

schunk.com/elg

EGU and EGK

Universal grippers and grippers for small components

For flexible workpiece handling

+ Minimal integration effort

through a diverse range of communication interfaces, as well as PLC function blocks and robot plug-ins compatible with leading manufacturers in the market

+ Versatile and productive

due to the large and freely programmable jaw stroke with continuous gripping force adjustment for flexible workpiece handling

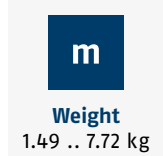

EGU universal gripper



StrongGrip
up to 200%

- + **Robust and reliable**
with sealed design and proven sliding guide particularly suitable for harsh ambient conditions of machine loading

schunk.com/egu



EGK gripper for small components



- + **Reliable and sensitive**
particularly suitable for the requirements of laboratory automation and electronics production thanks to the sealed design and smooth-running profiled rail guide

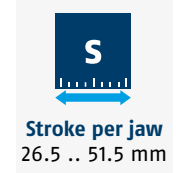

schunk.com/egk



Technical data

Series	Sizes	Stroke per jaw	Min. gripping force	Max. gripping force	Max. permissible finger length	Weight
		[mm]	[N]	[N]	[mm]	
EGU	50	51	150	600	80	1.49
EGU	60	60	325	1300	125	2.9
EGU	70	70	650	1950	160	4.52
EGU	80	80	1000	4000	200	7.72
EGK	25	26.5	20	50	70	0.62
EGK	40	41.5	55	150	100	1.02
EGK	50	51.5	150	300	130	1.63

E-Mobility

SCHUNK is your reliable partner for production's transition to E-Mobility. We are an automation specialist and competence leader for toolholding and workholding, gripping technology and automation technology and supply you with everything from axis systems to robot accessories from a single source. Thanks to the clever combination of our standard products, we always find an individually suitable solution for you. You will benefit from our many years of engineering know-how in the industry. SCHUNK products are already known by all well-known automotive manufacturers and their suppliers. This accelerates integration into new process chains enormously, and keeps you in the fast lane from the very beginning when switching to E-Mobility.

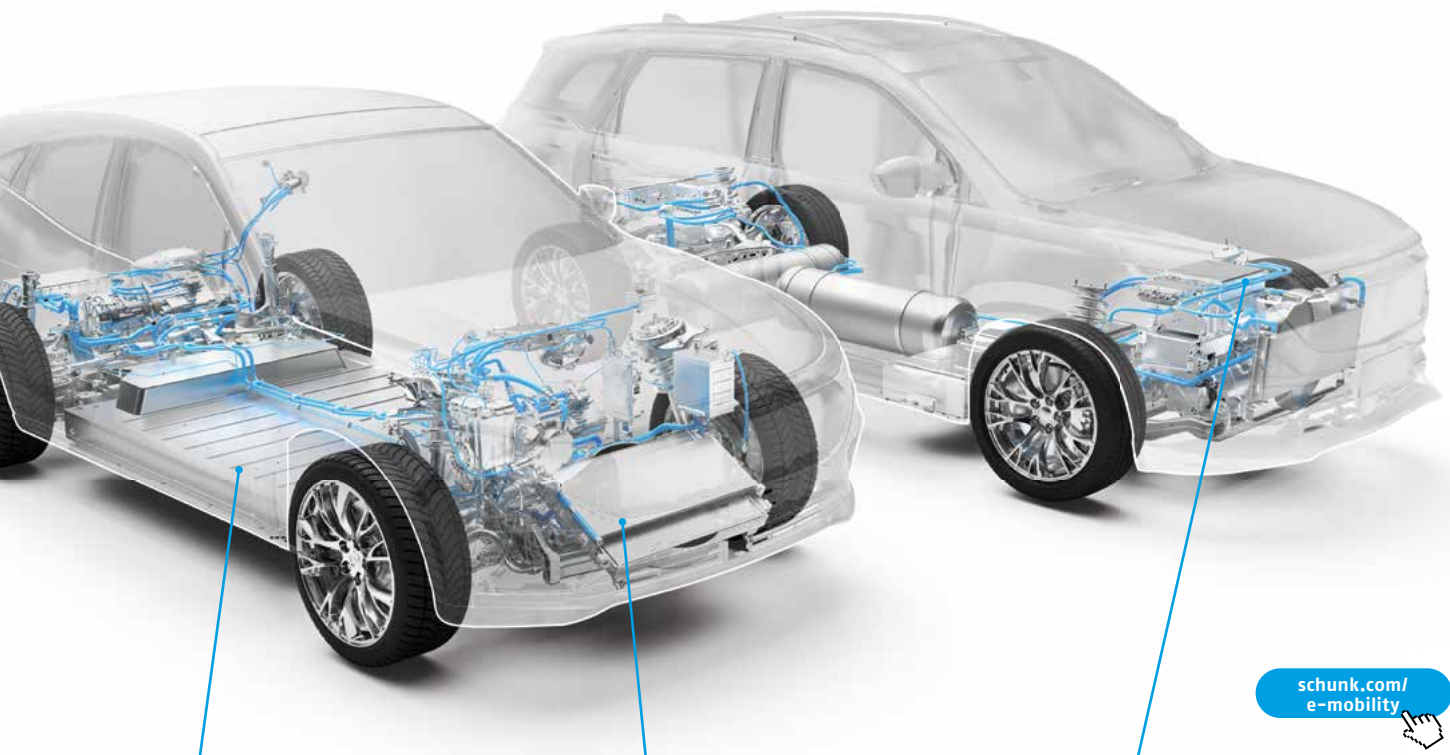

schunk.com/e-mobility

Battery systems

The entire automation spectrum is utilized in the manufacture of battery systems. This applies to high-speed handling of individual cells to handling the highest dimensions of battery modules and packs.



E-drive

Electric motors place the highest demands on automation. Whether it concerns the specific setting of the hairpins, handling of the sheet packages, or assembly of the components to the finished e-axis: SCHUNK supports you.



Fuel cells

Fuel cells have a high energy density and a short refueling time. That is why they are increasingly being used in mobile and stationary applications. SCHUNK offers extensive solutions for handling fuel cells and their components.



RCG

Round cell gripper

Flexible gripping unit with minimal interfering contour for maximum packing density

NEW

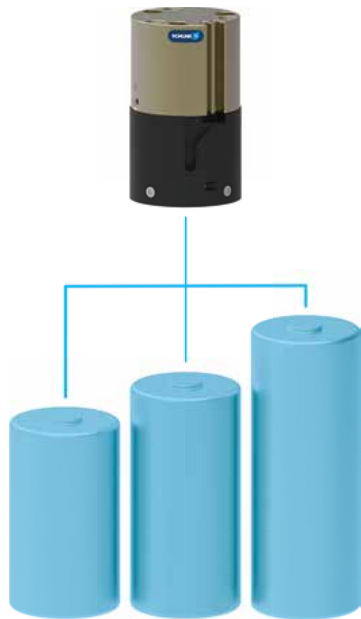

The RCG gripper can securely handle all common formats of \varnothing 46 mm round cells.

- + Compact outside dimensions**
the individual gripper enables maximum packing density of battery cells
- + Maximum process reliability**
through sensory workpiece and status detection
- + Avoidance of workpiece loss**
thanks to the integrated gripping force maintenance, even in the event of energy loss

Number of sizes
1

F
Magnetic holding force
 ≥ 70 N

m
Weight
0.25 kg

schunk.com/rcg

- 1 Pneumatic drive**
with C-slot for piston stroke monitoring
- 2 Electrically decoupled contact surface**
to protect the charged battery cell that is in flat contact
- 3 Centerings**
The centerings in versions -2 and -4 are used to compensate for placement tolerances when picking up the battery cells



From the round cell to the battery pack

SCHUNK solutions seamlessly handle the transition from individual battery cells to the finished battery packs from a single source. The combination of the round cell gripper RCG and further SCHUNK components such as sensors, compensation units, cell spacing units and linear direct axes, enables precise and dynamic processes. The RCG is customized for your application and is individually scalable.



CMS

Manual change system

User-friendly manual change system with extensive complementary portfolio

The manual change system CMS impresses with its user-friendliness, diversity in modules, and extensive range of accessories. It can be used on robots as well as in stationary applications, wherever tool changes are important.

Your added value:

- + **ISO flange pattern**
for simple assembly on most types of robots without additional adapter plates
- + **Locking and tool presence monitoring as standard**
for process-reliable monitoring of the locking status, optionally with sensors
- + **Integrated air feed-through via sealing pins with cylinder seals**
for minimum effort when locking
- + **Locking lever**
Proven (push lever) technology for manual actuation without additional tools
- + **High module diversity**
for diverse media transmission options
- + **Available as basic variant**
without integrated air feed-throughs for easy applications



schunk.com/cms



NEW

Precisely interchangeable

For existing customers, SCHUNK offers the CMS manual change systems as a 1:1 replacement for the predecessor model. The same overall height as well as identical screw-on patterns on the robot and tool side enable existing systems to be converted quickly and easily.

Even better now

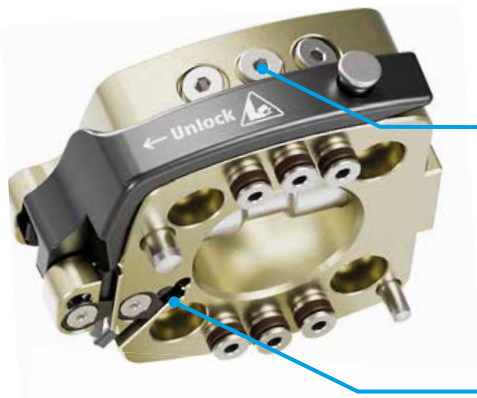

All air feed-throughs can be used radially

Instead of before: only 50% radially useable over head

Locking and tool presence monitoring can be integrated into any size

Instead of before: integration possible from size 100 onwards



Direct screw connection to electric, pneumatic and fluid modules

Instead of before: adapter plate required

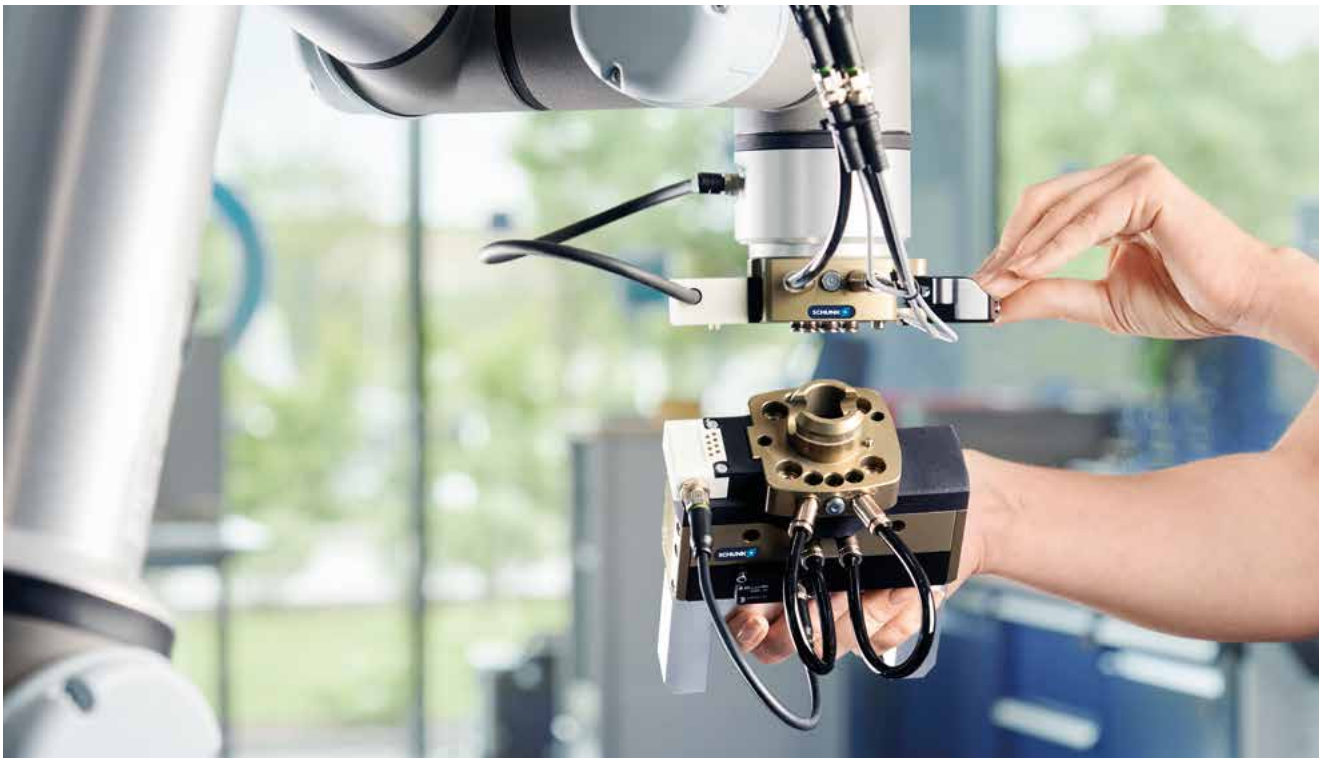

Linear modules & axis systems

For positioning and movement tasks, or for any type of automation of handling processes – SCHUNK offers the diversity of linear technology from a single source. Different types of standard modules can be combined into a complete system. There are many variants to choose from for both the drive and the guide concept.

The advantages of SCHUNK linear modules and axis systems

- + **Flexible and extensive combinations**
with different drive concepts
- + **Over 25 years of experience in the field of linear technology**
large axis system portfolio with more than 450 standard components
pneumatic and electric
- + **Comprehensive consulting service**
from the right axis technology to design
- + **Pre-assembled complete solutions for minimal assembly effort**
and immediate commissioning including commissioning support

SLD Linear direct axis

The SLD series is a new generation of SCHUNK linear direct axes. The dynamic, heavy-duty axes with electric linear direct drive ensure short cycle times and higher productivity in high-speed assembly and handling processes. Due to the high drive forces up to a maximum of 2.4 kN and the load rating of up to 106 kN as well as the long service life, the axis is ideally suited for any industry – even for demanding cell production in the dry room.

High basic load ratings

for high bearing load capacity and service life

No mechanical play between the drive components

for fast response mode and high positioning accuracy

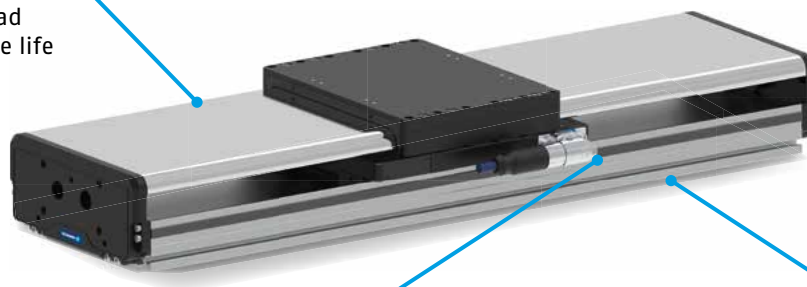

Almost no wear parts

for long service life and reliability of the system

Linear module configurator

Crafting individual linear modules digitally

NEW

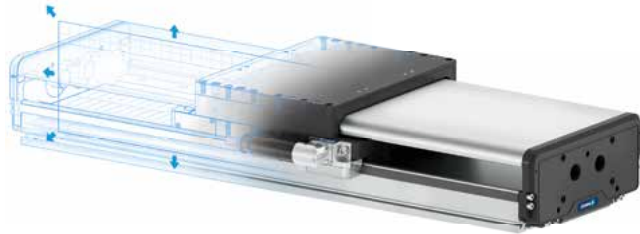

- + Fast**
CAD data and technical data sheets are immediately available
- + Simple**
because no developer knowledge is required
- + Direct contact**
seamless contact directly from the tool



Configurable series:

Alpha
Beta
Delta
Gamma
LDL
LDN
LDM
LDT
LDK
SLD
ELB

Receive your individual linear module in four steps:

- 1 Linear module selection
- 2 Linear module configuration
- 3 Enter contact details
- 4 Finalize configuration



Configure it online now:

[schunk.com/
konfigurator-linearmodule](https://schunk.com/konfigurator-linearmodule)

The complete solution from a single source

Start your next automation project with our individually configurable linear modules. Once configuration is complete, they can be seamlessly integrated into a SCHUNK axis system. The SCHUNK online tool enables application-specific configuration of all accessories and provides technical data sheets and CAD data for seamless integration into your system planning. For positioning and motion tasks or for any other kind of automation for handling processes. SCHUNK axis systems offer the diversity of linear technology from a single source.

Depaneling technology

SCHUNK offers solutions for the entire depaneling spectrum – from product selection to workpiece carrier solutions and optimization of the milling parameters to commissioning. Our product range focuses on modern processes in electronic module production. Our systems and devices meet the most demanding requirements resulting from increasing miniaturization, the use of highly sensitive components, and the rising quality demands for PCBs.

Benefit from innovative functions:

- + Dust Reduce Booster**
With the patented "Dust Reduce Booster" technology in the SAR and ILR depaneling machines, we reduce fine dust deposits on the PCB by an additional 70% compared to conventional dust extraction systems – or even eliminate them completely.
- + New HMI operating software**
The user interface for optimized operating processes also ensures an increase in energy efficiency and system security. Now with an extended range of functions in user management, energy measurement and data backup.



[schunk.com/
nutzentrenner](https://schunk.com/nutzentrenner)



Inline depaneling machine ILR-Performance

NEW



- + Economical and efficient**
due to low investment and high productivity
- + Versatile and productive**
due to the modular design and standard accessories
- + Robust, reliable and precise**
in large-scale production due to a high milling accuracy and availability



Dust Reduce
Booster

- 
Speed of axes
up to
2000 mm/s
- 
Milling area
460 x 364 mm
- 
Repeat and
positioning
accuracy
±0.02 mm
- 
Milling
accuracy
±0.1 mm

Stand-alone laser machine SAL-1300

NEW



- + Optimized process times**
up to 80% faster laser cutting processes
than conventional applications
- + Precise cutting results**
as the optimal alignment of the laser to
the workpiece is ensured
- + High level of flexibility**
thanks to the modular design and the
option of combining laser processing and
milling technology

- 
Speed of axes
up to
1000 mm/s
- 
Milling area
430 x 350 mm
- 
Repeat and
positioning
accuracy
±0.02 mm
- 
Milling
accuracy
±0.2 mm

Technical data

Length/width/ height [mm]	Operator height [mm]	X-, Y-linear motor actuators [mm/s]	Z-axis linear motor axis [mm/s]	Repeat accuracy/ positioning accuracy [mm]	Milling accuracy without vision system [mm]	Milling accuracy with vision system [mm]	Max. panel size X- and Y-direction [mm]
1900/2115/2285	950	2000	1000	±0.02/±0.02	±0.13	±0.1	460 x 364
1320/2500/2280	894	1000	1000	±0.02/±0.02	±0.2	±0.15	430 x 350



SCHUNK SE & Co. KG
Spanntechnik
Greiftechnik
Automatisierungstechnik

Bahnhofstr. 106 - 134
D-74348 Lauffen/Neckar
Tel. +49-7133-103-0
info@de.schunk.com
schunk.com

Follow us



We print sustainably



1583319-8.8M-04/2024

