

TORNOS

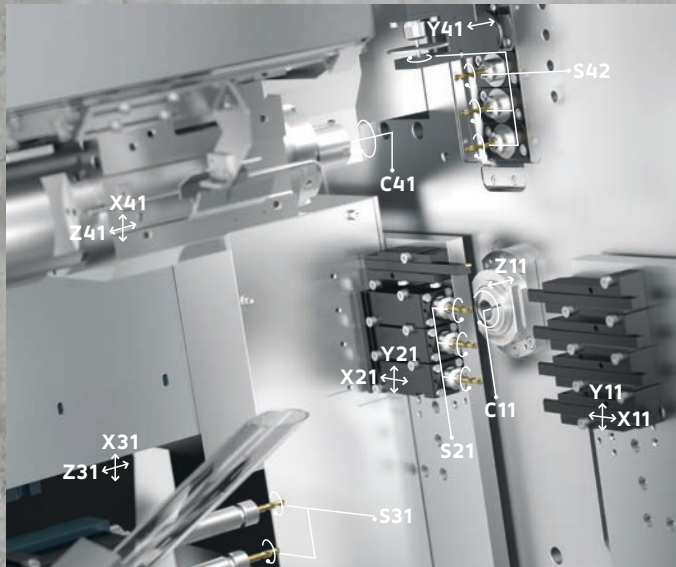

*Swiss-type
& multispindle*

PRODUCT RANGE



EvoDECO 10

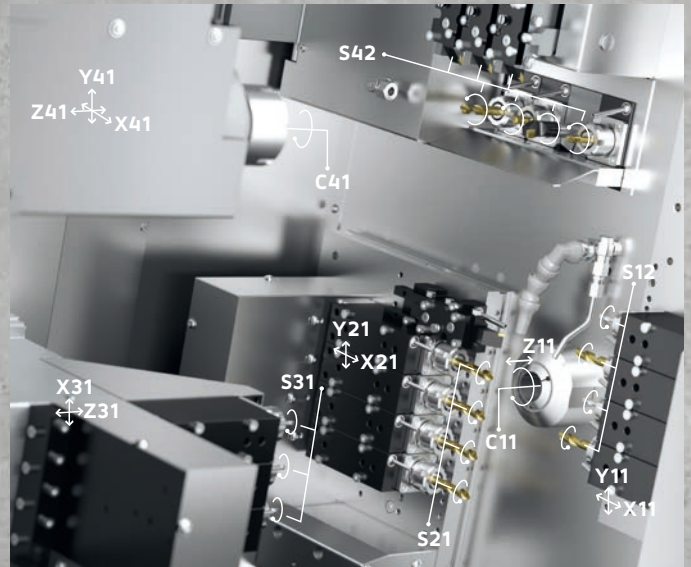

EvoDECO 20 & EvoDECO 32

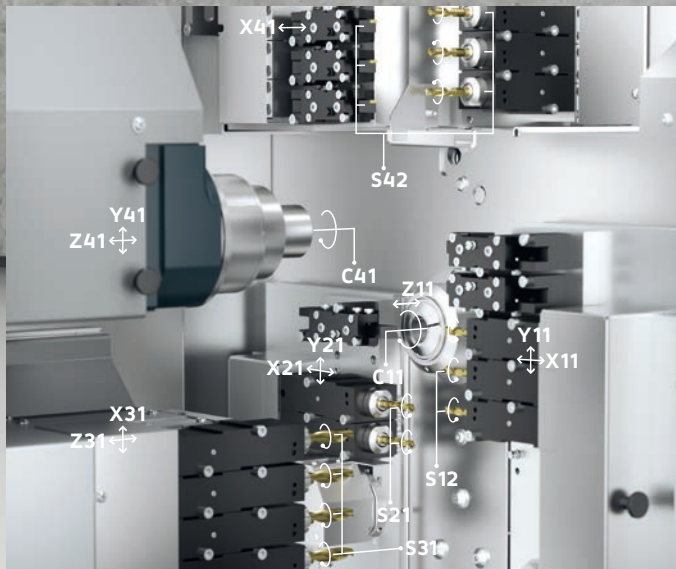

EvoDECO 16

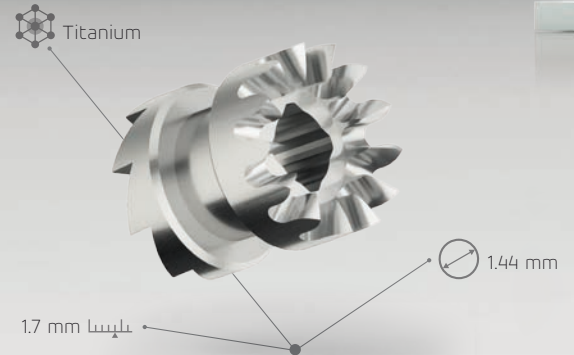

Micromechanics

Your benefits

- Identical spindle and counter spindle, with synchronous motors
- Infinite possibilities to machine advanced parts
- Highest productivity available on the market
- Completely modular machining area
- Modular/pre-adjustable tool systems and devices

Kinematics

- EvoDECO 10, 2 versions with 10 or 8 axes + 2 C axes
- EvoDECO 16, EvoDECO 20 and EvoDECO 32, 10 linear axes + 2 C axes
- 4 independent tool systems (10 linear axes) or 3 independent tool systems (8 linear axes)
- Gear hobbing
- Polygon milling/thread whirling
- Internal and external thread whirling
- Torx milling
- Deep drilling
- Angled milling for main operations and counter operations
- B-axis in counter operation (EvoDECO 16)

EvoDECO range

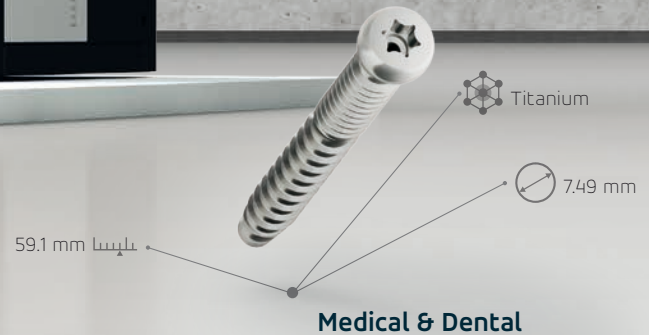
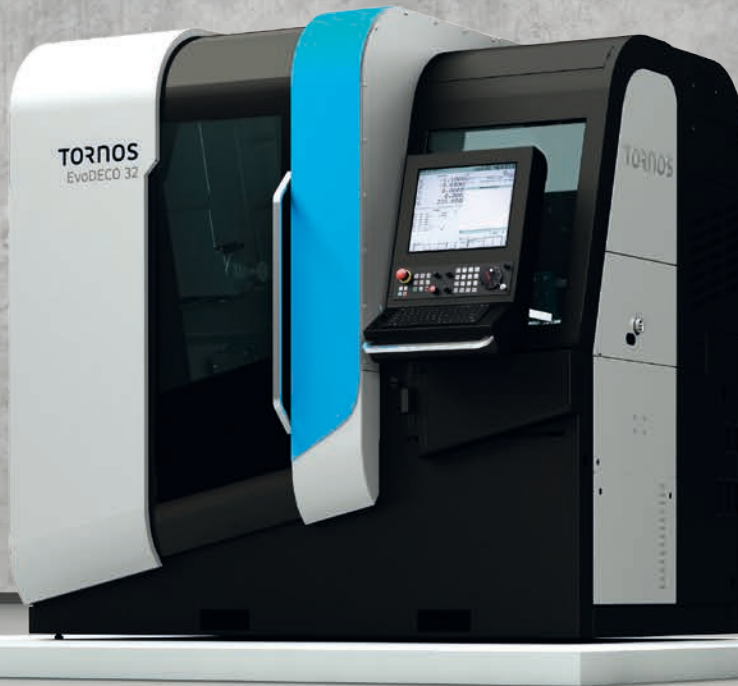

The most productive and powerful machines on the market

As the pinnacle of the Tornos range, the 10-, 16- mm, 20- and 32-mm diameter EvoDECO machines are designed for the most demanding machining operations and users. Unparalleled flexibility, efficient production the most complex workpieces and rapid setup changes are EvoDECO hallmarks.

in Brief	EvoDECO 10	EvoDECO 16	EvoDECO 20	EvoDECO 32
Max. bar capacity	10 mm	16 mm	25,4 mm	32 mm
Spindle rotation speed	14.000 rpm	12.000 rpm	10.000 rpm	8.000 rpm
Standard workpiece length with rotating guide bush	100 mm	180 mm	220 mm	260 mm
Total number of tool positions	22	27	27	27
Positions for rotating tools	10	15	17	17

CT 20

Powerful, robust bar turning machine

The CT 20 is designed to fulfil manufacturers' needs when creating simple to moderately complex components. The easy-to-use, productive and powerful CT 20 is the best choice for a quick return on investment.



in Brief	CT 20
Max. bar capacity	20 mm
Spindle rotation speed	10.000 rpm
Standard workpiece length with rotating guide bush	210 mm
Total number of tool positions	27
Positions for rotating tools	11

Your benefits

- Powerful spindles and drives
- Great value for price resulting in early return on investment
- Compact machine/floor space
- Ideal replacement of cam-type lathes
- Proven kinematics, excellent chip flow

Kinematics

- 5 linear axes + 2 C axes
- 2 independent tool systems

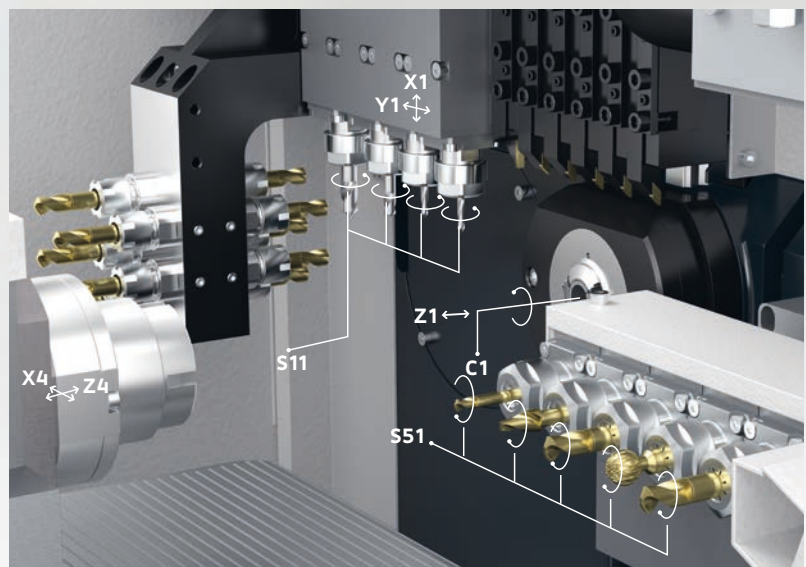

CT 20

Swiss DT range

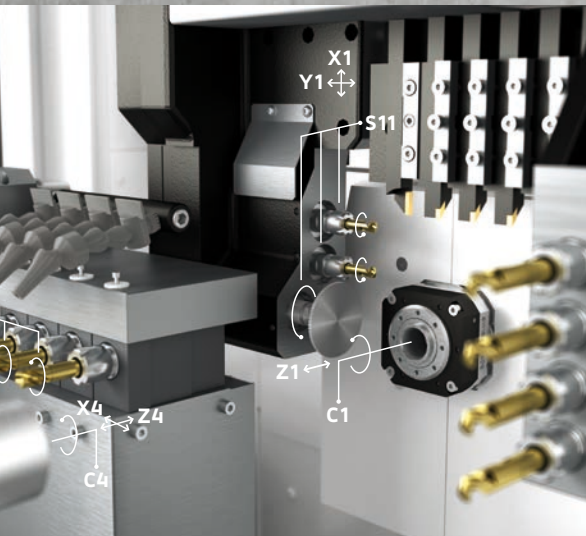

Swiss DT 13

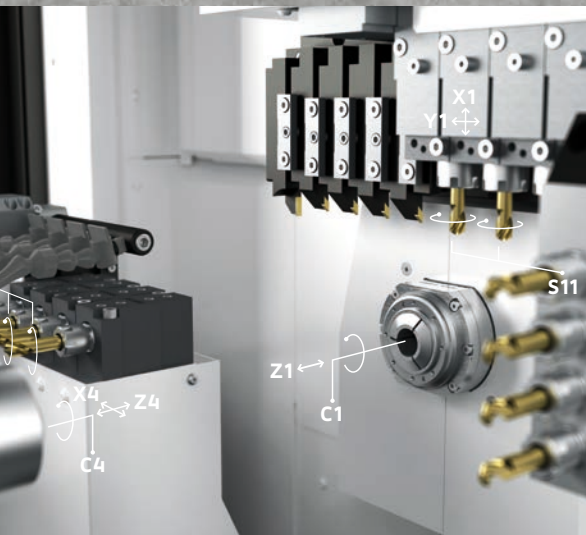

Swiss DT 26

The gateway to the Tornos world
 Tornos' simple, easy-to-use Swiss DT Swiss-type lathes meet the requirements of typical long and short turned parts. Designed to machine bars up to 13 and 25.4 mm in diameter, the range enables measurable production improvements. Advanced technical features and efficient five-axis kinematics make it your ideal turning and milling solution.



in Brief

	Swiss DT 13	Swiss DT 26
Max. bar capacity	13 mm	25.4 mm
Spindle rotation speed	15.000 rpm	10.000 rpm
Standard workpiece length with rotating guide bush	180 mm	195 mm
Total number of tool positions	21	22
Positions for rotating tools	7	8



Your benefits

- Liquid-cooled built-in motorized guide bush with synchronous motor
- Work with or without a guide bush
- Tools system and modular equipments
- Identical spindle and counter spindle, with asynchronous motors
- Excellent chips evacuation

Kinematics

- 5 linear axes + 2 C axes
- 2 independent tool systems
- Polygon milling
- Thread whirling
- Angled milling
- Gear hobbing

Swiss GT range

Versatility

Competitively priced automatic turning machines with a full standard equipment package. Simple and ergonomic, the Swiss GT range offers easy access to all tool positions. Its automatic lubrication unit, swarf tray and removable oil pan make it easy to maintain. Available in 32-, 25.4- and 13-mm diameters, the line will drive your successful production of long and short turned parts.



in Brief

	Swiss GT 13	Swiss GT 26	Swiss GT 32
Max. bar capacity	13 mm	25.4 mm	32 mm
Spindle rotation speed	15.000 rpm	10.000 rpm	8.000 rpm
Standard workpiece length with rotating guide bush	180 mm	220 mm	200 mm
Total number of tool positions	30	40	40
Positions for rotating tools	12	14	14

Your benefits

- Liquid-cooled built-in motorized guide bush with synchronous motor
- Work with or without a guide bush
- Tools system and modular equipments for highly complex parts machining
- Identical spindle and counter spindle, with asynchronous motors
- Modular B axis in main operation and counter operation
- Simultaneous five-axis machining (option)

Kinematics

- 6 linear axes + 2 C axes
- 2 independent tool systems
- Polygon milling
- Thread whirling
- Angled milling
- Gear hobbing

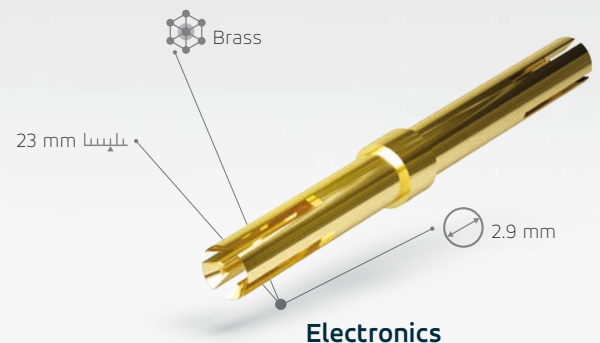



Swiss GT 26B	Swiss GT 32B
25.4 mm	32 mm
10.000 rpm	8.000 rpm
220 mm	200 mm
36	36
16	16

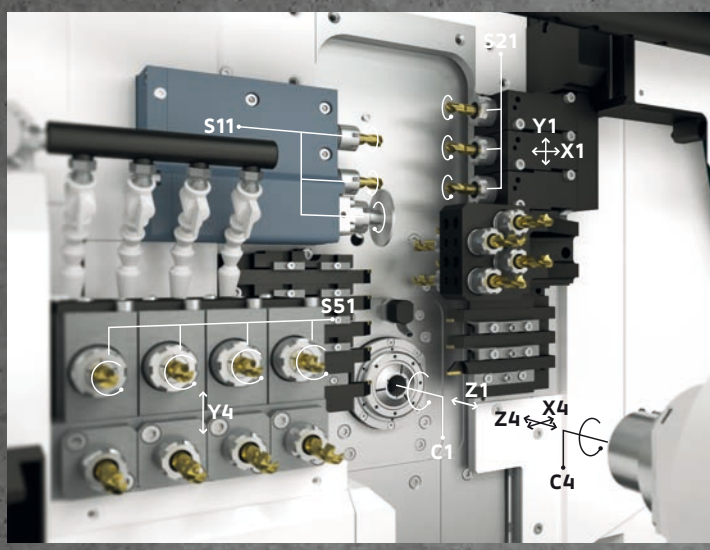

Swiss GT 13

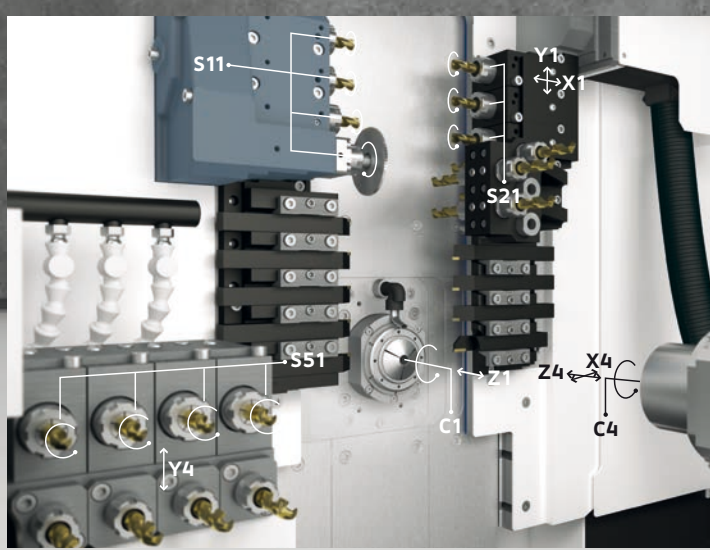

Swiss GT 26 & Swiss GT 32

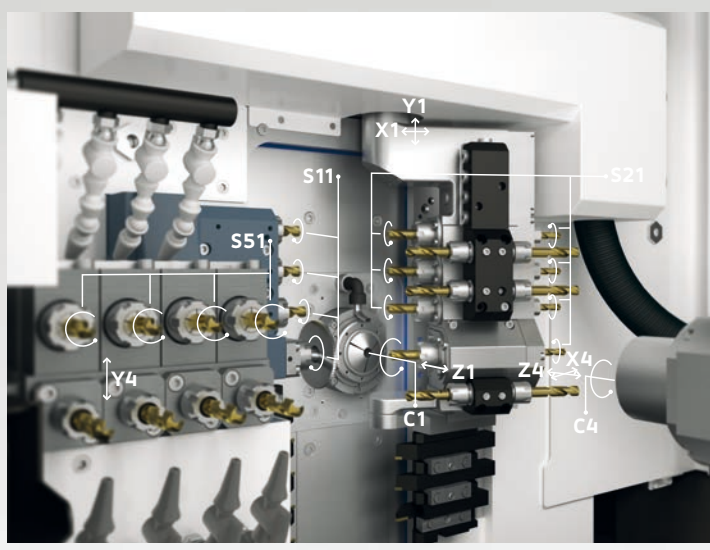

Swiss GT 26B & Swiss GT 32B



SwissDECO range

Taking performance to new heights

SwissDECO provides a complete product range, with at least 3 machines available in two diameters – 25.4 mm and 36 mm.

All equipped with 3 independent tool systems, SwissDECO machines are designed to provide exceptional operating flexibility, while remaining extraordinarily user-friendly. The SwissDECO range concentrates more than 100 years of experience in a single machine. More than simply a range of machines, it is a vision of the future of bar turning.



in Brief

	SwissDECO 26	SwissDECO 36
Max. bar capacity	25,4 mm	32 mm
Max. bar capacity (without guide bush)	26 mm	36 mm
Spindle rotation speed	10.000 rpm	8,000 rpm
Standard workpiece length with rotating guide bush	300 mm	300 mm
Standard workpiece length without guide bush	48 mm	38 mm
Total number of tool positions (SwissDECO G, dual platten)	38	38
Positions for rotating tools (SwissDECO G, dual platten)	27	27
Total number of tool positions (SwissDECO T, turret)	57	57
Positions for rotating tools (SwissDECO T, turret)	36	36

Your benefits

- Identical spindle and counter spindle with asynchronous motors
- Infinite possibilities for machining complex parts
- Very high machining power
- Completely modular machining area
- Modular/pre-adjustable tool systems and equipment
- Operation with or without guide bush
- Optional B axis and A axis
- Simultaneous five-axis machining (option)

Kinematics

- 9 linear axes + 2 C axes
- Optional B axis or A axis
- 3 Z axes
- 3 independent tool systems
- Polygon operation
- Thread whirling
- Deep drilling
- Angled milling
- Gear hobbing

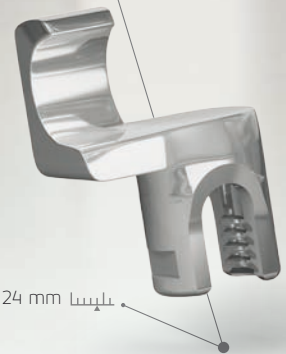

Medical & Dental

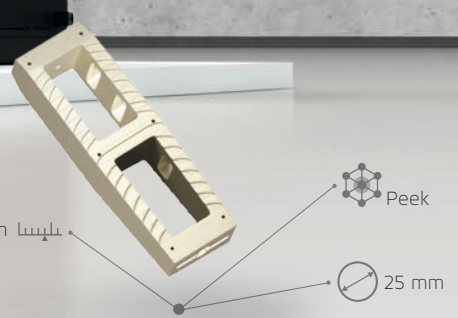

33 mm

Peek

25 mm

Medical & Dental

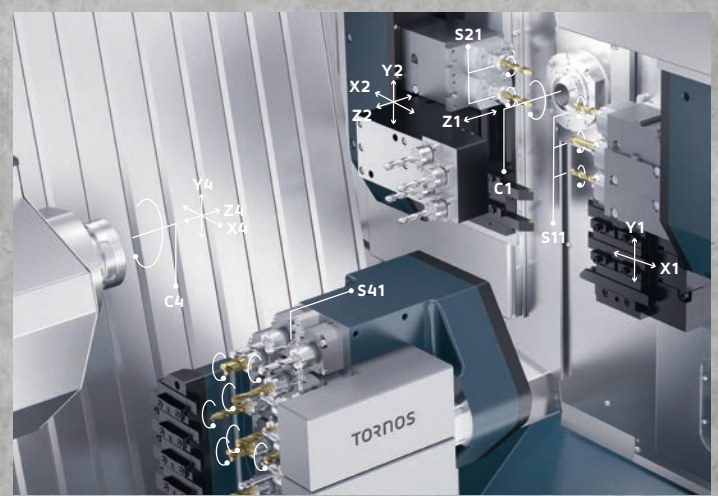

SwissDECO G

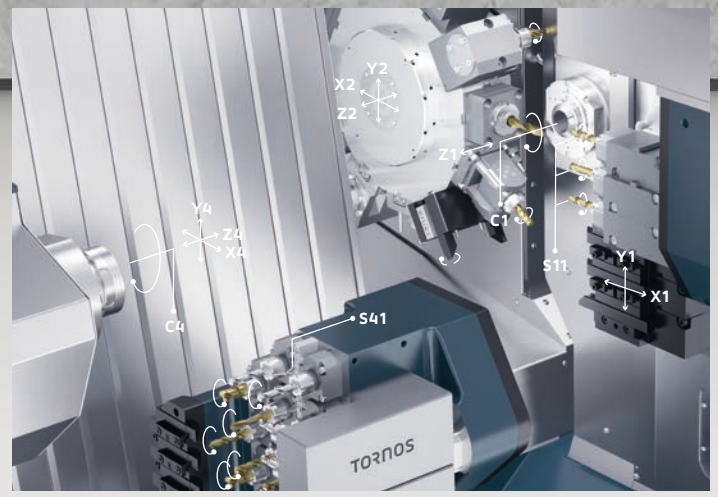

SwissDECO T

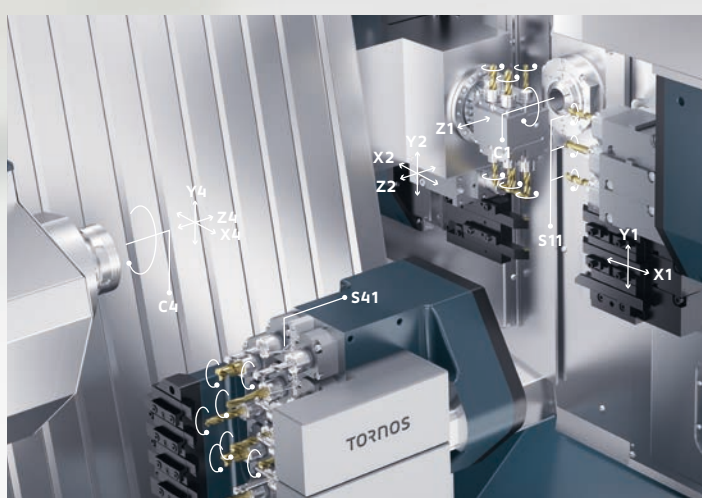

SwissDECO G with A axis

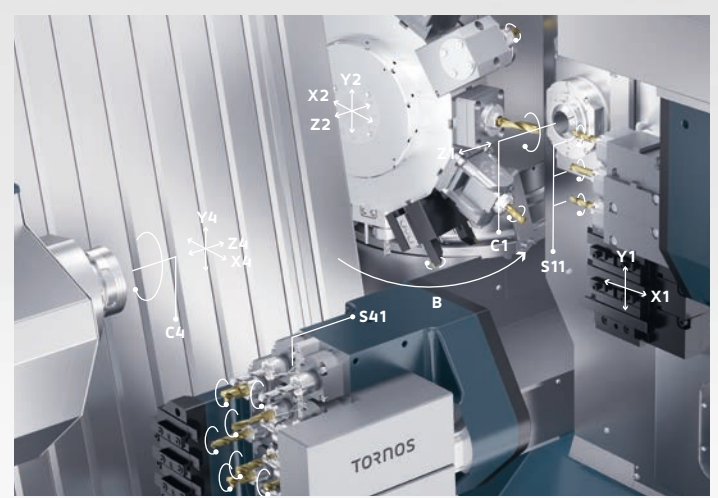

SwissDECO TB

Our heritage

2001

Tornos-Bechler becomes Tornos;
Initial public offering at SIX Exchange

1996

Presentation of the DECO 10

1981

Tornos merges with Bechler
to create Tornos-Bechler

1971

Tornos merges with Petermann,
a longtime competitor in Moutier

1914

Establishment
of Tornos

1880

The Swiss-type lathe
is born in Moutier

1850 1900 1950 1960 1970 1980 1990 2000

2008

Acquisition of Almac, high-precision micro-milling machine manufacturer in La Chaux-de-Fonds

2012

Presentation of the MultiSwiss 6x14

2014

Presentation of the SwissNano

Establishment of Tornos Xi'an (China)

100th MultiSwiss delivered

2015

Tornos enters mid-range segment with own standard machines Swiss GT / Swiss DT

2016

Successful expansion of the MultiSwiss range

2017

TISIS software propels Tornos into Industry 4.0

EMO 2017 marked the world premiere of Tornos' new SwissDECO multitasking single-spindle lathe

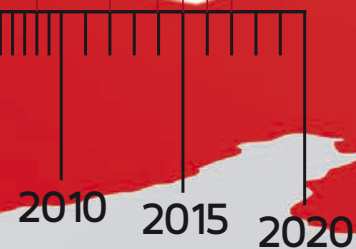

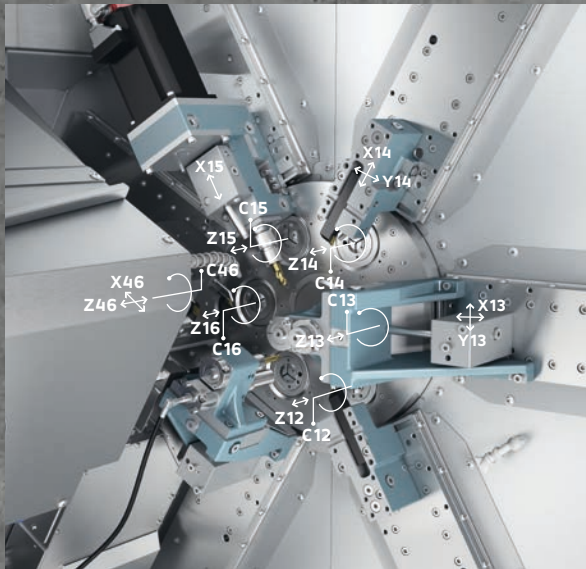

MultiSwiss 6x16

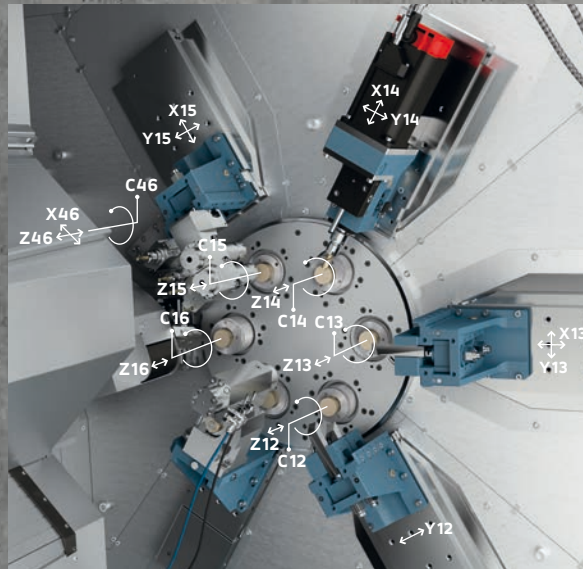

MultiSwiss 6x32

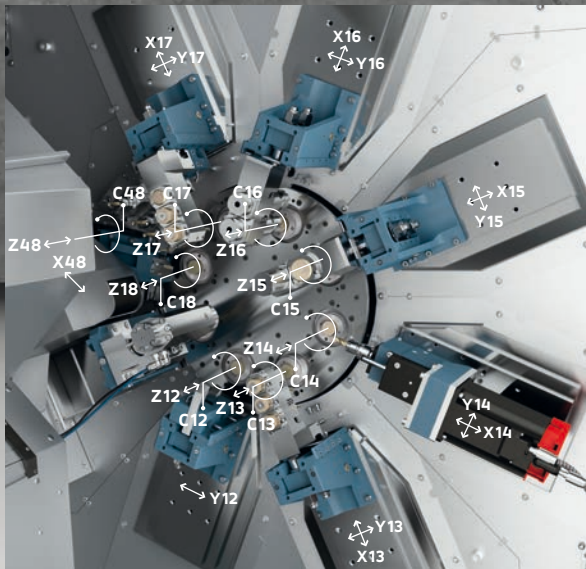

MultiSwiss 8x26

Revolutionizing the multispindle concept

Conceived as a link between multispindle and single-spindle machines, the MultiSwiss has six or eight mobile spindles using torque motor technology to index the barrel. This fast solution delivers cycle times equal to those of cam-operated multispindle turning machines.

Due to its hydrostatic technology, the MultiSwiss achieves exceptional ($Ra\ 0.15$) finishes and outstanding tool adherence even with difficult-to-machine materials. And you won't need a multispindle machine expert to program the MultiSwiss: It's easy to set up and adjust and is programmed just like six machines with three linear axes.

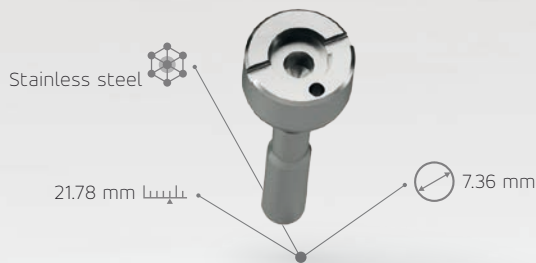

Automotive

MultiSwiss range



in Brief	MultiSwiss 6x16	MultiSwiss 8x26	MultiSwiss 6x32
Bar passage	16 mm	26 mm	32 mm
Max. workpiece length	40 mm	65 mm	65 mm
Max. main spindle speed	8.000 rpm	8.000 rpm	8.000 rpm
Main spindle power	5.6 kW	11 kW	11 kW
Number of linear axes	14	18	14
Number of Y axis	1 (option)	3 / 6 (option)	3 (option)
Number of rotating axes (C Axis)	6 + 1	8 + 1	8 + 1
Number of cross slides in main operation	5 + 1 (cutting)	7 + 1 (cutting)	5 + 1 (cutting)
Max. number of tools	18	31	23
Max. number of tools for back operation	2	4	4
Max. number of rotating tools for back operation	1	2	2

MultiSwiss range

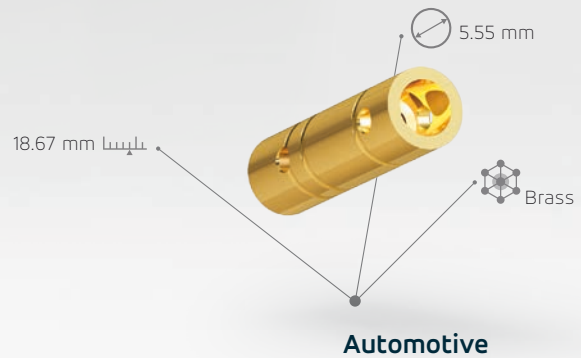
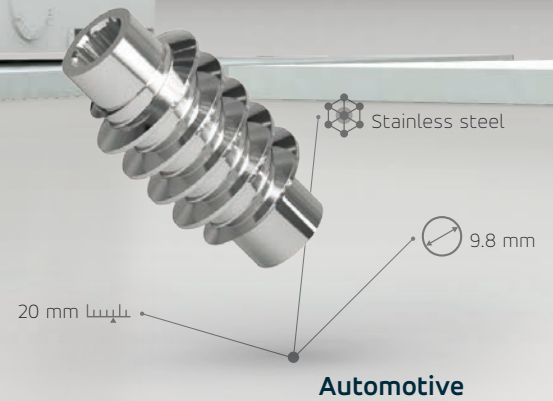
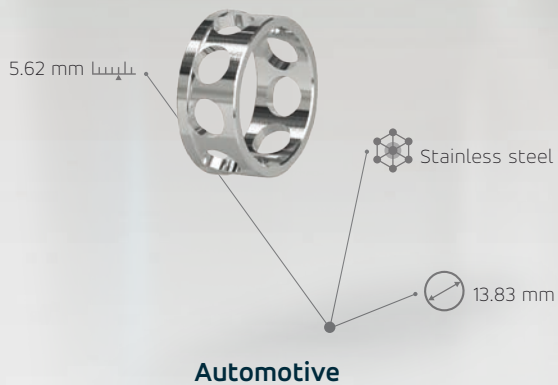
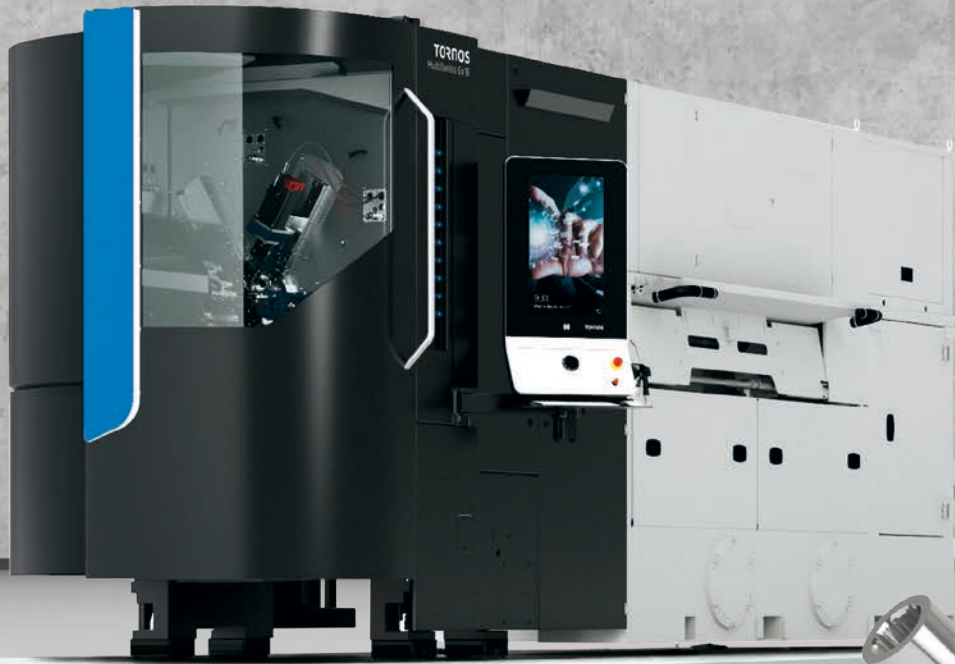



Your benefits

- Rapid barrel indexing thanks to the torque motor
 - Ultra-dynamic synchronous motorspindles
 - Thermo regulated machine core
 - Mobile spindles with hydrostatic bushing
 - Plug & Run system for devices
 - All-in-one machine concept including the bar feeder, oil tray and filtration
 - Small footprint
 - Easy frontal access to tools
 - Chucker option
 - Y axis option for greater flexibility
-

Kinematics

- MultiSwiss machines are all equipped with independent, mobile spindles with hydrostatic bushing. The Z axis is particularly useful when working on long parts which are hard to reach using conventional multispindle machines. In each machining position, the operator can tailor the speed and machining conditions as required.
 - Each spindle is equipped with a C axis. The machine's hydrostatic technology offers exceptional dampening performance when machining, improving the finishes achieved while extending the tools' life span - particularly when machining hard materials. This efficient technology has a proven track record on the MultiSwiss 6x14 and Multi-Swiss 6x16 machines: tool wear is reduced by over 30%, and up to 70% in some extreme cases. This minimises machine stoppages.
-

SwissNano Range

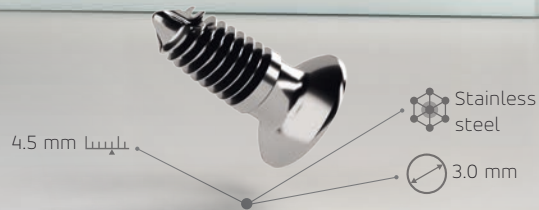

Medical & Dental

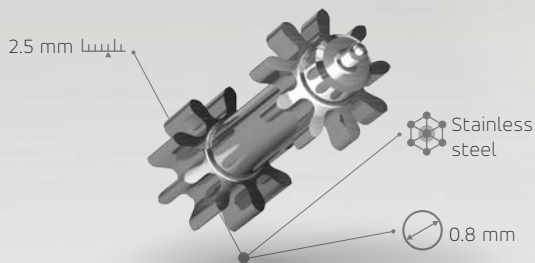

Micromechanics

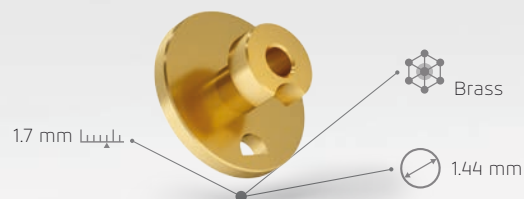

Micromechanics

in Brief

SwissNano 4

Max. bar capacity	4 mm
Spindle rotation speed	16.000 rpm
Standard workpiece length with rotating guide bush	28 mm
Total number of tool positions	14
Positions for rotating tools	2

Your benefits

- Work with or without guide bush
- Exceptional thermal stability and high precision
- Frontal access allowing complete freedom of action
- Optimized kinematics for producing watch and high precision parts
- Unique and customizable design
- The smallest footprint on the market
- Ideal replacement of cam-type lathes

The micro- and nano-precision specialist

Designed to meet the demand for small, very high-precision workpieces. The SwissNano's kinematics enable production of two-thirds of watch movements—from the simple to the most complex, including cutting—with excellent finishes. It's perfect for any workpiece requiring extreme quality and precision, thanks to kinematics delivering exemplary balance and thermal management for quick arrival at operating temperature.

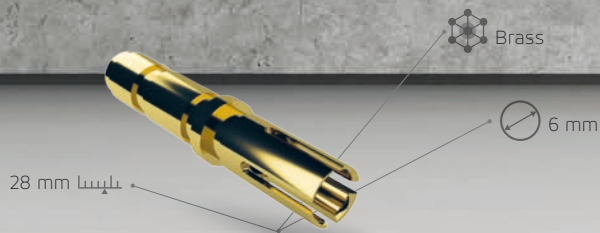

SwissNano 7

7 mm

16.000 rpm

50 mm

20

5

Electronics

Kinematics

- 6 linear axes + 2 C axis
- 2 independent tool systems
- Gear hobbing
- Thread whirling and polygon milling
- HF spindle

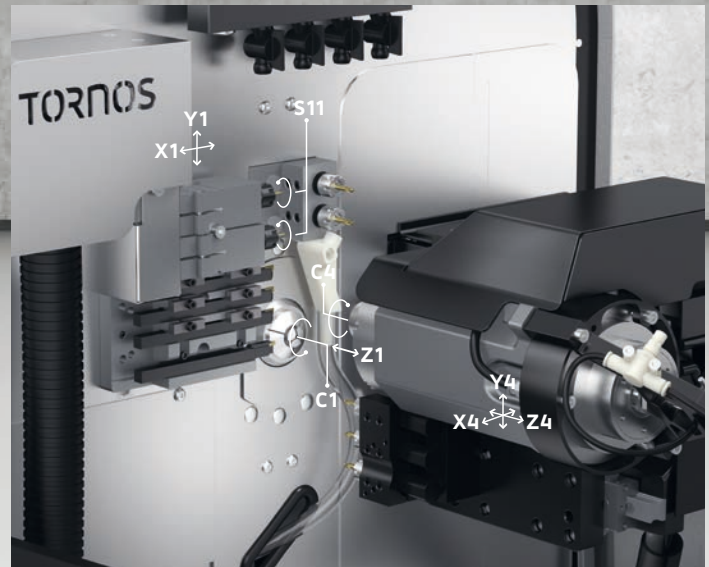

SwissNano 4

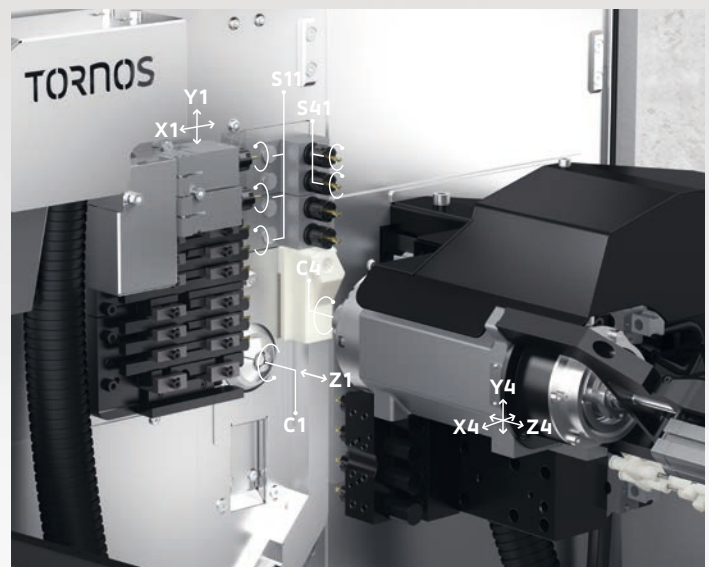

SwissNano 7



TISIS – Communicate with your machines



Programming

Able to manage up to three channels, the ISO editor automatically synchronizes the code between the channels and uses syntax highlighting to enable value codes to be easily distinguished.

Selecting your tools

The TISIS database contains all of the tool resources; for example chisel holder plates, thread whirling tools, polygon tools or milling tools are all integrated. TISIS manages incompatibilities between the various tools and the user is guided intuitively.

Transfer

Transfer virtual programs to your bank of machines. Modify the program on the machine and transfer it again to your computer, maintaining full traceability.

Monitoring

Monitor your machine inventory in detail. See the status of the machines in the workshop and an overview of current production; the workpiece counter, remaining production time and the name and drawing of the workpiece are available at any time.



Discover the
TISIS video

A global footprint

Rooted in Switzerland, Tornos' global footprint keeps us close to you. Economy, flexibility and efficiency are the most important premises of the Tornos Group's production and assembly network.

Lean assembly and careful use of resources are the guiding principles behind all Tornos production planning and an integral part of the entire production process.

The same consistent quality standards are enforced at all locations around the globe. Intelligent linking of knowledge between our plants, along the commitment and know-how of our employees—enable production to begin right on time.

Wherever you are in the world, we keep you turning.



Moutier

Our Moutier site—using the latest production technologies and equipment—produces the key components of our world-renowned machines and assembles our high-end automatic turning machines and other multispindle solutions. Key components stamped “made in Switzerland” are produced in Moutier for all of our production sites.





Xi'an

Our Xi'an, China site's special testing and development center allows it to fit out machines to customer specifications. In Xian, we produce standard products delivering great value for the money on a global scale.



Taichung

In Taichung, Taiwan—a city with a long machine tool-making tradition and broad network of suppliers—Tornos produces mid-range machines. Our Taichung facility's services include customization, setup, designing models, and on-site testing of machines produces. Key components of our machines produced in Taichung are sourced from our Moutier production site.



Tornos Service

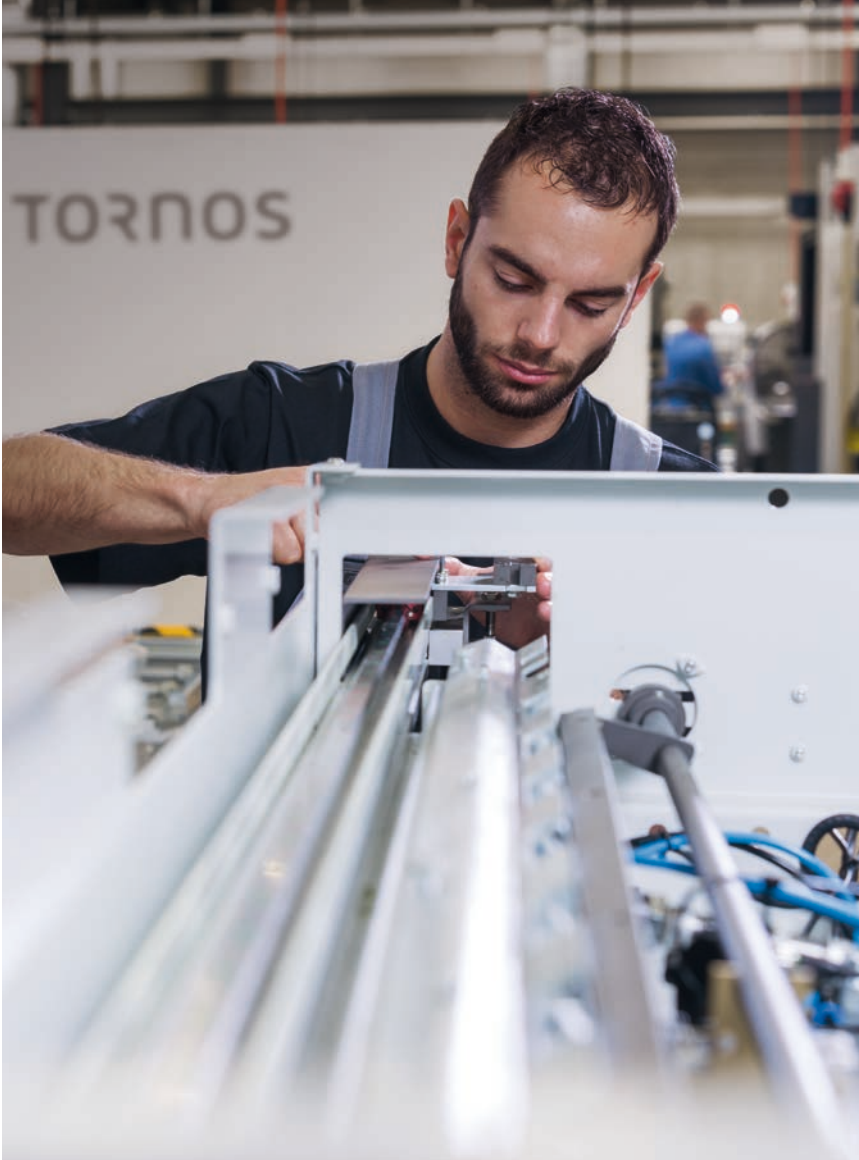

Backed by both geographical proximity to customers and a keen understanding of their processes, applications and market challenges, Tornos Service delivers an unparalleled continuum of support: start-up assistance, expert training and coaching, free hotline, on-site operations support and preventive maintenance, original spare parts seamlessly delivered worldwide, complete overhauls to extend the service life of Tornos machines, and a range of operations and X-change modules to expand customers' application capabilities and profitability.

Buying a Tornos machine is much more than a business transaction. It is your investment in the future. Tornos Service thrives worldwide on securing the predictably high production capability of products carrying the Tornos name.

Situated close to its customers, as demonstrated by the 14 Tornos Service Centers strategically located across Europe, Asia, and the Americas, Tornos Service offers a full continuum of authoritative support for Tornos machines, and encompasses the innovation, reliability and attention to detail expected of a premier Swiss brand. And it is all backed by a 100-year legacy of expertise and in-depth understanding of customers' processes, applications and challenges across a wide range of industrial segments, including automotive, medical, electronics and connectivity, and micromechanics.

Start-up assistance

From the first feasibility tests prior to purchase, you are in good hands with Tornos Service. In our state-of-the-art Techno Centers, expert application engineers support you with tests to gauge the feasibility of machining processes and applications. With start-up assistance, you are secure in the knowledge that you will never be left alone to deal with a brand new machine.

Expert training and coaching

Engineered for intuitive and easy use, Tornos machines offer a vast range of options and enable myriad processes. Expert training and coaching help your employees become specialists proficient in programming, handling and maintenance, adding more value to your processes, applications and products.

Free Hotline support

Wherever you are in the world, highly qualified specialists who speak your language and understand your processes are just a phone call away to quickly support you with handling and programming solutions.

On-site support

Fast, efficient on-site operations and preventive maintenance ensure the continuous high performance of your Tornos machines. Regular scheduled preventive maintenance can help you avoid 70 percent of machine breakdowns and keep you on the path to productivity.

Certified original spare parts

Rapid, reliable, worldwide delivery of certified original spare parts is a specialty of Tornos Service. Regardless of the age of your Tornos machine, we stock the essential certified spare parts to keep the machine running at peak performance.

Machine overhauls

Tornos machines inspire confidence. It's no surprise, therefore, that many customers turn to Tornos for a complete overhaul of their machines. The Tornos overhaul service returns the machines in good-as-new condition, appreciably extending their service life.

Options, upgrades and X-change Modules

To help you achieve your manufacturing, productivity and quality objectives, our experts collaborate with you to manage complex machining processes, develop software features for machining complex shapes, design special equipment, and tailor peripherals to your needs. Tornos' X-change Modules expand your application capabilities and profitability.

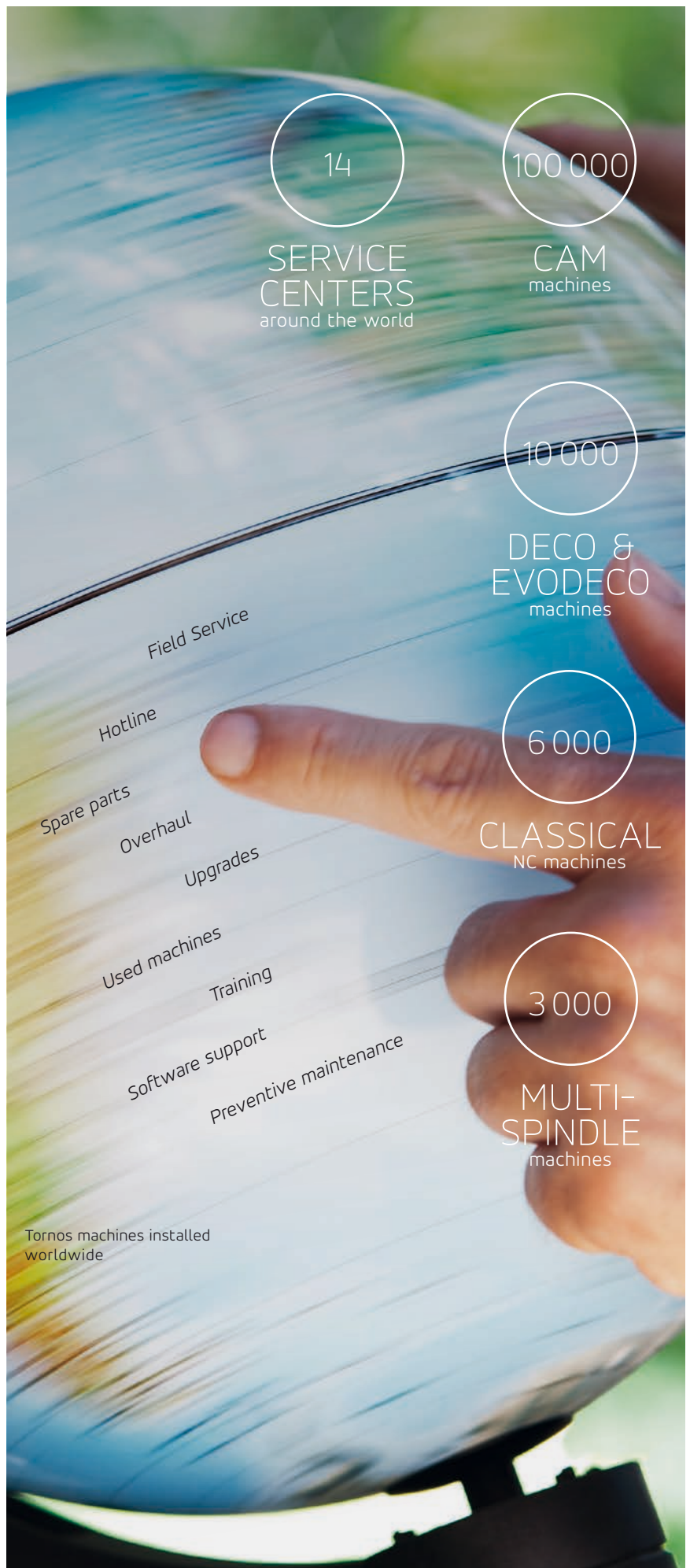

Discover
Tornos Service

We keep you turning

TORNOS LTD

Rue Industrielle 111
P.O. Box 960
2740 Moutier / Switzerland
T +41 (0)32 494 44 44
contact@tornos.com

Tornos
throughout
the world



tornos.com