

KUBOTA WHEEL LOADER R070 / R090



Engine output (PS):

R070: 50.8

R090: 64.3

Machine weight (kg):

R070: 4,445

R090: 4,945

Comfort, easy operation, and all the power you need.

Kubota's next-generation R070 and R090 wheel loaders are built to get the job done quickly, easily, and efficiently. They're built for comfort, with a new, high-visibility cabin. They're also built for safe and simple operation, even by operators with no loader experience. And they're built for performance, with enhanced productivity features and power to spare.



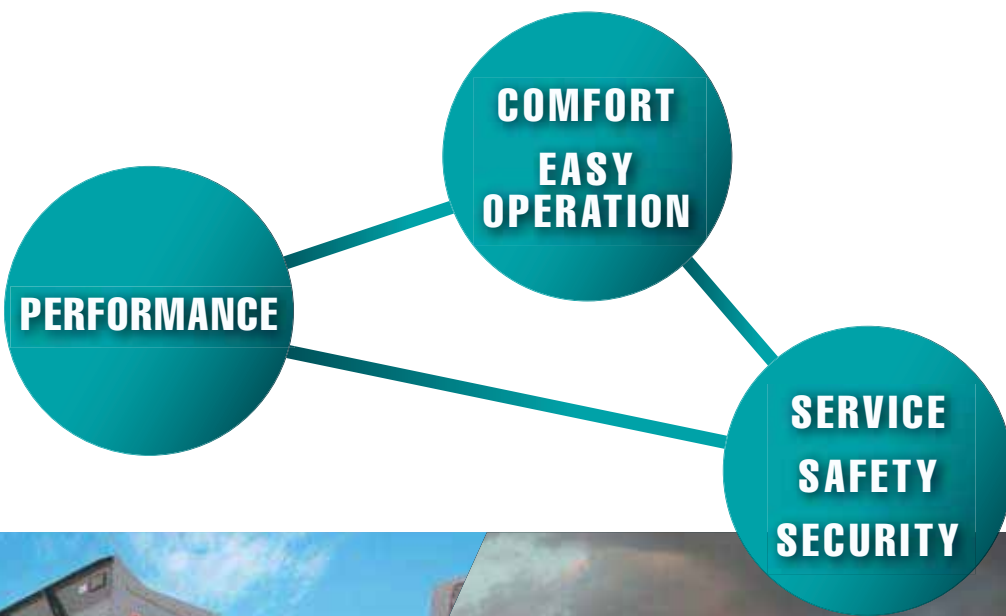

KUBOTA WHEEL LOADER

**R070
R090**

COMFORT / EASY OPERATION

Redesigned inside and out, both the R070 and R090 wheel loaders boast a fully enclosed glass cabin for improved visibility, as well as a more ergonomic control layout.

HIGH-VISIBILITY CABIN

Fully enclosed in glass, the high-visibility cabin offers the operator a panoramic perspective of the environment outside, with the pallet fork tips clearly visible from the driver's seat. The full glass door, and wide opening window provide excellent visibility to the left and right, whilst the rear window offers an unobstructed view when reversing.



FULL OPENING RIGHT WINDOW

The window on the right side of the cabin opens fully to improve ventilation as well as communication with workers outside.



NEW LIFT ARM DESIGN

A new "Delta" lift arm design allows the operator to easily see the hydraulic quick-coupler pins. Rerouted hydraulic piping improves visibility of the toe during pallet fork operations.

TION

NEW INTERIOR DESIGN

The spacious cabin's ergonomic layout is designed to keep you working comfortably from start to finish.



DIGITAL DISPLAY

Bright and easy-to-read, the digital instrument panel tells you at a glance everything you need to know about the machine's functions and conditions. A full set of diagnostic indicators automatically monitor critical machine conditions, letting you concentrate on the job at hand.

LARGE FOOT SPACE

Plenty of space for the feet means greater comfort for the operator. And that means greater productivity during those long days on the work site.

ENLARGED GLASS SURFACE

The areas of clear glass on the front and side panels have been enlarged to improve visibility.

AIR CONDITIONING (option)

A powerful cooling/heating system and eleven vents provide optimum comfort on the coldest winter and hottest summer days.



ADJUSTABLE RIGHT WRIST REST

This feature reduces fatigue by reducing arm movement and allowing you to more easily operate the hand lever.

FULL-SUSPENSION SEAT

A full-size, full-suspension adjustable seat enhances operator comfort. The padded seat can be moved forward or back for optimum comfort.

TILT STEERING

With the flick of a lever, the steering wheel can be tilted up or down to the most comfortable and efficient position for drivers of all sizes.

PERFORMANCE

Long reach and excellent lifting power ensure superior performance for a wide range of loader tasks.

WORKING RANGE

A long reach and high clearance make all types of material handling jobs easy. The long reach and high clearance lets you load trucks with ease, whilst the superior reach makes pallet fork operations faster and more efficient.



R070: 3230 mm
R090: 3230 mm

LIFTING CAPACITY

A strong lifting force provides both R070 and R090 smooth lifting and re-handling of heavy materials onto a wide variety of trucks.

R070: 1880 kgf
R090: 2160 kgf
(Max. payload 80%)

MULTI-FUNCTION OPERATING LEVER

All major loader functions are on a single lever that is easy to operate with just one hand, both on the R070 and R090. The 2-step speed control switch lets you quickly change speeds, allowing you to operate at optimum efficiency for the task at hand.

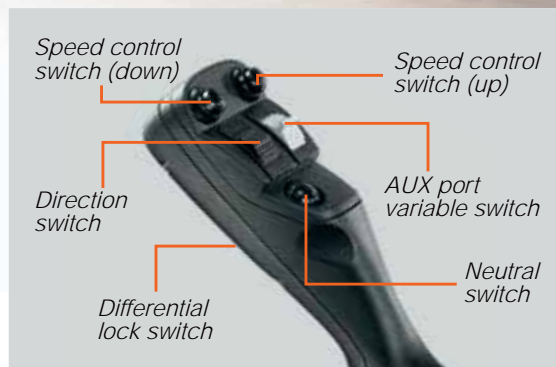



KUBOTA ORIGINAL DI ENGINE WITH CRS AND DPF MUFFLER

Equipped with CRS and DPF, Kubota's V2607 direct-injection engine is now fully Stage-V compliant. The new and improved DPF reduces maintenance by increasing the service intervals for both the regeneration filter and ash cleaner.



ENGINE OUTPUT

R070: 50.8 PS

R090: 64.3 PS

ARM TILT / PARALLEL MOVEMENT

Transporting a fully loaded pallet with the pallet fork, Kubota's arm tilt/parallel movement structure keeps the load upright and steady, even while raising or lowering the lift arm.

DIFFERENTIAL LOCK (100% on demand, front + rear)

Should the wheels start to slip, simply press the differential lock switch to immediately engage both front and rear wheels. The result is positive slip-free traction.

SERVICE / SAFETY SECURITY

Simple maintenance, enhanced safety, and dependable security features ensure that your R070 and R090 loaders are productive, safe, and secure.

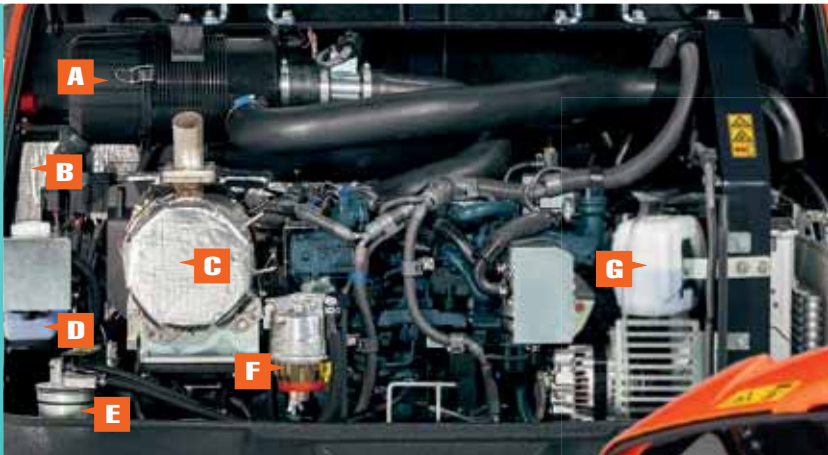

- A DUAL ELEMENT AIR CLEANER**
- B BATTERY**
- C DIESEL PARTICULATE FILTER (DPF) MUFFLER**
- D WASHER TANK**
- E FUEL FILTER**
- F WATER SEPARATOR**
- G RESERVE TANK**



EASY MAINTENANCE

The engine bonnet at the rear opens wide, providing quick and easy access to the machine's main service areas. Items that require routine maintenance and service are within easy reach for fast and simple servicing. Quick-open panels on the right and left sides provide speedy access to the fuel refill (right side) and battery (left side). Other areas of the R070 and R090 are also easy to service and maintain.

DIGITAL DIAGNOSTIC INDICATORS

A bright easy-to-read digital diagnostic indicator keeps you fully informed of critical loader and engine conditions.

• Error display



Hydraulic oil temperature has reached a specified level

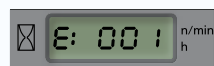

Meter ECU communication error



Parking brake error

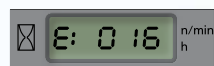

Fuel sensor system error



SIMPLE AND SECURE TRANSPORTATION

With an overall height below 2500 mm, the R070 and R090 slip easily under road bridges for fast and safe transportation between job sites. Six tie-down points allow simple yet secure attachment to a truck bed for safety during transportation.



NEW LED WORK LIGHTS

Bright LED work lights provide plenty of illumination for nighttime tasks.



SEAT BELT ALARM AND HIGH-VISIBILITY SEAT BELT

The bright orange seat belt is a visual reminder for site safety personnel to alert if the seatbelt is being worn before the starting of the engine by the operator. Should this be forgotten, a warning function will prompt the operator to fasten it.



KUBOTA ANTI-THEFT SYSTEM

Only programmed keys will enable the engine to start up. Attempting to start with an un-programmed key will activate the alarm. Its features include an alert to remind the operator to extract the key after operation, and an LED to alert potential thieves that the system is activated.

Protected by KUBOTA
ANTI-THEFT
SYSTEM



Standard and optional equipments

● Standard equipment Optional equipment

Model	R070	R090
Engine/Fuel system		
KUBOTA original engine (Stage V)	●	●
Double-element air cleaner	●	●
Fuel level indication buzzer	●	●
Travel system		
Changeable 2 level-travel speeds	●	●
Differential lock (100% on demand, front and rear)	●	●
Wet type disc brake	●	●
Negative brake (parking brake)	●	●
Hydraulic system		
Hydrostatic transmission	●	●
Multi function operating lever with AUX proportional control	●	●
Hydraulic lock switch	●	●
Inching and brake pedal (left)	●	●
Attachment unlock switch	●	●
Float switch	●	●
Cabin		
Cabin with heater	●	●
Cabin with air conditioner		
2 front LED working lights on the cabin	●	●
Weight-adjustable suspension seat (fabric seat) with left arm rest and back rest	●	●
Retractable orange seatbelt with alert function	●	●
Adjustable right wrist rest	●	●
Digital panel with diagnosis function	●	●
ROPS (Roll-over Protective Structure, ISO3471)	●	●
FOPS (Falling Object Protective Structure, Level1, ISO3449)	●	●
Radio installation (bracket, speaker, antenna, harness)	●	●
Side mirrors	●	●
Emergency exit hammer	●	●
12V power outlet	●	●
Sun visor	●	●
Tilt steering	●	●
Beacon light		
Canopy		
Weight-adjustable suspension seat (PVC seat) with left arm rest and back rest	●	●
Retractable orange seatbelt with alert function	●	●
Adjustable right wrist rest	●	●
Digital panel with diagnosis function	●	●

Model	R070	R090
Working equipment		
ROPS (Roll-over Protective Structure, ISO3471)	●	●
FOPS (Falling Object Protective Structure, Level1, ISO3449)	●	●
Side mirrors	●	●
12V power outlet	●	●
Tool storage space (under seat)	●	●
Tilt steering	●	●
Beacon light		
Working equipment		
2 Head lights (Headlights and Signal Lights)	●	●
Hydraulic quick coupler	●	●
Z-bar linkage with parallel movement	●	●
Rear combination light (Turn signal, Tail light, Brake light, Back light)	●	●
Bucket level indicator	●	●
Safety valve for lift arm		
Safety		
6 Tie down points	●	●
Wheel chock	●	●
Lift arm support	●	●
Battery isolator	●	●
Towing pin	●	●
Others		
KUBOTA original anti-theft system	●	●
Maintenance free battery	●	●
Grease gun holder	●	●
Cup holder	●	●
Brake pedal (right)		
Creeping speed function		
Shock absorber for lift arm		
Tool box		
Rear LED working lights		
Power socket for attachment		
Special color		
Various tyres		
Multipurpose: 12.5-20 317MPT (Alliance)		
Industrial: 405/70 R18, SPT9 EM (Dunlop)		
Agriculture: 400/70 R20, XMCL (Michelin)		
Various buckets and other attachment on request		

Specifications

Model		R070	R090
Operating weight (canopy/cabin)*1	kg	4355 / 4520	4855 / 5020
Bucket capacity	m ³	0.65	0.85
Engine			
Manufacturer		Kubota	Kubota
Model		V2607-CR-E5-WL	V2607-CR-TE5-WL
Output (ISO 14396:2002)	kW	37.4	47.3
	PS	50.8	64.3
Number of cylinders		4	4
Displacement	cc	2615	2615
Transmission			
Type		Hydrostatic transmission	Hydrostatic transmission
Operational specifications with bucket			
Tipping load, straight (ISO14397-1) (canopy/cabin)	kg	3280 / 3440	3760 / 3920
Tipping load, full turn (ISO14397-1) (canopy/cabin)	kg	2880 / 3020	3300 / 3440
Max. lifting capacity at ground level	kN	30.1	36.3
Breaking force (ISO14397-2)	kN	36.4	43.9
Operational specifications with pallet fork			
Tipping load, full turn (ISO14397-1) (canopy/cabin)	kg	2240 / 2350	2590 / 2700
Max. payload (EN 474-3) 80%	kg	1790 / 1880	2080 / 2160
Max. payload (EN 474-3) 60%	kg	1340 / 1410	1560 / 1620

Model		R070	R090
Travelling			
Tyre size		12.5 – 18	12.5 – 18
Travelling speed (forward / reverse)	km/h	0 to 20.0 / 0 to 20.0	0 to 20.0 / 0 to 20.0
Traction force	kN	29.1	38.2
Front / rear axle		Diff. lock 100% on demand	Diff. lock 100% on demand
Angle of oscillation	Deg.	± 8	± 8
Auxiliary circuit			
Max. flow rate	l/min	54.0	67.2
Max. hydraulic pressure	MPa	18.5	20.5
Noise level			
Sound pressure level (LpA)(canopy/cabin)	dB (A)	83 / 77	80 / 77
Sound power level (LwA (2000/14/EC))	dB (A)	100	100
Hand arm system vibration*2	m/s ²	<2.5	<2.5
Whole body vibration*2	m/s ²	<0.5	<0.5
Capacity			
Fuel tank	l	70	70
Hydraulic oil tank	l	39	39
Hydraulic oil tank, incl. hydraulic system	l	55	57
Engine oil	l	9.0	9.0
Front / rear axle oil	l	6.3 / 6.9	6.3 / 6.9

*1 With general purpose bucket (R070: 289kg / R090: 329kg) and 75 kg operator.

*2 These values are measured under specific conditions at maximum engine speed and can deviate, depending on the operating status. The above values apply to a machine with standard tyres, bucket and quick coupler.

Bucket

Model	R070				R090				
	Type of bucket	General purpose bucket (std)	General purpose bucket (wide)	4 in 1 bucket (std)	4 in 1 bucket (wide)	General purpose bucket (std)	General purpose bucket (wide)	4 in 1 bucket (std)	4 in 1 bucket (wide)
Capacity	m ³	0.65	0.68	0.6	0.62	0.85	0.88	0.8	0.83
Width	mm	1750	1820	1750	1820	1820	1890	1820	1890
Weight	kg	289	297	505	516	329	338	556	568
Bulk density	t/m ³	1.9	1.8	1.8	1.7	1.9	1.8	1.75	1.67

Recommend tyre	12.5-18 317 MPT (Alliance)	365/70 R18 SPT9 EM (Dunlop)	12.5-18 317 MPT (Alliance)	365/70 R18 SPT9 EM (Dunlop)	12.5-18 317 MPT (Alliance)	405/70 R18 SPT9 EM (Dunlop)	12.5-18 317 MPT (Alliance)	405/70 R18 SPT9 EM (Dunlop)
	12.5-20 317 MPT (Alliance)	340/80 R18 XMCL (Michelin)	12.5-20 317 MPT (Alliance)	340/80 R18 XMCL (Michelin)	12.5-20 317 MPT (Alliance)	400/70 R20 XMCL (Michelin)	12.5-20 317 MPT (Alliance)	400/70 R20 XMCL (Michelin)

Pallet fork

Model	R070	R090
Fork length	mm 1200	mm 1200

Working range

With Bucket Attachment	R070	R090
	General purpose bucket Standard width	General purpose bucket Standard width

Machine dimension			
A Overall length	mm	5395	5485
B Wheelbase	mm	2000	2000
C Tread	mm	1355	1400
D Overall height (canopy / cabin)	mm	2460 / 2480	2460 / 2480
E Ground clearance	mm	330	330
F Overall width (outside of tires)	mm	1680	1725
G Overall width (bucket)	mm	1750	1820

Working range			
H Dumping clearance	mm	2525	2465
I Dumping reach	mm	730	790
J Max. hinge pin height	mm	3230	3230
K Max. lifting height	mm	3995	4100
L Digging depth	mm	110	110

Others			
M Tilt back angle (at traveling position)	Deg.	50	50
N Dumping angle	Deg.	45	45
α Articulation angle	Deg.	40	40
Turning radius (tire clearance circle)	mm	3640	3660

With pallet fork attachment			
Fork length	mm	1200	1200

Working range			
A1 Overall length	mm	5895	5900
B1 Height of forks at Max. reach	mm	1370	1370
C1 Height of forks at Max. height	mm	3030	3030
D1 Reach at ground level	mm	810	810
E1 Max. reach	mm	1255	1255
F1 Reach at Max. height	mm	500	500

Specifications are subject to change without notice.
Data is valid with general purpose bucket (standard width) and standard tire (12.5-18").

Fluorinated greenhouse gases				
Air conditioner gas contains fluorinated greenhouse gases.				
CAB model	Industrial designation	Quantity (kg)	CO ₂ equivalent (ton)	GWP
R070/R090	HFC-134a	0.7	1.01	1430

(Global Warming Potential: GWP)

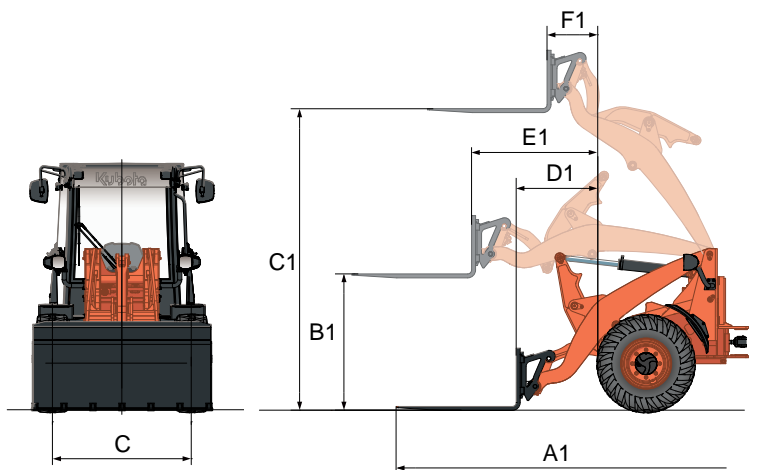
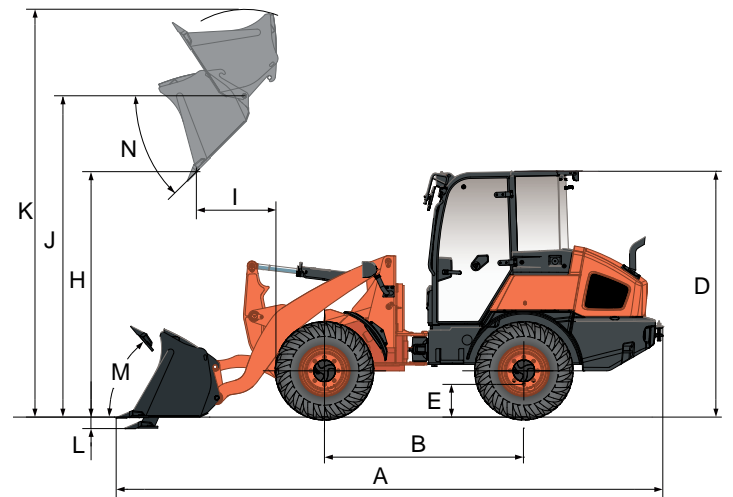
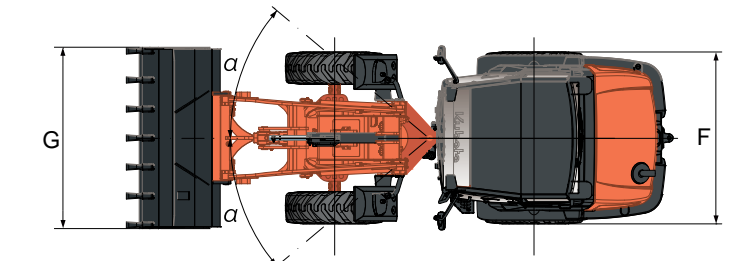

All images shown are for brochure purposes only.
When operating the wheel loader, wear clothing and equipment in accordance to local legal and safety regulations.

Kubota Genuine and Approved Parts
for maximum performance, durability and safety



KUBOTA EUROPE S.A.S.

19, rue Jules Vercreysse
Zone Industrielle - CS50088
95101 Argenteuil Cedex France
Téléphone : (33) 01 34 26 34 34
Télécopieur : (33) 01 34 26 34 99



<https://www.kubota-eu.com>

