



# S.CS/S.PR Curtainsiders

Transport Solutions for General Cargo Transport.



# Contents.

## Multi-talented Trailers for General Cargo.

### 3 Introduction

- 3 The Curtainsider Semi-trailer Redefined.

### 4 The S.CS GENIOS

- 4 The S.CS GENIOS Is Available In Numerous Variants.
- 5 The Benefits of the New S.CS GENIOS Generation.
- 6 The Secret of Success.

### 7 The Modular System

- 7 Altenberge Trailer Competence Centre – Assembly Line Production with Large-Series Quality.
- 8 CVC and Testing – For Our Customer's Safety.

### 9 S.CS UNIVERSAL and MEGA

- 9 S.CS UNIVERSAL – The Basis for Success.
- 10 Useful Equipment for the S.CS UNIVERSAL.
- 11 The S.CS MEGA and S.CS MEGA VARIOS - 100 m<sup>3</sup> Automotive Freight.
- 12 S.CS MEGA with Variable Double-Decker System.



### 13 Remote Control

- 13 S.CS COIL Steel Transport – The Coil Well.
- 14 S.CS COIL – Coil Transport Equipment.
- 15 S.CS PAPER – The Specialist for Paper Transport.
- 16 S.CS PAPER – Paper Logistics Equipment.
- 17 Certified Load Securing for Beverage Transport.
- 18 S.CS Curtainsider Semi-trailer – Also Certified for Keg Transport.

### 19 The X-LIGHT Series

- 19 The S.CS X-LIGHT Model Family: UNIVERSAL, MEGA, COIL, PAPER
- 20 The Equipment for the S.CS X-LIGHT Models.

### 21 Equipment

- 21 The Structural Rigidity is Certified to DIN EN 12642 Code XL.
- 22 Schmitz Cargobull Safety Roof.
- 23 SPEED CURTAIN – Access to the Freight in Moments.
- 24 SPEED CURTAIN – Accident Prevention Integrated into the Tarpaulin.
- 25 SPEED CURTAIN Vehicle with Tail Lift – The Ideal Partner for Beverage Logistics.
- 26 Transport Conformant with Daimler Load Securing Directive 9.5.
- 27 Secure International Transport with TIR Equipment.
- 28 Combined Rail and Ferry Transport.
- 29 The S.PL Flatbed Trailer Reliably Transports Steel for the Construction Industry.
- 30 S.PR Bau – The Robust Carrier for the Construction Industry.

### 31 Technology

- 31 Innovative High-Tech Modular System for every Challenge.
- 32 Know-how and High-Tech Made in Germany.
- 33 ROTOS DriveTechnology.
- 34 Clever Running Gear Steering – MRH, LSP, TIS with Immobiliser.
- 35 Trailer Telematics for the S.CS Curtainsider Semi-trailer.
- 36 TrailerConnect for Your Fleet Management.

### 37 Services

- 37 Our Services for Your Vehicle.

### 38 Contact

- 38 Your Contacts.

## S.CS GENIOS

### The Curtainsider Semi-trailer Redefined.

The new generation is the ideal representation of Schmitz Cargobull's corporate philosophy: perfection with no compromises. What used to be good has now got even better. This applies for the MODULOS chassis, the FLEXOS body, the ROTOS running gear, the load securing and also for the many fine details which ensure that transport tasks go smoothly every day. At the end of this comprehensive optimisation process, we have created a line of vehicles which offers greater strength and durability. Important for day-to-day usage: Handling in the new S.CS GENIOS is now even easier and safer too.



Roll formed components serve to make the body even stronger. The corner profile on the bulkhead and the rear portal frame utilise newly developed steel profiles which are even more durable, thanks to the roll forming.



The new profiles on the rear portal also provide protection for the now recessed hinges when approaching a ramp.

## Multi-talented.

The S.CS GENIOS Is Available In Numerous Variants.

Among Schmitz Cargobull's extensive range of curtainsiders the S.CS GENIOS plays a role in the most important transport tasks from the outset. As always, you can select the various equipment options for the S.CS GENIOS in order to customise the semi-trailer to meet your precise requirements. We can address your needs at short notice thanks to the new, innovative production methods. This seamlessly merges the boundary between customisation and series production.



As always, the S.CS GENIOS is also available with all of the equipment options for your day-to-day transport tasks. In addition, the S.CS GENIOS can also be equipped with the SPEED CURTAIN on one or both sides.

## Master.Piece.

### The Benefits of the New S.CS GENIOS Generation.

With the new S.CS GENIOS trailer the customer benefits often begin with the details. That is why many improvements are the result of painstaking attention to detail for every component. These enhance the ground-breaking innovation of the MODULOS chassis and round out the unique experience of an efficient and reliable transport solution.



The new Schmitz Cargobull Safety Roof with integrated diagonal reinforcement through high strength plastic increases the structural strength to such an extent that the SPEED CURTAIN body and the double-decker equipment can be used without the previous roof reinforcements. This simplifies the handling when opening and increases the amount of usable interior height.



# Technology and Passion.

## The Secret of Success.

A new product generation is not created overnight and cannot simply be developed on the drawing board. Decades of experience, a feel for the market, know-how and an openness for technological progress allow innovation to develop organically. Every trailer reflects our employees' enthusiasm by handling the tough transport conditions day in and day out.



## We Manufacture Customised Series Models.

Altenberge Trailer Competence Centre – Assembly Line Production with Large-Series Quality.

Tailored transport solutions for your industry are created using industrial manufacturing cycles based on an efficient modular system. State-of-the-art manufacturing technology offers you premium quality and product reliability.

To safeguard this quality, our testing processes are oriented on the certified testing standards of tractor and passenger vehicle manufacturers.

The manufacturing depth up to and including our own axle production at the Altenberge plant proves that we make no compromises when it comes to quality.



High-precision units: The ROTOS axles developed and produced in-house.



Fitted with the highest precision running gear.



Serial production component assembly.

## Our Uncompromising Products.

### CVC and Testing – For Our Customer’s Safety.

Is life all about making compromises? Not for us! At the Schmitz Cargobull Validation Center (CVC) – located next to our main plant in Altenberge – we manufacture prototypes, make measurements, perform trials and test parts, components and entire vehicles for as long and as intensively as necessary until we are uncompromisingly satisfied with the quality. Because our products are designed to support your transport business with maximum benefits and minimum TCO (total cost of ownership).

We go to great lengths to ensure your satisfaction with our products: This includes a realistically simulated route covering 1,000,000 km which our trailers must travel while fully loaded within the space of only a few weeks. Torture for the vehicle body and running gear! Which is as it should be. Because these and other tests ensure that you can be certain that you receive technically mature S.CS curtain-sider semi-trailers from Schmitz Cargobull which carry out your transport tasks to your complete satisfaction, without making any compromises.



Tests with extreme driving manoeuvres are required in order to optimally coordinate the assistance systems.



Our in-house testing centre in Altenberge – The Schmitz Cargobull Validation Center.



Test distance: 1,000,000 km. The results on the hydropulsers help to optimise the entire vehicle.



## The All-Rounder for Almost any Freight.

### S.CS UNIVERSAL – The Basis for Success.

Easy loading, rapid load securing, a high-strength body with solid bulkhead ram protection and reinforced corner supports make the S.CS UNIVERSAL the cost-efficient all-rounder for the general cargo business.

The lashing rings along the outer frame, the recessed lashing eyes and the optional pallet stop also provide additional load securing options. When transporting interlocking complete loads the S.CS UNIVERSAL does not require any additional load securing.



Body strength certified to DIN EN 12642 Code, fulfils the VDI Directive for beverage transport and the Daimler Directive DL 9.5 for transporting freight on load carriers.

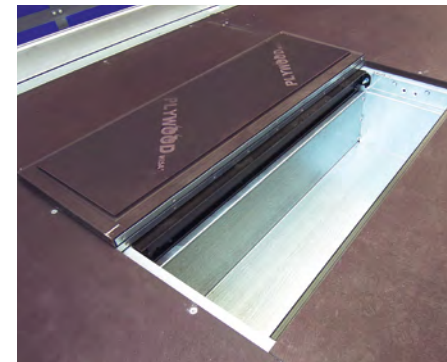

The optional storage box on the vehicle floor creates space for the lashing material, for example.



The high-strength aluminium bulkhead with wood or steel ram protection can absorb forces of up to 13.5 tonnes.

## Well Planned Down to the Last Detail.

### Useful Equipment for the S.CS UNIVERSAL.

Our tested equipment options enable you to specifically configure your S.CS UNIVERSAL to match the unique requirements of your day-to-day transport business. This begins with those expansions which improve your efficiency when handling the load. These options include the tail lift, the forklift mounting, storage space for load securing material and the pallet boxes, so that return freight can be transported without any loading capacity restrictions. ADR-conformant equipment for transporting hazardous goods is also available and provides greater flexibility. One important feature for energy-conscious driving is the aerodynamic roof spoiler which delivers significant fuel savings.

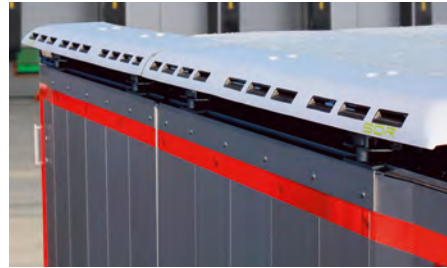

An optional spoiler fitted at the back of the trailer reduces the air turbulence behind the semi-trailer and this alone offers fuel savings of up to 3%.



A stanchion magazine for 8 stanchions is mounted on the chassis frame\* and provides storage for unused stanchions.



The fold-down tail lift\* ensures fast unloading even without a ramp or forklift.



Mounting\* for transportable forklift.



Pallet boxes\* provide storage for 24, 30 or 32 Euro pallets.

## Think Big!

### The S.CS MEGA and S.CS MEGA VARIOS – 100 m<sup>3</sup> Automotive Freight.

The S.CS MEGA sets the standard for automotive transport. The body is certified to DIN EN 12642 Code XL and enables you to transport 96 pallet cages or 34 Euro pallets. The Schmitz Cargobull Safety Roof as a standard feature can be raised on one side or both sides for stacker loading and can also be moved to the front or rear for crane loading.

The adjustable body with VARIOS TopTechnology allows the trailer to be coupled at different fifth wheel heights. The body with VARIOS TopTechnology enables the body to be adjusted to different fifth wheel heights with cargo area heights between 2,750 mm and 3,050 mm. The lower the fifth wheel height, the higher the usable cargo area height.

The S.CS MEGA VARIOS can be towed by both lowliner and standard tractors, thus offering you greater flexibility when scheduling your fleet.



The rear doors with adjustable body heights.



A perforated strip can be used to adjust the roof height in 50 mm steps.



Strong side: Pallet stop, aluminium support slats and reinforced stanchions.



## High-Level Success.

### S.CS MEGA with Variable Double-Decker System.

Use the complete volume of the S.CS MEGA with 67 pallet spaces on two levels. On the upper level, as many as 33 pallets can be stacked up to the 3 m high roof. The sliding roof can be opened to the front and the rear for crane loading. Removable diagonal struts in the roof provide the body with additional stability. The lifting roof is a standard feature and can be raised when loading the trailer from the side with a forklift.

Telescoping cross beams are simply attached to the I-beams at the right height for the second loading level. If necessary, lashing straps can also be securely attached to the I-beams.

The body is certified to DIN EN 12642 Code XL, so that no additional load securing is necessary when transporting interlocking complete loads.



Cross beams between the stanchions or side support beams allow the second level of freight to be securely loaded.



Two cross beams are provided for one pallet row in a grid of approx. 1,200 mm.



Efficient conveyor systems simultaneously load both levels from the loading ramp or from the ground.

## Heavy Coils Safely Transported.

### S.CS COIL Steel Transport—The Coil Well.

The S.CS COIL with its low centre of gravity enables the safe transport of steel coils with a diameter ranging from 800 mm to 2,200 mm. The reinforced frame construction is capable of handling point loads of up to 30 t on 1.5 m. With a Certificate of Exemption it is thus capable of transporting indivisible freight with a total towing weight of 45 t in a five-axle truck and trailer combination. The trough covers allow return freight such as pallets to be transported, thus increasing the trailer's efficiency.



The frame construction is capable of handling point loads of 30 t on 1.5 m. With a Certificate of Exemption it is thus capable of transporting indivisible freight with a total towing weight of 45 t in a five-axle truck and trailer combination.

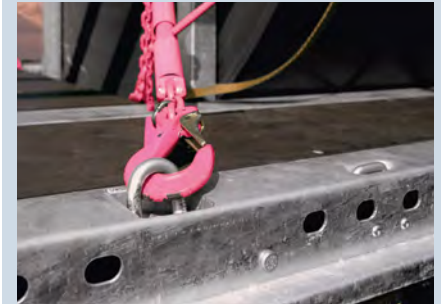

15 pairs of 5 t lashing rings in the outer frame enable the load to be secured at almost any point.



The trough covers allow return freight such as pallets to be transported, thus increasing the trailer's efficiency.



Certified body design fulfils the requirements of VDI 2700.

## Two Transport Solutions in One Vehicle.

### S.CS COIL – Coil Transport Equipment.

Because of the heavy loads involved in transporting steel, the S.CS COIL is equipped with a certified load securing concept as per VDI 2700 Sheet 19.

The S.CS COIL load securing concept is designed to handle heavy loads. That is why the COIL equipment on a Schmitz Cargobull trailer has been tested and certified by TÜV.

The combination of coil well and Joloda steel rails makes your daily transport tasks even more efficient. Steel coils on the outbound journey and paper rolls on the return journey.

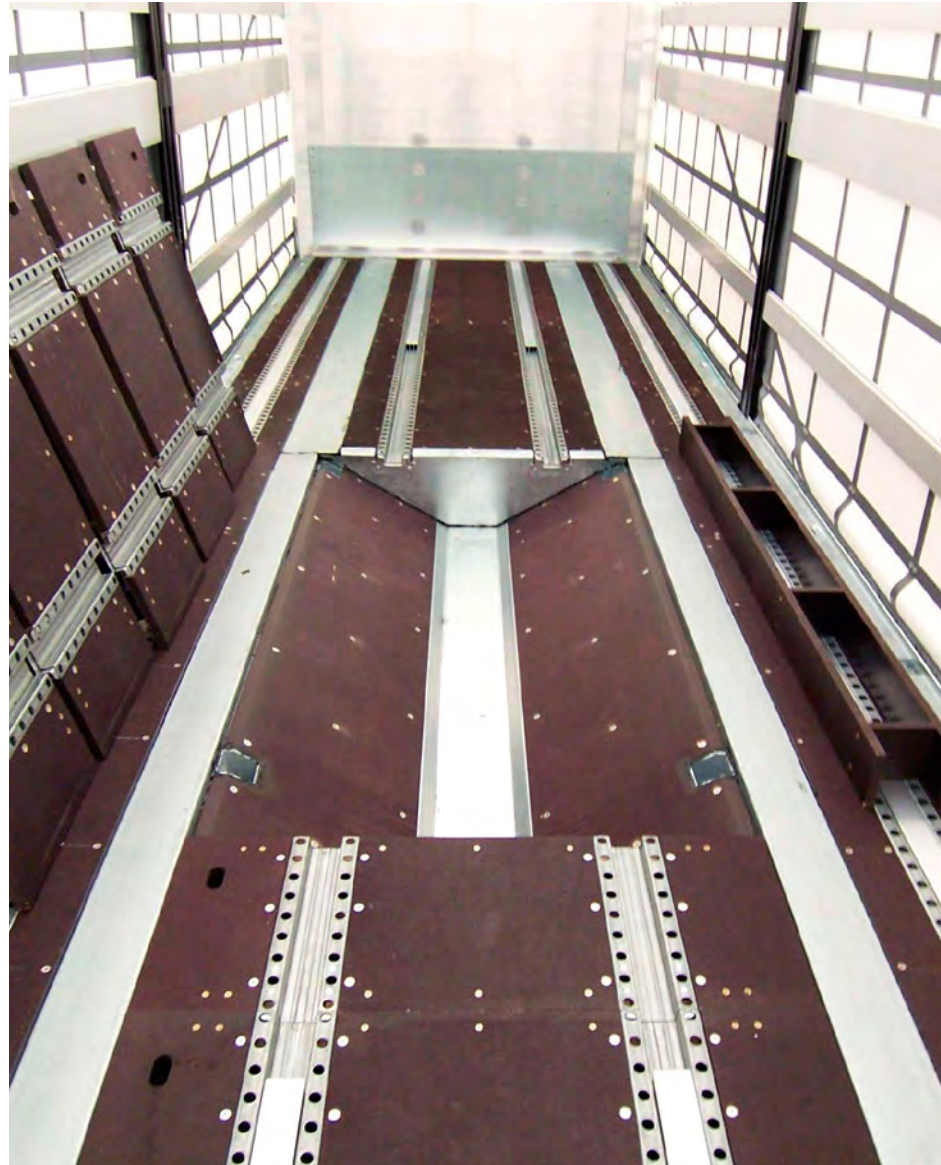

Two transport solutions in one vehicle. Steel coils on the outbound and paper rolls on the return journey.

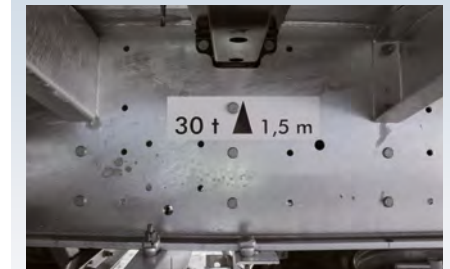
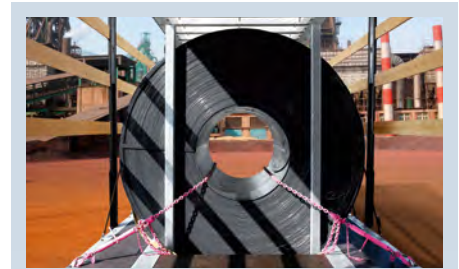

The load's centre of gravity is marked on the I-beam.

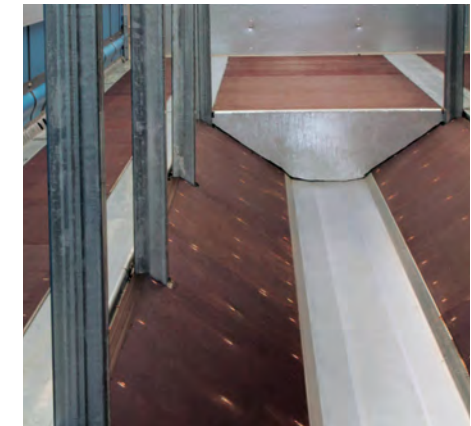

The coil combi-support simplifies load securing. It fits into the stanchion pockets in the wells – and also into the stanchion pockets on the outer frame.

## Our Quality is Documented and Certified.

S.CS PAPER – The Specialist for Paper Transport.

The S.CS PAPER is a multi-talented specialist. Its specially designed chassis with its narrow cross-beam spacing together with the sturdy plywood floor enable a maximum stacker axle load of 9 t (as per DIN EN 283). The entire construction offers your business certified safety, because the S.CS PAPER body strength has been tested and certified as per the VDI standard 2700 Sheet 9 for paper roll transport.



Certified load securing with a system. Whether lying longitudinally or laterally, lashed down or secured with locking wedges which can be used in 4 directions, or standing and secured using top lashing and additional anti-slip mats.

Optional chassis design for multi-modal transport.

## Easy Handling with Heavy Rolls.

### S.CS PAPER – Paper Logistics Equipment.

Paper does not only leave a trail, it is also heavy. Just the right job for the X-LIGHT version of the S.CS PAPER with perforated steel I-beams. Lashing rings along the entire length of the out of frame enable the load to be lashed vertically at almost any position. The Schmitz Cargobull S.CS PAPER fulfils the DIN EN 12642 Code XL along with the VDI Directive 2700 Sheet 9 and thus meets all of the requirements for paper transport.



An anti-slip mat between the paper roll and the wedge increases the friction, improving the load securing.



Full-length, wear-resistant, perforated steel Joloda rails in combination with Joloda rollers allow paper rolls and pellets to be moved manually on the loading surface.



The storage compartment in the bulkhead provides storage space for the Joloda accessory parts.

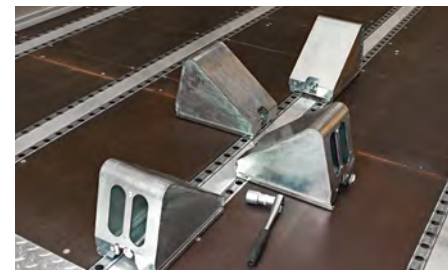

Every 5.5 kg wedge can be locked onto the perforated rail longitudinally and perpendicular to the driving direction.



Ripple plate at the rear mounted flush with the floor and the Joloda rails protects the floor when loading and unloading the vehicle via ramps.



## Built-In Efficiency for Beverage Logistics.

### Certified Load Securing for Beverage Transport.

Schmitz Cargobull trailers put you on the road faster. Because interlocking complete loads allow you to forego lashing down the beverage crates when transporting them with your S.CS curtainsider. Furthermore, the body, the roof beams and the corner and middle stanchions have also been reinforced. Four aluminium slats provide side support together with the side tarpaulin with longitudinal, lateral and diagonal reinforcing straps. Together with the flexible load securing system, the S.CS curtainsider from Schmitz Cargobull thus fulfils the DIN EN 12642 CODE XL standard with beverage certificate.



Transverse beams at the front and rear of the freight secure partial loads against sliding longitudinally.



Spacing slats are folded so that they interlock along the sides for the transportation of well pallets.



The cross beams can be positioned precisely using the flexible load securing system with a perforated grid in the steel support slats. They are inserted with two simple motions.

## Flexible with Liquid Loads.

S.CS Curtainsider Semi-trailer – Also Certified for Keg Transport.

Expand your transport business. Use your standard curtainsider trailer for transporting kegs as well. TÜV NORD has certified the curtainsider trailers made by Schmitz Cargobull as being able to transport kegs safely. The enhanced certification as per DIN EN 12642 CODE XL and the VDI Directive 2700, Sheet 12 authorises the transporting of 30/50 litre steel kegs that have been strapped onto a pallet to form a unit. This authorisation applies to all unstrapped, plastic coated kegs with 30 or 50 litre capacities.



The S.CS with SPEED CURTAIN not only accelerates the loading process, it also simplifies load securing thanks to the flexible load securing system.



The body's certified qualities enable transport without lashing down strapped steel kegs on pallets or unstrapped kegs with a plastic coating. Four aluminium support slats are always provided. Here combined with steel laths with holes for fitting the cross beams.

## Our Powerful Lightweights.

### The S.CS X-LIGHT Model Family: UNIVERSAL, MEGA, COIL, PAPER

The X-LIGHT vehicle family is distinguished by a weight reduction of up to 1,200 kg (for the MEGA) without having to accept any functional restrictions. The curtainsider semi-trailers are available as UNIVERSAL X-LIGHT and MEGA X-LIGHT in addition to the COIL and PAPER equipment variants and are highly functional thanks to the payload advantages and fuel savings while also offering optimal equipment for load securing. The X-LIGHT family is certified to DIN EN 12642 Code XL and an optional beverage certificate is also available.



The familiar models and diversity of Schmitz Cargobull curtainsiders is also available for the X-LIGHT versions without any restrictions.



The lightweight design of the X-LIGHT chassis consists of a combination of high-strength steel and aluminium, offering high loading capacity with low weight.



An aluminium drop (optional) support at the tail end of the vehicle provides extra stability during loading.

## Low Weight, Highly Practical.

The Equipment for the  
S.CS X-LIGHT Models.

The reduced weight of all X-LIGHT vehicles does not detract from their high practicality. Fewer parts, light materials and an adapted design are the secret.

Simply safe – The rapid roof lift. The rapid roof lift accelerates loading and unloading when using the complete interior height.

The manual lift system integrated into the corner stanchions provides high flexibility and reliability.

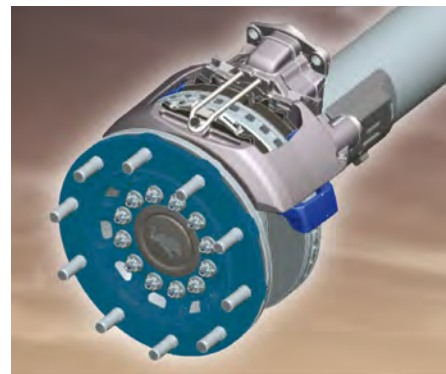

The ROTOS running gear with 19.5" brake discs: High performance despite a small diameter and low weight.



The drop supports made of extra-light aluminium.



The mechanical lifting equipment in the corner stanchions enables the roof on MEGA trailers to be raised manually.

## A Certificate to Build On.

The Structural Rigidity is Certified to DIN EN 12642 Code XL.

The strength and durability of our curtainsiders has been comprehensively and indisputably certified. The curtainsiders easily fulfil DIN EN 12642 (Code XL) and DL Directive 9.5 as well as the additional standards for train loading and beverage transport.

Completely interlocking loading with freight pallets, beverage pallets or pallet cages for the automotive industry require no additional load securing measures. The easily visible labels for all of the standards are displayed on the tarpaulin and specify which load securing standards the body meets. This guarantees high transport safety which is visible at first glance.



The new rear portal frame with the high-strength corner stanchions offers greater safety at the ramp.



High-strength, adjustable middle stanchions suitable for beverage transport. The two-point mounting on the roof beam simplifies handling.



The structural strength of the body is visibly displayed on the front bulkhead.

## This Roof Keeps Your Load Safe.

### Schmitz Cargobull Safety Roof.

All of the standard Schmitz Cargobull curtainsiders are always equipped with the self-supporting Safety Roof. It can simply be opened to the front and the rear for crane loading. The roof can be raised on the left side, the right side or on both sides with the optional manual lift for stacker loading from the side.



The Schmitz Cargobull Safety Roof is part of the FLEXOS body system and does not require any further reinforcement for load securing.



The manual lift system in the corner stanchions allows the roof to be lifted on the left, right or on both sides.

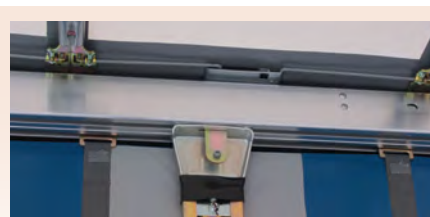

Standard cover with a 110 mm high roof beam.

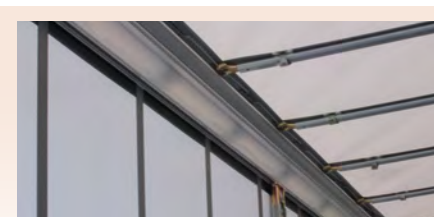

The 180 mm high roof beam on the MEGA cover enables pallet-width loading to beneath the roof.



### The Roof Safety Airbag (RSAB) supports traffic safety.

When pumped up, the RSAB simply causes water to run off the sides of the roof. In winter, the system prevents ice from forming on the roof and, thus, protects following traffic while driving.

## Lightning. Quick.

### SPEED CURTAIN – Access to the Freight in Moments.

Almost no other feature emphasises the economy and efficiency of a curtainsider semi-trailer more than the S.CS with the SPEED CURTAIN from Schmitz Cargobull. The side tarpaulin opens immediately in one movement to two thirds of the through-loading width without needing to remove the stanchions and supporting slats otherwise required. The innovation: vertical micro-stanchions are integrated into the tarpaulin. These provide the S.CS UNIVERSAL and S.CS MEGA with the SPEED CURTAIN with a body strength certified to DIN EN 12642 Code XL. In addition, they also fulfil the requirements of the DL Directive 9.5 and VDI Directive 2700 Sheet 12 for beverage transport.

The S.CS SPEED CURTAIN puts your vehicle back on the road faster. In times of just-in-sequence deliveries, you gain valuable minutes every time you load and unload the vehicle, giving you greater flexibility and efficiency for your fleet scheduling.



Use the efficiency benefits of the modular principle. We produce your DUO trailer with a SPEED CURTAIN for frequent loading and unloading on one side and the proven standard Schmitz Cargobull tarpaulin on the other side in order to meet your precise requirements.



A variety of load securing equipment, depending on the transport task, also allow the use of the sliding roof.



Secure partial loads with locking bars for palletised goods or pallet cages in the S.CS MEGA with SPEED CURTAIN.

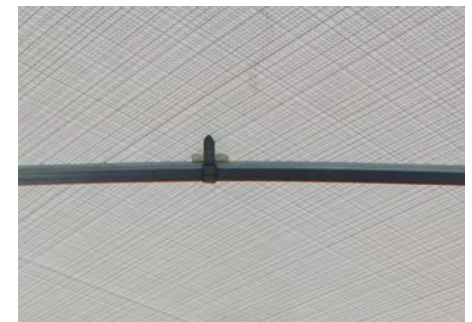

Optional for beverage transport: The Schmitz Cargobull Safety Roof with diagonally integrated plastic fibres stabilises the SPEED CURTAIN body.

## No Safety Compromises for Driver and Cargo.

**SPEED CURTAIN – Accident Prevention Integrated into the Tarpaulin.**

Thanks to the micro-stanchions integrated into the tarpaulin, no additional central stanchions and supporting slats are required for certified structural strength. There is no risk of injury caused by snapping locking levers on the stanchions and falling, loose parts. In addition, you also protect the driver as there is no longer any need to climb onto the loading surface to carry out additional load securing measures with complete loads.

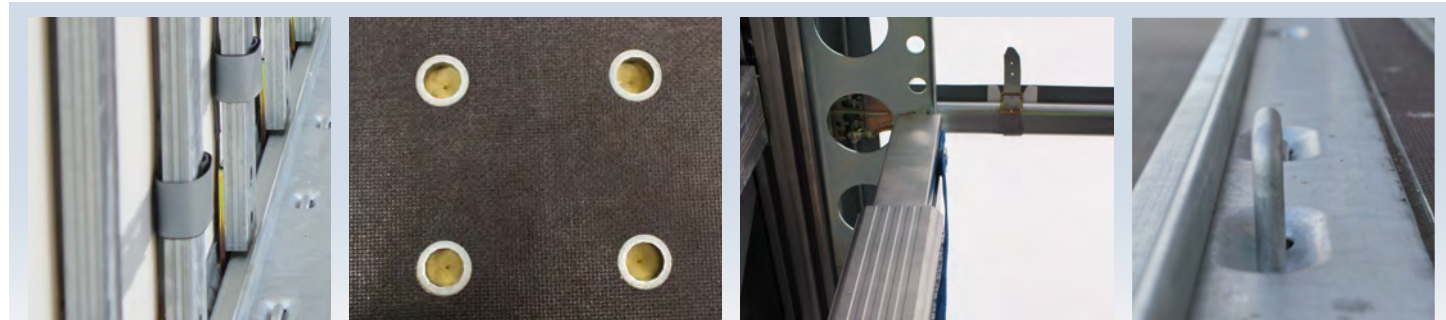
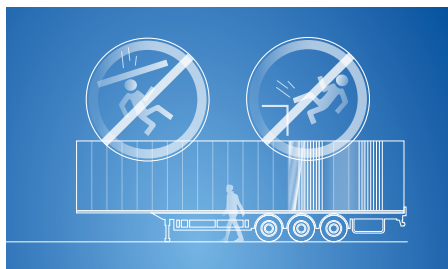

Partial loads can be secured using up to 30 pairs of lashing rings on the outer frame and, alternatively, locking sleeves in the floor and a perforated rail on the roof beam. Each of the lashing rings can be subjected to a load of up to 2 t. The pallet retaining bar secures pallets along the side.





## Loading Liquids.

### SPEED CURTAIN Vehicle with Tail Lift – The Ideal Partner for Beverage Logistics.

The combination of the SPEED CURTAIN body and a fixed tail lift at the rear bring together speed and high flexibility. The SPEED CURTAIN accelerates side loading at the ramp or with a stacker and saves valuable minutes especially for distribution transport involving frequent handling. The tail lift gives you independence at locations without extensive infrastructure.

The rapid and efficient load securing with locking bars and beams for rear load securing when transporting partial loads also offers an additional speed advantage.



The SPEED CURTAIN in combination with a fixed tail lift makes beverage transport extremely fast and flexible – whether long distance with complete loads or distribution transport.



Short support slats can also be used in between the load securing bars for securing the load in the beverage industry.



Four full-length perforated grid rails provide rapid securing of interlocking partial loads with locking bars.

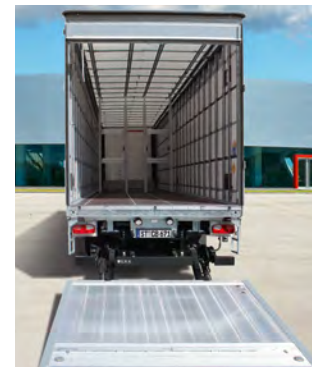

Robust aluminium, fixed-design tail lift with pendulum tailgate. Roll-off prevention for 2 roll containers and the separate side battery ensures safe work when loading and unloading.



## Welcome to the Club.

Transport Conformant with Daimler Load Securing Directive 9.5.

The Daimler Directive 9.5 sets the standards for freight transport in the automotive industry. This includes tarpaulin tensioners with mechanical locking to prevent unintentional opening, supporting slats made of aluminium or wood and other equipment details which are equipped on the S.CS MEGA in accordance with the directive. Talk to us about your freight transport tasks. We have the right transport solution.



Perfect load securing through steel laths with a tight grid.



Lashing rings along the outer frame and the bolted on pallet stop rails simplify the lashing down of the freight at virtually every point and the load can also be secured against moving sideways.



The raised roof enables efficient loading with pallet cages.

## Customs-Approved Curtainsiders.

Secure International Transport with TIR Equipment.

Use your opportunities throughout Europe. With an S.CS curtainsider with TIR configuration: A surrounding customs cable, a lead-sealed roof tarpaulin and solid covering plates over the tarpaulin clamping ratchets secure the load against lifting and partial opening. Upon request, the customs-approved curtainsider can also be equipped with side walls. In addition to the security aspects, this equipment also provides time benefits thanks to the rapid customs processing and faster loading.



The TIR curtainsider also allows the product benefits of the structural strength and rapid loading to be used in countries requiring TIR.



TIR-fixture with bonded load identification.



The roof is customs-secure thanks to the bulkhead covering.



Covering plates on the front and rear tarpaulin tensioners along with crimps on the outer frame ensure that the cargo is sealed for customs. All of the securing elements are connected with the full-length customs cable and the lead sealed.



## The S.CS Handles the Journey Alone.

### Combined Rail and Ferry Transport.

On some routes it is more efficient to transport the S.CS curtainsider alone by rail or ferry and deliver the freight via unaccompanied, multi-modal transport.

To ensure that neither the freight nor the vehicle suffer any damage in transit, the S.CS UNIVERSAL and the S.CS MEGA VARIOS are available with a robust standard frame for multi-mode transport. This provides the best protection for the vehicle and the freight. Because loading and unloading to and from train wagons or via terminal tractors for short-sea transport always takes place in tight spaces and under extreme time pressure.



The I-beam and frame feature special lashing points for ferry transport, allowing the vehicle to be secured to the ferry even in rough conditions.



Standardised gripper edges allow vertical handling using a crane or reach stacker.



The underride guard position enables compliance with the various enveloping spaces.



The required ILU code for inter-modal transport.

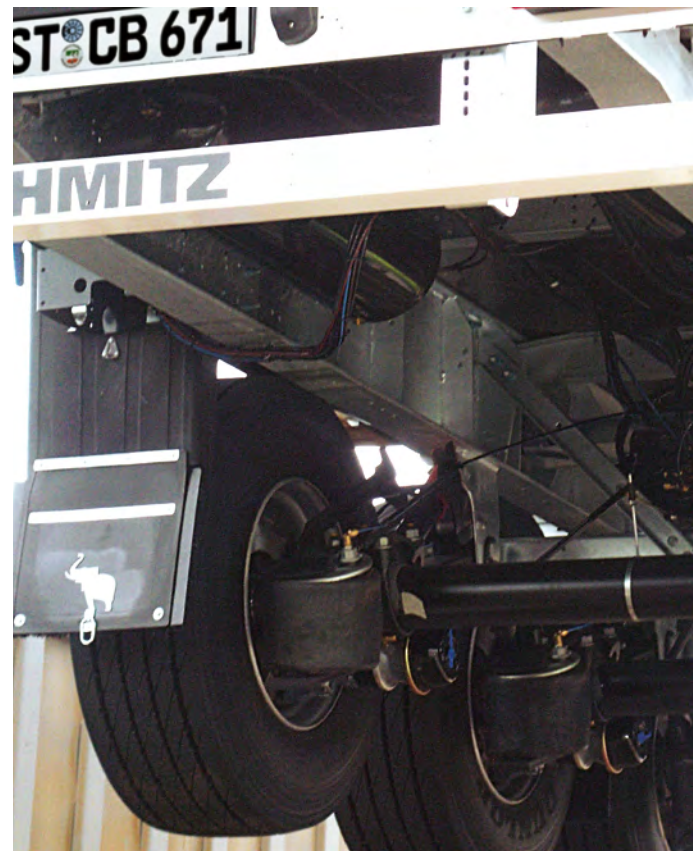

The pneumatic suspension with a splitter specially for vertical handling prevents damage to the bellows.



Reach stackers also enable vertical handling at railway facilities without portal cranes.

## Simply Safe.

### The S.PL Flatbed Trailer Reliably Transports Steel for the Construction Industry.

The S.PL flatbed trailer is the specialist for transporting reinforcement steel mesh and long material. It is distinguished by a solid design and specially flexible load securing. More than 70% of the reinforcing steel mesh transported does not exceed the width of 2,300 mm and can be transported without requiring additional equipment. Optionally, the vehicle is also capable of transporting over-wide loads of up to 3,200 mm.



S.PL flatbed semi-trailer for steel transport with special equipment for over-wide loads: Telescoping stanchion pockets, large storage box behind the running gear for stanchions and other lashing equipment. Four telescoping warning signs and a yellow flashing beacon at the rear provide a warning when transporting over-wide loads.



Four cross beams with telescoping stanchion pockets (up to 3,200 mm) can be fitted on the loading surface to transport over-wide reinforcing steel mesh (optional).

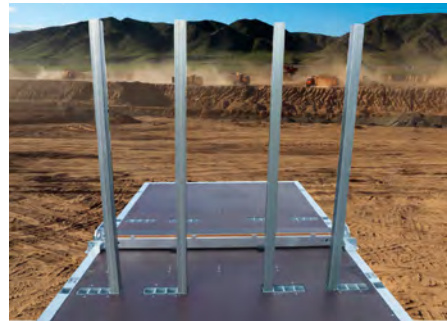

Flexible load securing for long material: eight rows of lateral stanchion pockets are mounted flush with the loading surface for fitting vertical stanchion supports.

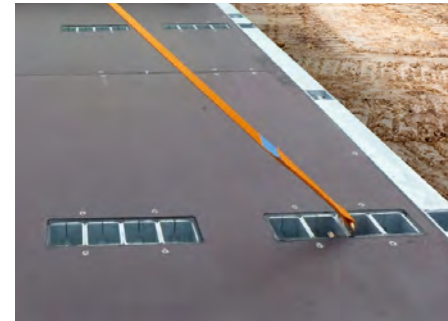

Every 4th stanchion pocket magazine contains rings for lashing using tensioning belts. In addition, 13 pairs of heavy-duty lashing rings for up to 5 t in the outer frame simplify load securing.



The low bulkhead and a short dropside round out the overall concept.

## The Universal Trailer for Building Materials Transport.

S.PR Bau – The Robust Carrier for the Construction Industry.

The S.PR Bau is the best choice for transporting building materials, construction machines and other all-weather freight. Reinforced I-beams and a floor capable of handling a stacker axle load of up to 8 t distinguish this robust workhorse. The S.PR Bau platform semi-trailer is available with a bulkhead, aluminium dropsides and a tail-gate as standard features. The platform semi-trailer can be rapidly transformed into a flatbed – thanks to 13 pairs of 2 t lashing rings and 10 pairs of 5 t lashing rings on the outer frame – and can even safely transport extra-wide freight with high point loads.



Alternatively, integrated container locks enable the transport of 20' or 40' ISO containers, for example.



Side walls can be stowed in a special pallet box.



For over-wide transport: extendable, illuminated warning sign on the side.



Removable side walls and stanchions enable easy conversion into a flatbed for transporting over-wide concrete slabs.

## The MODULOS Chassis.

### Innovative High-Tech Modular System for every Challenge.

The revolutionary roll formed I-beam is made of a single piece of material to enable the complete redesign of the MODULOS chassis. This provides greater performance strength thanks to greater distributed load with optimised weight and a very sturdy construction produced largely without welding – and thus without thermal deformation.



Both the static loads and, in particular, the dynamic forces arising when driving, loading and unloading with a forklift, for example, all put stress on the chassis. The strength reserves of the MODULOS chassis represent a particular advantage in this respect and have a direct effect on the profitability of your transport company.



The precise geometry of the running gear mounting has a positive influence on both the trailer's handling and also the tyre wear. The bolted connections guarantee a perfect fit and deformation-free assembly.



The construction of the MODULOS chassis using steel parts galvanised in advance provides perfect corrosion protection for years to come. Components can be specifically reinforced, allowing weight savings in other locations. The modular system enables a material mix with aluminium parts, for example, and specific customer requests can be implemented during production at short notice.



### New: Roll Forming not Welding.

The flexible roll forming process allows newly developed components to be manufactured precisely. The roller sets can swivel in all three dimensions to enable changes to be made to the cross section of the profile when roll forming. As well as improving the construction design, this innovative technology also helps to save energy and reduce harmful emissions.



## Quality from a Good Background.

Know-how and High-Tech Made in Germany.

The MODULOS chassis development and production is located in Altenberge – exactly where the complete curtainsiders are constructed. These are the perfect pre-requisites for synergies and harmonised solutions. The company invested in a new production facility specifically for this chassis. The 16 m long roller profiling system forms the heart of the production facility and manufactures various components out of one piece of material. This serves to seamlessly combine series production with customisation. Ultimately, our customers' requests and the market's needs are our most important driving factors.



Detachable bolted connections enable the cost-effective replacement of individual chassis components. In the process, the corrosion protection also remains intact.



MODULOS chassis, roller profiled I-beam without welding.



### **MODULOS: Bolting Technology and Corrosion Protection.**

Steel frame components are hot galvanised prior to assembly. Aluminium components are cathodic dip coated. Material contact points are also reliably protected against corrosion. We prove our quality standard with a 10 year warranty against rust-through. The bolted construction of the frame eliminates thermal stresses and ensures precise dimensions. Repairs can be carried out quickly and without damaging the corrosion protection by simply unscrewing the bolts and replacing the damaged parts. This creates premium quality, payload and weight-optimised frames. These frames withstand the demands and the dynamic stresses of general cargo transport for many years without any loss of structural integrity.





## Stay on Track. ROTOS DriveTechnology.

You demand a lot from our S.CS curtain-sider semi-trailers. That is why our ROTOS running gear is built for quality and only utilises high-quality, brand components from leading manufacturers as part of the concept. Your benefits: The perfect combination of axles, bearings, brakes, shock absorbers and pneumatic suspension.

The optional ROTOS self-steering axle provides the same quality and makes the trailer more manoeuvrable on winding routes. At the same time, tyre wear is reduced to a minimum and the mileage on the rear tyres is increased by up to 70 %. The Roll Stability Program (RSP) delivers the necessary tracking in critical situations and brakes individual wheels in order to restore the stability of the S.CS curtainsider semi-trailer.



The MRH pneumatic suspension with its auto-reset function is a standard feature – as are the large disc brakes and the maintenance-free hub units. Our seal of quality: 1,000,000 km warranty on the running gear\*.

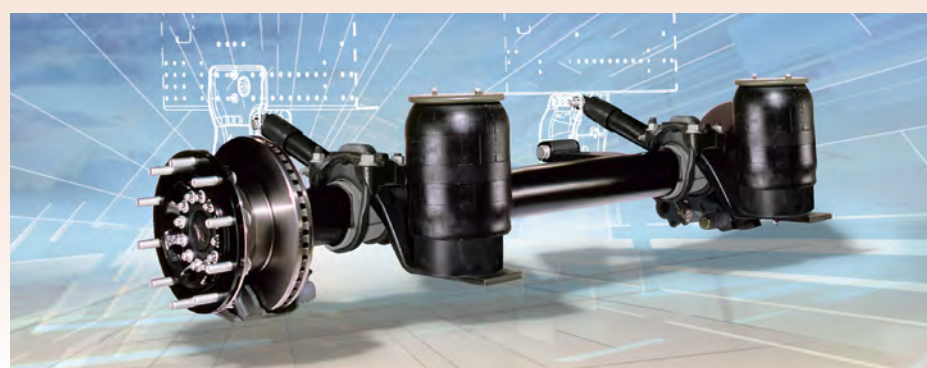

The ROTOS self-steering axle as a third axle increases the manoeuvrability on tight corners or when manoeuvring.

\* See the separate warranty conditions.

## The Intelligent Companion.

Clever Running Gear Steering – MRH, LSP, TIS with Immobiliser.

Schmitz Cargobull's Trailer Information System (TIS) with immobiliser, Load Spread Program (LSP) and TailGUARDlight™ distance measurement provide sophisticated solutions which support the driver, protect the freight and material, while also delivering vehicle management information.

The Multi Ride Height (MRH) air suspension is a standard feature and ensures optimal contact with the road and the right height for the loading ramp. The immobiliser is an anti-theft mechanism integrated into the brake assembly and is part of the TIS trailer information system. Other TIS functions include data about the axle load and mileage. The sensors mounted on the rear measure the distance and automatically initiate braking. The brake lining wear indicator is possible in combination with trailer telematics.

The TailGUARDlight™\* system provides greater safety when approaching the ramp. The sensors mounted on the rear measure the distance and automatically initiate braking, if desired.



The TIS trailer information system provides access to a broad range of information.



Ramp distance monitoring using the TailGUARDlight™\* sensors.

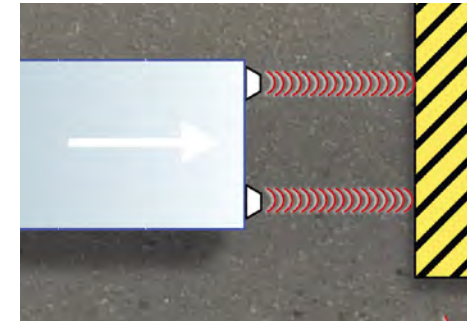

The wheel sensors transmit the air pressure to the tractor unit, the TIS trailer information system and the trailer telematics.



### LSP for Correct Loads.

The centre of gravity changes for partial loads at the rear; it moves forward and increases the trailer load. The shifting of the centre of gravity can be balanced out to avoid exceeding the permissible load on the driven axle of the tractor unit: The LSP (Load Spread Program) decreases the load on the rear axle.

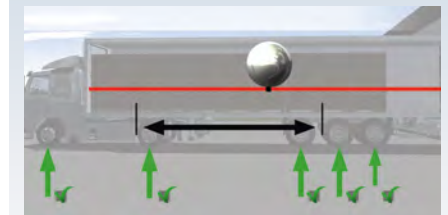

Lowering the pneumatic suspension pressure on the last axle shortens the effective wheelbase and restores the correct load distribution.

\* A registered trademark of WABCO Fahrzeugssysteme GmbH

## Control is Better.

### Trailer Telematics for the S.CS Curtainsider Semi-trailer.

Today, data-supported logistics is no longer simply an option, but rather a challenge which every forward-looking company has to face. Yet the issue is not whether truck or trailer telematics provide better information but rather how both services can effectively work together. Real-time data from your trailer affects your core business: The freight. Because your customers react sensitively and you need to retain control, especially when your trailer is travelling unaccompanied on a train or a ship as part of multi-modal transport.

Schmitz Cargobull trailer telematics is a tested system consisting of hardware, software and services. We ensure that your data is reliably and securely documented and is available at all times by integrating it into your carrier software or via a web service. There is no need for you to deal with any of the technical processes. This is part of our service – with the highest availability.



### This is what distinguishes the Schmitz Cargobull TrailerConnect solution:

- **Superb reliability** through high-quality hardware which meets automotive standards
- **Management by Exception** prevents data overload and only reports important events
- **Fixed costs thanks to a flat rate**, adapted to your individual transport solution
- **Autonomous functionality** through independent power supply for unaccompanied transport
- **Interfaces** ensure that you can connect to sub-systems or integrate into customer software
- **Standardised, universally usable industry solution** offering you security for the future
- **Automatic alarms** in real-time sent out via e-mail or text message

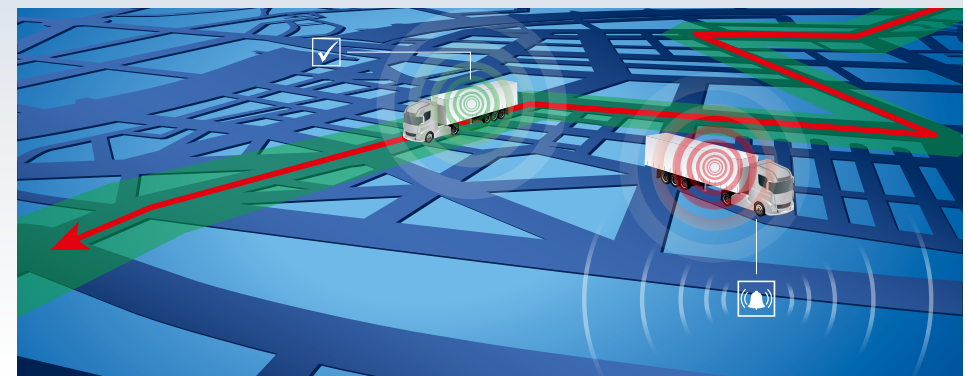

## An Eye on the Essentials.

### TrailerConnect for Your Fleet Management.

You need data which can be analysed in a fraction of a second in order to obtain an overview of your transport movements and the status of your trailers. This is exactly what TrailerConnect delivers. Intelligent analyses indicate whether the fleet is evenly utilised, which capacities are currently available, when trailers are forecast to arrive and how you can best organise maintenance and repair appointments. This is stress-free fleet management.

The telematics service, TrailerConnect Position, enables you to determine the current position and react immediately. TrailerConnect Info takes you one step further: This enables you to create a daily analysis of the use of your vehicles along with their current technical status.



#### TrailerConnect Position:

- Precise location data for your trailer via GPS
- Automatic status updates every 15 minutes or every three hours when parked
- Chronological, historical position documentation

#### TrailerConnect Info:

(including all of the functions of TrailerConnect Position)

- Information about entering and leaving defined areas through geo-fencing
- Trip data with documentation of driving and standstill times
- EBS data with alarm function for speed, mileage and axle loads
- Brake pad wear indicator
- Tyre pressure monitoring
- Depending on the vehicle equipment: event messages regarding ignition on/off, start/stop along with coupling activity

## We Are Happy to Help.

### Our Services for Your Vehicle.

The right service ensures that a good product becomes a perfect investment over the course of time. Working with your service providers should be just as simple as working with your curtainsiders.

Our one-stop service provides you with superior benefits. Your procurement process is much quicker if you have a one-stop shop for tailor-made financing, an inexpensive Full Service contract and integrated fitting with trailer telematics. In addition, you have one contact person who understands your needs, even in complex situations.

And who knows the product better than the manufacturer, who is therefore often in a better position to offer conditions for maintenance, repair and the residual value at the end than a third party can?

There are many good reasons for taking advantage of the comprehensive services provided by Schmitz Cargobull.



**Schmitz Cargobull Parts & Services** will deliver all available **original replacement parts** within 24 hours throughout Europe for most trailers. With a **Full Service contract** including **Breakdown Cover** you can insure yourself against the risk of repair and maintenance costs with an inexpensive single sum.

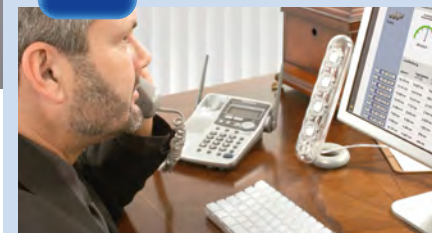

**Schmitz Cargobull Telematics** with **TrailerConnect** covers the increasing demands of modern **trailer telematics**. With the **Position** service you can simplify dispatch management, with the **Technology** service you implement requirement-oriented trailer maintenance. In addition, up-to-date reports provide you with the basis for more efficient **fleet management**.



**Schmitz Cargobull Finance** offers you tailor-made financing from the industry experts. Attractive conditions for **hire-purchase and leasing** or a **GAP Cover** are just as much a part of our range of services as the **Schmitz Cargobull insurance package**, which comprehensively covers many possible forms of damage.



To ensure that you are always quickly back on the road we have the **Cargobull Euroservice** 24 hours a day, 365 days a year in 40 European countries. With over **1,200 audited service partners**, a comprehensive European network ensures that you always receive professional help for your Schmitz Cargobull trailer.

## Just More.

Again and Again.

This will remain unchanged in the future. We know that we have to constantly regain our customers' trust. And that is why every day we strive to find the best solutions for you.

**Would you like more detailed information about our tarpaulin vehicles?  
Get in touch with us!**

Find out more at:  
[www.cargobull.com](http://www.cargobull.com)



### Schmitz Cargobull Sales Germany

**Cargobull Trailer Center Hamburg**  
Liebigstraße 103  
D-22113 Hamburg  
Tel.: +49 40 529872-0  
Fax: +49 40 529872-19  
E-Mail: [ctc.nord@cargobull.com](mailto:ctc.nord@cargobull.com)

**Cargobull Trailer Center Berlin**  
Robert-Guthmann-Str. 9  
D-15713 Königs Wusterhausen  
Tel.: +49 3375 5257979  
Fax: +49 3375 5257980  
E-Mail: [ctc.ost@cargobull.com](mailto:ctc.ost@cargobull.com)

**Cargobull Trailer Center Neuss**  
Welser Str. 8  
D-41468 Neuss-Uedesheim  
Tel.: +49 2131 12559-00  
Fax: +49 2131 12559-10  
E-Mail: [ctc.west@cargobull.com](mailto:ctc.west@cargobull.com)

**Cargobull Trailer Center Augsburg**  
Winterbrückenweg 27  
D-86316 Friedberg-Derching  
Tel.: +49 821 3434555  
Fax: +49 821 3434550  
E-Mail: [ctc.sued@cargobull.com](mailto:ctc.sued@cargobull.com)



**SCHMITZ**  
**CARGOBULL**   
The Trailer Company.



**Trailer** **Services** **Technology** *just more.*

Schmitz Cargobull AG · Bahnhofstraße 22 · D-48612 Horstmar · Germany  
Telephone +49 2558 81-0 · Fax +49 2558 81-500 · [www.cargobull.com](http://www.cargobull.com)

We reserve the right to make technical and design changes.  
S.CS-BRO-DE681-6477-3414