

INDESPÆNDT GLASVÆRN

Helglasværn indespændt i top- eller sidemonterede bundprofiler er en attraktiv designløsning til moderne byggeri. OnLevel værnsystemer består af slanke, men robuste aluminiumsprofiler, som anvendes både inden- og udendørs. Systemerne er optimeret for tidsbesparende montage, nem justering og høj personsikkerhed. Kataloget indeholder standardløsninger godkendt til 1,0 kN belastning og 12 - 21,52 mm glas. OnLevel tilbyder desuden løsninger til andre glastykkelser, højere belastningskrav og specielle montagesituationer. Spørg os efter specialkatalog.



NATURELOKSERET ALUMINIUM

Høj standard

Kernen i OnLevels omfattende sortiment er profiler i naturelokseret aluminium, godkendt til inden- og udendørs montage. Systemerne er løbende optimeret med udgangspunkt i mange års praktisk erfaring med montage og vedligeholdelse af værnssystemer.



RUSTFRIT STÅL-LOOK

Eksklusivt design

Værnprofil med rustfrit stål-look er en stilfuld løsning til f.eks. værn med håndlister i rustfrit stål. Du får fordelene af aluminiums lave vægt, høje styrke og konkurrencedygtige pris kombineret med et udseende som rustfrit stål.

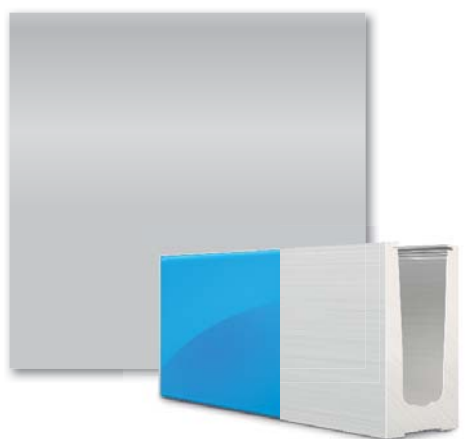

PULVERLAKERET VALGFRI FARVE

Rå aluminium eller valgfri pulverlakering

En spændende udvidelse af designmulighederne, med profiler i enhver ønsket farve. Den rå profilserie er velegnet til pulverlakering efter eget farvevalg. Du kan selvfølgelig også bestille rå profiler til indbygning, som de er.



Fleksibelt farvevalg til dit projekt

Værnprofilerne kan leveres i farve og finish helt efter dit ønske, eksempelvis din specifikke logofarve eller en elegant farvekode, som matcher projektets øvrige bygningsdele eller interiør. Spørg os til råds.

SORTIMENT

SYSTEMER GODKENDT FOR
1,0 kN BELASTNING,
GLASTYKKELSE 12 - 21,52 MM

ONLEVEL

3010-3011

MONTERET
I FLANGE

ONLEVEL

6010-6011

MONTERET
DIREKTE

Model 3010 1,0 kN
Topmonteret i flange



6

Model 3011 1,0 kN
Sidemonteret i flange



10

Model 6010 1,0 kN
Topmonteret direkte



14

Model 6011 1,0 kN
Sidemonteret direkte



18

TopCover
Tilpasningsprofil

23

Flex-Fit
Montagetilbehør og værktøj

25

Håndlister og tilbehør

28

MANGE ÅRS ERFARING MED HELGLASVÆRN

OnLevel værnprofilsystemer udvikles og produceres af specialister, som har mange års praktisk erfaring med montage af helglasværn. De kender myndigheders, fagfolks og bygherrers krav til designrigtige, montagevenlige og sikre glasinstallationer.

Erfaringer fra udfordrende internationale projekter indarbejdes løbende i designprocessen, så udvalget af innovative systemer og tidsbesparende montageløsninger tilpasses og udvikles.

Glasværn til alle behov

Rammeløse indespændte helglasværn er på få år blevet bredt benyttet i byggeri.



Det minimalistiske udtryk er æstetisk velegnet til boliger, kontorer og institutioner – nybyggeri som renovering. OnLevel tilbyder værnssystemer til alle belastningskrav og montagesituationer indendørs og udendørs.

Teknisk backup og rådgivning

OnLevel værnssystemer er behørigt testet og godkendt af institutter og myndigheder i hele Europa. Vi stiller dokumentation til rådighed sammen med eksempelvis CAD-tegninger og BIM-objekter.

Kontakt os for yderligere oplysninger eller en dialog om dit projekt.



NATURELOKSERET
ALUMINIUM



RUSTFRIT
STÅL-LOOK



PULVERLAKERET
ALU-PROFIL

ONLEVEL

3010-3011

MONTERET
I FLANGE

ELEGANT UDSEENDE,
MINIMAL VEDLIGEHOELSE

ONLEVEL

3010

TOP
MONTERET
I FLANGE



Model 3010

1,0 kN topmonteret i flange

- Slankt, attraktivt design med minimal vedligeholdelse
- OnLevel Flex-Fit glasmonteringsystem (side 24-25)
- Integreerede drænhuller
- TopCover tilpasningsprofil (side 23)
- Leveres også til 3,0 kN belastning

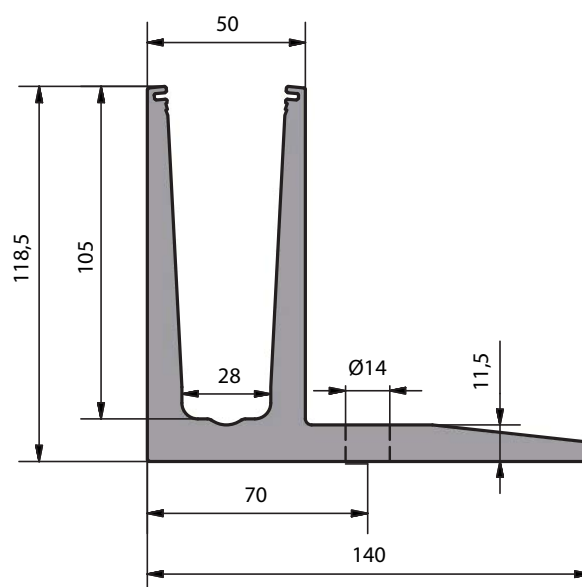
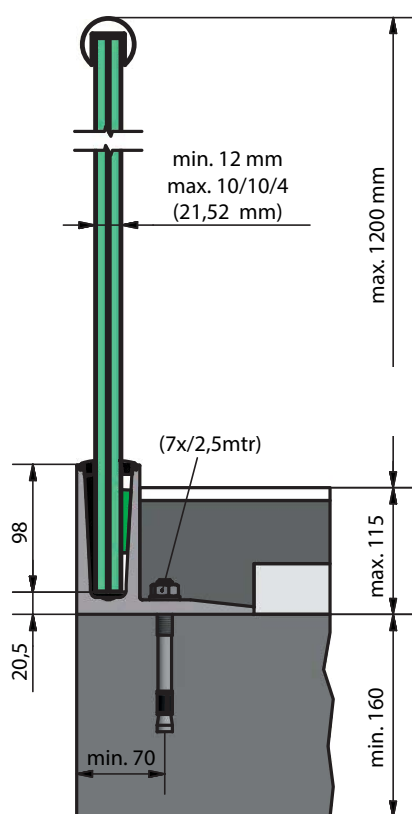

ONLEVEL 3010 | 1,0 KN TOPMONTERET I FLANGE

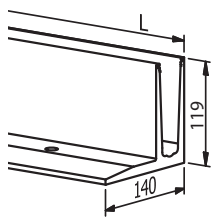

VÆRNPROFIL						
MODEL: 3010	RÅ ALUMINIUM	UDENDØRS	NATURELOKSERET	UDENDØRS	RUSTFRIT STÅL-LOOK	UDENDØRS
Længde	Art. nr.		Art. nr.		Art. nr.	
2.500 mm	-	-	135.3T2.101	1	-	-
5.000 mm	135.3T5.100	1	135.3T5.101	1	135.3T5.102	1
MODEL: 3010	PULVERLAKERET	UDENDØRS				
Længde	Art. nr.					
5.000 mm	135.3T5.103	1				

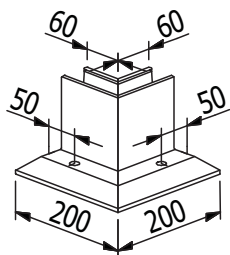

INDVENDIGT HJØRNE						
MODEL: 3010	RÅ ALUMINIUM	UDENDØRS	NATURELOKSERET	UDENDØRS	RUSTFRIT STÅL-LOOK	UDENDØRS
Indvendigt hjørne	Art. nr.		Art. nr.		Art. nr.	
Indvendigt hjørne	135.3TI.100	1	135.3TI.101	1	135.3TI.102	1
MODEL: 3010	PULVERLAKERET	UDENDØRS				
Indvendigt hjørne	Art. nr.					
Indvendigt hjørne	135.3TI.103	1				

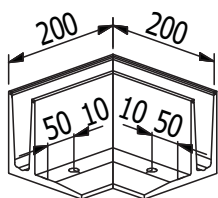

UDVENDIGT HJØRNE						
MODEL: 3010	RÅ ALUMINIUM	UDENDØRS	NATURELOKSERET	UDENDØRS	RUSTFRIT STÅL-LOOK	UDENDØRS
Udvendigt hjørne	Art. nr.		Art. nr.		Art. nr.	
Udvendigt hjørne	135.3TU.100	1	135.3TU.101	1	135.3TU.102	1
MODEL: 3010	PULVERLAKERET	UDENDØRS				
Udvendigt hjørne	Art. nr.					
Udvendigt hjørne	135.3TU.103	1				

ONLEVEL 3010 | 1,0 KN TOPMONTERET I FLANGE

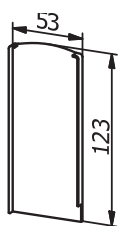

ENDEBUND						
MODEL: 3010	RÅ ALUMINIUM	UDENDØRS	NATURELOKSERET	UDENDØRS	RUSTFRIT STÅL-LOOK	UDENDØRS
Side	Art. nr.		Art. nr.		Art. nr.	
Venstre	135.3TL.100	1	135.3TL.101	1	135.3TL.102	1
Højre	135.3TR.100	1	135.3TR.101	1	135.3TR.102	1
MODEL: 3010	PULVERLAKERET	UDENDØRS				
Side	Art. nr.					
Venstre	135.3TL.103	1				
Højre	135.3TR.103	1				

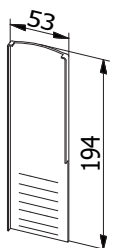

ENDEBUND TRAPPE						
MODEL: 3010	RÅ ALUMINIUM	UDENDØRS	NATURELOKSERET	UDENDØRS	RUSTFRIT STÅL-LOOK	UDENDØRS
Side	Art. nr.		Art. nr.		Art. nr.	
Venstre	135.3TL.1T0	1	135.3TL.1T1	1	135.3TL.1T2	1
Højre	135.3TR.1T0	1	135.3TR.1T1	1	135.3TR.1T2	1
MODEL: 3010	PULVERLAKERET	UDENDØRS				
Side	Art. nr.					
Venstre	135.3TL.1T3	1				
Højre	135.3TR.1T3	1				

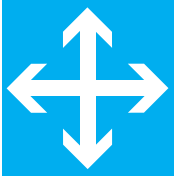

Montagebeslag

Sikker, fleksibel og tidsbesparende montage med OnLevel montagebeslag. Det kan være en udfordring at bore huller for befæstigelse helt præcist i underkonstruktionen. OnLevels flangeprofil er derfor forsynet med riller, som giver +/- 5 mm justeringsmulighed både lodret og vandret, når det anvendes sammen med montagebeslaget, som har tilsvarende riller. En detalje, som har stor praktisk betydning. Se montagevejledningen for yderligere information.

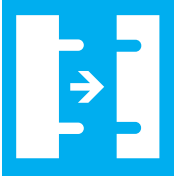
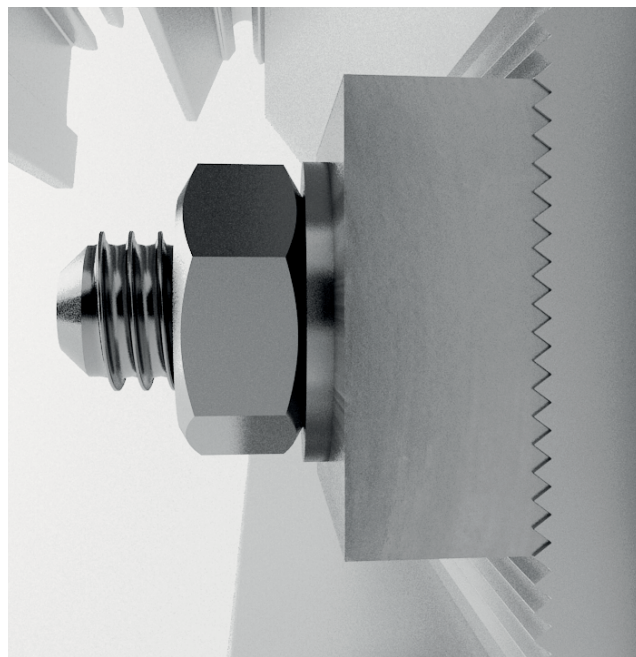
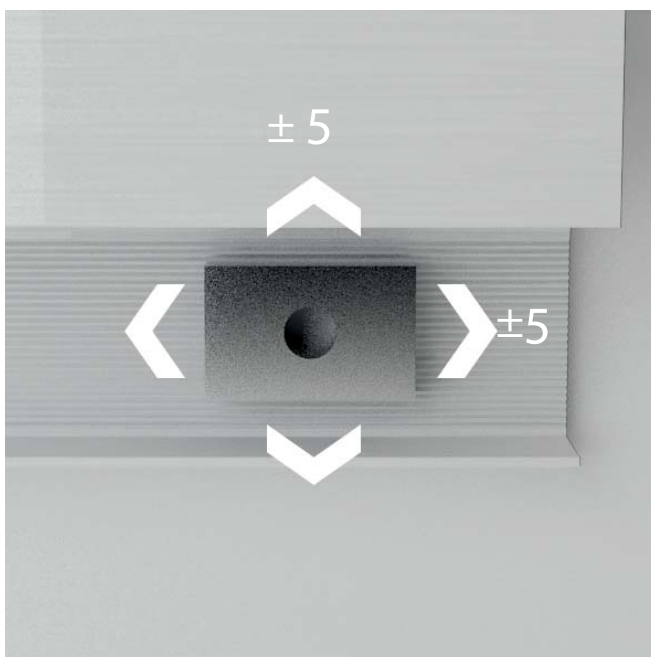

Samlepind

Samling af profiler til lange sektioner uden ekstra bearbejdning eller brug af specialværktøj. Samlepinde skal blot slås i de passende profiler (se symbolet). Fremstillet af syrefast rustfrit stål for anvendelse med inden- og udendørs profiler. Varenr. 135.PIN.000.

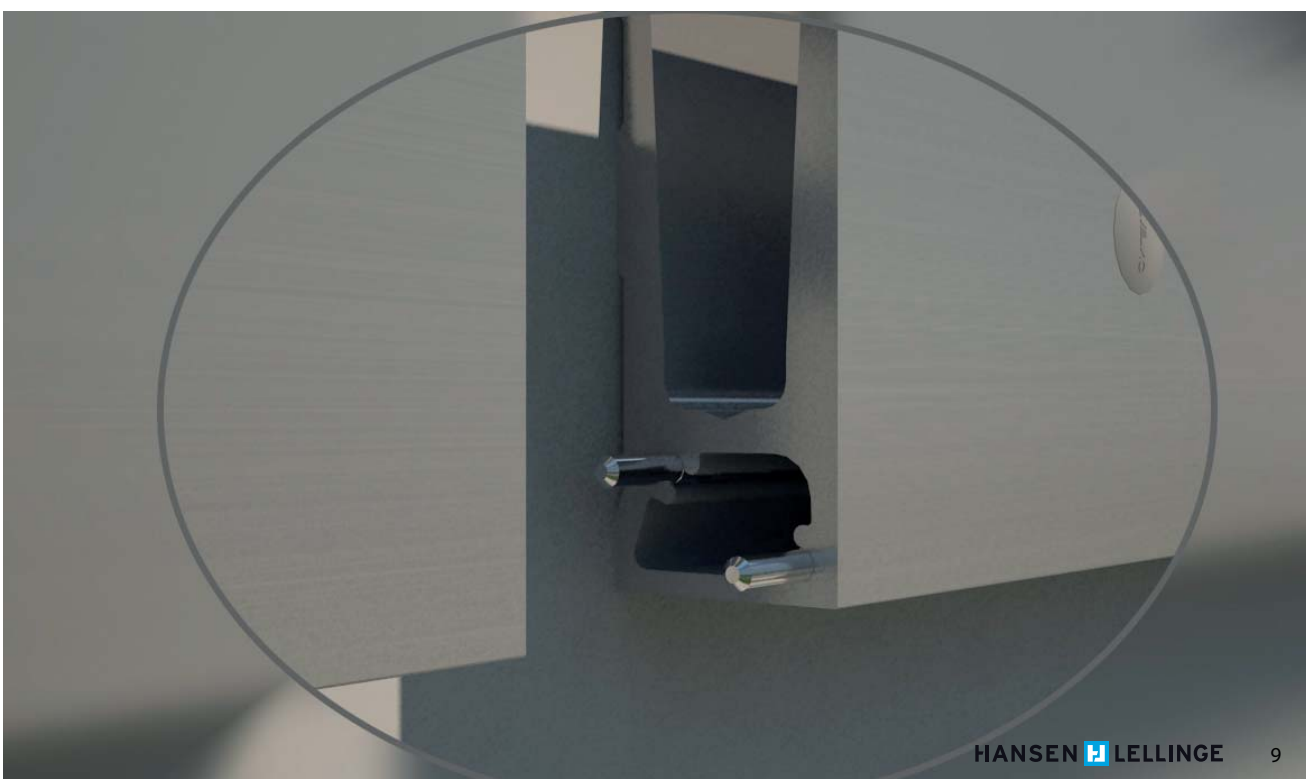

ONLEVEL

3011

SIDE
MONTERET
I FLANGE

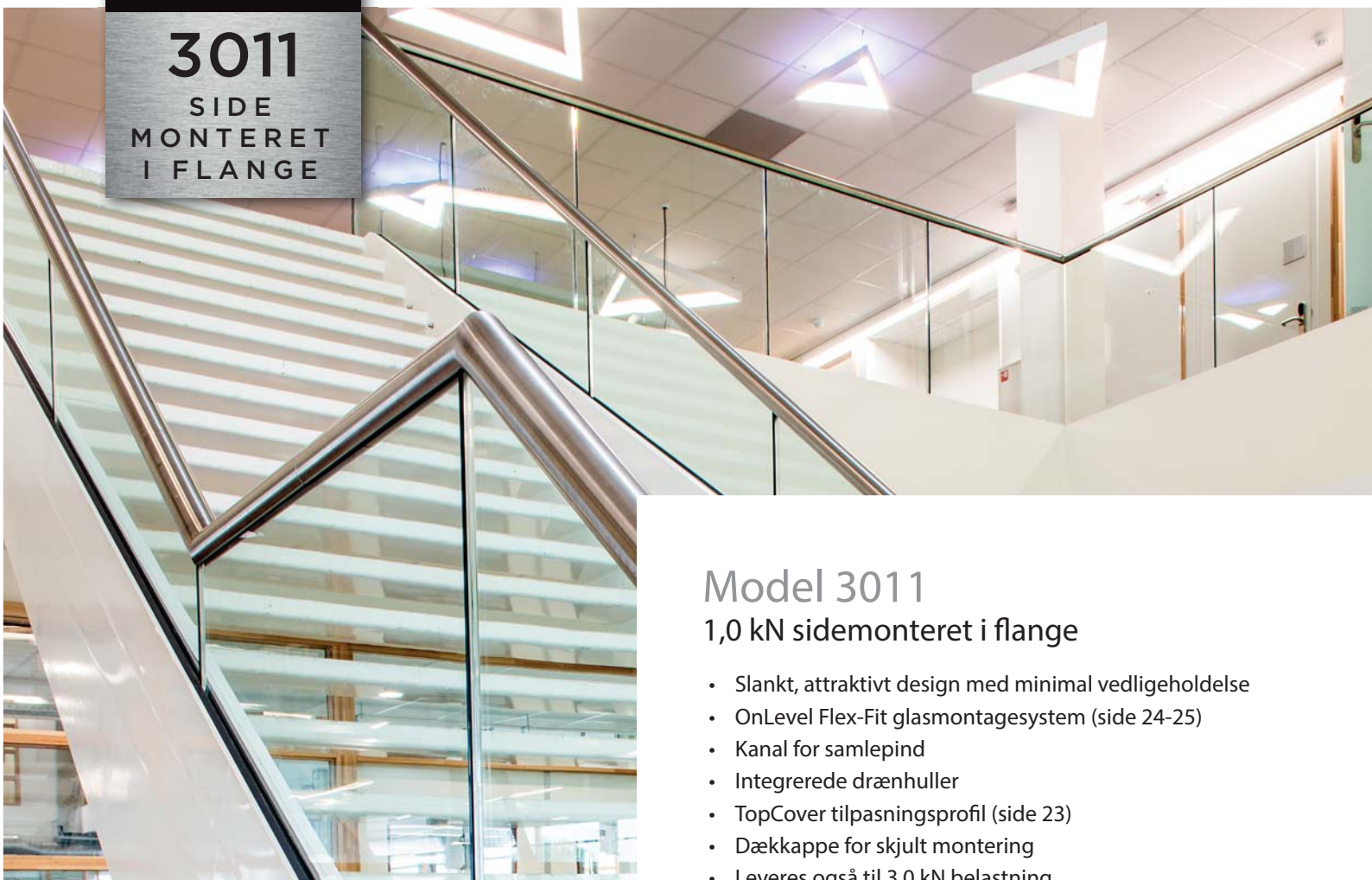

Model 3011

1,0 kN sidemonteret i flange

- Slankt, attraktivt design med minimal vedligeholdelse
- OnLevel Flex-Fit glasmontagesystem (side 24-25)
- Kanal for samlepind
- Integrerede drænhuller
- TopCover tilpasningsprofil (side 23)
- Dækkappe for skjult montering
- Leveres også til 3,0 kN belastning

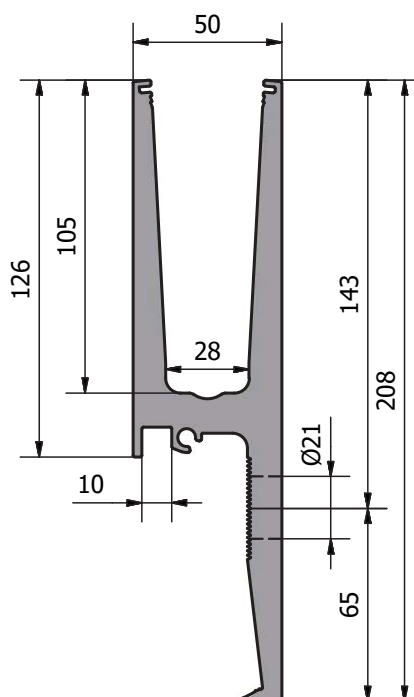
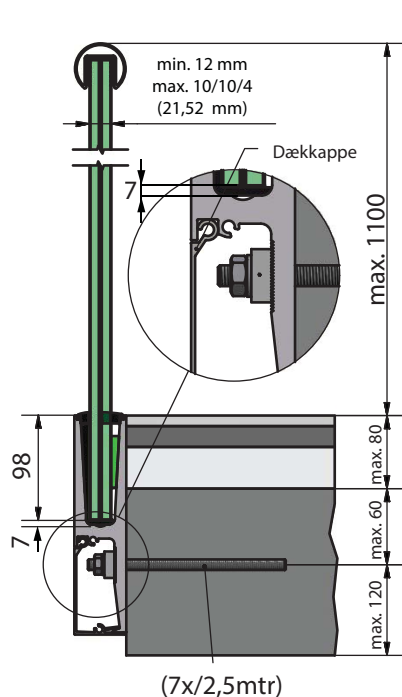

ONLEVEL 3011 | 1,0 KN SIDEMONTERET I FLANGE

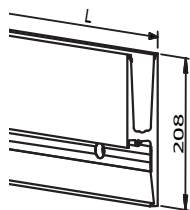

▼ VÆRNPROFIL

MODEL: 3011	RÅ ALUMINIUM	UDENDØRS	NATURELOKSERET	UDENDØRS	RUSTFRIT STÅL-LOOK	UDENDØRS
Længde	Art. nr.		Art. nr.		Art. nr.	
2.500 mm	-	-	135.3S2.101	1	-	-
5.000 mm	135.3S5.100	1	135.3S5.101	1	135.3S5.102	1
MODEL: 3011	PULVERLAKERET	UDENDØRS				
Længde	Art. nr.					
5.000 mm	135.3S5.103	1				

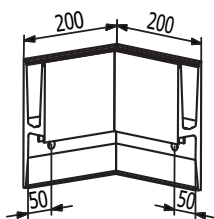

▼ INDVENDIGT HJØRNE

MODEL: 3011	RÅ ALUMINIUM	UDENDØRS	NATURELOKSERET	UDENDØRS	RUSTFRIT STÅL-LOOK	UDENDØRS
	Art. nr.		Art. nr.		Art. nr.	
Indvendigt hjørne	135.3SI.100	1	135.3SI.101	1	135.3SI.102	1
MODEL: 3011	PULVERLAKERET	UDENDØRS				
	Art. nr.					
Indvendigt hjørne	135.3SI.103	1				

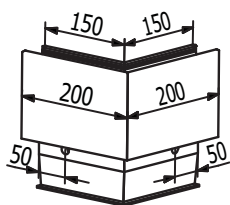

▼ UDVENDIGT HJØRNE

MODEL: 3011	RÅ ALUMINIUM	UDENDØRS	NATURELOKSERET	UDENDØRS	RUSTFRIT STÅL-LOOK	UDENDØRS
	Art. nr.		Art. nr.		Art. nr.	
Udvendigt hjørne	135.3SU.100	1	135.3SU.101	1	135.3SU.002	1
MODEL: 3011	PULVERLAKERET	UDENDØRS				
	Art. nr.					
Udvendigt hjørne	135.3SU.103	1				

ONLEVEL 3011 | 1,0 KN SIDEMONTERET I FLANGE

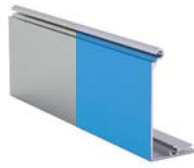
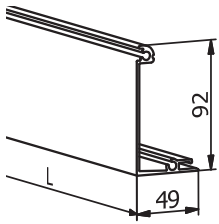

DÆKKAPPE						
MODEL: 3011	RÅ ALUMINIUM	UDENDØRS	NATURELOKSERET	UDENDØRS	RUSTFRIT STÅL-LOOK	UDENDØRS
Længde	Art. nr.		Art. nr.		Art. nr.	
2.500 mm	-	-	135.3C2.101	1	-	-
5.000 mm	135.3C5.100	1	135.3C5.101	1	135.3C5.102	1
MODEL: 3011	PULVERLAKERET	UDENDØRS				
Længde	Art. nr.					
5.000 mm	135.3C5.103	1				



ENDEBUND						
MODEL: 3011	RÅ ALUMINIUM	UDENDØRS	NATURELOKSERET	UDENDØRS	RUSTFRIT STÅL-LOOK	UDENDØRS
Side	Art. nr.		Art. nr.		Art. nr.	
Venstre	135.3SL.100	1	135.3SL.101	1	135.3SL.102	1
Højre	135.3SR.100	1	135.3SR.101	1	135.3SR.102	1
MODEL: 3011	PULVERLAKERET	UDENDØRS				
Side	Art. nr.					
Venstre	135.3SL.103	1				
Højre	135.3SR.103	1				



ENDEBUND TRAPPE						
MODEL: 3011	RÅ ALUMINIUM	UDENDØRS	NATURELOKSERET	UDENDØRS	RUSTFRIT STÅL-LOOK	UDENDØRS
Side	Art. nr.		Art. nr.		Art. nr.	
Venstre	135.3SL.1T0	1	135.3SL.1T1	1	135.3SL.1T2	1
Højre	135.3SR.1T0	1	135.3SR.1T1	1	135.3SR.1T2	1
MODEL: 3011	PULVERLAKERET	UDENDØRS				
Side	Art. nr.					
Venstre	135.3SL.1T3	1				
Højre	135.3SR.1T3	1				

ONLEVEL

6010-6011

MONTERET
DIREKTE

MODERNE DESIGN
I DET LOOK, DU ØNSKER



ONLEVEL

TL-60

BASIS
MODEL



Model 6010

1,0 kN topmonteret direkte

- Slankt, attraktivt design med minimal vedligeholdelse
- OnLevel Flex-Fit glasmonteringsystem (side 24-25)
- Integreerede drænhuller
- TopCover tilpasningsprofil (side 23)
- Leveres også til 3,0 kN belastning

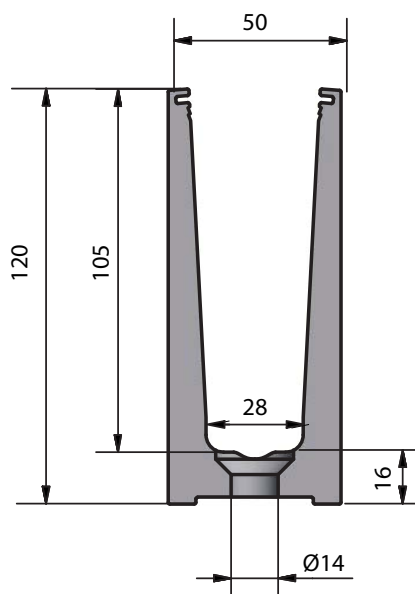
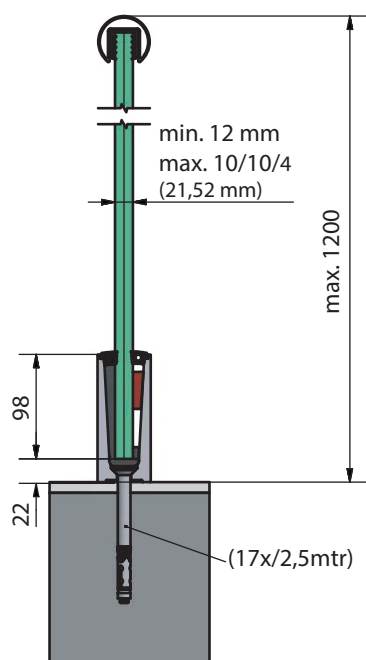

ONLEVEL 6010 | 1,0 KN TOPMONTERET DIREKTE

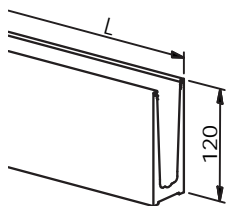

VÆRNPROFIL

MODEL: 6010	RÅ ALUMINIUM	UDENDØRS	NATURELOKSERET	UDENDØRS	RUSTFRIT STÅL-LOOK	UDENDØRS
Længde	Art. nr.		Art. nr.		Art. nr.	
2.500 mm	-	-	135.6T2.101	1	-	-
5.000 mm	135.6T5.100	1	135.6T5.101	1	135.6T5.102	1
MODEL: 6010	PULVERLAKERET	UDENDØRS				
Længde	Art. nr.					
5.000 mm	135.6T5.103	1				

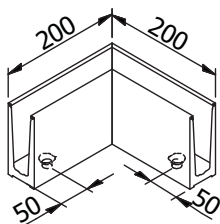

INDVENDIGT / UDVENDIGT HJØRNE

MODEL: 6010	RÅ ALUMINIUM	UDENDØRS	NATURELOKSERET	UDENDØRS	RUSTFRIT STÅL-LOOK	UDENDØRS
	Art. nr.		Art. nr.		Art. nr.	
Ind- / Udvendt	135.6TH.100	1	135.6TH.101	1	135.6TH.102	1
MODEL: 6010	PULVERLAKERET	UDENDØRS				
	Art. nr.					
Ind- / Udvendt	135.6TH.103	1				

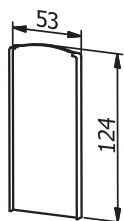

ENDEBUND FOR VENSTRE / HØJRE

MODEL: 6010	RÅ ALUMINIUM	UDENDØRS	NATURELOKSERET	UDENDØRS	RUSTFRIT STÅL-LOOK	UDENDØRS
	Art. nr.		Art. nr.		Art. nr.	
Venstre / Højre	135.6TE.100	1	135.6TE.101	1	135.6TE.102	1
MODEL: 6010	PULVERLAKERET	UDENDØRS				
	Art. nr.					
Venstre / Højre	135.6TE.103	1				

ONLEVEL 6010 | 1,0 KN TOPMONTERET DIREKTE

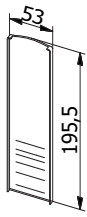

ENDEBUND TRAPPE FOR VENSTRE / HØJRE						
MODEL: 6010	RÅ ALUMINIUM	UDENDØRS	NATURELOKERET	UDENDØRS	RUSTFRIT STÅL-LOOK	UDENDØRS
Side	Art. nr.		Art. nr.		Art. nr.	
Venstre / Højre	135.6TT.100	1	135.6TT.101	1	135.6TT.102	1
MODEL: 6010	PULVERLAKERET	UDENDØRS				
Side	Art. nr.					
Venstre / Højre	135.6TT.103	1				

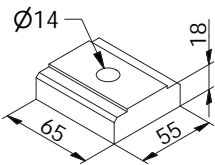

AFSTANDSKLODS		
MODEL: 6010	NATURELOKERET	UDENDØRS
Art. nr.	pr. 2.500 mm	
135.6TA.101	17 stk.	17

ONLEVEL

3010-3011
 MONTERET
 I FLANGE

ONLEVEL

6010-6011
 MONTERET
 DIREKTE

ENDEBUND TIL TRAPPER TILPASSES EFTER BEHOV

OnLevel har udviklet nye endebunde til trapper, som nemt kan tilpasses efter behov. Ved at bruge markeringen af grader på bagsiden af endebunden, kan du nemt tilpasse endebunden til den ønskede vinkel.

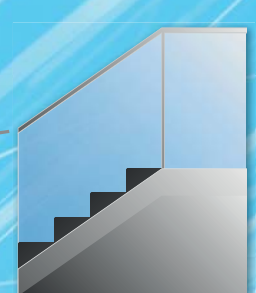
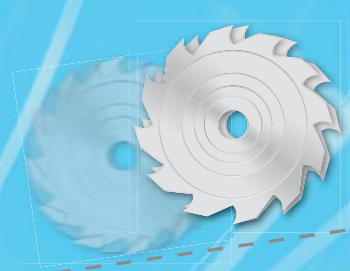
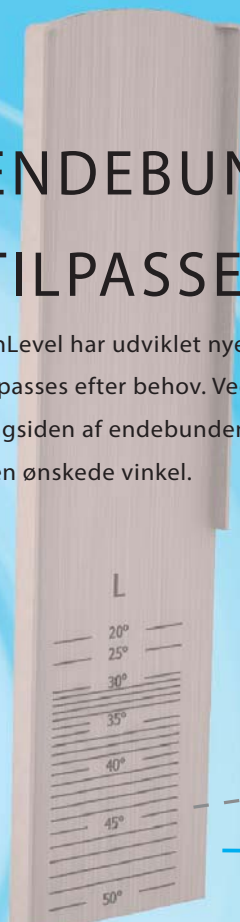

KAN TILPASSES



Drænhuller

OnLevel værnprofiler er forsynet med drænhuller for hver meter, for at forebygge problemer med vand i profilerne, som fryser til om vinteren.



Færre montagepunkter

OnLevel lægger stor vægt på sikkerhed, design og kvalitet ved udvikling af værnløsninger. Men også omkostninger til montage tænkes ind i konstruktionen, og her spiller antallet af nødvendige befæstigelse en stor rolle. Hver forankring, som kan undværes, sparer materialeomkostninger og tidsforbrug ved montagen, dette må naturligvis ikke gå ud over stabiliteten. OnLevels ingeniører har udviklet en integreret vridningsstabil konstruktion, som giver længere afstand mellem befæstigelse uden at gå på kompromis med sikkerheden.



ONLEVEL

6011

SIDE
MONTERET
DIREKTE



Model 6011

1,0 kN sidemonteret direkte

- Slankt, attraktivt design med minimal vedligeholdelse
- OnLevel Flex-Fit glasmonteringsystem (side 24-25)
- Kanaler for samlepind
- Integrerede drænhuller
- TopCover tilpasningsprofil (side 23)
- Dækkappe for skjult montering
- Leveres også til 3,0 kN belastning

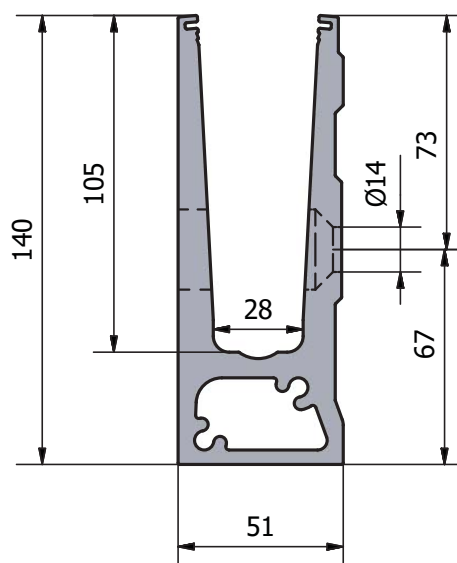
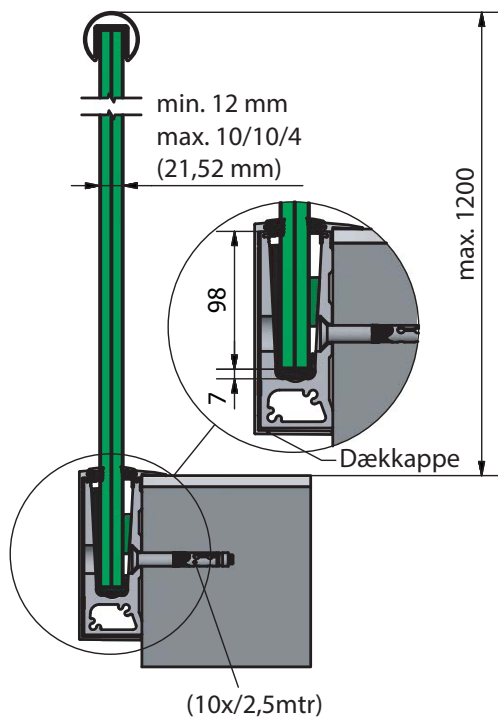

ONLEVEL 6011 | 1,0 KN SIDEMONTERET DIREKTE

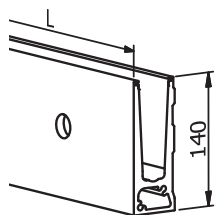

▼ VÆRNPROFIL

MODEL: 6011	RÅ ALUMINIUM	UDENDØRS	NATURELOKSERET	UDENDØRS	RUSTFRIT STÅL-LOOK	UDENDØRS
Længde	Art. nr.		Art. nr.		Art. nr.	
2.500 mm	-	-	135.6S2.101	1	-	-
5.000 mm	135.6S5.100	1	135.6S5.101	1	135.6S5.102	1
MODEL: 6011	PULVERLAKERET	UDENDØRS				
Længde	Art. nr.					
5.000 mm	135.6S5.103	1				

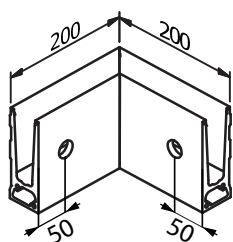

▼ INDVENDIGT HJØRNE

MODEL: 6011	RÅ ALUMINIUM	UDENDØRS	NATURELOKSERET	UDENDØRS	RUSTFRIT STÅL-LOOK	UDENDØRS
	Art. nr.		Art. nr.		Art. nr.	
Indvendigt hjørne	135.6SI.100	1	135.6SI.101	1	135.6SI.102	1
MODEL: 6011	PULVERLAKERET	UDENDØRS				
	Art. nr.					
Indvendigt hjørne	135.6SI.103	1				

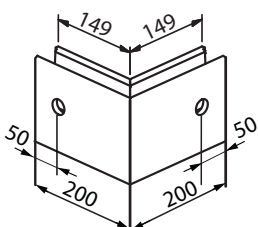

▼ UDVENDIGT HJØRNE

MODEL: 6011	RÅ ALUMINIUM	UDENDØRS	NATURELOKSERET	UDENDØRS	RUSTFRIT STÅL-LOOK	UDENDØRS
	Art. nr.		Art. nr.		Art. nr.	
Udvendigt hjørne	135.6SU.100	1	135.6SU.101	1	135.6SU.102	1
MODEL: 6011	PULVERLAKERET	UDENDØRS				
	Art. nr.					
Udvendigt hjørne	135.6SU.103	1				

ONLEVEL 6011 | 1,0 KN SIDEMONTERET DIREKTE

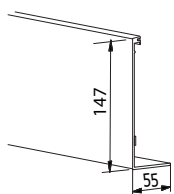

DÆKKAPPE						
MODEL: 6011	RÅ ALUMINIUM	UDENDØRS	NATURELOKSERET	UDENDØRS	RUSTFRIT STÅL-LOOK	UDENDØRS
Længde	Art. nr.		Art. nr.		Art. nr.	
2.500 mm	-	-	135.6C2.101	1	-	-
5.000 mm	135.6C5.100	1	135.6C5.101	1	135.6C5.102	1
MODEL: 6011	PULVERLAKERET	UDENDØRS				
Længde	Art. nr.					
5.000 mm	135.6C5.103	1				

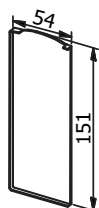

ENDEBUND TIL DÆKKAPPE						
MODEL: 6011	RÅ ALUMINIUM	UDENDØRS	NATURELOKSERET	UDENDØRS	RUSTFRIT STÅL-LOOK	UDENDØRS
Side	Art. nr.		Art. nr.		Art. nr.	
Venstre	135.6CL.100	1	135.6CL.101	1	135.6CL.102	1
Højre	135.6CR.100	1	135.6CR.101	1	135.6CR.102	1
MODEL: 6011	PULVERLAKERET	UDENDØRS				
Side	Art. nr.					
Venstre	135.6CL.103	1				
Højre	135.6CR.103	1				

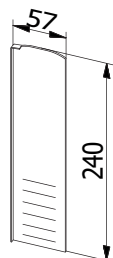

ENDEBUND TRAPPE TIL DÆKKAPPE						
MODEL: 6011	RÅ ALUMINIUM	UDENDØRS	NATURELOKSERET	UDENDØRS	RUSTFRIT STÅL-LOOK	UDENDØRS
Side	Art. nr.		Art. nr.		Art. nr.	
Venstre	135.6CL.1T0	1	135.6CL.1T1	1	135.6CL.1T2	1
Højre	135.6CR.1T0	1	135.6CR.1T1	1	135.6CR.1T2	1
MODEL: 6011	PULVERLAKERET	UDENDØRS				
Side	Art. nr.					
Venstre	135.6CL.1T3	1				
Højre	135.6CR.1T3	1				

ONLEVEL 6011 | 1,0 KN SIDEMONTERET DIREKTE

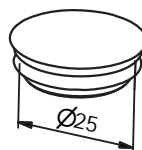
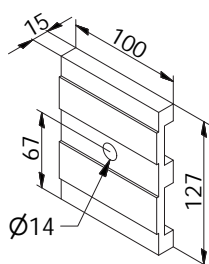

AFSTANDSKLODS		
MODEL: 6011	NATURELOKSERET	UDENDØRS
Art. nr.	pr. 2.500 mm	
135.6SA.101	10 stk.	10

DÆKPROP		
MODEL: 7000	GRÅ PLAST	UDENDØRS
Art. nr.	pr. 2.500 mm	
135.CAP.000	10 stk.	10

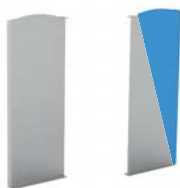
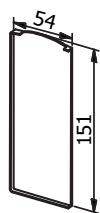

ENDEBUND UDEN DÆKKAPPE						
MODEL: 6011	RÅ ALUMINIUM	UDENDØRS	NATURELOKSERET	UDENDØRS	RUSTFRIT STÅL-LOOK	UDENDØRS
Side	Art. nr.		Art. nr.		Art. nr.	
Venstre	135.6SL.100	1	135.6SL.101	1	135.6SL.102	1
Højre	135.6SR.100	1	135.6SR.101	1	135.6SR.102	1
MODEL: 6011	PULVERLAKERET	UDENDØRS				
Side	Art. nr.					
Venstre	135.6SL.103	1				
Højre	135.6SR.103	1				

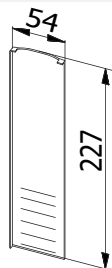

ENDEBUND TRAPPE UDEN DÆKKAPPE						
MODEL: 6011	RÅ ALUMINIUM	UDENDØRS	NATURELOKSERET	UDENDØRS	RUSTFRIT STÅL-LOOK	UDENDØRS
Side	Art. nr.		Art. nr.		Art. nr.	
Venstre	135.6SL.1T0	1	135.6SL.1T1	1	135.6SL.1T2	1
Højre	135.6SR.1T0	1	135.6SR.1T1	1	135.6SR.1T2	1
MODEL: 6011	PULVERLAKERET	UDENDØRS				
Side	Art. nr.					
Venstre	135.6SL.1T3	1				
Højre	135.6SR.1T3	1				



TOPCOVER PROFIL PASSER PERFEKT TIL DIT PROJEKT

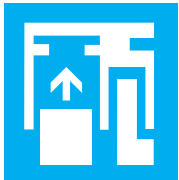

TopCover tilpasningsprofil

Indespændte helglasværn anvendes i mange projekter, hvor de indgår diskret i den øvrige konstruktion, og hvor værnprofilerne i sig selv ikke behøver at være en synlig del af den færdige løsning. OnLevel TopCover profiler giver en nem og elegant standardtilpasning til inddækning eller beklædning i alle materialer.

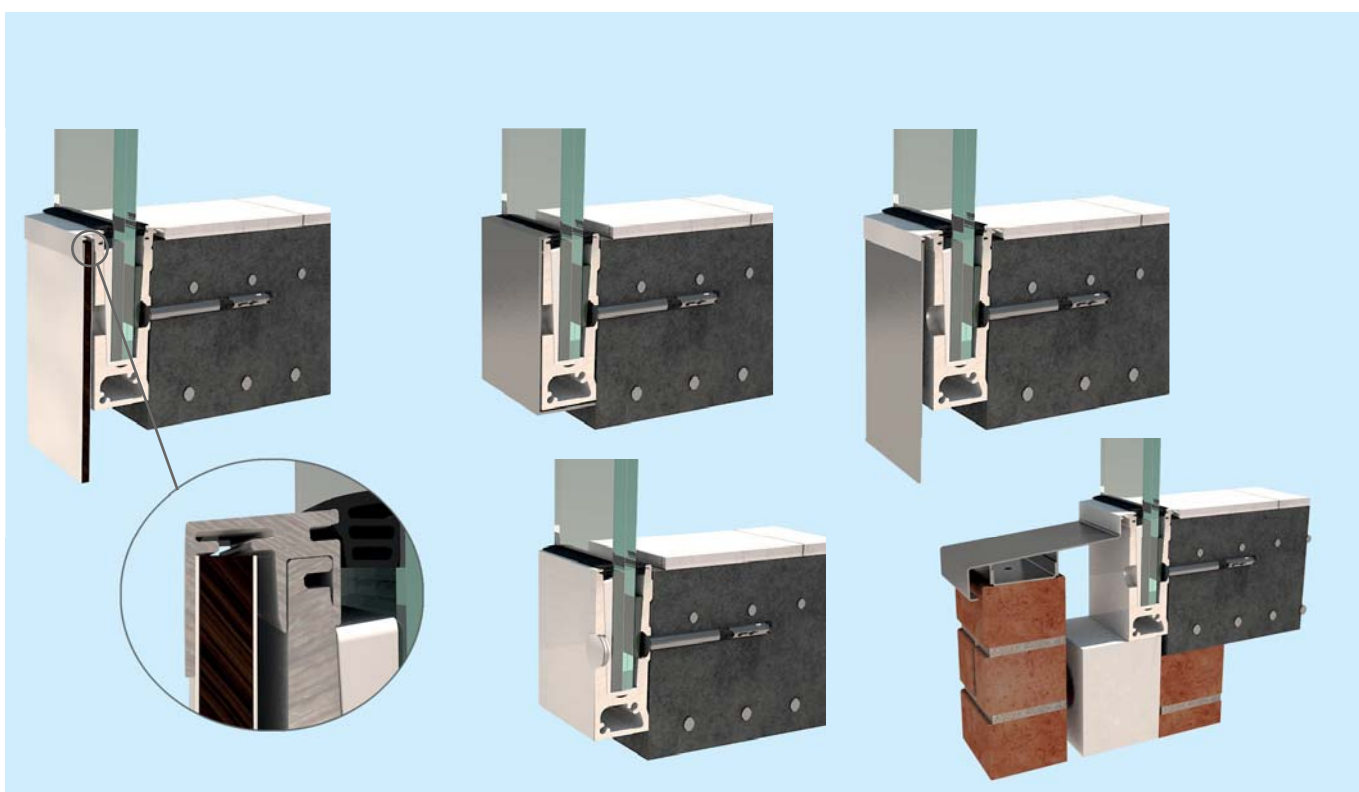

ONLEVEL TOPCOVER TILPASNINGSPROFIL

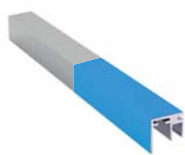
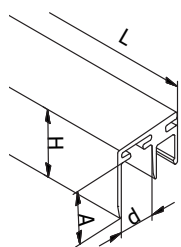

TOPCOVER				RÅ ALUMINIUM		UDENDØRS		NATURELOKERET		UDENDØRS		RUSTFRIT STÅL-LOOK		UDENDØRS	
MODEL: 8010	d	Længde	H	A	Art. nr.		Art. nr.		Art. nr.		Art. nr.		Art. nr.		Art. nr.
	3	5.000 mm	14	10	135.103.5C0	1	135.103.5C1	1	135.103.5C2	1	135.103.5C3	1	135.103.5C4	1	135.103.5C5
	10	5.000 mm	20	16	135.110.5C0	1	135.110.5C1	1	135.110.5C2	1	135.110.5C3	1	135.110.5C4	1	135.110.5C5
	15	5.000 mm	20	16	135.115.5C0	1	135.115.5C1	1	135.115.5C2	1	135.115.5C3	1	135.115.5C4	1	135.115.5C5
	20	5.000 mm	20	16	135.120.5C0	1	135.120.5C1	1	135.120.5C2	1	135.120.5C3	1	135.120.5C4	1	135.120.5C5
	120	5.000 mm	20	16	135.121.5C0	1	135.121.5C1	1	135.121.5C2	1	135.121.5C3	1	135.121.5C4	1	135.121.5C5
MODEL: 8010	d	Længde	H	A	Art. nr.		Art. nr.		Art. nr.		Art. nr.		Art. nr.		Art. nr.
	3	5.000 mm	14	10	135.103.5C3	1									
	10	5.000 mm	20	16	135.110.5C3	1									
	15	5.000 mm	20	16	135.115.5C3	1									
	20	5.000 mm	20	16	135.120.5C3	1									
	120	5.000 mm	20	16	135.121.5C3	1									

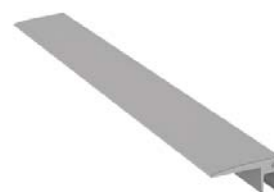
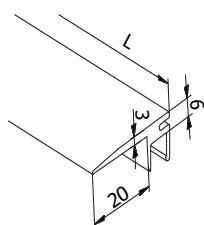

TOPCOVER TIL GULV		RÅ ALUMINIUM		UDENDØRS		NATURELOKERET		UDENDØRS		RUSTFRIT STÅL-LOOK		UDENDØRS	
MODEL: 8110	Længde	Art. nr.		Art. nr.		Art. nr.		Art. nr.		Art. nr.		Art. nr.	
	5.000 mm	135.120.5F0	1	135.120.5F1	1	135.120.5F2	1	135.120.5F3	1	135.120.5F4	1	135.120.5F5	1
MODEL: 8110	Længde	Art. nr.		Art. nr.		Art. nr.		Art. nr.		Art. nr.		Art. nr.	
	5.000 mm	135.120.5F3	1										

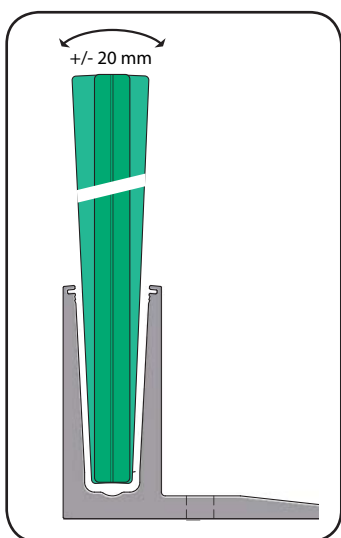

Enkel og præcis justering

OnLevel Flex-Fit er løsningen til perfekt, hurtig og sikker justering af glasværn. Med en enkelt trinløs bevægelse justerer du glasset præcist op til +/- 20 mm og reducerer montagetiden med omkring 30%. Flex-Fit systemet kan anvendes med alle OnLevel værnprofiler.

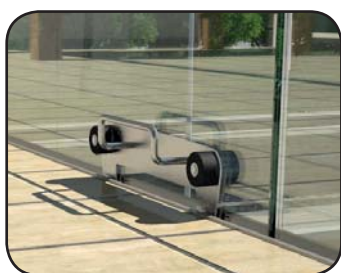

Håndteres fra indvendig side

Udover at reducere montagetiden med 30%, har det unikke Flex-Fit system flere fordele at byde på. I modsætning til traditionelle systemer, hvor du er nødt til at arbejde på begge sider af glasset, håndteres Flex-Fit fra den indvendige side. På denne måde sparer du tid og udgifter til stillads eller lift, samtidig med at arbejdet udføres mere sikkert.



OnLevel Flex-Fit værktøj

For hurtig og perfekt justering af det enkelte glas, har OnLevel udviklet det praktiske Flex-Fit værktøj. Med blot en enkelt bevægelse kan glasset justeres millimeterpræcist. Se demovideo på vores hjemmeside.

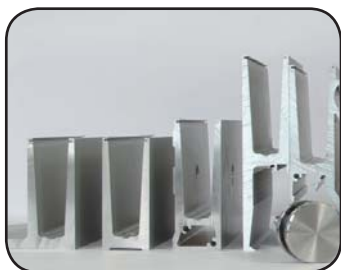

Bruges med alle OnLevel værnprofiler

Endnu en fordel: Flex-Fit leveres som standard til alle OnLevel værnprofiler, så du fremover vil kunne anvende samme løsning til alle projekter, dagligdags såvel som de mere udfordrende. Du får alle fordelene, som Flex-Fit-systemet tilbyder, herunder justeringsnøjagtighed, håndtering fra indvendig side samt Flex-Fit værktøjets brugervenlighed.



Glastykkelser fra 12 til 31,52 mm

Flex-Fit kan anvendes til et bredt udvalg af glastykkelser, fra 12 mm helt op til 31,52 mm. Du kan vælge at anvende den samme systemløsning ved alle projekter fremover, hvilket sparer dig tid og omkostninger.

ONLEVEL FLEX-FIT / MONTAGETILBEHØR

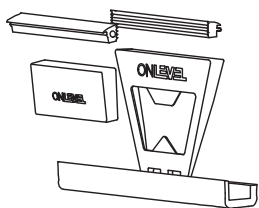

FLEX-FIT 1.0 KN				
MODEL: 0505		GUMMI	UDENDØRS	
Længde	Glastykkelse	Kile	Art. nr.	
5.000 mm	12		135.112.BLA	1
5.000 mm	6/6/2 (12,76 mm)		135.113.RED	1
5.000 mm	6/6/4 (13,52 mm)		135.114.GRE	1
5.000 mm	15		135.115.YEL	1
5.000 mm	8/8/2 (16,76 mm)		135.117.BRW	1
5.000 mm	8/8/4 (17,52 mm)		135.118.GRE	1
5.000 mm	19		135.119.BLU	1
5.000 mm	10/10/2 (20,76 mm)		135.121.RED	1
5.000 mm	10/10/4 (21,52 mm)		135.122.GRE	1



FLEX-FIT VÆRKTØJ		
MODEL: 0100	STÅL	UDENDØRS
Art. nr.		
135.FFT.000	1	



COMBI VÆRKTØJ		
MODEL: 0100	STÅL	UDENDØRS
Art. nr.		
135.COM.000	1	

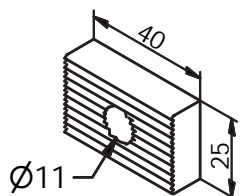

MONTAGEBESLAG - 3011		
MODEL: 7002	ALUMINIUM	UDENDØRS
Art. nr.	pr. 2.500 mm	
135.BLO.000	7 stk.	8

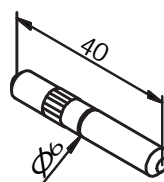

SAMLEPIND		
MODEL: 7001	AISI 316	UDENDØRS
Art. nr.		
135.PIN.000	8	



DÆKPROP - 6011		
MODEL: 7000	GRÅ PLAST	UDENDØRS
Art. nr.	pr. 2.500 mm	
135.CAP.000	10 stk.	10

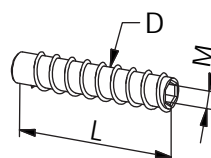

INDSATS FOR TRÆ				
MODEL: 2110/2112/2116	AISI 316	UDENDØRS		
Art. nr.	L	D	M	
135.GEV.072	70	Ø18,5	M10	50
135.GEV.082	80	Ø22	M12	50
135.GEV.102	100	Ø22	M16	50

ONLEVEL MONTAGETILBEHØR BOLTE / LIM

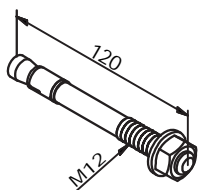

MONTERINGSANKER - TL3010

MODEL: 3501	GALVANISERET	INDENDØRS
Art. nr.	pr. 2.500 mm	
135.MOI.120	7 stk.	20
MODEL: 3501	AISI 316	UDENDØRS
Art. nr.	pr. 2.500 mm	
135.MOU.120	7 stk.	20

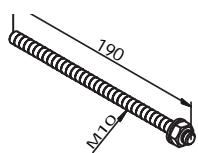

MONTERINGSANKER - TL3011

MODEL: 3541	GALVANISERET	INDENDØRS
Art. nr.	pr. 2.500 mm	
135.MOI.190	7 stk.	10
MODEL: 3541	AISI 316	UDENDØRS
Art. nr.	pr. 2.500 mm	
135.MOU.190	7 stk.	10

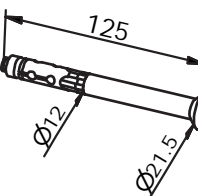

MONTERINGSANKER - TL6010

MODEL: 3511	GALVANISERET	INDENDØRS
Art. nr.	pr. 2.500 mm	
135.MOI.125	17 stk.	25
MODEL: 3511	AISI 316	UDENDØRS
Art. nr.	pr. 2.500 mm	
135.MOU.125	17 stk.	25

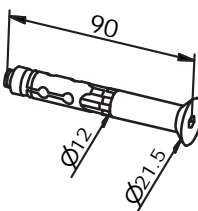

MONTERINGSANKER - TL6011

MODEL: 3511	GALVANISERET	INDENDØRS
Art. nr.	pr. 2.500 mm	
135.MOI.090	10 stk.	25
MODEL: 3511	AISI 316	UDENDØRS
Art. nr.	pr. 2.500 mm	
135.MOU.090	10 stk.	25



INJEKTIONSLIM

MODEL: 3000	BLANDEPATRON	UDENDØRS
Art. nr.	Indhold	
135.INJ.000	390 ml	1



MONTERINGSLIM TRANSPARENT

MODEL: 7006	PATRON	UDENDØRS
Art. nr.	Indhold	
135.MON.000	290 ml	1



RUSTFRIT STÅL LIM

MODEL: 7005	LIM	UDENDØRS
Art. nr.	Indhold	
135.LIM.000	50 ml	1

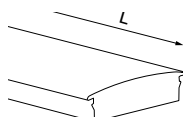

FORSEGLINGSGUMMI

MODEL: 2005	GUMMI	UDENDØRS
Art. nr.	Længde	
135.G15.000	5.000 mm	1



BLANDEPISTOL TIL INJEKTIONSLIM	
MODEL: 3002	PLAST
Art. nr. 	
135.DIS.000	1



BLÆSEPUMPE	
MODEL: 3001	PLAST
Art. nr. 	
135.SPR.000	1

FLEKSIBILITET OG EFFEKTIVITET

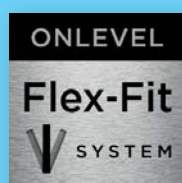

OnLevel Flex-Fit er det perfekte system, når det gælder fleksibel justering af indespændt glas. Flex-Fit gør det muligt at justere hvert glaspanel op til +/- 20 mm i forhold til lodret position.

Flex-Fit systemet

OnLevel har udviklet det praktiske Flex-Fit system for at gøre hurtig og perfekt justering af glas mulig. Flex-Fit lader dig justere glasværn med en enkelt håndtering - millimeterpræcist.

Hurtigt og præcist

Med en enkelt trinløs bevægelse er det muligt at præcisions justere glasset – dette reducerer montagetiden med ca. 30%. Flex-Fit kan benyttes sammen med alle OnLevel værnprofiler og glas fra 12 mm til 31,52 mm.

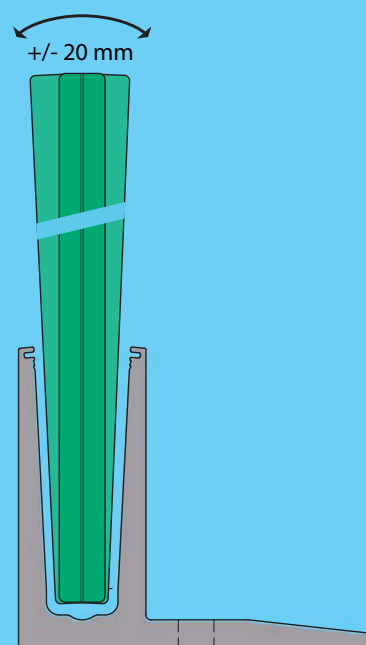

Simpelt og overkommeligt

De fleste traditionelle systemer kræver, at der arbejdes fra både indvendig og udvendig side af glasset. Flex-Fit kan håndteres udelukkende fra indvendig side, hvilket gør det mere sikkert samt sparer montagetid og omkostninger til hjælpematerialer.

ONLEVEL HÅNDLISTE RUND - ALUMINIUM

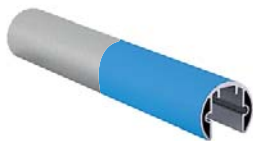
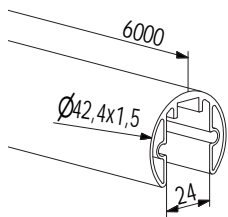

▼ HÅNDLISTE Ø42,4 MM

MODEL: 2106		RÅ ALUMINIUM	UDENDØRS	NATURELOKSERET	UDENDØRS	RUSTFRIT STÅL-LOOK	UDENDØRS
Diameter	Not	Art. nr.		Art. nr.		Art. nr.	
Ø42,4x1,5 mm	24 mm	135.R42.A60	1	135.R42.A61	1	135.R42.A62	1
MODEL: 2106		PULVERLAKERET	UDENDØRS				
Diameter	Not	Art. nr.					
Ø42,4x1,5 mm	24 mm	135.R42.A63	1				

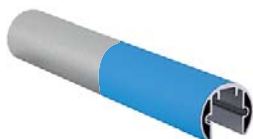
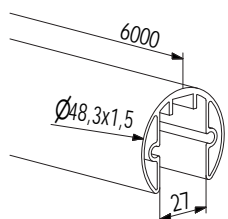

▼ HÅNDLISTE Ø48,3 MM

MODEL: 2106		RÅ ALUMINIUM	UDENDØRS	NATURELOKSERET	UDENDØRS	RUSTFRIT STÅL-LOOK	UDENDØRS
Diameter	Not	Art. nr.		Art. nr.		Art. nr.	
Ø48,3x1,5 mm	27 mm	135.R48.A60	1	135.R48.A61	1	135.R48.A62	1
MODEL: 2106		PULVERLAKERET	UDENDØRS				
Diameter	Not	Art. nr.					
Ø48,3x1,5 mm	27 mm	135.R48.A63	1				

ONLEVEL HÅNDLISTE U-PROFIL - ALUMINIUM

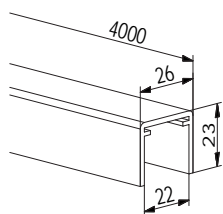

HÅNDLISTE B26 MM

MODEL: 2114		RÅ ALUMINIUM	UDENDØRS	NATURELOKSERET	UDENDØRS	RUSTFRIT STÅL-LOOK	UDENDØRS
Udv. B x H	Not	Art. nr.		Art. nr.		Art. nr.	
26 x 23 mm	22 mm	135.U26.A40	1	135.U26.A41	1	135.U26.A42	1
MODEL: 2114		PULVERLAKERET	UDENDØRS				
Udv. B x H	Not	Art. nr.					
26 x 23 mm	22 mm	135.U26.A43	1				

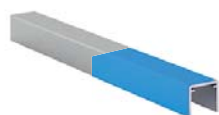
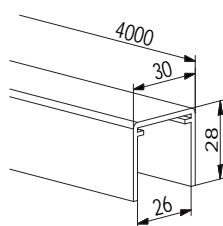

HÅNDLISTE B30 MM

MODEL: 2114		RÅ ALUMINIUM	UDENDØRS	NATURELOKSERET	UDENDØRS	RUSTFRIT STÅL-LOOK	UDENDØRS
Udv. B x H	Not	Art. nr.		Art. nr.		Art. nr.	
30 x 28 mm	26 mm	135.U30.A40	1	135.U30.A41	1	135.U30.A42	1
MODEL: 2114		PULVERLAKERET	UDENDØRS				
Udv. B x H	Not	Art. nr.					
30 x 28 mm	26 mm	135.U30.A43	1				

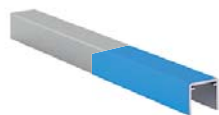
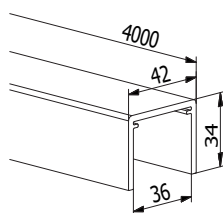

HÅNDLISTE B42 MM

MODEL: 2114		RÅ ALUMINIUM	UDENDØRS	NATURELOKSERET	UDENDØRS	RUSTFRIT STÅL-LOOK	UDENDØRS
Udv. B x H	Not	Art. nr.		Art. nr.		Art. nr.	
42 x 34 mm	36 mm	135.U40.A40	1	135.U40.A41	1	135.U40.A42	1
MODEL: 2114		PULVERLAKERET	UDENDØRS				
Udv. B x H	Not	Art. nr.					
42 x 34 mm	36 mm	135.U40.A43	1				

ONLEVEL HÅNDLISTE RUSTFRIT STÅL

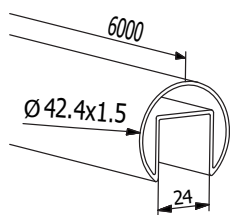

▼ HÅNDLISTE Ø42,4 MM

MODEL: 2106		AISI 304	INDENDØRS
Diameter	Not	Art. nr.	
Ø42,4x1,5 mm	24 mm	135.R42.621	1
MODEL: 2106		AISI 316	UDENDØRS
Diameter	Not	Art. nr.	
Ø42,4x1,5 mm	24 mm	135.R42.631	1

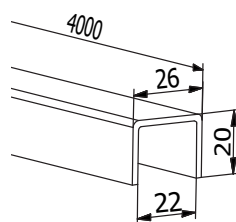

▼ HÅNDLISTE B25 MM

MODEL: 2114		AISI 304	INDENDØRS
Udv. B x H	Not	Art. nr.	
26 x 20 mm	22 mm	135.U26.421	1
MODEL: 2114		AISI 316	UDENDØRS
Udv. B x H	Not	Art. nr.	
26 x 20 mm	22 mm	135.U26.431	1

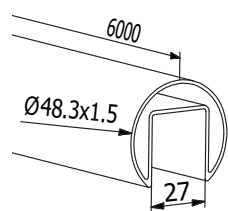

▼ HÅNDLISTE Ø48,3 MM

MODEL: 2106		AISI 304	INDENDØRS
Diameter	Not	Art. nr.	
Ø48,3x1,5 mm	27 mm	135.R48.621	1
MODEL: 2106		AISI 316	UDENDØRS
Diameter	Not	Art. nr.	
Ø48,3x1,5 mm	27 mm	135.R48.631	1

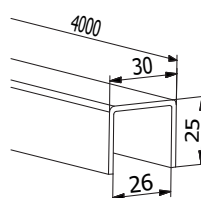

▼ HÅNDLISTE B30 MM

MODEL: 2114		AISI 304	INDENDØRS
Udv. B x H	Not	Art. nr.	
30 x 25 mm	26 mm	135.U30.421	1
MODEL: 2114		AISI 316	UDENDØRS
Udv. B x H	Not	Art. nr.	
30 x 25 mm	26 mm	135.U30.431	1

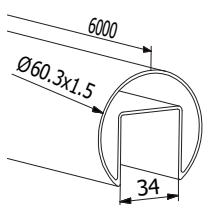

▼ HÅNDLISTE Ø60,3 MM

MODEL: 2106		AISI 304	INDENDØRS
Diameter	Not	Art. nr.	
Ø60,3x1,5 mm	34 mm	135.R60.621	1
MODEL: 2106		AISI 316	UDENDØRS
Diameter	Not	Art. nr.	
Ø60,3x1,5 mm	34 mm	135.R60.631	1

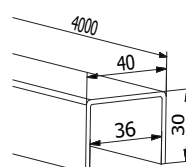

▼ HÅNDLISTE B40 MM

MODEL: 2114		AISI 304	INDENDØRS
Udv. B x H	Not	Art. nr.	
40 x 30 mm	36 mm	135.U40.421	1
MODEL: 2114		AISI 316	UDENDØRS
Udv. B x H	Not	Art. nr.	
40 x 30 mm	36 mm	135.U40.431	1

ONLEVEL HÅNDLISTE GUMMI

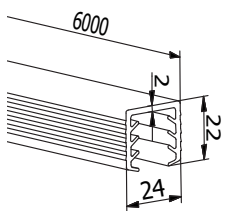

GUMMI TIL HÅNDLISTE Ø42,4 MM FOR NOT 24		
MODEL: 6542	GUMMI	UDENDØRS
Glastykkelse	Art. nr.	
8 - 11 mm	135.24R.608	1
11,5 - 13,5 mm	135.24R.611	1
15 mm	135.24R.615	1
16 - 17,5 mm	135.24R.616	1
19 mm	135.24R.619	1
20 - 21,5 mm	135.24R.620	1

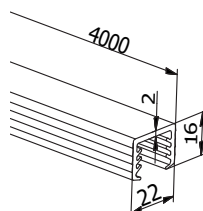

GUMMI TIL U-PROFIL B26 MM FOR NOT 22		
MODEL: 6526	GUMMI	UDENDØRS
Glastykkelse	Art. nr.	
8 - 11 mm	135.22U.408	1
11,5 - 13,5 mm	135.22U.411	1
15 mm	135.22U.415	1
16 - 17,5 mm	135.22U.416	1

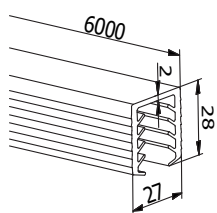

GUMMI TIL HÅNDLISTE Ø48,3 MM FOR NOT 27		
MODEL: 6548	GUMMI	UDENDØRS
Glastykkelse	Art. nr.	
8 - 11 mm	135.27R.608	1
11,5 - 13,5 mm	135.27R.611	1
15 mm	135.27R.615	1
16 - 17,5 mm	135.27R.616	1
19 mm	135.27R.619	1
20 - 21,5 mm	135.27R.620	1

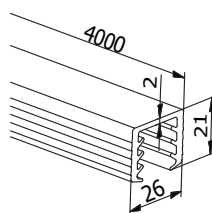

GUMMI TIL U-PROFIL B30 MM FOR NOT 26		
MODEL: 6530	GUMMI	UDENDØRS
Glastykkelse	Art. nr.	
8 - 11 mm	135.26U.408	1
11,5 - 13,5 mm	135.26U.411	1
15 mm	135.26U.415	1
16 - 17,5 mm	135.26U.416	1
19 mm	135.26U.419	1
20 - 21,5 mm	135.26U.420	1

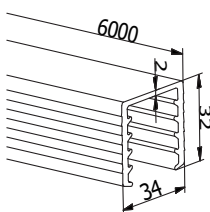

GUMMI TIL HÅNDLISTE Ø60,3 MM FOR NOT 34		
MODEL: 6560	GUMMI	UDENDØRS
Glastykkelse	Art. nr.	
16 - 17,5 mm	135.34R.616	1
19 mm	135.34R.619	1
20 - 21,5 mm	135.34R.620	1
24,5 - 25,5 mm	135.34R.624	1
30,5 - 31,5 mm	135.34R.630	1

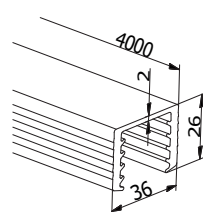

GUMMI TIL U-PROFIL B40 /B42 MM FOR NOT 36		
MODEL: 6540	GUMMI	UDENDØRS
Glastykkelse	Art. nr.	
20,5 - 21,5 mm	135.36U.420	1
24,5 - 25,5 mm	135.36U.424	1
30,5 - 31,5 mm	135.36U.430	1

ONLEVEL HÅNDLISTE TILBEHØR - ALUMINIUM

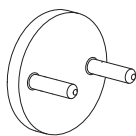

FLAD ENDEBUND

MODEL: 2300	RÅ ALUMINIUM	UDENDØRS	NATURELOKERET	UDENDØRS	RUSTFRIT STÅL-LOOK	UDENDØRS
Diameter	Art. nr.		Art. nr.		Art. nr.	
Ø42,4 mm	135.E42.000	2	135.E42.001	2	135.E42.002	2
Ø48,3 mm	135.E48.000	2	135.E48.001	2	135.E48.002	2
MODEL: 2300	PULVERLAKERET	UDENDØRS				
Diameter	Art. nr.					
Ø42,4 mm	135.E42.003	2				
Ø48,3 mm	135.E48.003	2				

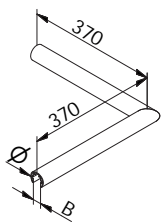

HJØRNESAMLING FOR RUND HÅNDLISTE

MODEL: 2210	RÅ ALUMINIUM	UDENDØRS	NATURELOKERET	UDENDØRS	RUSTFRIT STÅL-LOOK	UDENDØRS
B Diameter	Art. nr.		Art. nr.		Art. nr.	
Ø42,4 mm	135.H42.000	1	135.H42.001	1	135.H42.002	1
Ø48,3 mm	135.H48.000	1	135.H48.001	1	135.H48.002	1
MODEL: 2210	PULVERLAKERET	UDENDØRS				
B Diameter	Art. nr.					
Ø42,4 mm	135.H42.003	1				
Ø48,3 mm	135.H48.003	1				

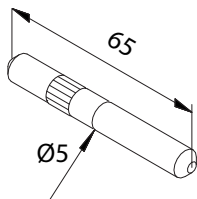

SAMLEPIND TIL RUND HÅNDLISTE

MODEL: 7001	AISI 316	UDENDØRS
Art. nr.		
135.RSA.000		8

ONLEVEL HÅNDLISTE TILBEHØR U-PROFIL - ALUMINIUM

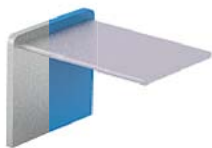
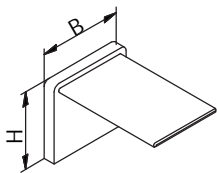

FLAD ENDEBUND U-PROFIL							
MODEL: 2300		RÅ ALUMINIUM	UDENDØRS	NATURELOKSERET	UDENDØRS	RUSTFRIT STÅL-LOOK	UDENDØRS
Bredde	Højde	Art. nr.		Art. nr.		Art. nr.	
26 mm	23 mm	135.E26.000	2	135.E26.001	2	135.E26.002	2
30 mm	28 mm	135.E30.000	2	135.E30.001	2	135.E30.002	2
42 mm	34 mm	135.E40.000	2	135.E40.001	2	135.E40.002	2
MODEL: 2300		PULVERLAKERET	UDENDØRS				
Bredde	Højde	Art. nr.					
26 mm	23 mm	135.E26.003	2				
30 mm	28 mm	135.E30.003	2				
42 mm	34 mm	135.E40.003	2				

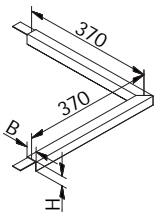

HJØRNESAMLING FOR U-PROFIL HÅNDLISTE							
MODEL: 2210		RÅ ALUMINIUM	UDENDØRS	NATURELOKSERET	UDENDØRS	RUSTFRIT STÅL-LOOK	UDENDØRS
Bredde	Højde	Art. nr.		Art. nr.		Art. nr.	
26 mm	23 mm	135.H26.000	1	135.H26.001	1	135.H26.002	1
30 mm	28 mm	135.H30.000	1	135.H30.001	1	135.H30.002	1
42 mm	34 mm	135.H40.000	1	135.H40.001	1	135.H40.002	1
MODEL: 2210		PULVERLAKERET	UDENDØRS				
Bredde	Højde	Art. nr.					
26 mm	23 mm	135.H26.003	1				
30 mm	28 mm	135.H30.003	1				
42 mm	34 mm	135.H40.003	1				

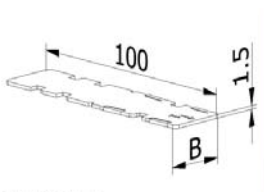

SAMLESTYKKE TIL U-PROFIL HÅNDLISTE			
MODEL: 2200		RÅ ALUMINIUM	UDENDØRS
Bredde	Art. nr.		
22 mm	135.U25.000		2
26 mm	135.U35.000		2
36 mm	135.U45.000		2

ONLEVEL HÅNDLISTE TILBEHØR RUSTFRIT STÅL

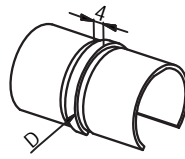
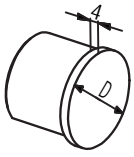

FLAD ENDEBUND RUND

MODEL: 2300	AISI 304	INDENDØRS
Diameter	Art. nr.	
Ø42,4 mm	135.R42.E21	2
Ø48,3 mm	135.R48.E21	2
Ø60,3 mm	135.R60.E21	2
MODEL: 2300	AISI 316	UDENDØRS
Diameter	Art. nr.	
Ø42,4 mm	135.R42.E31	2
Ø48,3 mm	135.R48.E31	2
Ø60,3 mm	135.R60.E31	2

180° SAMLESTYKKE RUND

MODEL: 2200	AISI 304	INDENDØRS
Diameter	Art. nr.	
Ø42,4 mm	135.R42.S21	2
Ø48,3 mm	135.R48.S21	2
Ø60,3 mm	135.R60.S21	2
MODEL: 2200	AISI 316	UDENDØRS
Diameter	Art. nr.	
Ø42,4 mm	135.R42.S31	2
Ø48,3 mm	135.R48.S31	2
Ø60,3 mm	135.R60.S31	2

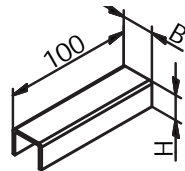
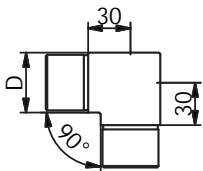

HJØRNESAMLING RUND

MODEL: 2210	AISI 304	INDENDØRS
Diameter	Art. nr.	
Ø42,4 mm	135.R42.H21	2
Ø48,3 mm	135.R48.H21	2
Ø60,3 mm	135.R60.H21	2
MODEL: 2300	AISI 316	UDENDØRS
Diameter	Art. nr.	
Ø42,4 mm	135.R42.H31	2
Ø48,3 mm	135.R48.H31	2
Ø60,3 mm	135.R60.H31	2

ENDESTYKKE U-PROFIL

MODEL: 2300	AISI 304	INDENDØRS	
Bredde	Højde	Art. nr.	
26 mm	20 mm	135.U26.E21	1
30 mm	25 mm	135.U30.E21	1
40 mm	30 mm	135.U40.E21	1
MODEL: 2300	AISI 316	UDENDØRS	
Bredde	Højde	Art. nr.	
26 mm	20 mm	135.U26.E31	1
30 mm	25 mm	135.U30.E31	1
40 mm	30 mm	135.U40.E31	1

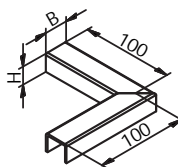
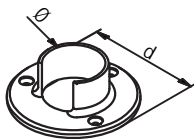

VÆGFLANGE RUND

MODEL: 2220	AISI 304	INDENDØRS
Diameter	Art. nr.	
Ø42,4 mm	135.R42.F21	2
Ø48,3 mm	135.R48.F21	2
Ø60,3 mm	135.R60.F21	2
MODEL: 2220	AISI 316	UDENDØRS
Diameter	Art. nr.	
Ø42,4 mm	135.R42.F31	2
Ø48,3 mm	135.R48.F31	2
Ø60,3 mm	135.R60.F31	2

HJØRNESAMLING U-PROFIL

MODEL: 2210	AISI 304	INDENDØRS	
Bredde	Højde	Art. nr.	
26 mm	20 mm	135.U26.H21	1
30 mm	25 mm	135.U30.H21	1
40 mm	30 mm	135.U40.H21	1
MODEL: 2210	AISI 316	UDENDØRS	
Bredde	Højde	Art. nr.	
26 mm	20 mm	135.U26.H31	1
30 mm	25 mm	135.U30.H31	1
40 mm	30 mm	135.U40.H31	1

ONLEVEL

BALUSTRADES

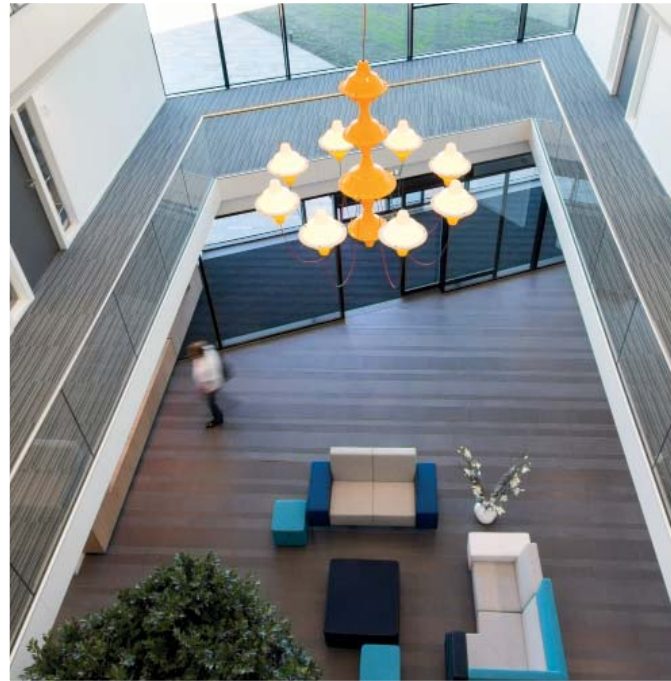
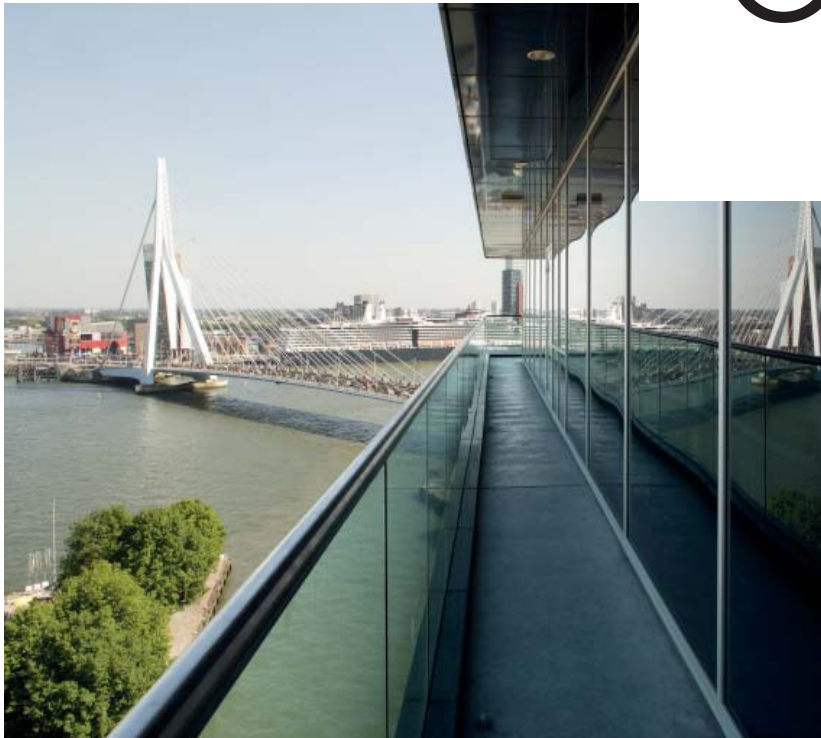



HansenLellinge – glas og dørteknik til professionelle

HansenLellinge A/S leverer løsninger til glaskonstruktioner og dørteknik fra anerkendte kvalitetsleverandører af profilsystemer, beslag, låse, dørautomatik og glarmesterprodukter.

Vi yder kompetent teknisk og praktisk rådgivning, og deltager gerne i projektet fra idéfasen til færdiggørelse. Vores udstilling og vore faguddannede medarbejdere står til rådighed, og vi henviser gerne til relevante håndværkere.

Vi lagerfører et omfattende sortiment af produkter og tilbehør, for hurtig levering og høreget værksted for tilpasning og specialløsninger.



Velkommen hos Hansen Lellinge A/S og på www.hansenlellinge.dk

Hansen Lelling A/S

Mårkærvej 7
2630 Taastrup
www.hansenlellinge.dk
info@hansenlellinge.dk

Kundeservice: 43 71 16 40
Konsulent sikring: 40 73 95 40
Konsulent øst: 31 27 17 49
Konsulent vest: 24 98