



# P-DUKE POWER

## TBF500 Series

Full-Brick AC-DC Power Supplies  
Up to 500 Watts

**3**  
YEARS  
WARRANTY

ROHS  
COMPLIANT

REACH  
COMPLIANT



Automation



Datacom



IPC



Industry



Measurement



Telecom



Automobile



Boat



Charger



Medical



PV



Railway



**3000 VAC**  
Reinforced  
Insulation

**NO**  
Min. Load  
Required

**POWER GOOD**

**REMOTE ON OFF**

Active Droop  
Current Share

**LOW**  
Standby  
Power

**OCP**

**OTP**

**OVP**

**SCP**

**OVCIII**

### PART NUMBER STRUCTURE

**TBF 500**

**U**

**S**

**12**

**-**

**S**

Series  
Name

Output  
Power  
(W)

Input  
Voltage  
(VAC)

Output  
Quantity

Output  
Voltage  
(VDC)

Load Share  
Options

U: Universal  
85 ~ 264

S: Single

12:12  
15:15  
24:24  
28:28  
48:48  
54:54

□: None  
S: Load Share

**TECHNICAL SPECIFICATION** All specifications are typical at 230VAC input, full load and 25°C unless otherwise noted

Model Number	Input Range	Output Voltage	Output Current @ 230VAC Conduction Cooling	Input Power @ No Load	Efficiency	Maximum Capacitor Load
	VAC	VDC	A	W	%	µF
TBF500US12	85 ~ 264	12	42	0.6	91	20000
TBF500US15	85 ~ 264	15	33.5	0.6	91	12000
TBF500US24	85 ~ 264	24	21	0.6	93	4000
TBF500US28	85 ~ 264	28	18	0.6	93	3000
TBF500US48	85 ~ 264	48	10.5	0.6	93	1000
TBF500US54	85 ~ 264	54	9.4	0.6	93	820

### INPUT SPECIFICATIONS

Parameter	Conditions	Min.	Typ.	Max.	Unit
Operating input voltage range	AC input	85		264	VAC
	DC input	88		370	VDC
Input frequency	AC input	47		63	Hz
Input current	100VAC and Full Load			6.3	A
	240VAC and Full Load			2.7	
No load input power	230VAC		0.6		Watts
Power Factor	230VAC and Full Load	0.95			
Start up time				2000	ms
Rise time			20		ms
Hold up time	115VAC and Full Load		16		ms
Input inrush current	230VAC and Full Load		30		A
Input protection	External fuse in line			T10A/250VAC	

OUTPUT SPECIFICATIONS						
Parameter	Conditions		Min.	Typ.	Max.	Unit
Output power	Conduction cooling @ 230VAC *Please refer to the derating curve for detailed rating.				500	Watts
Voltage accuracy	230VAC and Full Load		-1.0		+1.0	%
Line regulation	Low Line to High Line at Full Load		-0.2		+0.2	%
Load regulation	No Load to Full Load		-0.5		+0.5	%
	10% Load to 90% Load		-0.4		+0.4	
Voltage adjustability	Maximum output deviation is inclusive of remote sense Only For Load Share Models (-S suffix)		-10		+10	%
Remote sense	% of Vout(nom) If remote sense is not being used, Sense pins should be connected to corresponding polarity OUTPUT pins.				10	%
Minimum load				0		%
Ripple and noise	Measured by 20MHz bandwidth					
	With a 1 $\mu$ F/50V 1206 X7R MLCC	12Vout		200		mVp-p
		15Vout		200		
		24Vout		240		
28Vout			280			
With a 1 $\mu$ F/100V 1206 X7R MLCC	48Vout		480		mVp-p	
	54Vout		540			
Temperature coefficient			-0.02		+0.02	%/°C
Transient response	Load step from 50 ~ 75% change at 2.5A/ $\mu$ s Recovery within 1% Vout	Peak deviation		3		% Vout
		Recovery time		600		$\mu$ s
Over voltage protection	% of Vout(nom); Latch mode		115		135	%
Over load protection	% of maximum lout rated; Hiccup mode			145		%
Short circuit protection			Continuous, automatics recovery			
Remote ON/OFF	External power supply is required Between +Ctrl and -Ctrl	Output ON	0 ~ 0.8 VDC or Open			
		Output OFF	4.5 ~ 12.5 VDC			
		Input current		20		mA
Main output Power Good signal	Referenced to "-Vout"	Power good				Low
		Power off				Open collector
Load Share (-S suffix)	The converter can parallel to increase output current. It has internal load share function in this converter.		Active Droop Current Share Models			
Droop Rate (-S suffix)	No Load to Full Load			4		%
Load Share accuracy (-S suffix)	Full Load			20		%

GENERAL SPECIFICATIONS						
Parameter	Conditions		Min.	Typ.	Max.	Unit
Isolation voltage	1 minute (Reinforced insulation)	Input to Output	3000			VAC
		Input to Base-Plate	2500			
		Output to Base-Plate	1500			
Isolation resistance	500VDC		0.1			G $\Omega$
Switching frequency	230VAC, Full load			180		kHz
Safety approvals(Pending)			IEC/ EN/ UL 62368-1			
Case material			Aluminum base-plate with plastic case			
Potting material			Silicone (UL94 V-0)			
Weight			210g (7.40oz)			
MTBF	MIL-HDBK-217F, Full load		2.500 x 10 <sup>5</sup> hrs			

**ENVIRONMENTAL SPECIFICATIONS**

Parameter	Conditions	Min.	Typ.	Max.	Unit
Operating Base-plate temperature	With derating	-40		+105	°C
Storage temperature range		-55		+125	°C
Over temperature protection	Internal thermistor ; Hiccup mode		115		°C
Operating altitude				5000	m
Thermal shock				MIL-STD-810F	
Shock				MIL-STD-810F	
Vibration				MIL-STD-810F	
Relative humidity				5% to 95% RH	

**EMC SPECIFICATIONS**

Parameter	Conditions	Level
EMI	EN55032 and FCC Part 15 With external components	Conducted
		Radiated
Harmonic currents	EN61000-3-2 Full Load	Class B
Voltage flicker	EN61000-3-3	Class A
EMS	EN55035	
ESD	EN61000-4-2	Perf. Criteria A
Radiated immunity	EN61000-4-3 20 V/m	Perf. Criteria A
Fast transient	EN61000-4-4 ± 2kV With external components	Perf. Criteria A
Surge	EN61000-4-5 DM ± 1kV and CM ± 2kV With external components	Perf. Criteria A
Conducted immunity	EN61000-4-6 10 Vr.m.s	Perf. Criteria A
Power frequency magnetic field	EN61000-4-8 30 A/m	Perf. Criteria A
Dip and interruptions	EN61000-4-11	

**Note:**

1. BASE-PLATE GROUNDING: When connect four screw bolts to shield plane, the EMI could be reduced.

**CAUTION:**

1. This power module is not internally fused. An input line fuse must always be used.
2. The BUS pin only can be connected to capacitor and the components that P-DUKE advised, please do not connect to load and use for any other purpose.

**TYPICAL APPLICATION**

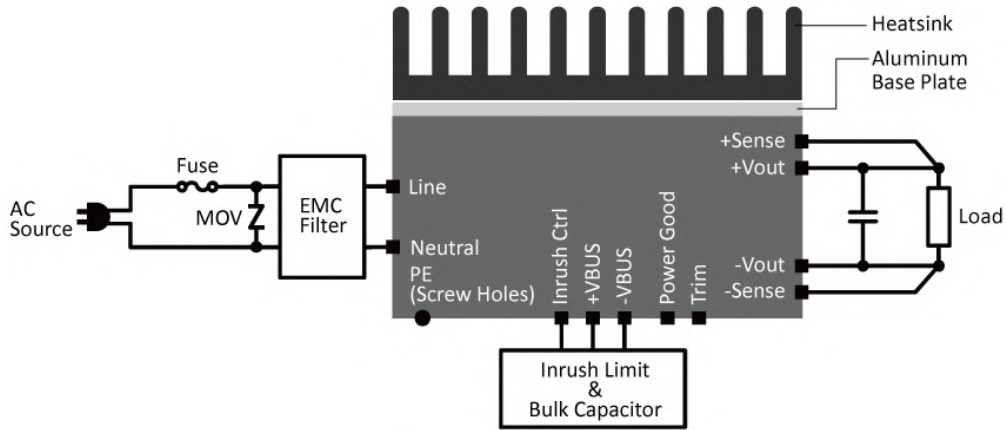

TBF500 Typical Application

**CHARACTERISTIC CURVE**

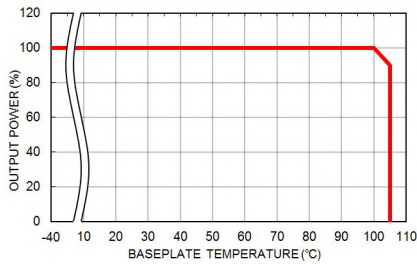

Derating Curve vs. Baseplate Temperature

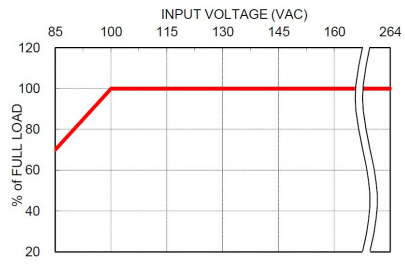

Derating Curve vs. Input Voltage

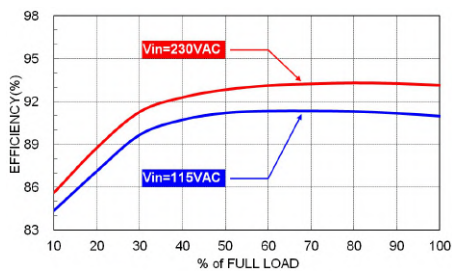

TBF500US24 Efficiency vs. Output Load

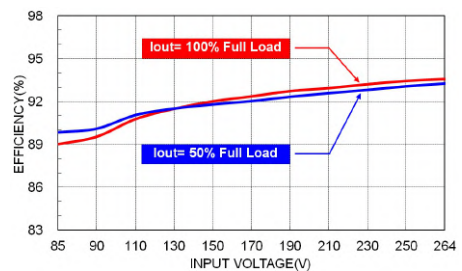

TBF500US24 Efficiency vs. Input Voltage

## MECHANICAL DRAWING

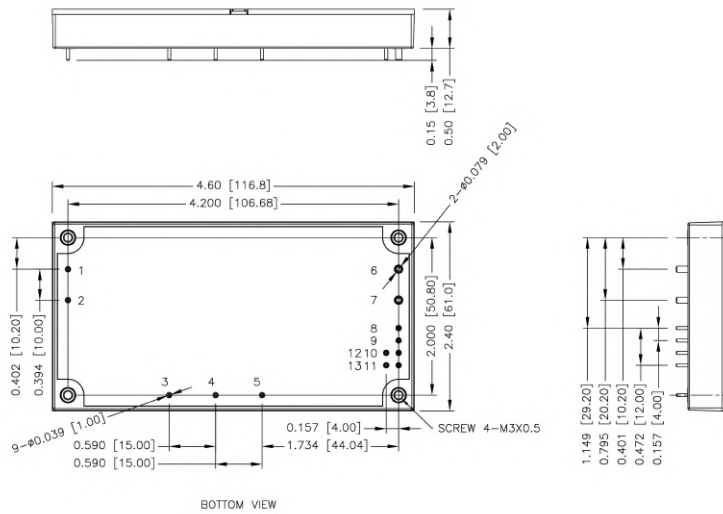

### PIN CONNECTION

PIN	DEFINE
1	AC Input (Neutral)
2	AC Input (Line)
3	Inrush Control
4	+VBUS
5	-VBUS
6	-Vout
7	+Vout
8	-V Sense
9	+V Sense
10	Trim
11	PG
12	+Ctrl
13	-Ctrl

- All dimensions in inch [mm]  
Tolerance : x.xx±0.02 [x.x±0.5]  
x.xxx±0.010 [x.xx±0.25]
- The screw locked torque: MAX 6.6Kgf-cm/0.65N-m

NOTE: Baseplate can be connected to FG through M3 mounting screw holes.

## RECOMMENDED PAD LAYOUT

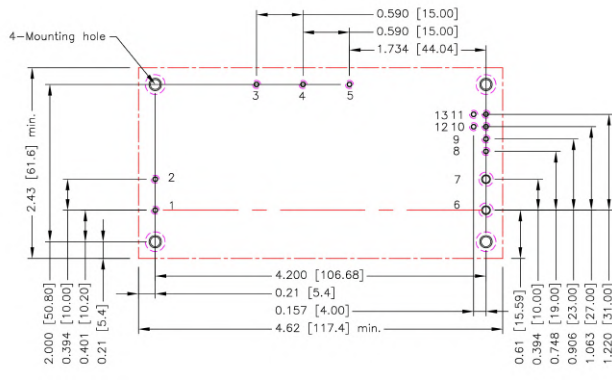

- All dimensions in inch[mm]
- Pad size(lead free recommended)
- Through hole 1.2.3.4.5.8.9.10.11.12.13:  $\phi$ 0.051[1.30]
  - Through hole 6.7:  $\phi$ 0.091[2.30]
  - Through hole of mounting:  $\phi$ 0.126[3.20]
  - Top view pad 1.2.3.4.5.8.9.10.11.12.13:  $\phi$ 0.064[1.63]
  - Top view pad 6.7:  $\phi$ 0.113[2.88]
  - Top view pad of mounting:  $\phi$ 0.157[4.00]
  - Bottom view pad 1.2.3.4.5.8.9.10.11.12.13:  $\phi$ 0.102[2.60]
  - Bottom view pad 6.7:  $\phi$ 0.181[4.60]
  - Bottom view pad of mounting:  $\phi$ 0.252[6.40]

## OUTPUT VOLTAGE ADJUSTMENT

Output voltage is adjustable for 10% trim up or -10% trim down of nominal output voltage by connecting an external resistor between the Trim pin and either the +Sense or -Sense pins.

With an external resistor between the Trim and +Sense pin, the output voltage set point decreases.

With an external resistor between the Trim and -Sense pin, the output voltage set point increases.

Maximum output deviation is +10% inclusive of remote sense.

The external TRIM resistor needs to be at least 1/8W of rated power.

### Trim Up Equation

$$R_U = \left[ \frac{G \times L}{(V_{o,up} - L - K)} - H \right] \Omega$$

### Trim Down Equation

$$R_D = \left[ \frac{(V_{o,down} - L) \times G}{(V_o - V_{o,down})} - H \right] \Omega$$

### Trim Constants

Module	G	H	K	L
TBF500US12	51000	2000	9.5	2.5
TBF500US15	51000	2000	12.5	2.5
TBF500US24	120000	2000	21.5	2.5
TBF500US28	140000	2000	25.5	2.5
TBF500US48	240000	2000	45.5	2.5
TBF500US54	300000	2000	51.5	2.5

## EXTERNAL OUTPUT TRIMMING

Output can be externally trimmed by using the method shown below.

Trim-up

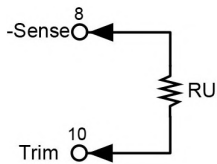

### US12

$\Delta V$ (%)	1	2	3	4	5	6	7	8	9	10
Vout (V)	12.12	12.24	12.36	12.48	12.60	12.72	12.84	12.96	13.08	13.20
RU (k $\Omega$ )	1060.500	529.250	352.167	263.625	210.500	175.083	149.786	130.813	116.056	104.250

### US15

$\Delta V$ (%)	1	2	3	4	5	6	7	8	9	10
Vout (V)	15.15	15.30	15.45	15.60	15.75	15.90	16.05	16.20	16.35	16.50
RU (k $\Omega$ )	848.000	423.000	281.333	210.500	168.000	139.667	119.429	104.250	92.444	83.000

### US24

$\Delta V$ (%)	1	2	3	4	5	6	7	8	9	10
Vout (V)	24.24	24.48	24.72	24.96	25.20	25.44	25.68	25.92	26.16	26.40
RU (k $\Omega$ )	1248.000	623.000	414.667	310.500	248.000	206.333	176.571	154.250	136.889	123.000

### US28

$\Delta V$ (%)	1	2	3	4	5	6	7	8	9	10
Vout (V)	28.28	28.56	28.84	29.12	29.40	29.68	29.96	30.24	30.52	30.80
RU (k $\Omega$ )	1248.000	623.000	414.667	310.500	248.000	206.333	176.571	154.250	136.889	123.000

### US48

$\Delta V$ (%)	1	2	3	4	5	6	7	8	9	10
Vout (V)	48.48	48.96	49.44	49.92	50.40	50.88	51.36	51.84	52.32	52.80
RU (k $\Omega$ )	1248.000	623.000	414.667	310.500	248.000	206.333	176.571	154.250	136.889	123.000

### US54

$\Delta V$ (%)	1	2	3	4	5	6	7	8	9	10
Vout (V)	54.54	55.08	55.62	56.16	56.7	57.24	57.78	58.32	58.86	59.4
RU (k $\Omega$ )	1386.889	692.444	460.963	345.222	275.778	229.481	196.413	171.611	152.321	136.889

**OUTPUT VOLTAGE ADJUSTMENT(CONTINUED)**

Trim-down

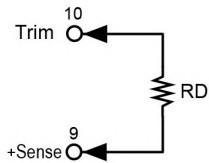
**US12**

$\Delta V$ (%)	1	2	3	4	5	6	7	8	9	10
Vout (V)	11.88	11.76	11.64	11.52	11.4	11.28	11.16	11.04	10.92	10.8
RD (k $\Omega$ )	3984.500	1965.750	1292.833	956.375	754.500	619.917	523.786	451.688	395.611	350.750

**US15**

$\Delta V$ (%)	1	2	3	4	5	6	7	8	9	10
Vout (V)	14.85	14.7	14.55	14.4	14.25	14.1	13.95	13.8	13.65	13.5
RD (k $\Omega$ )	4197.000	2072.000	1363.667	1009.500	797.000	655.333	554.143	478.250	419.222	372.000

**US24**

$\Delta V$ (%)	1	2	3	4	5	6	7	8	9	10
Vout (V)	23.76	23.52	23.28	23.04	22.8	22.56	22.32	22.08	21.84	21.6
RD (k $\Omega$ )	10628.000	5253.000	3461.333	2565.500	2028.000	1669.667	1413.714	1221.750	1072.444	953.000

**US28**

$\Delta V$ (%)	1	2	3	4	5	6	7	8	9	10
Vout (V)	27.72	27.44	27.16	26.88	26.6	26.32	26.04	25.76	25.48	25.2
RD (k $\Omega$ )	12608.000	6233.000	4108.000	3045.500	2408.000	1983.000	1679.429	1451.750	1274.667	1133.000

**US48**

$\Delta V$ (%)	1	2	3	4	5	6	7	8	9	10
Vout (V)	47.52	47.04	46.56	46.08	45.6	45.12	44.64	44.16	43.68	43.2
RD (k $\Omega$ )	22508.000	11133.000	7341.333	5445.500	4308.000	3549.667	3008.000	2601.750	2285.778	2033.000

**US54**

$\Delta V$ (%)	1	2	3	4	5	6	7	8	9	10
Vout (V)	53.46	52.92	52.38	51.84	51.3	50.76	50.22	49.68	49.14	48.6
RD (k $\Omega$ )	28309.111	14003.556	9235.037	6850.778	5420.222	4466.519	3785.302	3274.389	2877.012	2559.111