

01° 2015

mag^o
all about ebm-papst

°19 **Silent heroes:** Patients in a Danish clinic can finally enjoy some peace and quiet.

°22 **Bone dry:** Saving energy whilst drying the laundry.

PERFECT DATA PROTECTION

A compact server room protects sensitive data against fire, water, theft and vandalism — whilst keeping perfectly cool.



WORLDWIDE

“New Energy for the future”

*ebm-papst Benelux B.V.
Polbeemd 7
5741 TP Beek en Donk
Netherlands
Phone: +31 492 502-900
Fax: +31 492 502-950
verkoop@nl.ebmpapst.com
www.ebmpapst.nl*





A calculated strategy for diversity

Thomas Borst

**Managing Director
Sales and Marketing
ebm-papst Group**

Dear reader, This issue of our customer magazine impressively shows the wide range of applications in which ebm-papst products are used – from the ValueShelter protective container, with its combination of safety and air-conditioning technology to a heat pump dryer and a tranquil spa. Is this wide diversity an end in itself or is it just coincidence? The answer is neither. This is the result of a calculated strategy, as a wide diversification gives us stable ground on which to stand. For you as a customer, this creates two main benefits. Firstly, you know you can put your trust in us as a reliable partner and supplier for the long term. Secondly, this wide range of applications creates a huge store of experience that we can call upon in your projects. We can take technology that has proven itself in one market and use it effectively for our customers in others. Last year, this successful technology trans-

fer led to us being chosen by Formula 1 team MERCEDES AMG PETRONAS to support and advise them on energy efficiency.

All our customers benefit from our knowledge in this area. Working together, we are constantly striving to improve. This will be reflected in our product range in 2015. You can also look forward to new aerodynamically optimised solutions, such as new wheel impeller technologies for ventilation and air conditioning that allow for even greater energy savings.

When our company was born, founder Gerhard Sturm made it one of the business' principles that every new product should be more efficient and more environmentally friendly than its predecessor. This model for success has continued to bear fruit to this day. Even at the ripe old age of 80, the company founder still makes sure that we stay true to this principle. I hope you enjoy reading this edition!



26



10



24

01° 2015 mag



14



22



06 ebm-papst 360°

10 PROTECTING YOUR DATA

The robust ValueShelter protects servers carrying sensitive data, even in damp cellars.

14 Old meets new

Wolf's new oil condensing boiler combines a proven combustion principle with GreenTech.

16 Product Poster

18 "We can push the boundaries even further"

Cooling means reliability: We speak to Simon Cole, Chief Track Engineer at MERCEDES AMG PETRONAS.

19 Silent heroes

How a clinic in Denmark finally got quiet, clean air conditioning.

22 Bone dry

A new generation of heat pump dryers uses efficient RadiPac fans.

24 Turn on, tune out

Mollerus' new ventilation blocks help swimmers and spa visitors to relax without disruptive noises.

26 All aboard!

ebm-papst products on trains and trams.

28 tech.talk

29 Service

30 Beyond your nose

31 ebm-papst worldwide



Ergatec AG; ebm-papst/Bernhard Huber; Wolf GmbH; RapidEye/Stockphoto; Isabelle Schichtelzer; ebm-papst



HAPPY BIRTHDAY!

Former German President Horst Köhler congratulates ebm-papst founder Gerhard Sturm on his 80th birthday. This special day was celebrated at an event in the Stauseehalle in Muldingen.

80!

A new, greener home

ebm-papst Benelux integrates GreenTech philosophy in new headquarters.

ebm-papst Benelux is setting new benchmarks for efficiency with its new building near Eindhoven. The new headquarters building has been given the A⁺⁺⁺ efficiency rating. To achieve this rating, ebm-papst used its own products. An air conditioning system, fitted with energy-efficient EC fans of course, ensures optimum room temperature. On summer nights, the Free-Cooling System kicks in. As soon as the outdoor temperature falls below that of the storage hall, the cool air flows into the

building through large fans driven by EC motors. In the kitchen, an extraction hood fitted with an ebm-papst blower keeps the air clean and absorbs strong odours. The large windows ensure that the storage hall is flooded with daylight, largely removing the need for artificial light. The integrated geothermal system converts energy in the ground into useable energy, which is then used to power the underfloor heating in both the offices and the storage hall.

The new headquarters building in the Netherlands is setting new benchmarks with its A⁺⁺⁺ energy efficiency rating.



News in brief

ebm-papst struck gold twice at the **MATERIALI-CA Design + Technology Award** Gold. The energy-saving evaporator fan was honoured in the category "CO₂ Efficiency", with the FlowGrid air inlet grille claiming gold in the "Product" category. The FlowGrid also received a Special Mention from the expert jury at the **German Design Award 2015**. The product was honoured in the Excellent Product Design – Building and Energy category.



At the 5th marconomy B2B Marketing Congress, **Kai Halter, Marketing Director at ebm-papst Mulfingen**, was honoured for his 18 years of service at ebm-papst. In justifying their decision, the jury pointed to how Halter had helped to make ebm-papst a global brand. Kai Halter: "I could never have achieved so much without the backing of such a strong company as ebm-papst and the efforts of my entire marketing team."



At the start of the year, the Bundesliga's top youth teams came together with amateur sides from the Heilbronn-Franken region for the 13th **ebm-papst Indoor Championships**, held in the Gerhard Sturm Halle in Mulfingen. Karlsruhe SC were crowned champions of the A Youth teams, with TSV Crailsheim coming out on top among the amateur sides. For the first time, the tournament was held completely on artificial turf, creating a further technical challenge for the players.



Fotolia / Smileus

SMMT / ebm-papst



Gareth Jones on the night of his nomination as SMMT President, next to his predecessor Tim Abbott

ebm-papst for President!

Managing Director of ebm-papst becomes the new head of the trade association for the UK motor industry.

The Society of Motor Manufacturers and Traders (SMMT), the trade association for the UK motor industry, has named Gareth Jones, Managing Director of ebm-papst Automotives & Drives UK Ltd., as its new President. Jones took up the position on 1 January 2015. "It's a big honour. But I am also filled with great respect when I look at the names of the previous 78 presidents during the 113 year history of the Society," says Jones. "Supporting the development of the Industrial Strategy for the UK automotive sector will be a key part of my role. Addressing the sectors global competitiveness, technology and policy issues as well as boosting supply chain growth and investment are central to that activity. Additionally, given the difficulties we are currently encountering in finding enough skilled workers in the UK, developing a 'skills pipeline' to train more skilled engineers and technicians will be important".

Together with ebm-papst, Jones has been a member of the influential association since 2005 and sat on the Automotive Components Section committee, of which he became chairman in 2010. Two years later, he was appointed as one of five vice-presidents. He is now succeeding Tim Abbott, the managing director of BMW UK as SMMT President. Jones will be supported by six Vice Presidents coming from Ford, Jaguar Land Rover, Nissan, Unipart Group, Toyota and Renault.

"It will of course mean a lot of extra work and bed-time reading for me," says Gareth Jones about his new post – but it is a great opportunity for ebm-papst as well: "In my new position I'm not only representing our customers' interests to government and other stakeholders. I have an excellent insight into the challenges facing vehicle manufacturers as well as their supply chains."

Supporting science

ebm-papst invests 3.5 million in new institute.

ebm-papst has supported the University of Heilbronn for years, both in terms of finance and ideas. The company is now

planning to found a research institute at the campus in Künzelsau. Around 3.5 million euros are to be spent on buildings and equipment as well on professors and lecturers.

The purpose of the institute is to extend research work in the field of electromagnetic drives. Rainer Hundsdörfer, Chairman of the Board of Directors of the ebm-papst Group: "With this investment in science and education we are hoping to strengthen the position of the university and in particular to promote the 'Technology Agenda' in Künzelsau. Research into electromagnetism is of great significance not just to ourselves, but also to many other companies in the area aiming to make products, such as fan drives and motors, ever more efficient."



ebm-papst

The new institute will aim to expand research in the area of electromagnetic drives.



BMBF/Ricke

A WORK OF ART

Minister for Education and Research Johanna Wanka watches a system for creating rainbows at the opening of the new building. The system works thanks to fans from ebm-papst, which create a whirl of water vapour that shimmers in all the colours of the rainbow.

GreenTech worldwide

Making the world a greener place: District heating in Denmark

Environmental awareness is a matter of course for ebm-papst. Just under a year ago our subsidiary in Denmark switched to district heating. This involves using the waste heat produced by the generation of power to supply buildings with hot water and heating. This source of energy offers the advantage of a distinct reduction in CO₂ emissions thanks to the combined generation of heat and electricity, whilst at the same time allowing different types of fuel to be used to obtain the heat.



The district heating system uses thick pipes to bring warmth to homes.

ebm-papst

WWW.GREENTECH.INFO

“We cannot live at the expense of our children”

Horst Köhler, former Federal President of Germany, speaks about his commitment to climate protection, the greatest challenges and positive examples.

What does sustainable growth mean for you?

In short, that our children and grandchildren enjoy the same level of freedom that we do. That is why we cannot live at their expense. This applies just as much to government finances as it does to greenhouse gas emissions.

Why is the issue of sustainability so important to you personally?

I myself have grandchildren and I want them to grow up in a world that gives them freedom and opportunity. I also know that this is only possible if this freedom and opportunity is also available to the grandchildren of a farmer in Malawi. The question of sustainability is a social question as much as an environmental one.

You were recently asked by Ban Ki-moon to cooperate in a UN working group. What was your task there?

I worked with 26 other figures from all over the world in the “High-level Panel on the Post-2015 Development Agenda”. We asked ourselves, which goals global society should aim to achieve by the year 2030. At the centre of this were the two huge challenges of ending extreme poverty and preserving the planet’s natural ability to support life. We agreed that this required far-reaching changes in the way companies do business and consumers behave. Developed nations must lead the way here with technical innovation and political ambition.

Where do you see the greatest challenges on the road to sustainably growth?

Our economy is far too dependent on cheap fossil fuels. If we cannot break this addiction, massive global warming with dangerous consequences for all of humanity will become inevitable. I am worried that the sudden falls in the price of oil risks setting our efforts back. This is why I believe the time is right for a global tax on greenhouse gas emissions.

Has progress been made here?

People are much more aware of global connections now. The internet has certainly played a role here. More and more businesses are realising that

sustainability is not a “nice to have”, but is of key importance to their own interests. The road from realisation to practice is a rocky one, of course, but there are plenty of inspiring examples – just look at the innovations of ebm-papst.

Are there things that individuals can do?

Our everyday lives are full of decisions that have an influence on global development. Car or train? Meat or vegetables? Lightbulb or LED? Every person can educate themselves more about how our consumer behaviour can help create a life where there is dignity for all and where the planet is healthy. ○

Horst Köhler, former Federal President of Germany, has a strong commitment for climate protection.

ebm-papst/KD Busch







Protecting your data

Compact, protected against fire and break-ins and with excellent air conditioning – the ValueShelter protects servers holding sensitive data. But the hardware's energy-efficient cooling really comes into its own in a cold and damp cellar.

When you think of processing centres, you normally think of large rooms stretching across row upon row of big grey boxes in which data is processed, forming the backbone of our digital society. But the amount of space being used in these rooms has actually shrunk in recent years, as hardware becomes ever more compact and servers become virtual. What is left are large rooms with a lot of space, with huge amounts of air being moved around and cooled – in other words a waste of energy. "This was exactly what got us thinking about alternatives to common processing centres in large rooms", explains Erwin Gasser, CEO of Swiss company Ergatec. The result of their brainstorming is the ValueShelter, a two meter-wide and two metre-high container that offers enough space for a standard 19-inch rack, into which active IT components can be inserted.

The data box in the cellar Alongside protection against theft, fire, vandalism, sabotage and other environmental threats, one of the major challenges in developing the compact protective space was perfect air conditioning. "For components in information and communication technology (ICT) in particular, it is especially important that we have a closed circuit that no outside air with corrosive particles can penetrate"; says Gasser. That is why, together with his son Michael, he developed an air conditioning module with two separate air circuits. A large customer in Bern presented the

The ValueShelter works especially well in cold and moist cellars, thanks to its special air conditioning module. The product is the brainchild of Michael and Erwin Gasser from Ergatec, with the help of Daniel Spurgeon from ebm-papst.

ebm-papst / Isabelle Schönholzer, istockphoto/herraez

“We benefit from the excellent power consumption level of the fans in partial load mode.”

Michael Gasser, IT Construction Engineer, Ergatec AG



ideal conditions for the ValueShelter to be used. Working together with Ergatec, the customer chose a 160-year old rock cellar in the city to house its secure server. The average temperature here is ten degrees Celsius, with a relative humidity of around 90 percent. This is probably the last place where you would want to put your computer. But the ValueShelter’s special air conditioning module exploits the cold and moist air by turning the internal energy of the air into cooling energy.

Closed circuit The ValueShelter works especially well in cold and moist cellars, thanks to its special air conditioning module. The product is the brainchild of Michael and Erwin Gasser from Ergatec, with the help of Daniel Spurgeon from ebm-papst. Air is sucked in by fans in the outer circuit, creating cold water. This is used in the inner heat exchanger to create cool circulatory air for the inner air conditioning circuit. The inner and outer circuits are completely separated from each other. In order to keep the system as efficient as possible, Ergatec went on the search for compact and efficient fans. They contacted a range of manufacturers looking for suitable products. “ebm-papst called us back right away and said they wanted to take a closer look at the project with us”, explains Michael Gasser. He got in touch with Daniel Spurgeon, Area Sales Manager at Swiss subsidiary ebm-papst AG and went through the precise specifications with him. Spurgeon suggested using EC axial fans with sickle-shaped blades. As it turned out, the installation situation meant that it would be better from an energy perspective to fit two fans at each inlet and outlet instead of one. “Thanks to this redundancy and the associated larger openings, the individual fans do not have to produce as much pressure, resulting in a lower energy requirement”, says Spurgeon. “In theory, you could go for a larger fan. But in this installation situation, two smaller products were a better fit.”

The good conditions in the cellar and the use of EC axial fans make the ValueShelter especially efficient. Heat dissipation of the hardware components is 7,000 watts. The system requires only 300 watts to ensure the air conditioning of the ICT equipment. This ratio of total power consumption and that of the ICT equipment results in a very good PUE value* of 1.04. It is even possible to improve this value if the heat created in the outer heat exchanger (heater) is used by connecting a heat pump or boiler.

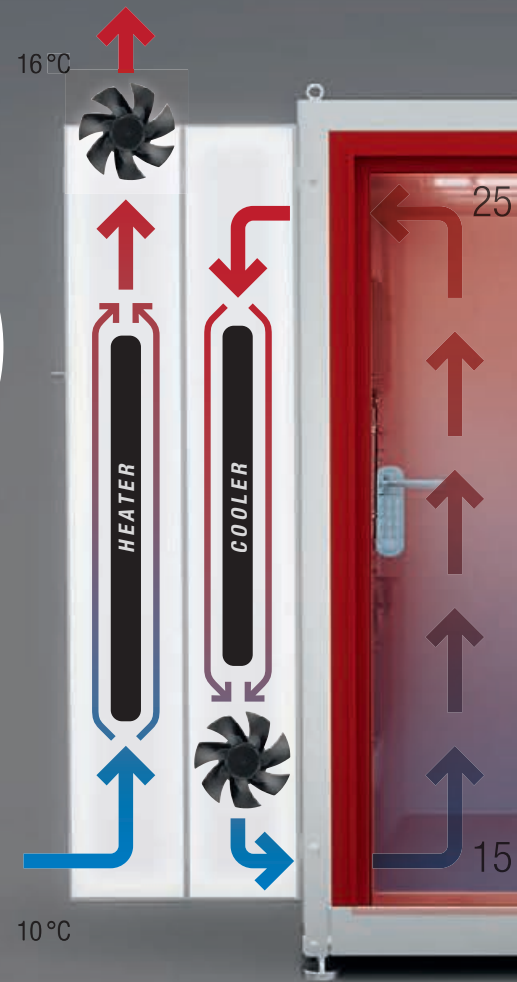

The air conditioning module for moist areas

Outside air with a low temperature and high relative humidity flows through the outer part of the air conditioning module into the first heat exchanger (heater), where it is blown back into the room by ebm-papst fans mounted on the top side. This creates cold water, which then flows through the inner part of the air-conditioning module to the second heat exchanger (cooler) and cools the circulated warm air coming from inside the ValueShelter.

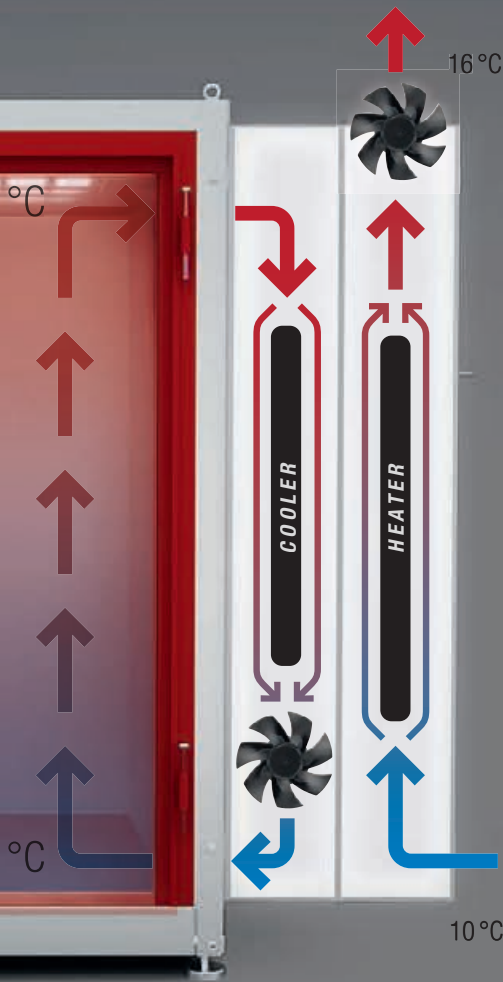

“Thanks to this redundancy, fans do not have to produce as much pressure, resulting in a lower energy requirement.”



Daniel Spurgeon, Area Sales Manager, ebm-papst AG

Prepared for emergencies The ValueShelter works especially well in cold and moist cellars, thanks to its special air conditioning module. The product is the brainchild of Michael and Erwin Gasser from Ergatec, with the help of Daniel Spurgeon from ebm-papst. To protect the air conditioning system against failure, each ValueShelter has two air conditioning modules attached. “We use both modules during normal operation according to requirements. We benefit here from the excellent power consumption level of the ebm-papst fans in partial load mode”, says Michael Gasser. If one module fails, the other can assume 100 percent of the load and operation is not interrupted.

“I think we will see significantly increased demand for the ValueShelter in the coming years.”



Erwin Gasser, CEO, Ergatec AG

The ValueShelter is also well protected against other negative external influences. The fire protection is unique for a server container of this size. As soon as a fire breaks out, the container seals itself off against heat and corrosive combustion gases by means of fire protection slide valves. The valves are closed via a so-called spring return actuator that closes the air inlets and outlets without the need for electricity. “We had the fire protection slide valves patented in the EU and the USA, as we needed to develop them in this size if we ever wanted to make the ValueShelter reality”, explains Erwin Gasser. He is proud of the fact that, together with his son, he was able to put several ideas into action that at the start sounded unusual. This is why he is positive about the future of the ValueShelter. “Maybe our product is a little ahead of its time. I think we will see significantly increased demand in the coming years. Things like data protection laws, data security and energy efficiency are becoming more important, and we stand to gain from that.” ○



The redundant air conditioning module ensures that the ValueShelter is always kept cool.

Ergatec AG; ebm-papst/Isabelle Schönholzner; Illustration: Gernot Walter

* The PUE value (PUE: Power Usage Effectiveness) is calculated from the quotient of the total power consumption divided by the power consumption of the ICT equipment. It helps show how efficient energy is used in a processing centre.

The compressed atomisation ensures perfect oil combustion in Wolf's oil condensing boiler.



Wolf GmbH

“With the BG 43, we were able to go to the limits of the system in terms of speed. Even at 300 rpm it remains stable.”

Matthias Herbst, Development Project Manager at Wolf GmbH

Old meets new

When creating a new oil condensing boiler, the company Wolf GmbH combined a proven combustion principle with technology from ebm-papst. The result was an efficient heater.

In Germany alone, around 5.6 million oil heaters help keep homes warm. Not only do they burn precious fossil fuels, but they also consume huge amounts of electricity. This means that both manufacturers and customers are looking for ever more efficient solutions. One of them is Matthias Herbst from Wolf GmbH. The company, based in the Bavarian town of Mainburg, is one of the leading providers of air conditioning and heating technology. Its COB oil condensing boiler came out on top in a test by German consumer organisation Stiftung Warentest and Herbst, who is a project manager in the development team, wanted to improve it further. Just like its gas-powered counterpart, it uses the energy from the water vapour arising from the combustion, which otherwise would just go up the chimney and be wasted. "In order to reduce the oil and energy consumption even further, we wanted to make it possible for consumers to modulate the boiler", says Herbst of the challenge. This allows the boiler to flexibly adjust its power to the actual heating requirements. "In the end, we changed the combustion technology so much that it had to be considered as a completely new development." This development has been on the market since spring 2014 under the designation TOB and promises single and multiple-occupancy houses energy-efficient housing with low levels of hazardous substances. Compared to its two-stage predecessor, the new oil condensing boiler can be operated with modulated power between 6.6 and 18.6 kilowatts.

Spray mist with the ideal angle This is exactly where the problem lay in development. In order to enable flexible modulation, other manufacturers pre-heat the oil and combust the vapour this creates like gas. The disadvantage of this is that the oil evaporation process is extremely energy intensive. For the developers at Wolf then, this technology did not even come into question. They preferred to use compressed atomisation for combustion, technology that they have been using for over twenty years. "We wanted to retain this proven method", explains Herbst. In compressed

atomisation, a pump compresses oil at high pressure through a nozzle, resulting in a spray mist of tiny droplets. This then combusts with the air that is fed in. This process is most efficient when the spray mist has the given spray angle of the nozzle. This is no problem at the higher power levels. At lower levels, it is more difficult. If the pressure falls below a certain level, the spray angle collapses and the droplets are no longer so fine. This cannot be allowed to happen however, if the unit is to remain adjustable. This meant that the limits of the atomisation process had to be expanded. The engineers at Wolf GmbH therefore developed a special air nozzle. It gives the air (and therefore the spray mist) the push it needs to create the classic spray mist with fine droplets, even at low pressure. The only difficulty now was finding the right pump. "We needed a pump that would cover the range between 3.5 and 23 bar, as well as the right motor to ensure everything ran stably. It wasn't so easy", Herbst explains. The motor needed to be able to deal with low and high speeds, as well as fluctuating torques.

From blower to motor This is where ebm-papst came in. Just like in the COB, the TOB was also to be fitted with a blower from Landshut to control the air flow. In one of the discussions focussing solely on these components, Stefan Obermaier from the sales department at ebm-papst heard about the problems surrounding the pump and finding a suitable motor: "Our BG 43 EC motor immediately sprang to mind." The drive motor is suitable for many different applications, although it had never before been used in oil pumps. The decision was, however, quickly taken to try out the efficient all-rounder. "With the BG 43, we were able to go to the limits of the system in terms of speed. Even at 300 rpm it remains stable", says Herbst of the advantages and continues: "It also operates very efficiently, just like the blower." The engineers adapted the BG 43 further for this application, disconnecting the circuit board for the control to enable a modular design. ○

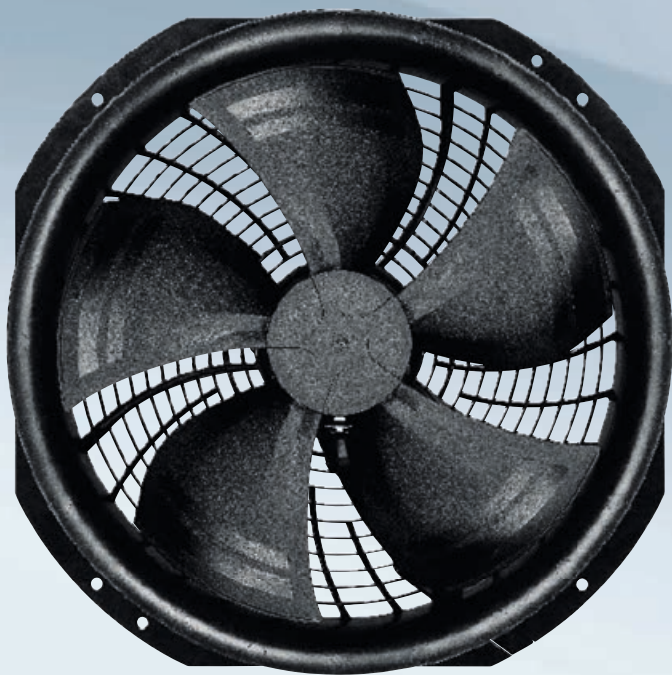

THE FLOW MACHINE The reengineered Plug & Play centrifugal fans for ventilation technology easily meet the latest requirements for controllability and efficiency. The RadiPac series even goes well beyond the requirements of regulations like the EnEV and ErP Directive. The motors have been made almost as efficient as possible, so the latest improvements centre on the air inlet, the position of the motor in the impeller and the blade profile.

www.ebmpapst.com/flow_machine

KEEPING COOL ON THE GO The compact W1G300 EC axial fan is perfect for air conditioning systems in commercial vehicles and buses. It can take everything a journey can throw at it. Whether it's 85-degree heat, monsoon rain or jets of steam, it will withstand anything. It may be tough, but it's also gentle, with the soft start function sparing the on-board electrical system.

www.ebmpapst.com/keeping_cool



HAVE YOU GOT A SIZE LARGER? With the ECI80, ebm-papst is expanding its range of compact drives for automation with a nominal drive output of 750 watts. Previously, the ECI modular system provided outputs of between 30 and 400 watts. This family of motors allows users to combine drives, control electronics, gearboxes, brake and sensor modules to fit their needs, and is now available in an 80 millimetre version.

www.ebmpapst.com/size_larger

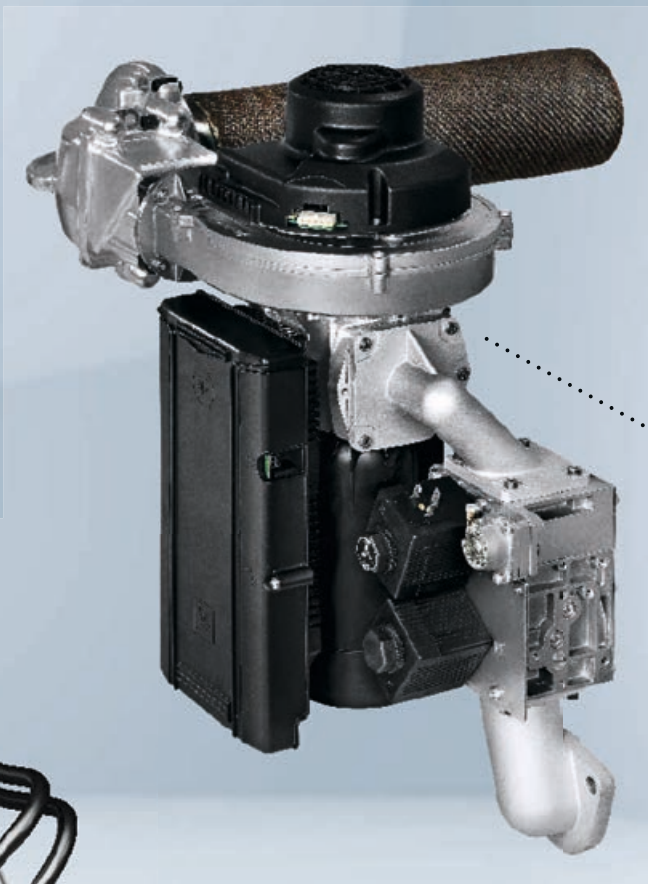

POCKET-SIZED POWER

The 150-kilowatt gas/air mixture is a complete solution, consisting of a venturi, blower, burner control, valve and burner. It crams a lot of power into a compact package. With it, users can create wall-mounted gas condensing boilers.

www.ebmpapst.com/large_power

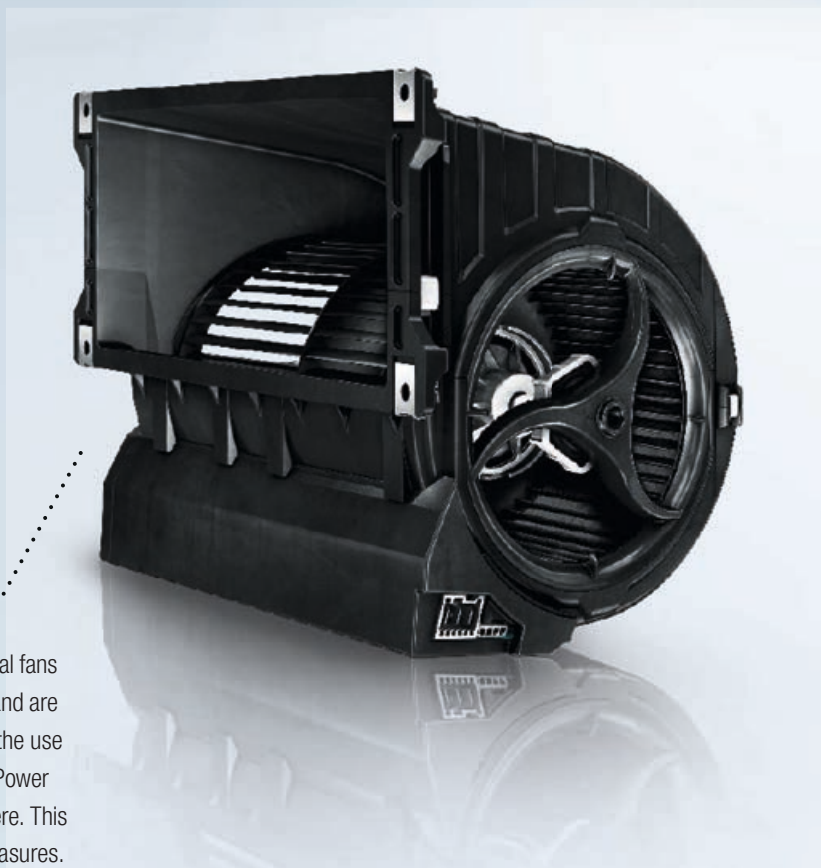

THE PROBLEM SOLVER GreenTech EC centrifugal fans work at high levels of efficiency, use up to 70 percent less energy and are extremely quiet. They are now also solving problems surrounding the use of multiple fans connected in parallel. The newly developed active Power Factor Correction (PFC) filters the disruptive harmonics that arise here. This allows users to maintain the required values without additional measures.

www.ebmpapst.com/problem_solver

“We can push the limit a bit more”

Chief Track Engineer Simon Cole of the MERCEDES AMG PETRONAS Formula One Team on the importance of cooling for race car and team.

What's ebm-papst's contribution to your success?

ebm-papst supports us with all the ancillary cooling infrastructure that we need to run the car. The car is a device that generates an enormous amount of power and it can only run in a very constrained range of temperature. So we need cooling solutions for the side-pod and for the roll-hoop. We need cooling of all the electrical boxes because the moment the car stops in the garage we have to cool it by other means than its own speed. We need to ventilate the garage to ensure the reliability of the IT systems, computer racking, radio systems. They are all high-power electrical devices that need careful management if they are to be reliable through the race, especially when we go to very challenging countries like Singapore, Abu Dhabi or Bahrain.

So it's not a matter of fractions of seconds during the race.

No, it's more a reliability aspect. We can only run the car if we have complete control of all the temperatures in the whole environment of the car while it's in the garage. On the track we manage that with the car's speed. If we have good control of the temperatures in the garage, we can push the limit a bit more when we're on the track.

We were talking about the cooling car.

What about the people in the team?

It is a very important aspect to achieving the best human performance for the drivers and for all the team members. Most of them have the luxury of not needing to wear fireproof overalls most of the time. But it's still very stressful and extremely tiring if we are doing five days of work in an un-air-conditioned garage in Kuala Lumpur. And if people get tired they make mistakes.

On the race track speed is everything.

What's the importance of speed in developing the car?

It's almost more important than the speed on the race track. The race in which we can develop the car is our number one focus. It's all about getting the design changes designed, made, tested, implemented and onto the car as fast as possible. All areas of the company are obsessed with time – particularly over the winter when we develop a completely new car. The majority of the people that are working in Brackley and Bricksorth are working in some way on developing the car rather than just assembling or manufacturing.

How do details affect your work?

95 percent of the car parts are redesigned every year. A lot of work is done in manufacturing the new car. So we spend half the year trying to make sure that next year's car is a success. And the following six months we spend trying to improve what we've made. We practically never have the same car specification from one week to the next because every week parts of it change. And by the end of the year nearly all of it will have changed.

How does ebm-papst contribute to the next season?

What we have coming for the upcoming season is a completely new garage infrastructure to support the car and the crew. ebm-papst will play a large part in that. We are very keen that everything will be repackaged, redesigned and re-housed. We need to look again at all the cooling solutions. This is a job we will completely redo with ebm-papst. ○



Simon Cole, Chief Track Engineer of the MERCEDES AMG PETRONAS Formula One Team.

MERCEDESAMGPETRONAS

Working on a retrofit job, ebm-papst replaced 167 outdated power guzzling fans by energy saving EC fans at the Odense University Hospital. By chance a new project developed concerning noise instead of energy.



Silent heroes

A hospital in Denmark suffered for years from noise and a room climate that was hazardous to health. The solution came in the form of EC fans.

The plight began six years ago with the installation of a new ventilation system. The noise that this system generated was conveyed through the ventilation ducts into all rooms of the psychiatry ward at the university hospital in the Danish city of Odense. It was noisy in the building, the installation company disappeared and simply refused to do anything about it. Jørgen Søfeldt is a Function Manager at the clinic. He recalls: "The situation was so bad, we had to significantly curb the motor for the ventilation to make the noise level halfway tolerable." Torben Lintrup Kirkholt, Managing Director of ebm-pa-

pst Denmark, describes the situation: "There was still an audible rumbling throughout the building, like a clothes dryer full of tennis balls." That was bad for the patients, who are often particularly sensitive to noise. But there was worse to come.

Cheap fans cause headaches and tiredness "The ventilation system was only running at 60 percent capacity. That meant that the air exchange rate and the air flow needed for a healthy interior climate were nowhere near achieved", reports Kirkholt. "Therefore it was too hot in the building, the CO₂ concentration



ebm-papst

Jørgen Søfeldt, Function Manager at the University Clinic in Odense, is pleased with the silent fans: "Before the renovation, we could only run the ventilation system at 60 percent capacity. The noise was just unbearable."

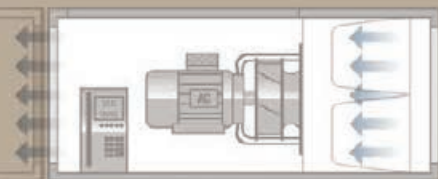

← **BEFORE: Conventional AC fan with variable speed drive.**

→ **AFTER: The energy-saving, virtually silent RadiPac EC fans even require less to install.**

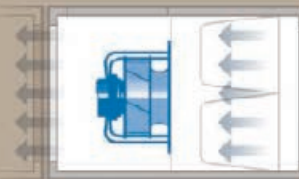

Twenty RadiPac EC fans replace the relatively new AC fans that were causing a racket in the psychiatric ward.

in the air was much too high and it was so humid that mould formed in the corners, all the ingredients for sick building syndrome." The humid room climate and the mould threatened the health of both doctors and patients. Ambient air with a high CO₂ content also leads to tiredness, loss of concentration, headaches and dizziness. Opening the windows for some fresh air was not an option for the psychiatric ward, as they could not be opened for safety reasons. Stuffy, humid and loud – not the ideal environment for patients who should be able to rest in peace and quiet.

"The system was making a noise like a clothes dryer full of tennis balls."

Torben Lintrup Kirkholt, Managing Director of ebm-papst Denmark

A simple solution The solution came as a bit of a coincidence. Søfeldt reports: "In other parts of the university hospital building like the kitchen and laundry, we had had energy-saving fans installed by ebm-papst. When I described our noise problems in the psychiatric ward in

passing to the ebm-papst staff, they said they might be able to help." ebm-papst replaced one of the old fans as a trial. Kirkholt explains: "They were only about six years old, but used 1980's technology: a poor AC electric motor with a cheap frequency inverter and an impeller made from low-grade sheet metal. These three things together caused the noise problems. You could tell right away that the company that had installed these were only interested in fitting the cheapest devices possible." Everything was fine with the RadiPac EC centrifugal fan which was installed. Søfeldt was surprised: "We had no idea that it was just the old fans that were causing the noise!"

Better climate, lower costs The decision was an easy one: all twenty of the old fans had to be removed and replaced by the EC centrifugal fans. ebm-papst completed the job in a week. The system now runs at full capacity and the climate in the room is perfect. And importantly, no noise. The icing on the cake is the amount of energy saved. Thanks to the EC fans, the psychiatric clinic now saves around 5,650 euros on its annual electricity bill. The fans will have paid for themselves in just seven years. ○

“Numbers alone say nothing”

The level of noise emissions is a decisive quality factor for fans. Dr Marc Schneider, ebm-papst's Group Leader for Acoustics, explains how the company keeps its products quiet.

At what point is fan noise perceived as disturbing?

That is not an easy question to answer. There are of course physical characteristics like the noise level that you can measure on a test bench. But numbers alone often say nothing about how the human ear perceives this kind of noise. For a subjective assessment, what is important is how “raw” the noise is perceived. This perception can happen when the signal is given a temporal structure through a change in the frequency or amplitude. A lot of noises also have tonal compo-

ponents which can be extremely disturbing. This perception differs from person to person, which makes assessment even more complicated. One person reacts negatively to low-frequency noises, another winces at higher-frequency noises.

How do you measure this personal perception?

At ebm-papst, we have the “AudiMax”, a so-called psychoacoustic laboratory. In this noise-insulated facility, we have space for up to eight test listeners to whom we can play the noises of

our products in different configurations.

How does this method help achieve usable results?

After hearing the noises, our staff ask the test subjects about how they perceived them and thus create a database with scientific considerations. Using this database, we can evaluate together with our colleagues from production which measures need to be taken and which not. Our overall aim is to create a fan that is perceived as comfortable by as wide a spectrum of test subjects as possible.

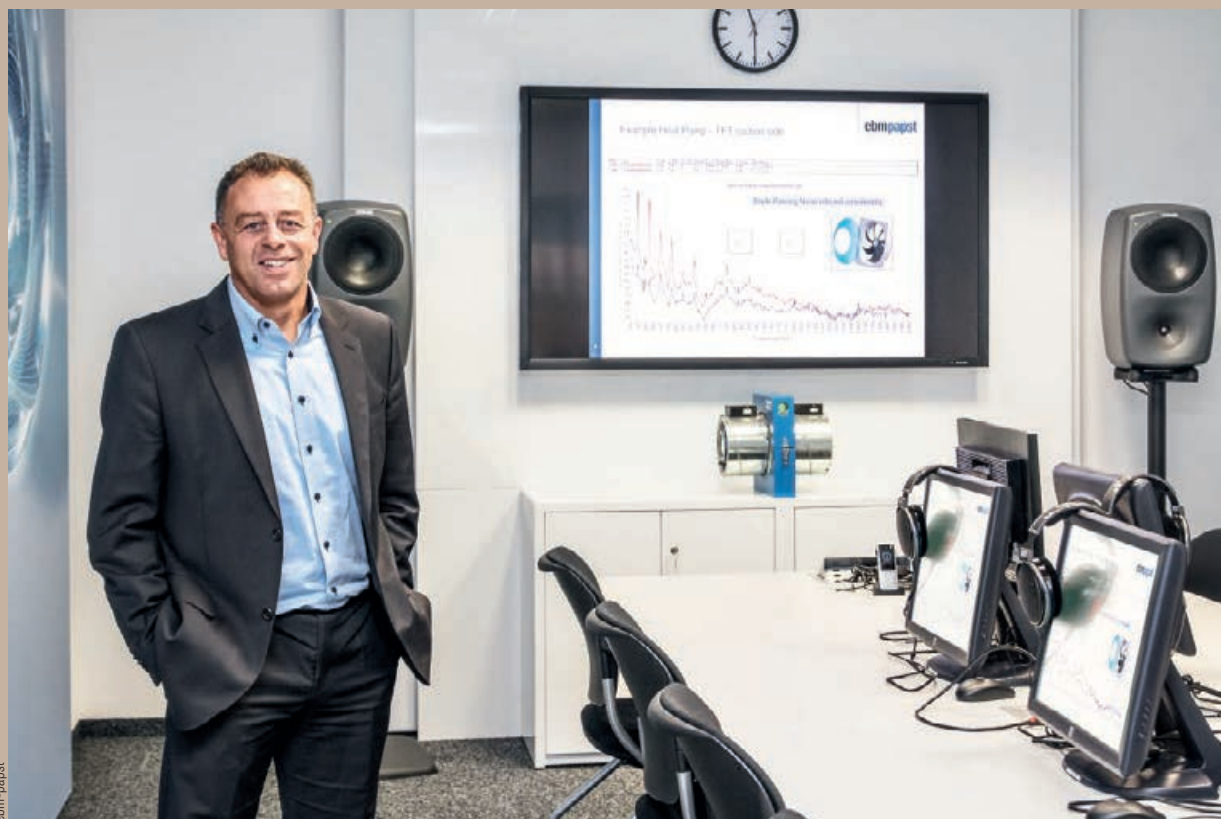

In ebm-papst's psychoacoustic laboratory Dr Marc Schneider searches for fans with pleasant sound.

Bone dry

The new heat pump dryers from Primus save over 60 percent of the primary energy compared to their predecessors. A RadiPac from ebm-papst does its bit here to ensure energy efficiency.

Companies that claim to “care about the environment” in their advertising should back this up with real action. Primus, a major manufacturer of industrial washing machines, finishers and dryers with production based in the Czech Republic, put this motto into practice. The new “T-HP” generation of heat pump laundry dryers saves around two thirds of the primary energy compared to previous models. This is an important sales argument for operators of laundrettes or self-service laundrettes, as energy costs make up a large proportion of the operating costs here.

One of the companies impressed by Primus’s appliances was Firbitex GmbH. The family-owned company from Munich runs twelve laundrettes under the “City Dry Clean” brand. The cleaning specialist is gradually upgrading its laundrettes to Primus dryers and washing machines. Ten have already been upgraded with the remaining two due to follow in 2015. Director of Operations Mario Leitner: “The devices’ potential for saving energy and lowering costs is clear to see.” He was also convinced by the machines’ reliability.

The new generation of heat pump dryers in Firbitex’s Munich laundrettes, fitted with the efficient RadiPac.



Firbitex was therefore ready for a European premiere. The City Dry Clean laundrette in Munich's Karlstrasse now has nine type "T13-HP" heat pump dryers being used every day, the first to be fitted in a self-service laundrette. Each dryer has a drum volume of 285 litres and can hold 13 kilograms of laundry. The fan drive provides 0.2 kilowatts of power, with the drum motor providing 0.25 kilowatts.

The new dryer design, which Primus calls EVO4 technology, is based on performing the drying process in a closed system, the use of a heat pump and energy-efficient EC fan and a low connected load of less than four kilowatt hours at 16 amps. Petr Opavsky, chief engineer at Primus: "In standard dryers, the connected load is generally between ten and 25 kilowatt hours, which is significantly higher than our appliance." In addition to the low consumption values, Primus achieves savings by removing the unnecessary extraction installation and not using a large electrical connection. When

looking for the right fan components, Primus found what they were looking for in ebm-papst.

The specifications made some tough requirements. In addition to a high humidity protection class, temperature resistance up to 60 degrees Celsius and an air flow of at least 800 cubic metres per hour at 750 pascals of pressure increase were needed.

ebm-papst had the right fan for the job in the shape of a 250-millimetre, medium-pressure RadiPac centrifugal fan with a power consumption of 490 watts. A test installation in 150 machines of the previous series proved its suitability. Petr Opavsky from Primus verifies: "The use of EC technology was a premiere for us. The fans passed the test with flying colours." In addition, the installed RadiPac with the efficiency class 71 also exceeds the specifications of the ErP Directive for 2015. ○





Turn on, tune out

From swimming pools to spas, air conditioning systems from Mollerus allow both guests and operators to relax. The devices fit the needs of both perfectly.

Let's leave the world of technology behind us for a moment and take a relaxing break at a spa. Here at the edge of the swimming pool, it is warm and cosy. The water invites you to take a dip and fall off the planet. Simply lay back and enjoy the soft sound of the waves lapping against the edge of the pool. Take a deep breath and relax ...

Ok, that's as far as this text can go without talking about fans, so back to business. That's because the GreenTech EC technology from ebm-papst plays a decisive role in many swimming pools around the world in creating a comfortable and tranquil relaxation experience. It ensures the right temperature and extracts unwanted humidity. Ridvan Cehic is Managing Director of Mollerus GmbH, a company with just 13 staff based in Meersburg on the banks of Lake Constance, and knows how important the benefits

of EC technology are for his sector. "We specialise in systems for hotels and private users", he says. "Here, we supply fully automatic ventilation blocks that are completely tailored to the needs of swimming pools." His devices take all the necessary measurements in the room that are required to regulate the air supply and extraction via the continuous, speed-variable fans. The ventilation blocks control the temperature using heat recovery, with the system removing humidity using outside air or a heat pump, depending on the installation situation.

An oasis of tranquillity in the spa

Mollerus' devices are all produced for continuous operation. They have to run for at least five hours per day to create the right climate conditions. The running time also depends upon how long the pool or spa is open, for example, as well as whether

the pool is covered or not. To allow guests in search of relaxation to enjoy the pool in comfort, disruptive noises must be prevented at all times. "We listened very closely when selecting the fans", says Cehic. "We came to the conclusion that using multiple smaller fans in our units would generate less noise than a large fan of the same output." Aside from a few exceptional cases, no additional noise reduction measures were required – a clear cost advantage. The second advantage of this decision was that Mollerus could offer its ventilation blocks as modular systems, with up to eight energy-saving GreenTech EC fans. "This means we can provide our customers with precisely the right unit for any size of room", says Cehic. The EC blowers designed for Mollerus run quietly, ensuring a relaxing atmosphere and allowing spa guests to enjoy their visit. ○

Relaxation without disruptive noises: The ventilation blocks from Mollerus use GreenTech EC technology.

ALL ABOARD!

Every day, trains, trams and subways help people around the world get to work, meet friends or go on holiday. Passengers on these modes of transport expect comfortable travel experiences and safe transit. ebm-papst is making an important contribution to this with its durable, robust and reliable components. All products meet the requirements unique to rail transport, such as continued functionality in the event of shocks and vibrations, noise reduction and IP protection.



WINDSCREEN WIPER

There isn't much space on the front window of a train to fit a windscreen wiper. At the same time, it also has to generate high torques. These requirements are fulfilled with an extremely durable and compact angular geared motor. It is configured to between 1.2 and 2.4 million movement cycles.

CONVERTER COOLING

Converters change the high voltage in the overhead lines so that it can be used for the various loads in the train. As this conversion generates heat, the converter needs to be cooled. This task is generally performed by centrifugal fans.





DOOR DRIVES

A variety of door drives allow train doors to glide open and closed smoothly and quickly, as every second counts in rail transport. Depending on the requirement, these drives use planetary gears, combinations of planetary gears with angular gears or special gears.

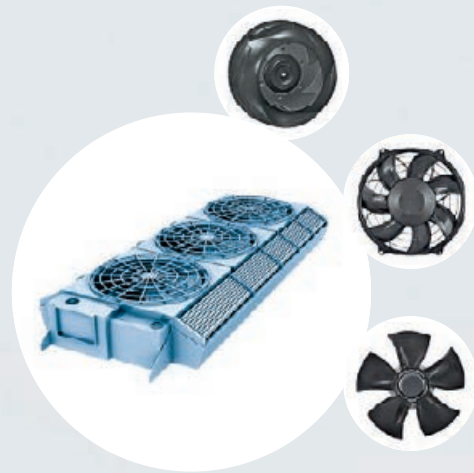

AIR CONDITIONING

To ensure that the driver and passengers arrive at their destinations in comfort, the driver's cabin and passenger carriages are air conditioned. The air is conveyed by axial and centrifugal fans.

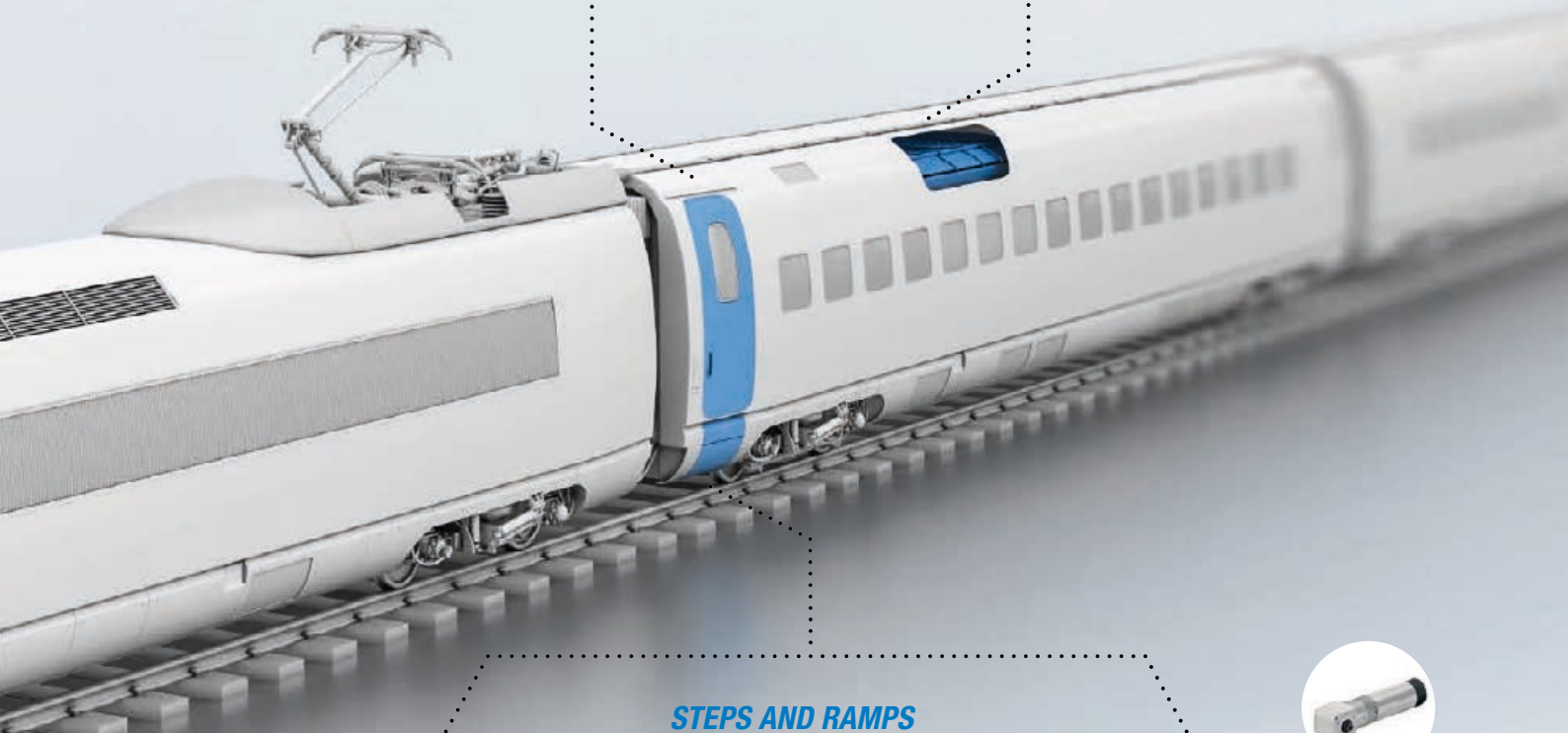

STEPS AND RAMPS

(A) Boarding aids make it easier for passengers to enter and exit the train. A three-stage spur gear extends the steps and keeps them in the correct position.

(B) Special angular gears with combined planetary and crown wheel technology are used to extend and retract folding steps and ramps.

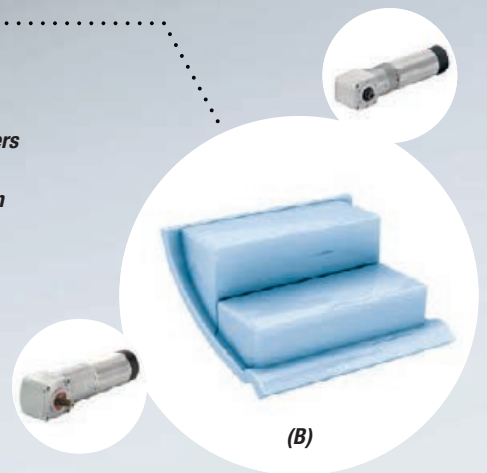
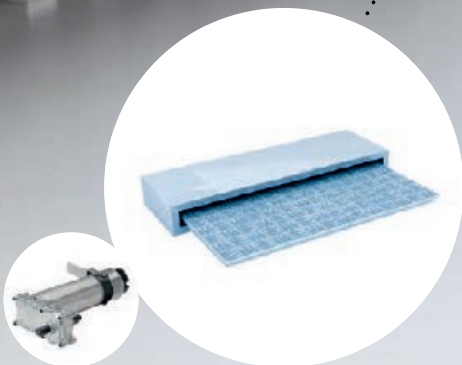

(B)



Günter Haas

**Group Leader
Electronics Development,
ebm-papst Muldingen**

Comparison: active vs. passive

The table shows a comparison between a device with active PFC and one with passive PFC. Both devices were measured at the same operating point (identical air performance). The THD value (total harmonic distortion) indicates the ratio of the effective value of the sum of all current harmonics to that of the fundamental oscillation. The THC value (total harmonic current) indicates the overall effective value of the current harmonics. From the perspective of the standard, only harmonics with the ordinal numbers 2 to 40 are relevant.

Measured value	Measurement with passive PFC	Measurement with active PFC
Effect. power P_1	245 W	242 W
Apparent power S_1	378 VA	250 VA
Reactive power Q_1	286 Var	49 Var
Max. input current I_{max}	4.88 A	1.76 A
Effect. input current I_{eff}	1.67 A	1.08 A
Power factor PF	0.65	0.98
THD (I)	116 %	2.65 %
THC (I)	1.29 A	0.03 A

Fighting the waves

The benefits of active Power Factor Correction (PFC).

Since the introduction of the standard 61000-3-2 for reducing current harmonics, active Power Factor Correction (PFC) has become ever more widespread as an active filtering measure for devices operated on single-phase grids. Active PFC tracks the input current of the sinusoidal input voltage, so that the current harmonics in the input current are significantly reduced. This generally requires a transistor, a diode, an inductance and a controller. The power factor value (PF) indicates how far the current waveform of the input current resembles the ideal sinus form and how large the phase angle is between current and voltage. An ideal case would be: $PF = 1$ (ideal sinus form for the current and phase angle between input voltage and input current $\varphi = 0^\circ$). Modern technology allows values of $PF = 0.99$ to be achieved. These kinds of high values are not necessarily required to comply with the limit values of the standard.

A passive solution can also be used in individual devices as an alternative to active PFC. This consists of an inductance arranged either in the supply line to the device or in front of the intermediate circuit capacitor.

Minimising harmonics also significantly reduces both the reactive power and the effective current. If such devices are installed, this means that smaller cable cross-sections can be used for the supply line.

If only a single fan is used as an individual device, the aforementioned standard can also be complied with using a passive PFC solution. As soon as multiple fans are used in parallel operation, use of active PFC becomes almost unavoidable.

The image shows the harmonics in a parallel operation of two sets of three fans, one with passive and one with active PFC. According to the standard, the set of fans with passive PFC in this example is not permitted. ○

CURRENT HARMONICS

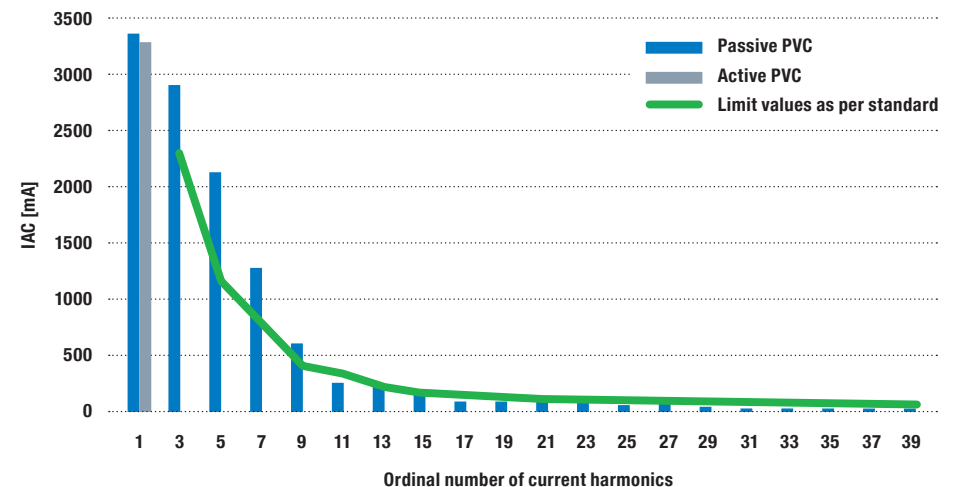

Imprint

Publisher:

ebm-papst Mulfingen
GmbH & Co. KG

Bachmühle 2

D-74673 Mulfingen

+ 49 7938 / 81 – 0

Info1@de.ebmpapst.com

www.ebmpapst.com

Responsible for content:

Thomas Borst

Editor-in-chief:

Kai Halter

Project co-ordinator:

Katrin Lindner

Editorial staff:

pr+co GmbH

www.prcoco.de

Layout

and production:

pr+co GmbH

Art Direction:

Gernot Walter

Authors:

Steffen Beck

Thomas Borst

Florian Burkhardt

Günter Haas

Norbert Hiller

Sebastian Stamm

Julian Stutz

Anton Tsuji

Katharina Walz

Reproduction and Print:

Raff GmbH

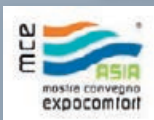

Find us here: Trade fairs & dates

Trade fairs

HARFKO, Seoul, 10 – 13 March 2015

ISH, Frankfurt, 10 – 14 March 2015

China Refrigeration, Shanghai, 8 – 10 April 2015

Hannover Messe Industrie, Hannover, 13 – 17 April 2015

Data Center EXPO, Tokyo, 13 – 15 May 2015

Frigair, Johannesburg, 3 – 5 June 2015

Mostra Convegno Expocomfort,

Singapore, 2 – 9 September 2015

IAA Pkw, Frankfurt, 15 – 27 September 2015

FEBRAVA, São Paulo, 22 – 25 September 2015

Elkom, Helsinki, 6 – 8 October 2015

Maschinenbaugipfel, Berlin, 13 – 14 October 2015

Busworld, Kortrijk, 16 – 21 October 2015

For more trade fairs dates visit: www.ebmpapst.com

Events

ebm-papst Marathon, 12 – 13 September 2015

01°2015
mag

In our online version mag.ebmpapst.com, you can find:

- all mag° articles
- more specialist articles
- latest news
- ebm-papst Twitter feed
- extra pictures and videos
- comment function





Lizzie Brown, CEO of Engineers Without Borders Australia, and Simon Bradwell, Managing Director of ebm-papst A&NZ, have been co-operating for some years. EWB supports aid projects like the one in Battambang in Cambodia (center).

Engineers for the world

ebm-papst Australia supports the regional aid agency Engineers Without Borders Australia in Melbourne.

Engineers Without Borders are active in seven countries, passing on their technical knowledge, helping development work and creating new infrastructure in remote countries and communities. ebm-papst Australia has been supporting this organisation since 2009. The non-profit organisation is comprised of engineers, scientists and students who use their skills and knowledge to provide aid in Australia and central and south-east Asia. This includes securing water supply, installing sanitary systems and renewable energy projects. “What started as a small group of people has developed over the past 11 years to a movement of 15,000 people and companies, all working together to create change through humanitarian engineering”, describes Lizzie Brown, CEO of Engineers Without Borders Australia.

For Simon Bradwell, Managing Director of ebm-papst A & NZ, supporting a project like this is a matter close to his heart. He too had contributed to social projects before starting his career at the fan manufacturer. “My wife and I went to Zambia for two years in 1999 to do voluntary work and chal-

lenge ourselves professionally”, says Bradwell. The work in various projects and the cultural and interpersonal experiences that the couple collected in Africa made a lasting impression. This is why inspiring his colleagues to help in various activities for Engineers Without Borders is a matter of course for Simon Bradwell. “For us as a business, social responsibility is very important”, he declares. “That’s why I’m pleased that we are able to help a regional aid organisation like Engineers Without Borders Australia”.

The Australian ebm-papst team regularly participates in the “Ride Around the Bay” in Melbourne and cycles with family members, friends and colleagues to raise funds for Engineers Without Borders. ebm-papst also donates ten dollars to the non-profit organisation for every completed customer experience feedback questionnaire. “The financial support from ebm-papst allows us to train many of our members and gain new ones”, explains Lizzie Brown. “ebm-papst also sponsors a range of events which are very important for the exchange of knowledge and interests”. ○



LINKED: In February, ebm-papst Australia supported the Link Festival, organised by Engineers Without Borders. The event in Melbourne brought together scientists, engineers, architects and students to discuss the latest developments in technology and

design along with social change. Specialist experts taught new approaches and shared their experiences in a range of workshops and sessions. The event offered a platform for networking, inspiration and exchanging ideas for future developments.

“ The Netherlands and Belgium are relatively small economies within the EU, which are characterised heavily by service, innovative technology and an innovation-friendly climate for foreign businesses. These are some of the factors behind the construction of Google’s new European data centre in the Netherlands, which is the size of 400 football fields. In these markets, we are meeting the requirements for energy efficiency, renewable energy and innovative solutions thanks to our GreenTech philosophy. This is borne out in the fact that 80 percent of our revenue comes from EC technology. This technology has been used for 25 years in areas like condensing gas boilers, in which the Dutch were pioneers, and efficient ventilation systems that are subject to strict standards. Of course, we also place strong emphasis on efficiency and sustainability in our own new building, from the cellar to the roof. ”



*Ad van Nistelrooij,
Managing Director,
ebm-papst Benelux B.V.
Phone: +31 492 502-900*





Discover ebm-papst.

Susanne Lohmann, project engineer at ebm-papst

At ebm-papst, we develop fans for cooling hardware. They are particularly powerful, yet remain extremely quiet, save energy and are entirely maintenance-free. Enabling even the IT manager to keep a cool head.
You can't see it. But you can feel it!

Find out more at www.ebmpapst.com/itcooling

ebmpapst

The engineer's choice