

# TECHNOFLEX®

## The Power to Perform

### **SPIDEX - die elastische Kupplung** **SPIDEX - the elastic coupling**



- Drehelastisch
- Schwingungsdämpfend
- Axial steckbar
- Durchschlagsicher
- Wartungsfrei
- Nabenwerkstoffe:  
Aluminium (Al), Aluminium Druckguss (ALU),  
Grauguss (GG), Sphäroguss (GGG), Sinterstahl (Si),  
Stahl (St)

- *Torsional elasticity*
- *Damping*
- *Blind assembly*
- *Safe against breakdown*
- *No maintenance*
- *Hub material:*  
*aluminium (Al), die-cast aluminium (ALU),*  
*cast iron (GG), SG iron (GGG), sintered steel (Si),*  
*steel (St)*

**TECHNOFLEX**  
POWER TO PERFORM



## SPIDEX® – die elastische Kupplung SPIDEX® – the elastic coupling



### Funktionsweise Technical description

Elastische Kupplungen sind in der Lage, kurzzeitige Drehmomentstöße durch zeitweilige elastische Speicherung eines Teiles der Stoßenergie zu mildern. Der Ungleichförmigkeitsgrad der Bewegungs- und Drehmomentübertragung wird somit kleiner. Elastische Kupplungen dämpfen den Körperschall und tragen somit zur Geräuschminderung bei. Die elastische SPIDEX®-Kupplung überträgt das Drehmoment formschlüssig und durchschlagsicher. Der ballig profilierte Evolventenzahn (Abb. 1) gestattet den Ausgleich von Radial- und Winkerverlagerungen der zu verbindenden Wellen. Er besteht aus einem thermoplastischen Polyurethan-Elastomer, ist ausschließlich auf Druck belastet und zeichnet sich darüber hinaus durch hohe Verschleißfestigkeit und Elastizität, gute Dämpfungseigenschaften und gute Beständigkeit gegen Öle, Fette, viele Lösemittel, Witterungseinflüsse und Ozon aus. Hinzu kommt eine gute Hydrolyse- und Tropenbeständigkeit.

Die Einsatztemperaturen liegen zwischen  $-40\text{ °C}$  und  $+100\text{ °C}$  in der Standardausführung. Kurzzeitige Temperaturspitzen bis  $+120\text{ °C}$  sind zulässig. Für Einsatztemperaturen im Bereich deutlich über  $+100\text{ °C}$  bis  $+150\text{ °C}$  ist die Zahnkranz-Serie TPS entwickelt worden (Seite 12).

Die Standardhärte des Zahnkranzes beträgt  $92^\circ$  Shore A. Für höhere Drehmomente können auch Zahnkränze mit  $95^\circ$  und  $98^\circ$  Shore A und für hohe Drehmomente ein Zahnkranz mit  $64^\circ$  Shore D eingesetzt werden, dieser ist sehr hart und hat eine geringe Dämpfung. Durch die aus Abb. 1 und Abb. 2 zu ersehende Balligkeit nehmen die Zähne des Zahnkranzes mit zunehmender Verformung eine überproportional wachsende Verformungsenergie auf (Seite 5). Der Wert der Federsteife  $CT$  des Zahnkranzes nimmt mit Vergrößerung des relativen Drehwinkels  $\varphi$  zu. Folglich arbeitet die Kupplung bei geringer Drehmomentübertragung relativ weich und mit zunehmendem Drehmoment immer härter. Hieraus ergibt sich eine progressive Federkennlinie gemäß Abb. 3. Die dynamische Federkennlinie hat einen geringfügig steileren Verlauf.

Die in Abb. 3 dargestellte Dämpfungsarbeit bewirkt die in Abb. 4 ersichtliche Dämpfung von Drehmomentstößen.

Ein besonderer Vorteil der progressiven Federkennlinie liegt im Resonanzverhalten der SPIDEX®-Kupplung. Da die kritische Resonanzdrehzahl abhängig von der Federsteife  $CT$  ist, letztere sich jedoch mit Verschiebung des Arbeitspunktes ändert, ergibt sich eine Verstimmung des Systems gemäß Abb. 5, welche die Gefahr des Aufschaukelns verringert.

Die progressive Kennlinie schützt somit vor allem die Kupplung gegen unzulässige Überbeanspruchung. Darüber hinaus kann die Federsteife  $CT$  durch eine entsprechende Wahl der Shorehärte beeinflusst werden. Eine größere Shorehärte verlagert die Resonanzdrehzahl in einen höheren, eine niedrigere Shorehärte in einen niedrigeren Bereich. Im Zweifelsfalle empfehlen wir eine Berechnung des Systems mittels der antriebs- und lastseitigen Massenträgheitsmomente.

*Elastic couplings reduce intermittent short-period torsional shocks by briefly storing part of this shock energy elastically. Any degree of uneven movement and torque transference is consequently reduced. Elastic couplings suppress body resonance and therefore contribute to noise reduction. The elastic SPIDEX® coupling transmits the torque without the risk of breakdown and backlash-free. The convex generated profiled tooth crown, see Fig. 1, allows compensation of radial and angular displacements of the two connected shafts. It consists of a thermoplastic polyurethane elastomer that is loaded exclusively under pressure, designed for high abrasion resistance and elasticity, has good damping characteristics, is resistant to oils, greases, many solvents, atmospheric effects and ozone, as well as having a good resistance to hydrolysis in tropical conditions.*

*The operating temperature range is between  $-40\text{ °C}$  and  $+100\text{ °C}$ . Short temperature peaks up to  $+120\text{ °C}$  are admissible. The TPS spider series (see p. 12) was developed for operating temperatures that are constantly well above  $+100\text{ °C}$  to  $+150\text{ °C}$ .*

*The standard hardness of the spider is  $92^\circ$  Shore A. For higher torques, a spider of  $95^\circ$  to  $98^\circ$  Shore A can be used, and for high torques a spider with  $64^\circ$  Shore D, which is extremely hard and has a low damping effect. As Figures 1 and 2 show, the convex rim of the tooth absorbs a higher proportion of deformation energy as deformation increases (see p. 5). The torsional rigidity value  $CT$  of the tooth crown increases with the torsional angle  $\varphi$ . Consequently, the coupling is relatively soft under small load conditions and becomes progressively harder as the torque increases. This causes a progressive torsion curve, as shown in Fig. 3. The dynamic torsion curve has an insignificantly steeper course.*

*The damping energy shown in Fig. 3 results in the damping of torque shocks as shown in Fig. 4.*

*The special advantage of the progressive torsion characteristic is the resonance suppression achieved by the SPIDEX® coupling, as the critical resonance speed depends on the torsional rigidity  $CT$  (see Fig. 5).*

*The progressive curve therefore mainly protects the coupling against inadmissible overstressing. Furthermore, the torsional rigidity  $CT$  of the spider can be influenced by the choice of an appropriate Shore hardness material. A larger Shore hardness moves the resonance speed higher, and a lower Shore hardness moves resonance speed into a lower range. If in doubt, we recommend a calculation of the systems dynamics by using the moments of inertia of the driving and driven sides.*

**Abb. 1**  
Unbelasteter Polyurethan-Zahn

**Fig. 1**  
Unloaded polyurethane tooth

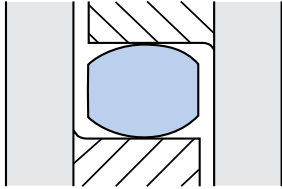

**Abb. 2**  
Belasteter Polyurethan-Zahn

**Fig. 2**  
Loaded polyurethane tooth

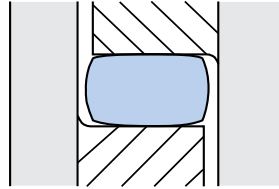

**Abb. 3**  
Progressive Drehfederkennlinie mit Hystereseschleife

**Fig. 3**  
Progressive torsion spring curve with hysteresis loop

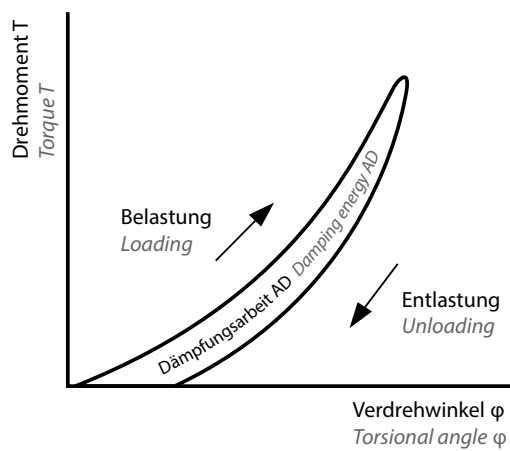

**Abb. 4**  
Vergleich Drehmomentstoß mit und ohne Dämpfung

**Fig. 4**  
Comparison of torque peak with and without damping

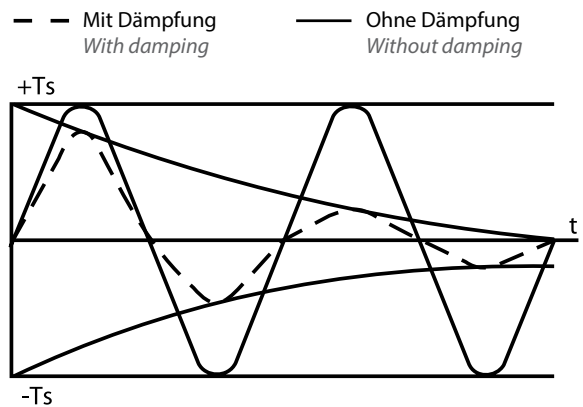

**Abb. 5**  
Resonanzverhalten elastischer Kupplungen mit linear und progressiv ansteigender Drehfederkennlinie

**Fig. 5**  
Resonance suppression of elastic couplings with linear and progressively increasing torsional characteristic

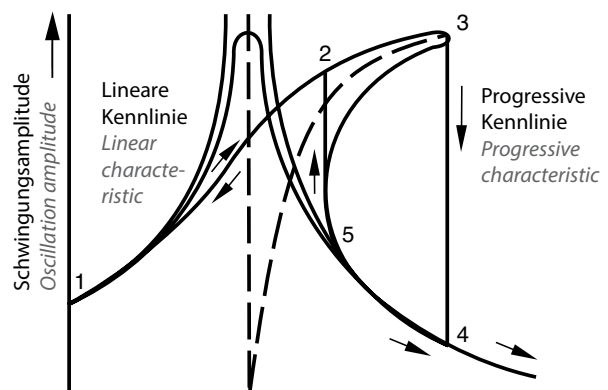

## Auswahlprozess zur Größenbestimmung Selection process for sizing determination

**Schritt 1:** Bestimmung des Nenndrehmoments Ihrer Anwendung:

$$T_N \text{ [Nm]} = \frac{P \text{ [kW]} \times 9550}{U \text{ /min [1/min]}}$$

**Schritt 2:** Berechnung des Betriebsfaktors Ihrer Anwendung mit der Tabelle auf Seite 7.  
Der Gesamtbetriebsfaktor (K) ergibt sich aus:

$$K = K1 \times K2 \times K3$$

**Schritt 3:** Berechnung des konstruktiven Drehmoments ( $T_{NK}$ ) Ihrer Anwendung:  
Konstruktives Drehmoment ( $T_{NK}$ ) =  
Nenndrehmoment ( $T_N$ ) x Betriebsfaktor (K).

**Schritt 4:** Unter Verwendung der Elastomer-Leistungsdatentabellen auf der Seite 11 den Urethan-Shore-Härtegrad auswählen, der am besten den relativen Dämpfungsanforderungen Ihrer Anwendung entspricht.

**Schritt 5:** Finden Sie als nächstes die Spalten, in denen die Werte  $T_{KN}$  und  $T_{Kmax}$  in Nm gelistet sind und vergleichen Sie diese mit dem Wert  $T_{NK}$  für Ihre Anwendung. Stellen Sie sicher, dass die Werte des Zahnkranzes größer als die Anwendungswerte sind.

$$T_{KN} \& T_{Kmax} > T_{NK}$$

**Schritt 6:** Nachdem die Größe unter Verwendung der Drehmomentwerte ausgewählt ist, stellen Sie mit Hilfe der Tabelle auf Seite 9 sicher, dass der erforderliche Bohrungsdurchmesser in die Kupplung passt.

**Schritt 7:** Überprüfen Sie sorgfältig das Gesamtmaß der Kupplung, um zu gewährleisten, dass die Kupplung in den Einbauraum passt.

**Step 1:** Determine the nominal torque of your application:

$$T_N \text{ [Nm]} = \frac{P \text{ [kW]} \times 9550}{U \text{ /min [1/min]}}$$

**Step 2:** Calculate your application service factor using the charts on page 7.  
The total service factor (K) will be:

$$K = K1 \times K2 \times K3$$

**Step 3:** Calculate the design torque ( $T_{NK}$ ) of your application:  
Design torque ( $T_{NK}$ ) = nominal torque ( $T_N$ ) x service factor (K).

**Step 4:** Using the Elastomer performance data charts on page 11, select the urethane shore hardness which best corresponds to your relative damping needs in the application.

**Step 5:** Next find the columns listing  $T_{KN}$  and  $T_{Kmax}$  values listed in Nm and compare them against the  $T_{NK}$  figure for your application. Make sure that the spider/coupling size values are larger than the application values.

$$T_{KN} \& T_{Kmax} > T_{NK}$$

**Step 6:** Once the size has been selected using the torque values, check the table on page 9 to make sure the bore size needed will fit in the coupling.

**Step 7:** Double check the overall dimensions of the coupling to ensure that it will fit in the space allowed for the coupling in the application.

Bei dem vorliegenden Auswahlprozess handelt es sich um ein vereinfachtes Verfahren zur Größenbestimmung unserer SPIDEX® Kupplung. Für eine genauere Auswahl ist die DIN 704 T2 anzuwenden. Die Welle-Nabe-Verbindung ist kundenseitig zu prüfen.

*This process is a simplified procedure for determining the correct size when selecting one of our SPIDEX® couplings. Use DIN 704 T2 when making a precise selection. The shaft-hub connection has to be checked by the customer.*

## Definition der Begriffe Definition of terms

$T_N$ [Nm]	Nenndrehmoment der Anwendung <i>Nominal torque of the application</i>
$T_{Kmax}$ [Nm]	Maximales Drehmoment der Kupplung <i>Maximum torque of the coupling</i>
P [kW]	Leistung in Kilowatt <i>Power in kilowatts</i>
U/min [1/min]	Umdrehungen pro Minute <i>Revolutions per minute</i>
Nm	Newtonmeter <i>Newton meters</i>
$T_{NK}$ [Nm]	Konstruktives Drehmoment der Anwendung <i>Constructional torque of the application</i>
$T_{KW}$ [Nm]	Wechseldrehmoment <i>Alternating torque</i>
K	Betriebsfaktor <i>Application service factor</i>

## Anwendungs-Betriebsfaktoren

### Application service factors

#### K1

	Betriebsfaktor K1 Application service factor K1
<p><b>Gleichmäßiger Betrieb</b> mit kleinen Beschleunigungsmassen. Hydraulik- und Zentrifugalpumpen, kleine Generatoren, Gebläse, Lüfter, Ventilatoren, Band/Schraubenförderer. <i>Uniform operation with small masses to be accelerated. Hydraulic and centrifugal pumps, light generators, blowers, fans, ventilators, belt/screw conveyors.</i></p>	1.0
<p><b>Gleichmäßiger Betrieb</b> mit mittleren Beschleunigungsmassen. Blechbiegemaschinen, Holzbearbeitungsmaschinen, Walzwerke, Textilmaschinen, Mischer. <i>Uniform operation with medium masses to be accelerated. Sheet metal bending machines, wood working machines, mills, textile machines, mixers.</i></p>	1.2
<p><b>Ungleichmäßiger Betrieb</b> mit mittleren Beschleunigungsmassen. Rotierende Öfen, Druckpressen, Generatoren, Schredder, Wickelmaschinen, Spinnmaschinen, Pumpen für dickflüssige Fluide. <i>Irregular operation with medium masses to be accelerated. Rotating ovens, printing presses, generators, shredders, winders, spinning machines, pumps for viscous fluids.</i></p>	1.3
<p><b>Ungleichmäßiger Betrieb</b> und Stoßbelastungen mit mittleren Beschleunigungsmassen. Betonmischer, Fallhämmer, Seilbahnen, Papiermühlen, Kompressionspumpen, Propellerpumpen, Seilwinden, Zentrifugen. <i>Irregular operation and shocks, with medium masses to be accelerated. Concrete mixers, drop hammers, cable cars, paper mills, compression pumps, propeller pumps, rope winders, centrifuges.</i></p>	1.4
<p><b>Ungleichmäßiger Betrieb</b> und starke Stoßbelastungen mit großen Beschleunigungsmassen. Bagger, Hammermühlen, Kolbenpumpen, Pressen, Erdbohrmaschinen, Scheren, Schmiedepressen, Steinbrecher. <i>Irregular operation and heavy shocks, with large masses to be accelerated. Excavators, hammer mills, piston pumps, presses, rotary boring machines, shears, forge presses, stone crushers.</i></p>	1.6
<p><b>Ungleichmäßiger Betrieb</b> und sehr starke Stoßbelastungen mit sehr großen Beschleunigungsmassen. Kolbenkompressoren und Pumpen ohne Drehzahlregelung, schwere Walzensätze, Schweißmaschinen, Ziegelpressen, Steinbrecher. <i>Irregular operation and very heavy shocks, with very large masses to be accelerated. Piston-type compressors and pumps without speed variations, heavy roller sets, welding machines, brick presses, stone crushers.</i></p>	1.8

#### K2 – für Anläufe pro Stunde

#### K2 – for starts per hour

Anläufe pro Stunde Starts per hour	100	200	400	800
Betriebsfaktor K2 Service factor K2	1.0	1.2	1.4	1.6

#### K3 – für Umgebungstemperaturen

#### K3 – for ambient temperature

Zahnkranz Typ Insert type	-50 °C	-30 °C bis/up to +30 °C	+40 °C	+50 °C	+60 °C	+70 °C	+80 °C	+90 °C	+100 °C	+110 °C	+120 °C bis/up to +150 °C
Standard	–	1.0	1.2	1.3	1.4	1.55	1.8	2.2	–	–	–
TPS	1.0	1.0	1.1	1.2	1.3	1.45	1.6	1.8	2.1	2.5	3.2

## SPIDEX®-Kupplungen für IEC-Normmotoren, Zahnkranz 92° Shore A

### SPIDEX® couplings for IEC-standard motors, spider 92° Shore A

Motorbau- größe Motor size	Welle Shaft D x l [mm]		n = 750 [1/min] Leistung P Power P		Kupp- lungs- größe Size of coupling	T <sub>K</sub> max [Nm]	n = 1000 [1/min] Leistung P Power P		Kupp- lungs- größe Size of coupling	T <sub>K</sub> max [Nm]	n = 1500 [1/min] Leistung P Power P		Kupp- lungs- größe Size of coupling	T <sub>K</sub> max [Nm]	n = 3000 [1/min] Leistung P Power P		Kupp- lungs- größe Size of coupling	T <sub>K</sub> max [Nm]														
	= 1500 [1/min]	= 3000 [1/min]	[kW]	T <sub>AN</sub> [Nm]			[kW]	T <sub>AN</sub> [Nm]			[kW]	T <sub>AN</sub> [Nm]			[kW]	T <sub>AN</sub> [Nm]																
56	9 x 20		-	-	14/16	15	0.037	0.43	14/16	15	0.06	0.4	14/16	15	0.09	0.3	14/16	15														
					15		0.045	0.52	15		0.09	0.6	15		0.12	0.4	15															
63	11 x 23		-	-	15	15	0.060	0.70	15	15	0.12	0.9	15	15	0.18	0.6	15	15														
							0.090	1.10			0.18	1.2			0.25	0.9																
71	14 x 30		0.09	1.4	15	15	0.180	2.00	15	15	0.25	1.8	15	15	0.37	1.3	15	15														
			0.12	1.8			0.250	2.80			0.37	2.5			0.55	1.9																
80	19 x 40		0.18	2.5	19/24	20	0.370	3.70	19/24	20	0.55	3.7	19/24	20	0.75	2.5	19/24	20														
			0.25	3.5			0.550	5.50			0.75	5.0			1.10	3.7																
90 S	24 x 50		0.37	5.3	19/24	20	0.750	7.90	19/24	20	1.10	7.5	19/24	20	1.50	4.9	19/24	20														
90 L			0.55	7.9			1.100	11.00			1.50	10.0			2.20	7.4																
100 L	28 x 60		0.75	11.0	24/32	70	1.500	15.00	24/32	70	2.20	15.0	24/32	70	3.00	9.8	24/32	70														
			1.10	16.0			3.00	20.0																								
112 M	28 x 60		1.50	21.0	24/32	70	2.200	22.00	24/32		4.00	27.0	24/32	70	4.00	13.0	24/32	70														
132 S	38 x 80		2.20	29.0	28/38	190	3.000	30.00	28/38	190	5.50	36.0	28/38	190	5.50	18.0	28/38	190														
132 M							3.00	40.0							4.000	39.00			7.50	49.0	7.50	25.0										
															5.500	55.00																
160 M	42 x 110		4.00	54.0	38/45	380	7.500	74.00	38/45	380	11.00	72.0	38/45	380	11.00	35.0	38/45	380														
160 L			5.50	74.0			11.000	108.00			15.00	98.0			15.00	60.0																
			180 M	-			-	-			-	18.50			121.0	42/55			530	22.00	144.0	42/55	530	22.00	72.0	42/55	530					
180 L	48 x 110		11.00	147.0	42/55	530	15.000	147.00	42/55	530	22.00	144.0	42/55	530	22.00	72.0	42/55	530														
200 L	55 x 110		15.00	196.0	42/55	530	18.500	185.00	42/55	530	30.00	195.0	42/55	530	30.00	97.0	42/55	530														
225 S							60 x 140	55 x 110							18.50	245.0			48/60	620	-	-	48/60	620	37.00	245.0	48/60	620	37.00	117.0	42/55	530
																					22.00	294.0							30.000	292.00		
250 M	65 x 140	60 x 140	30.00	390.0	65/75	1250	37.000	361.00	55/70	820	55.00	357.0	55/70	820	55.00	176.0	48/60	620														
280 S	75 x 140	65 x 140	37.00	490.0	65/75	1250	45.000	440.00	65/75	1250	75.00	487.0	65/75	1250	75.00	245.0	65/75	820														
280 M			45.00	585.0			55.000	536.00			90.00	584.0			90.00	294.0																
315 S	80 x 170	65 x 140	55.00	715.0	75/90	2560	75.000	730.00	75/90	2560	110.00	714.0	75/90	2560	110.00	350.0	65/75	1250														
315 M			75.00	970.0			90.000	876.00			132.00	857.0			132.00	420.0																
315 L			90.00	1170.0	90/100	4800	110.000	1070.00	90/100	4800	160.00	1030.0	90/100	4800	160.00	513.0	90/100	4800														
			110.00	1420.0			132.000	1280.00			200.00	1290.0			200.00	641.0																
355 L	95 x 170	75 x 140	132.00	1710.0	90/100	4800	160.000	1550.00	90/100	4800	250.00	1610.0	90/100	4800	250.00	801.0	75/90	2560														
			160.00	2070.0			200.000	1930.00			315.00	2020.0			315.00	1010.0																
			200.00	2580.0	250.000	2420.00	400.00	2280.0	400.00	1280.0																						
400 L	100 x 210	80 x 170	250.00	3230.0	110/125	9600	315.000	3040.00	100/110	6600	355.00	2280.0	100/110	6600	355.00	1140.0	90/100	4800														
											400.00	2560.0			400.00	1280.0																

Die Kupplungsvorauswahl erfolgte für den Normalbetrieb ohne Berücksichtigung von Betriebsfaktoren.  
Coupling selection made for normal operation. For other conditions please notify the safety factors.



## Abmessungen SPIDEX®-Kupplungen Dimensions SPIDEX® couplings

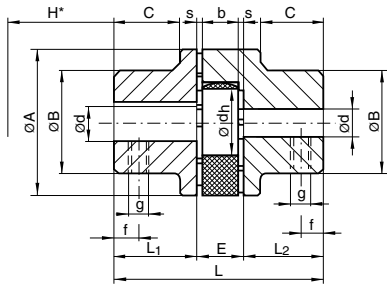

Nabenkombination A/A  
Hub combination A/A

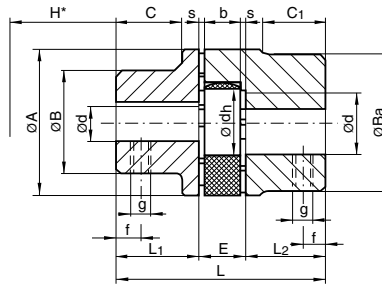

Nabenkombination A/B  
Hub combination A/B

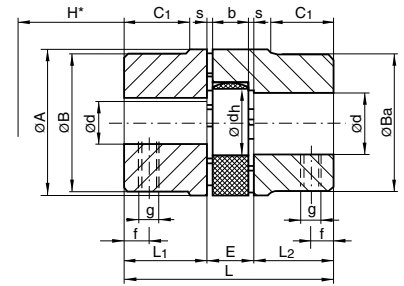

Nabenkombination B/B  
Hub combination B/B

SPIDEX®	Bohrungen Bores				Abmessungen [mm] Dimensions [mm]														Gewicht Weight [kg]	Naben Sonderlänge Special hub length [mm]
	Fertigbohrung Finish bore				A	B	Ba	L	L1/L2	E	s	b	C	C1	dh	g	f	H*		
	Nabe A Hub A		Nabe B Hub B		min	max	min	max												
Werkstoff: Aluminium Druckguss (ALU) Material: die-cast aluminium (ALU)																				
A15	-	-	4	15	26	-	26	28	10	8	1.0	6	-	-	12	M5	5	8	0.025	-
A19/24	6	19	19	24	40	32	39	66	25	16	2.0	12	20	21	18	M5	10	14	0.130	55
A24/32	8	24	16	32	55	40	53	78	30	18	2.0	14	24	26	27	M5	10	16	0.260	60
A28/38	10	28	28	38	65	48	63	90	35	20	2.5	15	28	29	30	M6	15	18	0.460	60
A38/45	14	38	38	45	80	66	79	114	45	24	3.0	18	37	39	38	M8	15	19	0.900	70
Werkstoff: Grauguss (GG), Sphäroguss (GGG), Stahl (St), Sinterstahl (Si) Material: cast iron (GG), SG iron (GGG), steel (St), sintered steel (Si)																				
A14/16 St	-	-	4	16	30	-	30	35	11	13	1.5	10	-	-	10	M4	5	12	0.140	18.5
A19/24 GG/St/Si	6	19	12	24	40	32	39	66	25	16	2.0	12	20	21	18	M5	10	14	0.350	55
A24/32 GG/St/Si	10	24	14	32	55	40	52	78	30	18	2.0	14	24	26	27	M5	10	16	1.000	60
A28/38 GG/St/Si	12	28	28	38	65	48	62	90	35	20	2.5	15	28	29	30	M6	15	18	1.600	80
A38/45 GG/GGG/St/Si	14	38	38	45	80	66	77	114	45	24	3.0	18	37	37	38	M8	15	19	2.300	110
A42/55 GG/GGG/St/Si	19	42	42	55	95	75	94	126	50	26	3.0	20	40	40	46	M8	20	21	3.600	110
A48/60 GG/GGG/St/Si	19	48	48	60	105	85	102	140	56	28	3.5	21	45	45	51	M8	20	22	4.800	110
A55/70 GG/GGG/St	19	55	55	70	120	98	118	160	65	30	4.0	22	52	52	60	M10	20	23	7.400	140
A65/75 GG/GGG/St	22	65	65	75	135	115	132	185	75	35	4.5	26	61	59	68	M10	20	27	10.900	140
A75/90 GG/GGG/St	30	75	75	90	160	135	158	210	85	40	5.0	30	69	65	80	M10	25	31	17.700	195
A90/100 GG/GGG/St	40	90	90	100	200	160	180	245	100	45	5.5	34	81	81	100	M10	25	35	29.500	140/210
A100/110 GG/GGG/St	-	-	55	110	225	-	200	270	110	50	6.0	38	-	89	113	M16	30	39	43.500	-
A110/125 GG/GGG/St	-	-	65	125	255	-	230	295	120	55	6.5	42	-	96	127	M16	35	43	63.000	-
A125/145 GG/GGG/St	-	-	65	145	290	-	265	340	140	60	7.0	46	-	112	147	M16	40	47	95.000	-

H\* ist das Mindestmaß, um welches die Aggregate auseinander geschoben werden müssen, um einen radialen Ausbau zu ermöglichen. Fertigbohrung nach ISO-Passung H7, Passfedernut nach DIN 6885, Blatt 1 (JS9). Das Gewicht und Massenträgheitsmoment beziehen sich auf die Werkstoffe Al/GG/GGG bei max. möglichem Durchmesser d ohne Nut. H\* is the minimum dimension required for the disassembly of the aggregates in the radial direction. Finish bore acc. to ISO standard H7, keyway acc. to DIN 6885, sheet 1 (JS9). Weight and moment of inertia in relation to the materials Al/GG/GGG with max. diameter without keyway.

### Standardprogramm

- A Naben und B Naben in Aluminium Druckguss „ALU“ und Grauguss „GG“
- B Naben in Sphäroguss „GGG“, Stahl „St“, Sinterstahl „Si“

- Sonderanfertigungen lieferbar
- Baureihen 140/160/180 auf Anfrage

### Standard programme

- A hubs and B hubs made of die-cast aluminium „ALU“ and cast iron „GG“
- B hubs made of SG iron „GGG“, steel „St“, sintered steel „Si“

- Custom-made versions available
- Series 140/160/180 on request

### Massenträgheitsmomente J [kg m<sup>2</sup>] (Standardnabe mit maximalem Bohrungsdurchmesser ohne Nut)

Moment of inertia J [kg m<sup>2</sup>] (Standard hub with max. diameter of bore without keyway)

Nabenteil Part of coupling	Material Material	Kupplungsgröße Coupling size														
		14/16	15	19/24	24/32	28/38	38/45	42/55	48/60	55/70	65/75	75/90	90/100	100/110	110/125	125/145
Nabe A Hub A	Al	-	-	0.000010	0.000040	0.000100	0.000350	-	-	-	-	-	-	-	-	-
	GG/GGG/St	-	-	0.000050	0.000250	0.000400	0.000100	0.002000	0.003000	0.006000	0.012500	0.025000	0.069000	-	-	-
Nabe B Hub B	Al	-	0.000004	0.000020	0.000090	0.000200	0.000450	-	-	-	-	-	-	-	-	-
	GG/GGG/St	0.000020	-	0.000050	0.000200	0.000700	0.001000	0.003000	0.005000	0.010000	0.018300	0.041000	0.090000	0.154000	0.091000	0.575000
Zahnkranz Spider	PU	-	-	0.000003	0.000010	0.000020	0.000050	0.000100	0.000200	0.000300	0.000500	0.002000	0.004000	0.007000	0.015000	0.025000

## Abmessungen SPIDEX®-Flanschkupplungen Dimensions SPIDEX® flange couplings

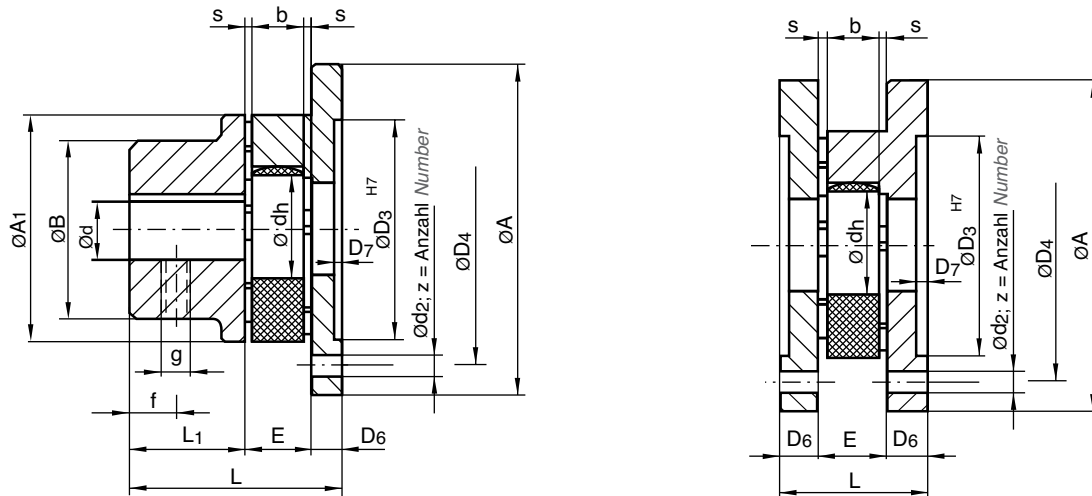

### Baureihe F Series F

SPIDEX®	Fertigbohrung <sup>1)</sup> Finish bore <sup>1)</sup>		Abmessungen [mm] Dimensions [mm]																	Gewicht Weight [kg]	Massen- trägheits- moment <sup>2)</sup> Moment of inertia <sup>2)</sup> J [kg·m <sup>2</sup> ]
	min	max <sup>4)</sup>	A	A1	B	L1	L	E	s	b	dh	g	f	D6	D7	d2 DIN 69	z Anzahl Number	D3	D4		
F 28	10	28	100	65	65	35	65	20	2.5	15	30	M8	15	10	1.5	7	6	65	80	1.18	0.0012
F 38	14	38	115	80	66	45	79	24	3.0	18	38	M8	15	10	1.5	7	6	80	95	1.87	0.0023
F 42	19	42	140	95	75	50	88	26	3.0	20	46	M8	20	12	2.0	9	6	95	115	3.06	0.0054
F 48	19	48	150	105	85	56	96	28	3.5	21	51	M8	20	12	2.0	9	8	105	125	3.88	0.0080
F 55	19	55	175	120	98	65	111	30	4.0	22	60	M10	20	16	2.0	11	8	120	145	6.21	0.0178
F 65	22	65	190	135	115	75	126	35	4.5	26	68	M10	20	16	2.0	11	10	135	160	8.63	0.0293
F 75	30	75	215	160	135	85	144	40	5.0	30	80	M10	25	19	2.5	14	10	160	185	13.20	0.0595
F 90	40	90	260	200	160	100	165	45	5.5	34	100	M12	30	20	3.0	14	12	200	225	22.00	0.1443

### Baureihe FF Series FF

SPIDEX®	Abmessungen [mm] Dimensions [mm]													Gewicht Weight [kg]	Massenträgheits- moment <sup>2)</sup> Moment of inertia <sup>2)</sup> J [kg·m <sup>2</sup> ]
	A	L	E	s	b	dh	D6	D7	d2 DIN 69 <sup>3)</sup>	z Anzahl Number	D3	D4			
FF 28	100	40	20	2.5	15	30	10	1.5	7	6	65	80	1.19	0.0015	
FF 38	115	44	24	3.0	18	38	10	1.5	7	6	80	95	1.66	0.0028	
FF 42	140	50	26	3.0	20	46	12	2.0	9	6	95	115	2.91	0.0072	
FF 48	150	52	28	3.5	21	51	12	2.0	9	8	105	125	3.35	0.0092	
FF 55	175	62	30	4.0	22	60	16	2.0	11	8	120	145	5.78	0.0230	
FF 65	190	67	35	4.5	26	68	16	2.0	11	10	135	160	7.13	0.0340	
FF 75	215	78	40	5.0	30	80	19	2.5	14	10	160	185	10.50	0.0650	
FF 90	260	85	45	5.5	34	100	20	3.0	14	12	200	225	16.50	0.1500	

- 1) Fertigbohrung nach ISO-Passung H7, Passfedernut nach DIN 6885, Blatt 1 (JS9).
- 2) Gewicht und Massenträgheitsmoment für Werkstoffe GG/GGG bei maximalem Bohrungsdurchmesser ohne Nut.
- 3) Wenn Gewindebohrungen anstatt Durchgangsbohrungen benötigt werden, ändert sich die Flanschbezeichnung in BF bzw. BFF.
- 4) Wenn größere Fertigbohrungen benötigt werden, können B-Naben verwendet werden.

- 1) Finish bore acc. to ISO standard H7, keyway acc. to DIN 6885, sheet 1 (JS9).
- 2) Weight and moment of inertia in relation to the materials GG/GGG with max. diameter without keyway.
- 3) If threaded bores are required instead of through bores, flange designation is changed to "BF" or "BFF".
- 4) If larger bore diameters are required, hub type B may be used.



## Standard-Zahnkränze Standard spiders



**Zahnkranz Polyurethan  
92° Shore A**  
*Spider polyurethane  
92° Shore A*

- Weiß  
*White*
- Allgemeine Antriebe  
*Normal drives*



**Zahnkranz Polyurethan  
95/98° Shore A**  
*Spider polyurethane  
95/98° Shore A*

- Rot  
*Red*
- Allgemeine Antriebe mit erhöhten Belastungen  
*Normal drives with high performance*



**Zahnkranz Polyurethan  
64° Shore D**  
*Spider polyurethane  
64° Shore D*

- Grün  
*Green*
- Hohe Belastbarkeit mit geringem Verdrehwinkel  
*High performance with small torsional angle*

## Technische Daten Technical data

Zahnkranz Spider	Größe Size	Drehmoment <i>Torque</i> [Nm]			Max. Drehzahl Max. RPM n [1/min]		Verdrehwinkel Torsional angle		Drehfedersteife <i>Torsional rigidity</i> C <sub>dyn</sub> [Nm/rad]				Verhältnis- mäßige Dämpfung Relative damping			
		Nenn Contin T <sub>KN</sub>	Maximal Maximum T <sub>Kmax</sub>	Wechsel Alternat. T <sub>KW</sub>	V*	30 m/s	40 m/s	T <sub>KN</sub> Φ <sub>KN</sub>	T <sub>Kmax</sub> Φ <sub>Kmax</sub>	1.00 T <sub>KN</sub>	0.75 T <sub>KN</sub>	0.5 T <sub>KN</sub>		0.25 T <sub>KN</sub>		
<b>92° Shore</b>	14/16, 15	7.5	15	2.0	19000	–	6.4°	10°	0.38 x 10 <sup>3</sup>	0.31 x 10 <sup>3</sup>	0.24 x 10 <sup>3</sup>	0.14 x 10 <sup>3</sup>	0.75			
Skala A Farbe: Weiß  Scale A Colour: White	19/24	10.0	20	2.6	14000	19000	3.2°	5°	1.28 x 10 <sup>3</sup>	1.05 x 10 <sup>3</sup>	0.80 x 10 <sup>3</sup>	0.47 x 10 <sup>3</sup>				
	24/32	35.0	70	9.1	10600	14000			4.86 x 10 <sup>3</sup>	3.98 x 10 <sup>3</sup>	3.01 x 10 <sup>3</sup>	1.79 x 10 <sup>3</sup>				
	28/38	95.0	190	25.0	8500	11800			10.90 x 10 <sup>3</sup>	8.94 x 10 <sup>3</sup>	6.76 x 10 <sup>3</sup>	4.01 x 10 <sup>3</sup>				
	38/45	190.0	380	49.0	7100	9500			21.05 x 10 <sup>3</sup>	17.26 x 10 <sup>3</sup>	13.05 x 10 <sup>3</sup>	7.74 x 10 <sup>3</sup>				
	42/55	265.0	530	69.0	6000	8000			23.74 x 10 <sup>3</sup>	19.47 x 10 <sup>3</sup>	14.72 x 10 <sup>3</sup>	8.73 x 10 <sup>3</sup>				
	48/60	310.0	620	81.0	5600	7100			36.70 x 10 <sup>3</sup>	30.09 x 10 <sup>3</sup>	22.75 x 10 <sup>3</sup>	13.49 x 10 <sup>3</sup>				
	55/70	410.0	820	107.0	4750	6300			50.72 x 10 <sup>3</sup>	41.59 x 10 <sup>3</sup>	31.45 x 10 <sup>3</sup>	18.64 x 10 <sup>3</sup>				
	65/75	625.0	1250	163.0	4250	5600			97.13 x 10 <sup>3</sup>	79.65 x 10 <sup>3</sup>	60.22 x 10 <sup>3</sup>	35.70 x 10 <sup>3</sup>				
	75/90	1280.0	2560	333.0	3550	4750			113.32 x 10 <sup>3</sup>	92.92 x 10 <sup>3</sup>	70.26 x 10 <sup>3</sup>	41.65 x 10 <sup>3</sup>				
	90/100	2400.0	4800	624.0	2800	3750			190.09 x 10 <sup>3</sup>	155.87 x 10 <sup>3</sup>	117.86 x 10 <sup>3</sup>	69.86 x 10 <sup>3</sup>				
	100/110	3300.0	6600	858.0	2500	3350			253.08 x 10 <sup>3</sup>	207.53 x 10 <sup>3</sup>	156.91 x 10 <sup>3</sup>	93.01 x 10 <sup>3</sup>				
	110/125	4800.0	9600	1248.0	2240	3000			311.61 x 10 <sup>3</sup>	255.52 x 10 <sup>3</sup>	193.20 x 10 <sup>3</sup>	114.52 x 10 <sup>3</sup>				
125/145	6650.0	13300	1729.0	2000	2650	474.86 x 10 <sup>3</sup>	389.39 x 10 <sup>3</sup>	294.41 x 10 <sup>3</sup>	174.51 x 10 <sup>3</sup>							
<b>98° Shore</b>	14/16, 15	12.5	25	3.3	19000	–	3.2°	5°	0.56 x 10 <sup>3</sup>	0.46 x 10 <sup>3</sup>	0.35 x 10 <sup>3</sup>	0.21 x 10 <sup>3</sup>	0.70			
Skala A Farbe: Rot  Scale A Colour: Red	19/24	17.0	34	4.4	14000	19000	3.2°	5°	2.92 x 10 <sup>3</sup>	2.39 x 10 <sup>3</sup>	1.81 x 10 <sup>3</sup>	1.07 x 10 <sup>3</sup>				
	24/32	60.0	120	16.0	10600	14000			9.93 x 10 <sup>3</sup>	8.14 x 10 <sup>3</sup>	6.16 x 10 <sup>3</sup>	3.65 x 10 <sup>3</sup>				
	28/38	160.0	320	42.0	8500	11800			26.77 x 10 <sup>3</sup>	21.95 x 10 <sup>3</sup>	16.60 x 10 <sup>3</sup>	9.84 x 10 <sup>3</sup>				
	38/45	325.0	650	85.0	7100	9500			48.57 x 10 <sup>3</sup>	39.83 x 10 <sup>3</sup>	30.11 x 10 <sup>3</sup>	17.85 x 10 <sup>3</sup>				
	42/55	450.0	900	117.0	6000	8000			54.50 x 10 <sup>3</sup>	44.69 x 10 <sup>3</sup>	33.79 x 10 <sup>3</sup>	20.03 x 10 <sup>3</sup>				
	48/60	525.0	1050	137.0	5600	7100			65.29 x 10 <sup>3</sup>	53.54 x 10 <sup>3</sup>	40.48 x 10 <sup>3</sup>	24.00 x 10 <sup>3</sup>				
	55/70	685.0	1370	178.0	4750	6300			94.97 x 10 <sup>3</sup>	77.88 x 10 <sup>3</sup>	58.88 x 10 <sup>3</sup>	34.90 x 10 <sup>3</sup>				
	<b>95° Shore</b>	65/75	940.0	1880	244.0	4250			5600	3.2°	5°	129.51 x 10 <sup>3</sup>		106.20 x 10 <sup>3</sup>	80.30 x 10 <sup>3</sup>	47.60 x 10 <sup>3</sup>
	Skala A Farbe: Rot  Scale A Colour: Red	75/90	1920.0	3840	499.0	3550			4750			197.50 x 10 <sup>3</sup>		161.95 x 10 <sup>3</sup>	122.45 x 10 <sup>3</sup>	72.58 x 10 <sup>3</sup>
		90/100	3600.0	7200	936.0	2800			3750			312.20 x 10 <sup>3</sup>		256.00 x 10 <sup>3</sup>	193.56 x 10 <sup>3</sup>	114.73 x 10 <sup>3</sup>
		100/110	4950.0	9900	1287.0	2500			3350			383.26 x 10 <sup>3</sup>		314.27 x 10 <sup>3</sup>	237.62 x 10 <sup>3</sup>	140.85 x 10 <sup>3</sup>
		100/125	7200.0	14400	1872.0	2240			3000			690.06 x 10 <sup>3</sup>	565.85 x 10 <sup>3</sup>	427.84 x 10 <sup>3</sup>	253.60 x 10 <sup>3</sup>	
125/145		10000.0	20000	2600.0	2000	2650	1343.64 x 10 <sup>3</sup>	1101.79 x 10 <sup>3</sup>	833.06 x 10 <sup>3</sup>			493.79 x 10 <sup>3</sup>				
<b>64° Shore**</b>		24/32	75.0	150	19.5	10600	14000	2.5°	3.6°			15.11 x 10 <sup>3</sup>	12.39 x 10 <sup>3</sup>	9.37 x 10 <sup>3</sup>	5.55 x 10 <sup>3</sup>	
Skala D Farbe: Grün  Scale D Colour: Green	28/38	200.0	400	52.0	8500	11800	27.52 x 10 <sup>3</sup>			22.57 x 10 <sup>3</sup>	17.06 x 10 <sup>3</sup>	10.12 x 10 <sup>3</sup>				
	38/45	405.0	810	105.0	7100	9500	70.15 x 10 <sup>3</sup>			57.52 x 10 <sup>3</sup>	43.49 x 10 <sup>3</sup>	25.78 x 10 <sup>3</sup>				
	42/55	560.0	1120	146.0	6000	8000	79.86 x 10 <sup>3</sup>			65.49 x 10 <sup>3</sup>	49.52 x 10 <sup>3</sup>	29.35 x 10 <sup>3</sup>				
	48/60	655.0	1310	170.0	5600	7100	95.51 x 10 <sup>3</sup>			78.32 x 10 <sup>3</sup>	59.22 x 10 <sup>3</sup>	35.10 x 10 <sup>3</sup>				
	55/70	825.0	1650	215.0	4750	6300	107.52 x 10 <sup>3</sup>			88.50 x 10 <sup>3</sup>	66.91 x 10 <sup>3</sup>	39.66 x 10 <sup>3</sup>				
	65/75	1175.0	2350	306.0	4250	5600	151.09 x 10 <sup>3</sup>			123.90 x 10 <sup>3</sup>	93.68 x 10 <sup>3</sup>	55.53 x 10 <sup>3</sup>				
	75/90	2400.0	4800	624.0	3550	4750	248.22 x 10 <sup>3</sup>			203.54 x 10 <sup>3</sup>	153.90 x 10 <sup>3</sup>	91.22 x 10 <sup>3</sup>				
	90/100	4500.0	9000	1170.0	2800	3750	674.52 x 10 <sup>3</sup>			553.11 x 10 <sup>3</sup>	418.20 x 10 <sup>3</sup>	247.89 x 10 <sup>3</sup>				

\* Bei Umfangsgeschwindigkeit über V = 30 m/s ist dynamisches Wuchten erforderlich. \*\* In Verbindung mit GG-Naben bitte Rücksprache  
\* For speeds of over V = 30 m/s dynamic balancing is necessary. \*\* Please contact us if spider is to be used in combination with cast-iron (GG) hubs

## TPS-Zahnkränze für den Einsatz bei hohen Temperaturen TPS spiders for high-temperature usage



**TPS-Zahnkranz**  
Polyurethan optimiert  
**92° Shore A**  
TPS Spider  
high-performance  
polyurethane  
92° Shore A

■ Gelb  
Yellow

**TPS-Zahnkranz**  
Polyurethan optimiert  
**98° Shore A**  
TPS Spider  
high-performance  
polyurethane  
98° Shore A

■ Weinrot  
Wine Red

- Jetzt bis +150 °C Einsatztemperatur
- Hergestellt aus Hochleistungs-PU-Kunststoff
- Für SPIDEX®-Kupplungsgrößen von 19 – 90
- Now for operating temperatures up to +150 °C
- Made from high-performance polyurethane
- For SPIDEX® couplings sizes 19 – 90

## Technische Daten Technical data

Zahnkranz Spider	Größe Size	Drehmoment Torque [Nm]			Max. Drehzahl Max. rotation n [1/min]		Verdrehwinkel Torsional angle		Drehfedersteife Torsional rigidity C <sub>dyn</sub> [Nm/rad]				Verhältnis- mäßige Dämpfung Relative damping
		Nenn Contin. T <sub>KN</sub>	Maximal Max. T <sub>Kmax</sub>	Wechsel Alternat. T <sub>KW</sub>	V*	30 m/s	40 m/s	T <sub>KN</sub> Φ <sub>KN</sub>	T <sub>Kmax</sub> Φ <sub>Kmax</sub>	1.00 T <sub>KN</sub>	0.75 T <sub>KN</sub>	0.5 T <sub>KN</sub>	
92° Shore Skala A Farbe: Gelb Scale A Colour: Yellow	19/24	10	20	2.6	14000	19000	3.2°	5°	1.28 x 10 <sup>3</sup>	1.05 x 10 <sup>3</sup>	0.80 x 10 <sup>3</sup>	0.47 x 10 <sup>3</sup>	0.75
	24/32	35	70	9.1	10600	14000			4.86 x 10 <sup>3</sup>	3.98 x 10 <sup>3</sup>	3.01 x 10 <sup>3</sup>	1.79 x 10 <sup>3</sup>	
	28/38	95	190	25.0	8500	11800			10.90 x 10 <sup>3</sup>	8.94 x 10 <sup>3</sup>	6.76 x 10 <sup>3</sup>	4.01 x 10 <sup>3</sup>	
	38/45	190	380	49.0	7100	9500			21.05 x 10 <sup>3</sup>	17.26 x 10 <sup>3</sup>	13.05 x 10 <sup>3</sup>	7.74 x 10 <sup>3</sup>	
	42/55	265	530	69.0	6000	8000			23.74 x 10 <sup>3</sup>	19.47 x 10 <sup>3</sup>	14.72 x 10 <sup>3</sup>	8.73 x 10 <sup>3</sup>	
	48/60	310	620	81.0	5600	7100			36.70 x 10 <sup>3</sup>	30.09 x 10 <sup>3</sup>	22.75 x 10 <sup>3</sup>	13.49 x 10 <sup>3</sup>	
	55/70	410	820	107.0	4750	6300			50.72 x 10 <sup>3</sup>	41.59 x 10 <sup>3</sup>	31.45 x 10 <sup>3</sup>	18.64 x 10 <sup>3</sup>	
	65/75	625	1250	163.0	4250	5600			97.13 x 10 <sup>3</sup>	79.65 x 10 <sup>3</sup>	60.22 x 10 <sup>3</sup>	35.70 x 10 <sup>3</sup>	
	75/90	1280	2560	333.0	3550	4750			113.32 x 10 <sup>3</sup>	92.92 x 10 <sup>3</sup>	70.26 x 10 <sup>3</sup>	41.65 x 10 <sup>3</sup>	
90/100	2400	4800	624.0	2800	3750	190.09 x 10 <sup>3</sup>	155.87 x 10 <sup>3</sup>	117.86 x 10 <sup>3</sup>	69.86 x 10 <sup>3</sup>				
98° Shore Skala A Farbe: Weinrot Scale A Colour: Wine Red	19/24	17	34	4.4	14000	19000	6.4°	10°	2.92 x 10 <sup>3</sup>	2.39 x 10 <sup>3</sup>	1.81 x 10 <sup>3</sup>	1.07 x 10 <sup>3</sup>	0.70
	24/32	60	120	16.0	10600	14000	3.2°	5°	9.93 x 10 <sup>3</sup>	8.14 x 10 <sup>3</sup>	6.16 x 10 <sup>3</sup>	3.65 x 10 <sup>3</sup>	
	28/38	160	320	42.0	8500	11800			26.77 x 10 <sup>3</sup>	21.95 x 10 <sup>3</sup>	16.60 x 10 <sup>3</sup>	9.84 x 10 <sup>3</sup>	
	38/45	325	650	85.0	7100	9500			48.57 x 10 <sup>3</sup>	39.83 x 10 <sup>3</sup>	30.11 x 10 <sup>3</sup>	17.85 x 10 <sup>3</sup>	
	42/55	450	900	117.0	6000	8000			54.50 x 10 <sup>3</sup>	44.69 x 10 <sup>3</sup>	33.79 x 10 <sup>3</sup>	20.03 x 10 <sup>3</sup>	
	48/60	525	1050	137.0	5600	7100			65.29 x 10 <sup>3</sup>	53.54 x 10 <sup>3</sup>	40.48 x 10 <sup>3</sup>	24.00 x 10 <sup>3</sup>	
55/70	685	1370	178.0	4750	6300	94.97 x 10 <sup>3</sup>			77.88 x 10 <sup>3</sup>	58.88 x 10 <sup>3</sup>	34.90 x 10 <sup>3</sup>		
95° Shore Skala A, Farbe: Rot Scale A, Colour: Red	65/75	940	1880	244.0	4250	5600	3.2°	5°	129.51 x 10 <sup>3</sup>	106.20 x 10 <sup>3</sup>	80.30 x 10 <sup>3</sup>	47.60 x 10 <sup>3</sup>	
	75/90	1920	3840	499.0	3550	4750			197.50 x 10 <sup>3</sup>	161.95 x 10 <sup>3</sup>	122.45 x 10 <sup>3</sup>	72.58 x 10 <sup>3</sup>	
	90/100	3600	7200	936.0	2800	3750			312.20 x 10 <sup>3</sup>	256.00 x 10 <sup>3</sup>	193.56 x 10 <sup>3</sup>	114.73 x 10 <sup>3</sup>	

\* Bei Umfangsgeschwindigkeit über V = 30 m/s ist dynamisches Wuchten erforderlich.  
\* For speeds of over V = 30 m/s dynamic balancing is necessary.

\* Für Umfangsgeschwindigkeit über V = 35 m/s nur Stahl bzw. Sphäroguss verwenden.  
\* For rotational speeds above V = 35 m/s, use only steel or SG iron.

## Einsatzbedingungen für SPIDEX®-Zahnkränze (Standard und TPS) Operating conditions for SPIDEX® spiders (Standard and TPS)

	Standard	TPS	Standard	TPS	Standard
Zahnkranzhärte Hardness of spider	92° Shore A	92° Shore A	95°/98° Shore A	98° Shore A	64° Shore D
Zahnkranzfarbe Colour of spider	Weiß White	Gelb Yellow	Rot Red	Weinrot Wine Red	Grün Green
Zul. Temperaturbereich Dauereinsatz Permissible durable temperature range	-40 °C bis/up to +90 °C	-50 °C bis/up to +120 °C	-30 °C bis/up to +100 °C	-50 °C bis/up to +120 °C	-20 °C bis/up to +100 °C
Zul. kurzfristige Temperaturspitzen Permissible short-term temperature peaks	-50 °C bis/up to +120 °C	-50 °C bis/up to +150 °C	-40 °C bis/up to +120 °C	-50 °C bis/up to +150 °C	-30 °C bis/up to +120 °C
Dämpfung Damping	Gut Good	Gut Good	Mittel Medium	Mittel Medium	Gering Low
Elastizität Elasticity	Mittel Medium	Mittel Medium	Hart Hard	Hart Hard	Sehr hart Very hard
Abriebfestigkeit Abrasion resistance	Sehr gut Very good	Sehr gut Very good	Gut Good	Gut Good	Gut Good
Dauerfestigkeit Durability	Sehr gut Very good	Sehr gut Very good	Sehr gut Very good	Sehr gut Very good	Sehr gut Very good
Einsatzbereiche Typical applications	Allgemeine Antriebe Normal drives	Allgemeine Antriebe Normal drives	Allgemeine Antriebe mit erhöhten Belastungen Normal drives with high performance	Allgemeine Antriebe mit erhöhten Belastungen Normal drives with high performance	Hohe Belastbarkeit mit geringem Verdrehwinkel High performance with small torsional angle

**Bestellbezeichnungen für SPIDEX®**  
*Order description for SPIDEX®*

**Typenbezeichnung Kupplungsnahe**  
*Model type of hub*

KL		ST	A38/45 .		A35 x 31	L = 70		SO	
Standard <i>Standard</i>	-					<b>Verlängerte Naben</b> <i>Extended hub length</i>			
Klemmnabe <i>Clamping hub</i>	KL					-	Standard <i>Standard</i>		
						70	Siehe Seite 9 <i>See page 9</i>		
Nabenwerkstoff <i>Material of hub</i>			Nabengröße/Nabenausführung <i>Size/Design of hub</i>		Beispiel Fertigbohrung <i>Example finish bore</i>		Sonderbearbeitung <i>Special machining</i>		
Aluminium <i>Aluminium</i>	Al	Nabenausführung A <i>Hub A</i>	A15	A14/16	Ung.	Ungebohrt <i>Unbored</i>		-	Standard <i>Standard</i>
Aluminium Druckguss <i>Die-cast aluminium</i>	ALU		A19	A19/24	Vorg.	Vorgebohrt <i>Prebored</i>		SO	Sonderzeichnung <i>Special drawing</i>
Sinterstahl <i>Sintered steel</i>	Si		A24	A24/32	38H7	Metrisch* <i>Metric*</i>			
Grauguss <i>Cast iron</i>	GG		A28	A28/38	B17	Kegelig** <i>Tapered**</i>			
Sphäroguss <i>SG iron</i>	GGG		A38	A38/45	F	Zöllig*** <i>Inch bored***</i>			
Stahl <i>Steel</i>	St		A42	A42/55	Profile	SAE	SAE 16/32Z13***		
			A48	A48/60		DIN 5482	A35x31***		
			A55	A55/70	DIN 5480	N30x2x14x9G***			
			A65	A65/75					
			A75	A75/90					
			A90	A90/100					
			A100	A100/110					
		A110	A110/125						
		A125	A125/145						

\* Siehe Seite 14 *See page 14*  
 \*\* Siehe Seite 16 *See page 16*  
 \*\*\* Siehe Seite 15 *See page 15*

**Typenbezeichnung Kupplungsflansch**  
*Model type of flange*

GGG		A38 . FLANSCH	F		
		<b>FLANGE</b>			
<b>Flanschwerkstoff</b> <i>Material of flange</i>		Flanschtyp <i>Type of flange</i>	<b>Flanschausführung</b> <i>Desig of flange</i>		
Sphäroguss <i>SG iron</i>	GGG		A28	-	Ungebohrt <i>Unbored</i>
GGG40			A38	F	Durchgangslöcher <i>Through bores</i>
			A42	BF	Gewindebohrungen <i>Threaded bores</i>
			A48	CFA	Ausführung für Hydraulikpumpen Fabrikat LINDE
			A55	CFB	Designed for hydraulic pumps manufacturer LINDE
			A65	CFD	
			A75		
		A90			
	A100				

## Basisprogramm metrische Bohrungen

### Standard metric bores

Typ Type	Nabe Hub	Material Material	Fertigbohrung ISO-Passung H7, Nut nach DIN 6885, Blatt 1 Finish bore acc. to ISO standard H7, keyway acc. to DIN 6885, sheet 1																											
			6	7	8	9	10	11	12	14	15	16	17	18	19	20	22	24	25	28	30	32	35	38	40	42	45	48	50	55
A14/16	B	St			x	x	x	x	x	x																				
A14/16	L = 18.5																													
A15	B	Al	x	x	x	x	x	x	x	x	x																			
A19	A	Al	x	x	x	x	x	x	x	x	x	x																		
A19/24	B																													
A19/24	L = 55.0																													
A19	A	GG																												
A19/24	B																													
A24	A	Al																												
A24/32	B																													
A24/32	L = 60.0																													
A24	A	GG																												
A24/32	B																													
A24/32	L = 60.0																													
A28	A	Al																												
A28/38	B																													
A28/38	L = 60.0																													
A28	A	GG																												
A28/38	B																													
A28/38	L = 80.0																													
A38	A	Al																												
A38/45	B																													
A38/45	L = 70.0																													
A38	A	GG																												
A38/45	B																													
A38/45	L = 80.0																													
A38/45	L = 110.0																													
A42	A	GG																												
A42/55	B																													
A42/55	L = 110.0																													
A48	A	GG																												
A48/60	B																													
A48/60	L = 110.0																													

Typ Type	Nabe Hub	Material Material	Fertigbohrung ISO-Passung H7, Nut nach DIN 6885, Blatt 1 Finish bore acc. to ISO standard H7, keyway acc. to DIN 6885, sheet 1																											
			20	22	24	25	28	30	32	35	38	40	42	45	48	50	55	60	63	65	70	75	80	85	90	100	110			
A55	A	GG																												
A55/70	B																													
A55/70	L = 140.0																													
A65	A	GG																												
A65/75	B																													
A65/75	L = 140.0																													
A75	A	GG																												
A75/90	B																													
A90	A	GG																												
A90/100	B																													
A100/110	B	GG																												

## Basisprogramm Zollbohrungen Standard inch bores

Typ Type	Nabe Hub	Material Material	V	TA	DNC	S	E	ES	ED	DNH	Ad	AS	A	G	F	B	Bs	H	Hs	Sb	Sd	Js	K	M	C	N	L	KS	NM	D	P	W
A19	A	Al	x	x	x				x	x	x	x	x																			
A19/24	B													x		x																
A19	A	GG	x	x				x	x	x			x																			
A19/24	B													x	x																	
A24	A	Al		x	x	x	x	x	x	x	x	x	x	x	x																	
A24/32	B															x	x		x	x					x							
A24	A	GG		x		x		x	x	x	x	x	x	x	x																	
A24/32	B																x				x			x	x							
A28	A	Al		x				x		x			x	x	x																	
A28/38	B																					x	x	x	x	x						
A28	A	GG								x			x	x	x																	
A28/38	B																				x	x	x	x	x							
A38	A	Al							x	x		x	x	x	x			x														
A38/45	B																															
A38	A	GG												x	x																	
A38/45	B																															
A42	A	GG												x	x									x	x	x	x					
A42/55	B																															
A48	A	GG												x	x									x	x	x	x				x	x
A48/60	B																															

Typ Type	Nabe Hub	Material Material	G	F	K	M	C	N	L	NM	DS	D	P	W	WN	WA	WK
A55	A	GG	x	x	x	x	x	x	x	x							
A55/70	B												x	x			
A65	A	GG			x	x	x	x	x			x		x			
A65/75	B														x		
A75	A	GG			x		x		x		x	x		x			
A75/90	B															x	
A90	A	GG							x		x	x					x

## Abmessungen Zollbohrungen Dimensions inch bores

Code	Ø d [mm]	b [mm]	t2 [mm]	Code	Ø d [mm]	b [mm]	t2 [mm]	Code	Ø d [mm]	b [mm]	t2 [mm]
V	11.110 H7	3.18	12.34	G	22.22 +0.030	4.75	24.70	C	38.070 +0.030	9.55	43.0
TA	12.700 +0.030	3.17	14.30	F	22.22 +0.030	6.35	25.20	N	41.290 +0.030	9.55	46.1
DNC	13.450 H7	3.17	14.90	B	25.37 +0.030	4.78	27.80	L	44.450 +0.030	11.11	49.5
S	15.870 +0.030	3.97	17.90	BS	25.38 +0.030	6.37	28.30	NM	47.625 +0.030	12.73	53.4
E	15.870 +0.030	3.17	17.50	H	25.40 +0.030	4.78	27.80	DS	50.770 +0.030	12.73	56.4
ES	15.880 +0.030	4.00	17.70	SB	28.60 +0.020	6.35	32.10	D	50.800 +0.030	12.73	55.1
Ed	15.890 +0.020	4.75	18.30	SD	28.58 +0.030	7.93	32.10	P	53.950 +0.030	12.73	59.6
DNH	17.465 H7	4.75	19.60	JS	31.75 +0.030	6.35	34.62	W	60.370 +0.030	15.87	68.8
Ad	19.020 +0.030	3.17	20.70	K	31.75 K7	7.93	35.50	WN	73.025 +0.030	19.05	83.0
AS	19.020 +0.030	4.78	21.30	KS	31.75 +0.030	7.93	36.60	WA	85.780 +0.030	22.22	97.3
A	19.050 +0.030	4.78	21.30	M	34.94 +0.030	7.93	39.00	WK	92.080 +0.030	22.22	103.3

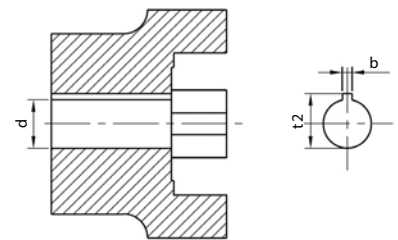

## Verzahnungsvarianten Available splines

Profil DIN 5480 Spline DIN 5480	Profil DIN 5482 Spline DIN 5482	Profil SAE Spline SAE
N 20 x 1.25 x 14 x 9 G	A 17 x 14	16/32 x 9 J 498 B
N 25 x 1.25 x 18 x 9 G	A 28 x 25	16/32 x 11 J 498 B
N 30 x 2 x 14 x 9 G	A 30 x 27	16/32 x 13 J 498 B
N 35 x 2 x 16 x 9 G	A 35 x 31	16/32 x 15 J 498 B
N 40 x 2 x 18 x 9 H	A 40 x 36	16/32 x 21 J 498 B
N 45 x 2 x 21 x 9 G	A 45 x 41	16/32 x 23 J 498 B
N 50 x 2 x 24 x 9 G	A 48 x 44	16/32 x 27 J 498 B
N 55 x 2 x 26 x 9 G	A 50 x 45	12/24 x 14 J 498 B
N 60 x 2 x 28 x 9 G	A 58 x 53	12/24 x 17 J 498 B
N 70 x 3 x 22 x 9 G	A 70 x 64	8/16 x 13 J 498 B
N 80 x 3 x 25 x 9 G		13/4 x 6 J 498 B
N 90 x 3 x 28 x 9 G		

**Kupplungs-naben mit Verzahnung sind vorzugsweise als Klemmnabe einzusetzen!**  
Erhältlich jedoch auch ohne Klemmung mit Gewindestift.

*Coupling hubs with spline are recommended as clamping hub!*  
Available also with set screw.

**Maximal zulässige Verlagerungswerte für Zahnkranzhärten 92°, 95°, 98° Shore A**  
*Max. permissible displacement values for spiders 92°, 95°, 98° Shore A*

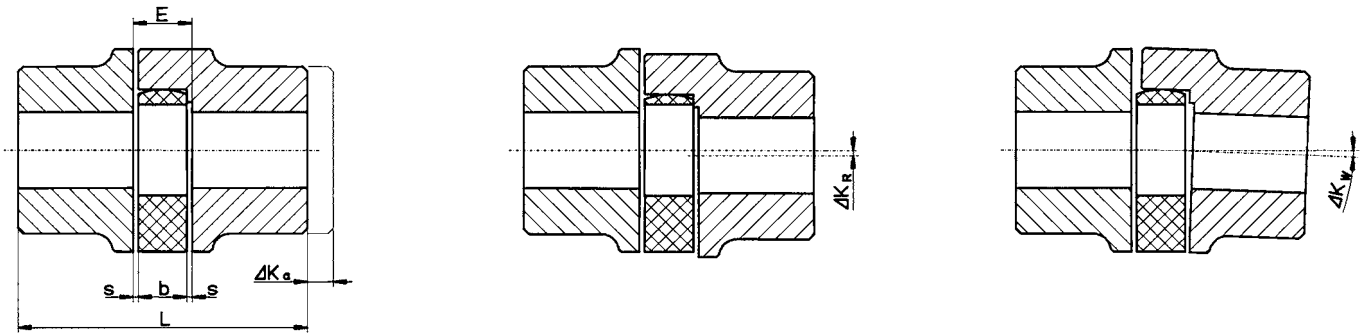

SPIDEX®	Abmessungen Dimensions [mm]				Axialversatz Axial displacement ΔKa [mm]	Radialversatz Radial displacement ΔKr [mm]				Winkelversatz Angular displacement ΔKw [°]			
	L	E	b	s		Drehzahl Rotation n [1/min]				Drehzahl Rotation n [1/min]			
						750	1000	1500	3000	750	1000	1500	3000
A14	35	13	10	1.5	1.0	0.22	0.20	0.16	0.11	1.3	1.3	1.2	1.1
A15	28	8	6	1.0	1.0	0.22	0.20	0.16	0.11	1.3	1.3	1.2	1.1
A19	66	16	12	2.0	1.2	0.27	0.24	0.20	0.13	1.3	1.3	1.2	1.1
A24	78	18	14	2.0	1.4	0.30	0.27	0.22	0.15	1.1	1.0	0.9	0.8
A28	90	20	15	2.5	1.5	0.34	0.30	0.25	0.17	1.1	1.0	0.9	0.8
A38	114	24	18	3.0	1.8	0.38	0.35	0.28	0.19	1.1	1.1	1.0	0.8
A42	126	26	20	3.0	2.0	0.43	0.38	0.32	0.21	1.1	1.1	1.0	0.8
A48	140	28	21	3.5	2.1	0.50	0.44	0.36	0.25	1.2	1.2	1.1	0.9
A55	160	30	22	4.0	2.2	0.54	0.46	0.38	0.26	1.2	1.2	1.1	1.0
A65	185	35	26	4.5	2.6	0.56	0.50	0.42	0.28	1.2	1.2	1.2	1.0
A75	210	40	30	5.0	3.0	0.65	0.58	0.48	0.32	1.3	1.2	1.2	1.0
A90	245	45	34	5.5	3.4	0.68	0.60	0.50	0.34	1.3	1.3	1.2	1.1
A100	270	50	38	6.0	3.8	0.71	0.64	0.52	0.36	1.3	1.3	1.2	1.1
A110	295	55	42	6.5	4.2	0.75	0.67	0.55	0.38	1.3	1.3	1.3	1.1
A125	340	60	46	7.0	4.6	0.80	0.70	0.60	-	1.3	1.3	1.3	-

- Das Längenmaß L vergrößert sich um die angegebenen ΔKa-Werte.
- Die aufgeführten Verlagerungswerte sind allgemeine Richtwerte.
- Bei gleichzeitigem Winkel- und Radialversatz können die angegebenen Werte nur anteilmäßig ausgenutzt werden.
- Die Tabellenwerte sind gültig für eine Betriebstemperatur T = +30 °C. Bei einer Temperaturerhöhung müssen die max. zulässigen Radial- und Winkelverlagerungswerte mit dem Temperaturfaktor St multipliziert werden.

- The dimension L increases by the given ΔKa values.
- The above mentioned displacement values are general guidelines.
- In case of angular and radial displacements, the values can only be used proportionately.
- The values are valid for an operating temperature of T = +30°C. If the temperature increases, the permissible radial and simultaneous angular displacement values must be multiplied by the temperature factor St.

Temperatur T Temperature T	-40 < +30 °C	+30 < +40 °C	+40 < +60 °C	+60 < +80 °C	+80 °C <
Faktor St Factor St	1.0	0.8	0.7	0.6	0.3

Sorgfältiges Ausrichten der Wellen erhöht die Lebensdauer der Kupplung  
**Achtung: Montageanleitung beachten**

Careful alignment will extend the coupling life  
**Caution: observe the assembly instructions**

**Kegelige Bohrungen**  
*Taper bores*

Code	Konus 1:8 Taper 1:8			
	Ø d	b	t2	l
...N/1	9.750	2.40	10.70	17.0
...N/1c	11.600	3.00	12.90	16.5
...N/1e	13.000	2.40	13.80	21.0
...N/1d	14.000	3.00	15.50	17.5
...N/1b	14.300	3.20	15.65	19.5
...N/2	17.287	3.20	18.24	24.0
...N/2a	17.287	4.00	18.94	24.0
...N/2b	17.287	3.00	18.24	24.0
...N/3	22.002	3.99	23.40	28.0
...N/4	25.463	4.78	28.86	36.0
...N/4b	25.463	5.00	28.23	36.0
...N/4a	27.000	4.78	28.80	32.5
...N/4g	28.450	6.00	29.33	38.5
...N/5	33.176	6.38	35.39	44.0
...N/5a	33.176	7.00	35.39	44.0
...N/6	43.057	7.95	46.46	51.0
...N/6a	41.150	8.00	44.25	42.0

Code	Konus 1:5 Taper 1:5			
	Ø d	b	t2	l
A10	9.85	2	10.85	11.5
As12	11.85	3	13.65	16.5
B17	16.85	3	18.90	18.5
C20	19.85	4	22.05	21.5
Cs22	21.95	3	23.75	21.5
D25	24.85	5	27.90	26.5
E30	29.85	6	32.45	31.5
F35	34.85	6	37.45	36.5
G40	39.85	6	42.45	41.5

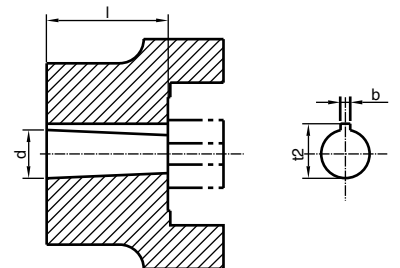

**SPIDEX® NBL – spielfreie Wellenkupplung**  
**SPIDEX® NBL – backlash-free shaft coupling**

- Unter Vorspannung spielfreie Wellenverbindung
  - Kleine Baumaße – geringe Schwungmomente
  - Wartungsfrei
  - Verschiedene Elastomerhärten der Zahnkränze (s.S. 18)
  - Fertigbohrung nach ISO-Passung H7 (ausgenommen Klemmnabe), Passfedernut ab Ø 6 mm nach DIN 6885 Bl. 1 -JS9
- 
- Backlash-free, pre-stressed shaft connection
  - Compact dimensions – low moment of inertia
  - Maintenance-free
  - Spiders with various levels of elastomer hardness (see p. 18)
  - Finish bore in accordance with ISO fit H7 (except clamping hub), keyway from Ø 6 mm in accordance with DIN 6885 sheet 1 - JS9

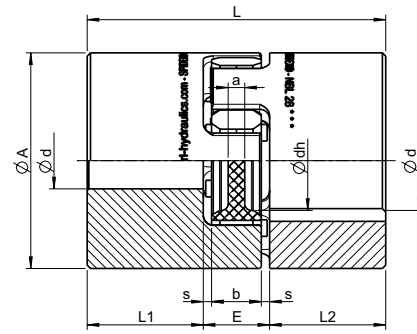

SPIDEX® NBL 9 – 55

**Nabenausführungen**  
**Types of hubs**

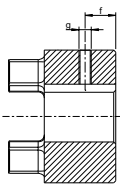

**Standard: mit Passfedernut und Gewindestift**  
*Standard with keyway and set screw*

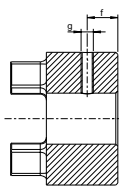

**Standard ON: ohne Passfedernut mit Gewindestift**  
*Standard ON without keyway and set screw*

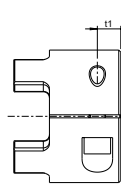

**KL: Größen 9 bis 14, einfach geschlitzte Klemmnabe ohne Passfedernut, Drehmoment abhängig vom Bohrungs-Ø.**  
*KL: sizes 9 to 14, single-slot clamping hub without keyway, torque dependent on bore diameter/Ø.*

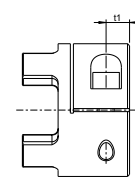
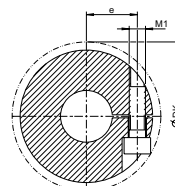

**KLD: ab Größe 19, 2-fach geschlitzte Klemmnabe ohne Passfedernut, Drehmoment abhängig vom Bohrungs-Ø.**  
*KLD: from size 19, double-slot clamping hub without keyway, torque dependent on bore diameter/Ø.*

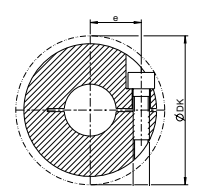

**SPIDEX® NBL Standardbauarten** (Größen 9 – 38: Nabenwerkstoff Aluminium / Größen 42 – 55: Nabenwerkstoff Stahl)  
**SPIDEX® NBL standard versions** (sizes 9 – 38: hub material aluminium / sizes 42 – 55: hub material steel)

Größe Size	Maximale Fertigbohrung Ø d für Nabenausführung Maximum finish bore Ø d for hub version		Abmessungen [mm] Dimensions [mm]								Gewindestift DIN 916 für Standardausführung mit und ohne Nut Set screw DIN 916 for standard version with and without keyway		Klemmschraube DIN 912 für Nabenausführung KL und KLD mit und ohne Nut Clamping screw DIN 912 for hub version KL and KLD with and without keyway				
	Standard	KL/KLD	A	d <sub>H</sub>	L	L1/L2	E	b	s	a	g	t	M <sub>1</sub>	t <sub>1</sub>	e	D <sub>K</sub>	T <sub>A</sub> [Nm]
9	11	11	20	7.2	30	10	10	8	1.0	1.5	M4	5	M2.5	5.0	7.5	23.4	0.76
14	16	16	30	10.5	35	11	13	10	1.5	2.0	M4	5	M3	5.0	11.5	32.2	1.34
19	24	24	40	18.0	66	25	16	12	2.0	3.0	M5	10	M6	11.0	14.5	46.0	10.50
24	28	28	55	27.0	78	30	18	14	2.0	3.0	M5	10	M6	10.5	20.0	57.5	10.50
28	38	38	65	30.0	90	35	20	15	2.5	4.0	M8	15	M8	11.5	25.0	73.0	25.00
38	45	45	80	38.0	114	45	24	18	3.0	4.0	M8	15	M8	15.5	30.0	83.5	25.00
42	55	50	95	46.0	126	50	26	20	3.0	4.0	M8	20	M10	18.0	32.0	93.5	69.00
48	62	55	105	51.0	140	56	28	21	3.5	4.0	M8	20	M12	21.0	36.0	105.0	120.00
55	74	68	120	60.0	160	65	30	22	4.0	4.5	M10	20	M12	26.0	42.5	119.5	120.00

**KL.../ON Übertragbare Reibschlussmomente T<sub>R</sub> [Nm] der Klemmnabe ohne Passfedernut**  
**KL.../ON Transmissible friction torque values T<sub>R</sub> [Nm] of the clamping hub without keyway**

Größe Size	Ø4	Ø5	Ø6	Ø7	Ø8	Ø9	Ø10	Ø11	Ø12	Ø14	Ø15	Ø16
9	2.1	2.2	2.3	2.4	2.5	2.6	2.7	2.8				
14		4.7	4.8	5.0	5.1	5.3	5.5	5.6	5.8	6.1	6.3	6.5

**KLD.../ON Übertragbare Reibschlussmomente T<sub>R</sub> [Nm] der Klemmnabe ohne Passfedernut**  
**KLD.../ON Transmissible friction torque values T<sub>R</sub> [Nm] of the clamping hub without keyway**

Größe Size	Ø8	Ø10	Ø11	Ø14	Ø15	Ø16	Ø18	Ø19	Ø20	Ø22	Ø24	Ø25	Ø28	Ø30	Ø32	Ø35	Ø38	Ø40	Ø42	Ø45	Ø48	Ø50	Ø55	Ø60	Ø65
19	25	27	27	29	30	31	32	32	34	30 <sup>1)</sup>	32 <sup>1)</sup>														
24		34	35	36	38	38	39	40	41	42	43	45	46												
28				80	81	81	84	85	87	89	91	92	97	99	102	105	109								
38					92	94	97	98	99	102	104	105	109	112	113	118	122	123	126	130					
42										232	238	244	246	255	260	266	274	283	288	294	301	309	315		
48												393	405	413	421	434	445	454	462	473	486	494	414		
55														473	486	498	507	514	526	539	547	567	587	608	

1) Klemmnabe 1-fach geschlitzt mit 2 x Klemmschrauben M4 und Maß e = 15  
1) Single-slot clamping hub with 2 x clamping screws M4 and dimension e = 15



**NBL-Zahnkränze**  
*NBL spiders*



**Zahnkranz Polyurethan**  
**92° Shore A NBL**  
*Spider polyurethane*  
**92° Shore A NBL**

- Gelb *Yellow*
- Dauertemperatur -40 bis +90 °C  
*Continuous temperature -40 to +90 °C*
- Max. Temperatur kurzzeitig -50 bis +120 °C  
*Max. short-term temperature -50 to +120 °C*
- Für Antriebe von elektrischen Mess- und Regelsystemen  
*For drives of electrical measurement & control systems*

**Zahnkranz Polyurethan**  
**98° Shore A NBL**  
*Spider polyurethane*  
**98° Shore A NBL**

- Rot *Red*
- Dauertemperatur -30 bis +90 °C  
*Continuous temperature -30 to +90 °C*
- Max. Temperatur kurzzeitig -40 bis +120 °C  
*Max. short-term temperature -40 to +120 °C*
- Positionierantriebe  
*Positioning motors*
- Hauptspindelantriebe bei hoher Beanspruchung  
*Main spindle drives with high loads*

**Zahnkranz Polyurethan**  
**64° Shore D NBL**  
*Spider polyurethane*  
**64° Shore D NBL**

- Grün *Green*
- Dauertemperatur -20 bis +110 °C  
*Continuous temperature -20 to +110 °C*
- Max. Temperatur kurzzeitig -30 bis +120 °C  
*Max. short-term temperature -30 to +120 °C*
- Hohe Belastbarkeit mit geringem Verdrehwinkel  
*High loading with low torsion angle*

**Technische Daten**  
*Technical data*

Größe Size	Zahnkranz Spider	Drehmoment Torque [Nm]		Max. Drehzahl Max. RPM n [1/min]		Statische Drehfedersteife Static torsional rigidity [Nm/rad] bei 0.50 T <sub>KN</sub>	Dynamische Drehfedersteife Dynamic torsional rigidity [Nm/rad] bei 0.50 T <sub>KN</sub>	Radiale Steifigkeit Radial rigidity [Nm/mm]	Gewicht Weight [kg]		Massenträgheitsmoment J Moment of inertia J [kg m <sup>2</sup> ]	
		Nenn Contin. T <sub>KN</sub>	Maximal Maximum T <sub>Kmax</sub>	Standard Standard	KL/KLD				Nabe Hub (x 10 <sup>-3</sup> )	Zahnkranz Spider (x 10 <sup>-3</sup> )	Nabe Hub (x 10 <sup>-6</sup> )	Zahnkranz Spider (x 10 <sup>-6</sup> )
NBL9	92° Shore A	3.0	6.0	19000	23800	31.5	95	262	8	1.7	0.480	0.085
	98° Shore A	5.0	10.0			51.6	155	518				
NBL14	92° Shore A	7.5	15.0	12700	15900	114.6	344	336	20	4.6	2.800	0.457
	98° Shore A	12.5	25.0			171.9	513	654				
NBL19	92° Shore A	10.0	20.0	9550	11900	573.0	1720	1120	66	7.0	20.400	1.490
	98° Shore A	17.0	34.0			859.5	2580	2010				
NBL24	92° Shore A	35.0	70.0	6950	8850	1432.0	4296	1480	132	18.0	50.800	7.500
	98° Shore A	60.0	120.0			2063.0	6189	2560				
	64° Shore D	75.0	150.0			2978.0	8934	3696				
NBL28	92° Shore A	95.0	190.0	5850	7350	2292.0	6876	1780	253	29.0	200.300	16.500
	98° Shore A	160.0	320.0			3438.0	10314	3200				
	64° Shore D	200.0	400.0			4350.0	13050	4348				
NBL38	92° Shore A	190.0	380.0	4750	5950	4584.0	13752	2350	455	49.0	400.600	44.600
	98° Shore A	325.0	650.0			7160.0	21486	4400				
	64° Shore D	405.0	810.0			10540.0	31620	6474				
NBL42	92° Shore A	265.0	530.0	4000	5000	6300.0	14490	2430	1850	79.0	2246.000	100.000
	98° Shore A	450.0	900.0			19200.0	48000	5570				
	64° Shore D	560.0	1120.0			27580.0	68950	7270				
NBL48	92° Shore A	310.0	620.0	3600	4550	7850.0	18055	2580	2520	98.0	3786.000	200.000
	98° Shore A	525.0	1050.0			22370.0	55925	5930				
	64° Shore D	655.0	1310.0			36200.0	90500	8274				
NBL55	92° Shore A	410.0	820.0	3150	3950	9500.0	21850	2980	3800	115.0	7496.000	300.000
	98° Shore A	685.0	1370.0			23800.0	59500	6686				
	64° Shore D	825.0	1650.0			41460.0	103650	9248				

**Bestellbezeichnungen für SPIDEX® NBL**  
*Order description for SPIDEX® NBL*

SPIDEX® KLD AI NBL 38/45 25H7 ON L = 20 SO

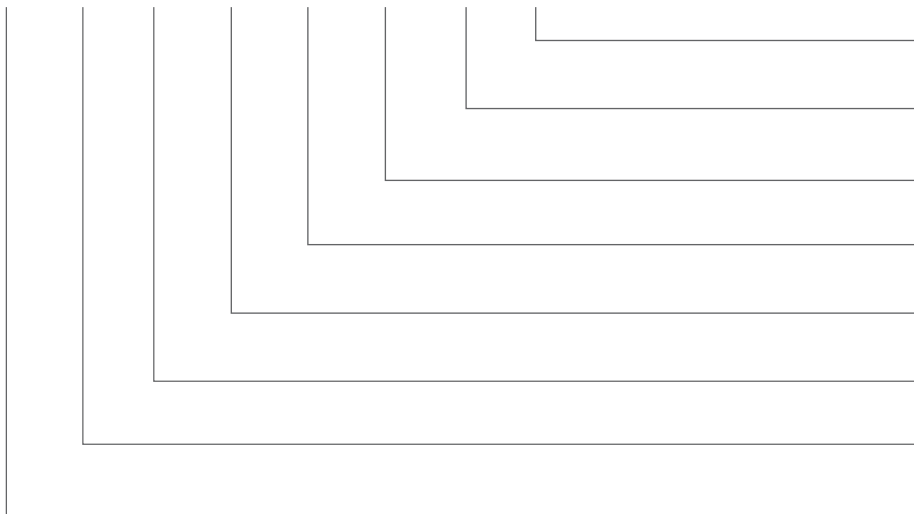

- Sonderausführungen  
*Special designs*
- Nabenlänge  
*Length of hub*
- Nabenbohrung, Zusatz  
*Hub bore, supplement*
- Nabenbohrung, Grundform  
*Hub bore, basic form*
- Baugröße  
*Size*
- Typ  
*Type*
- Nabenwerkstoff  
*Material of hub*
- Nabenausführung  
*Design of hub*

**Erläuterung zum Bestellschlüssel** *Explanation of order code*

**Nabenausführungen** *Design of hubs*

Ausführung <i>Design</i>	Bestellschlüssel <i>Order code</i>	Beschreibung <i>Description</i>	Beispiel <i>Example</i>
Standard <i>Standard</i>	-	- zylindrische Bohrung <b>mit</b> Passfedernut nach DIN 6885/1 <i>- cylindrical bore with keyway in accordance with DIN 6885/1</i>	
	...-ON	- zylindrische Bohrung <b>ohne</b> Passfedernut <i>- cylindrical bore without keyway</i>	
Klemmnabe, einfach geschlitzt <i>Clamping hub, single slot</i>	KL	- zylindrische Bohrung <b>mit</b> Passfedernut nach DIN 6885/1 - Nabe einfach geschlitzt mit seitlicher Klemmschraube <i>- cylindrical bore with keyway in accordance with DIN 6885/1 - single-slot hub with lateral clamping screw</i>	
	KL-...-ON	- zylindrische Bohrung <b>ohne</b> Passfedernut - Nabe einfach geschlitzt mit seitlicher Klemmschraube <i>- cylindrical bore without keyway - single-slot hub with lateral clamping screw</i>	
Klemmnabe, doppelt geschlitzt <i>Clamping hub, double slot</i>	KLD	- zylindrische Bohrung <b>mit</b> Passfedernut nach DIN 6885/1 - Nabe doppelt geschlitzt mit seitlicher Klemmschraube <i>- cylindrical bore with keyway in accordance with DIN 6885/1 - double-slot hub with lateral clamping screw</i>	
	KLD-...-ON	- zylindrische Bohrung <b>ohne</b> Passfedernut - Nabe doppelt geschlitzt mit seitlicher Klemmschraube <i>- cylindrical bore without keyway - double-slot hub with lateral clamping screw</i>	



**NOTES**

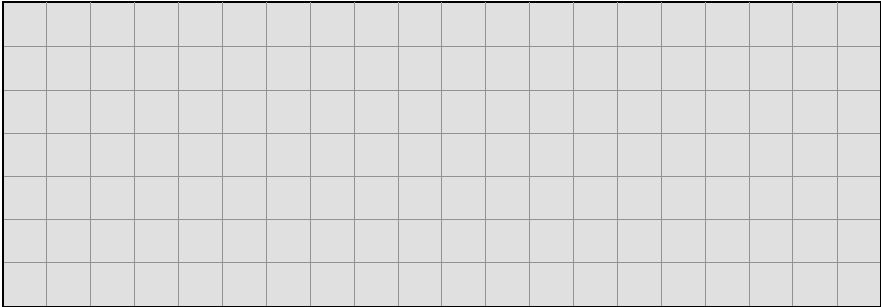

# SEEKING PARTNER:



Møllegaardsens Grafisk · 20 49 89 61 · www.mgrafisk.dk

## MADE IN DENMARK

**TECHNOFLEX**  
POWER TO PERFORM



**TECHNOFLEX®**

Industrivej 21

DK-8653 Them

tlf. +45 8724 4545

[www.technoflex.dk](http://www.technoflex.dk)