

Quality never becomes waste

d line

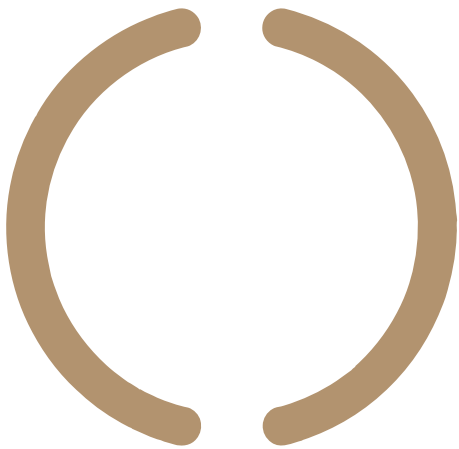

We challenge you to make the
highly enduring choice.

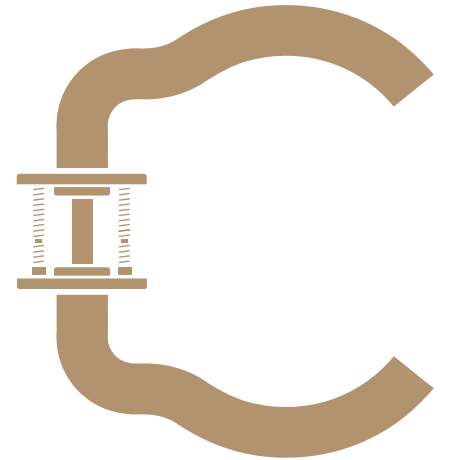

Re-handle®

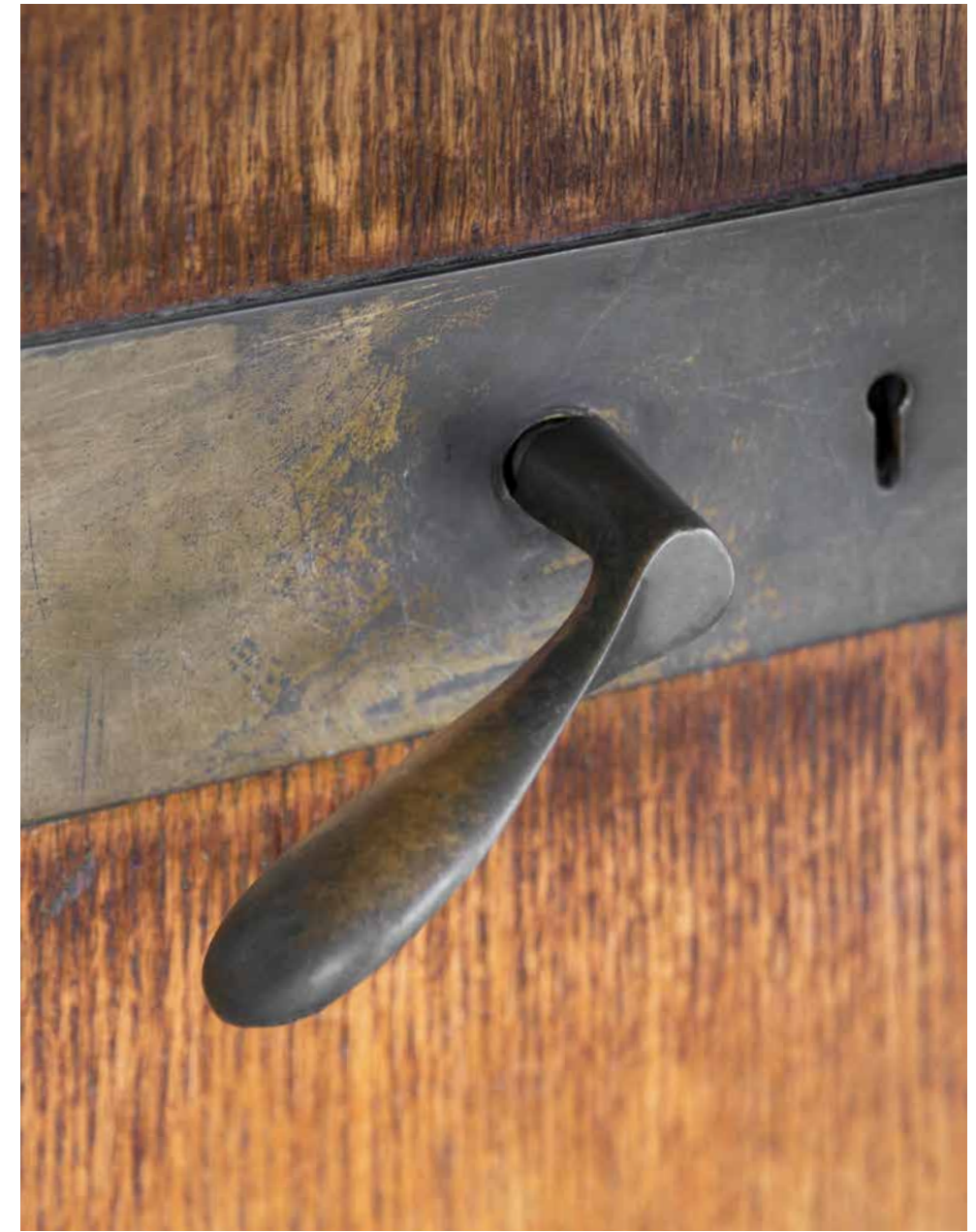

Re-handle



Designed to never become waste

The industry's first circular system that will **prolong the life** of products up to 100 years.

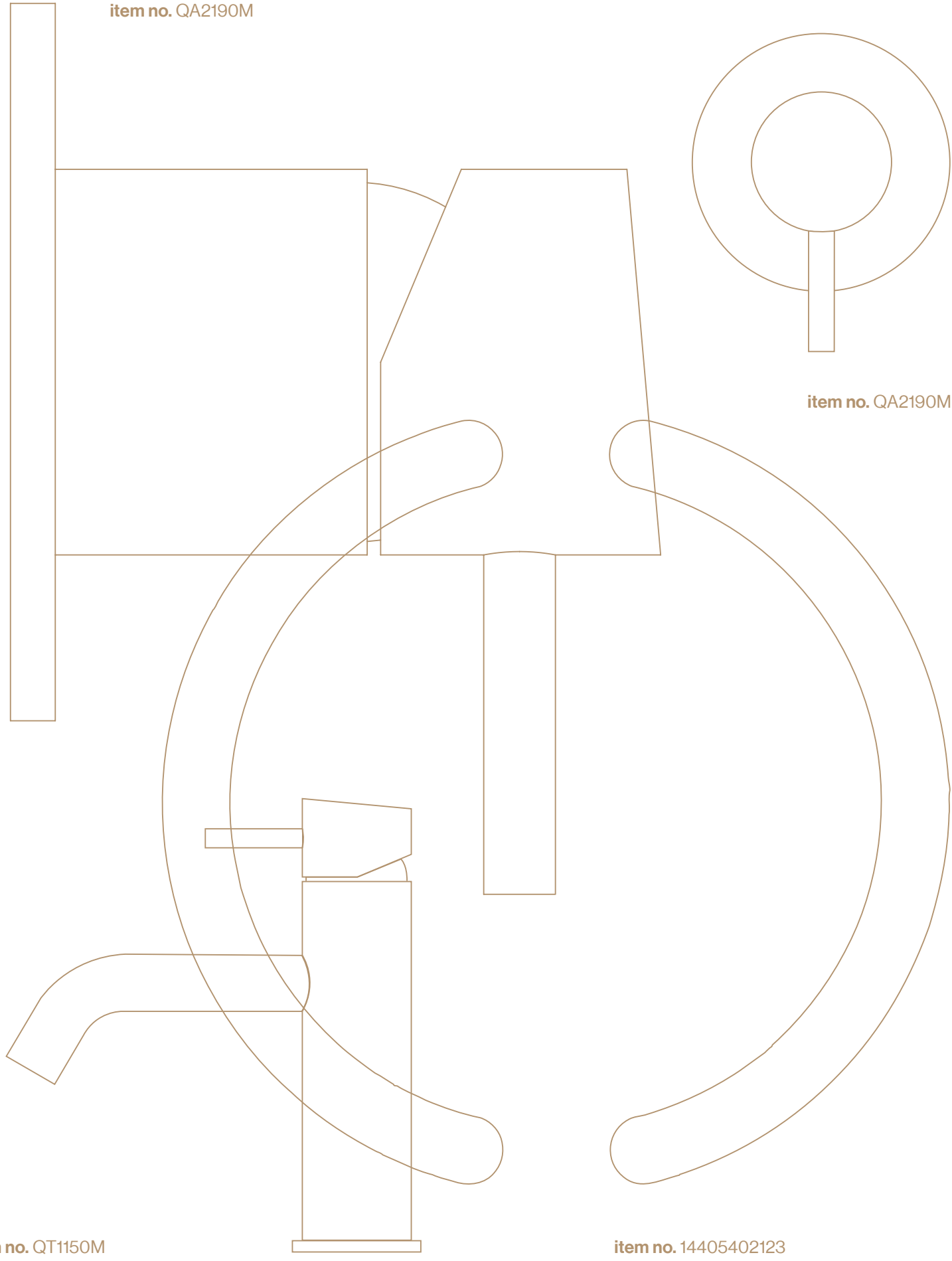

Purpose:

we challenge you
to make the highly
enduring choice.

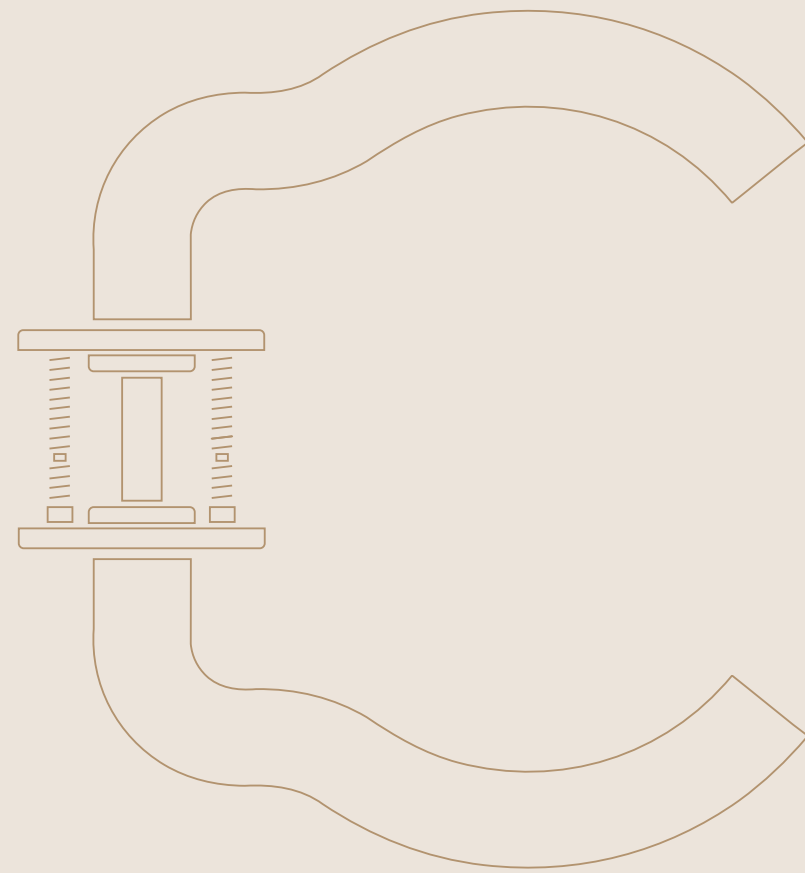

item no. 14131602015

Index

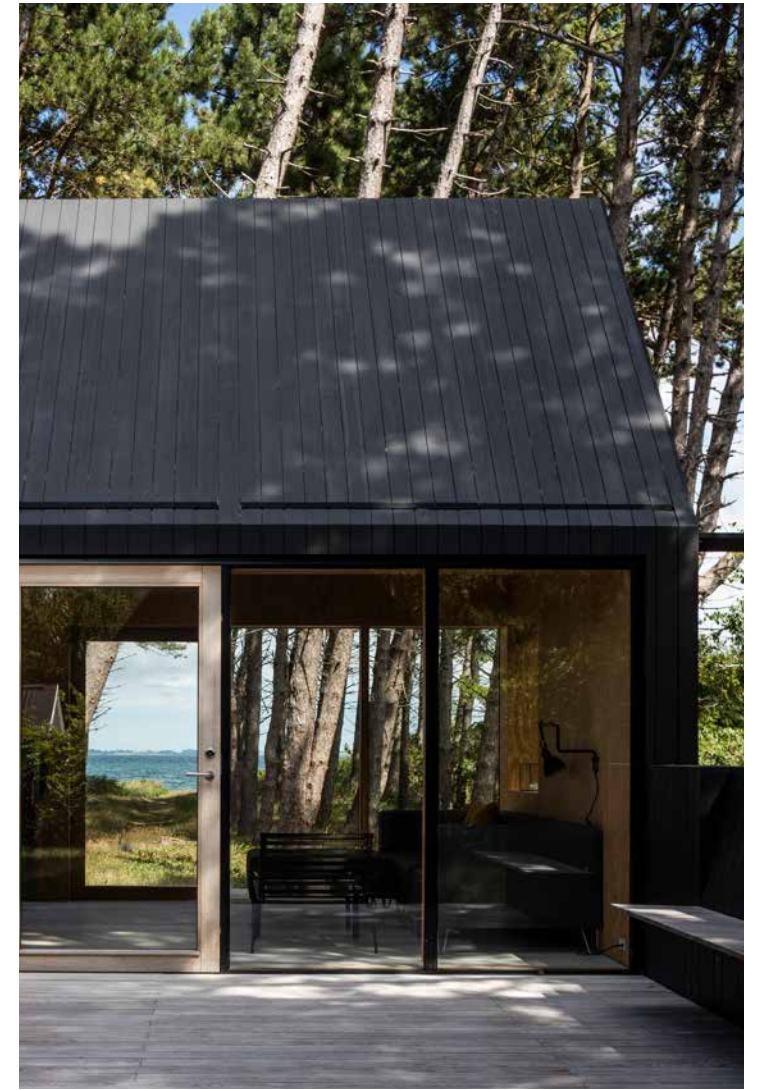

01 Introduction **02** Re-handle your
product **03** Environmental product
declarations **04** Production
05 Sourcing, processing and recycling
06 Ambitions **07** Stories

Introduction



That which is simple never goes out of style and that of uncompromising quality never needs to be bought for a purpose more than once.

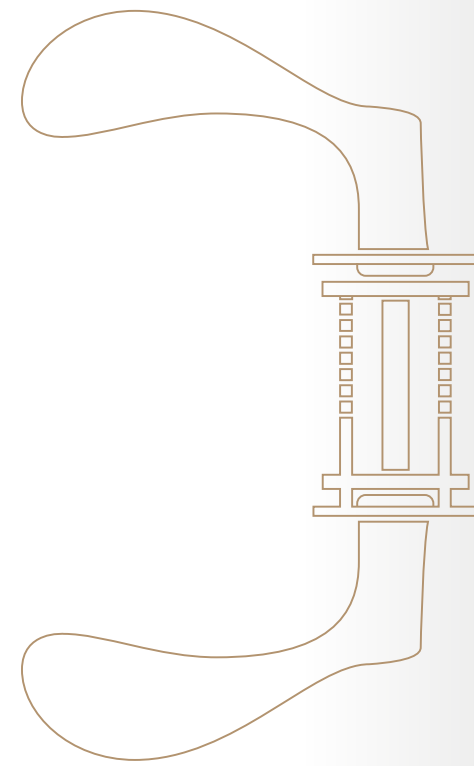

item no. 12404474030

d line Re-handle

Designed to endure

We place enormous value on our products' reputation for standing the test of time, because we believe that anything that's less than superb in its design and craftsmanship is simply a waste – not just of money but also of resources. It is based on unfussy, minimalist design that will never date. And it is based on the use of raw, resilient, acid-proof, non-corrosive AISI 316, as the strongest, most hard-wearing steel for these types of purposes.

Today our commitment to the world exists as a 20-year guarantee on our products. This commitment extends to responsible sourcing of our steel, to ISO 14001 certified in-house prod-

uction facilities and now also to a product, that can be Re-handled up to four times, so that it can endure for 100 years. Each Re-handle product also comes with a full disclosure of carbon footprint, to underline exactly what the global warming potential is on reusing compared with producing new.

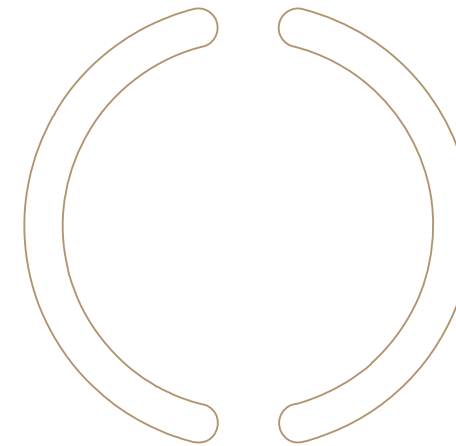

item no. 14405402123

d line Re-handle



Product

- 20-year product warranty, renewed at every Re-handle.
- EPDs with full declaration on 40% of our portfolio.
- Re-handle possibility on 250 items.
- Reduce the Global Warming Potential between 54-91% with each Re-handle.
- 100% recyclable AISI 316 stainless steel.
- Recycled and recyclable packaging.

Production

- In-house production facilities (complete supply chain control).
- Local sourcing.
- All waste is carefully sorted and 100% recycled.
- 0.3% production failures.
- ISO 14001 certified facilities.

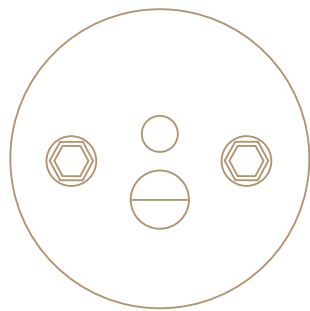

item no. 14347002306

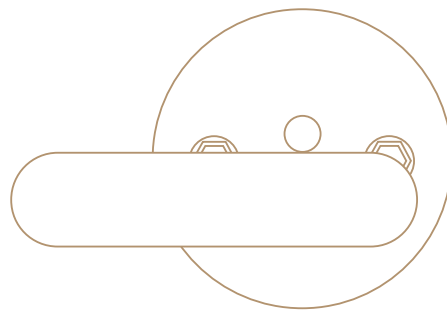

item no. 14347802300

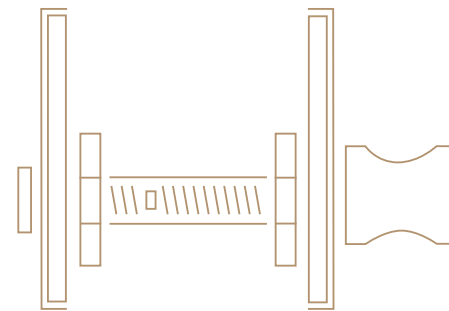

item no. 14347502457

Our product is based on the use of raw, resilient, acid-proof, non-corrosive **AISI 316**, as the strongest, most hard-wearing steel.



Re-handle your product

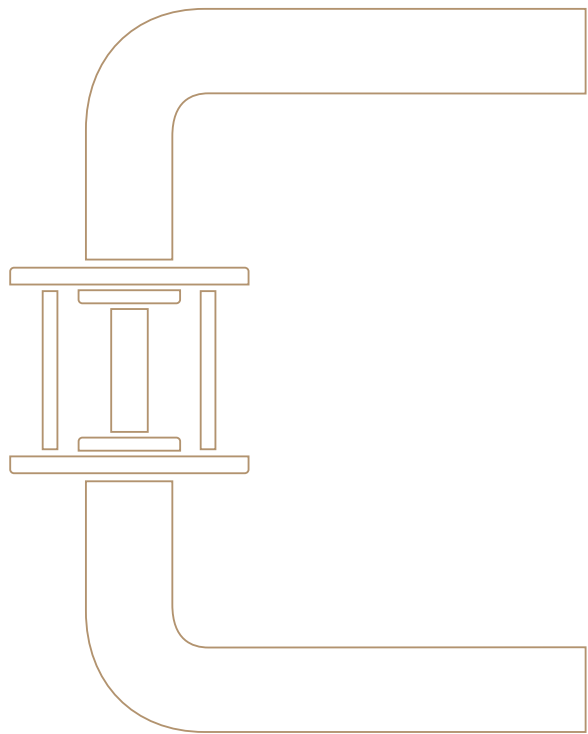

d line products are not only made to be used, **they're made to last.** This is why we take in original products to be Re-handled.

d line – made to endure

item no. 14041602011

02

Sometimes good as new is better

Low quality is a waste of resources. We challenge you to Re-handle the same product up to four times. With each Re-handle the 20-year product warranty period is renewed, securing 100 years of use.

Designed to never become waste

Long before global warming became an issue of concern, d line made a promise that we would create things that are timeless in their design and enduring in their strength, so that they wouldn't need to be bought for a purpose more than once. It is this uncompromising approach to design and our complete supply chain control, that makes Re-handle the most revolutionary circular system in our operating industry.



We fix, replace and brush your product to work good as new. With each Re-handle, we save the environment up to **91% CO₂ emission.**



Reuse in order to reduce

We know that every new product put into the world has severe CO₂ impacts. By choosing to Re-handle our products instead of producing new, you will dramatically reduce the carbon footprint between 54-91%, depending on the product.

We know this, because we have documented our products' complete Global Warming Potential (CO₂ emission) across the entire life cycle, based on internationally recognized Environmental Product Declarations (EPDs executed and verified by third party).

- Reduced carbon footprint (GWP) between 54-91%.
- 20-year warranty period renewed at every Re-handle.
- 60% cost saving per Re-handle.
- Re-handle possibility on 250 items.

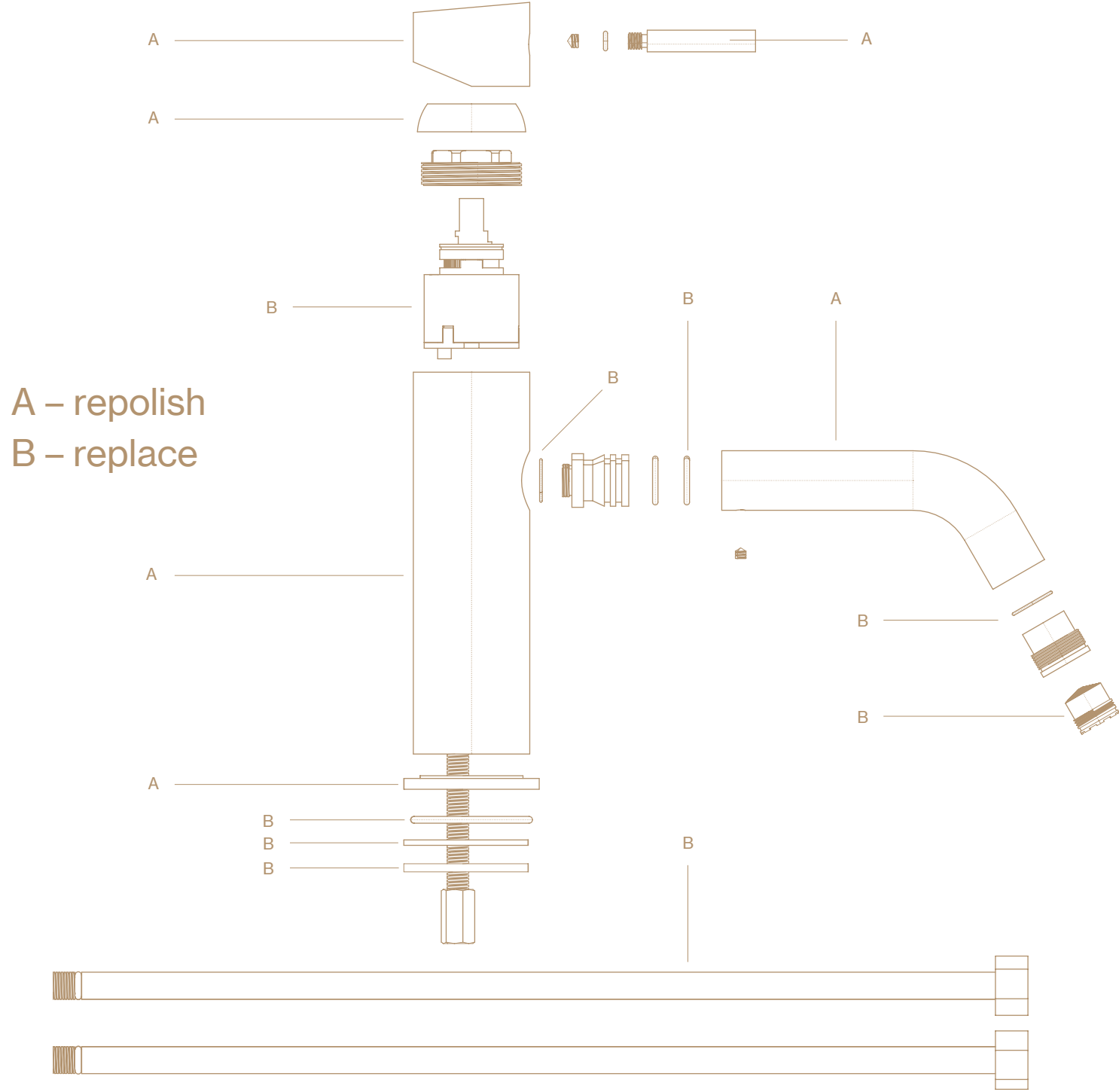

Qtoo
collection

Product
Single hole tap

item no.
#QT1150M

QTOO collection, single lever tap, 130mm projection. Manufactured in the highest quality marine grade, AISI 316 stainless steel, protecting against high levels of corrosion. 20-year warranty

LCA

Re-handle® LCA

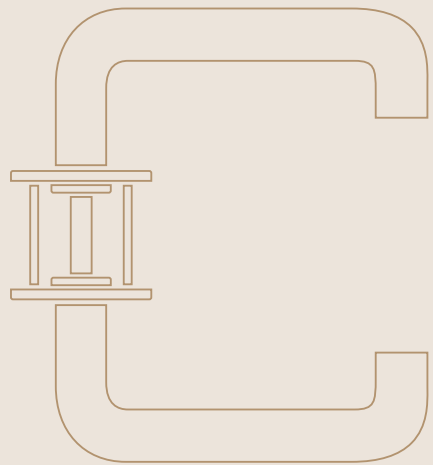

item no. 14051602017

Lever handles

4.21 kg. CO₂

Pull handles

4.84 kg. CO₂

Toilet indicators, tumb turns & escutcheons

0.87 kg. CO₂

Taps, external fixtures & wastes

10.8 kg. CO₂

Built-in tap, shower & bath tub sets

63.43 kg. CO₂

item no. QT1150M

Average kg. CO₂ emission per category.

62% less emission

1.59 kg. CO₂

84% less emission

0.75 kg. CO₂

54% less emission

0.40 kg. CO₂

91% less emission

0.95 kg. CO₂

81% less emission

12.23 kg. CO₂

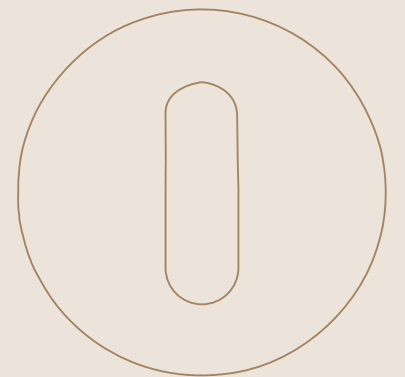

item no. 14343602139

Environmental product declarations

By Re-handling our products, you will dramatically lower their global warming potential between 54-91%.

03

Making highly enduring choices

In this waste-aware environment, Architects and Specifiers look for solutions that are fully documented and thought within their built environment. Now more than ever, we see a movement towards data-driven and future-thinking decision making. Whilst Environmental Product Declarations (EPDs) are a powerful tool for taking into account energy and resource consumption as well as environmental impacts over the entire life cycle of a product, it requires that a product is fully declared across the entire life cycle in order to make fully informed decisions. Today, it is only mandatory to declare the product in its production phase, thus losing out on vital information across the remaining life cycle, such as use, end of life and recycling.

We have made it our mission to challenge the industry for undercutting decision makers with correct data and have for that reason decided to fully disclose the complete global warming potential (GWP) of more than 40% of our portfolio. This means full declaration across its entire product life cycle, from production, use, refurbishment and right through to recycling. That's how we can confidently state, that by Re-handling a d line product, you will dramatically reduce the carbon footprint between 54-91% depending on the product, compared with producing new.



What to look for in an EPD

We recommend that you assess a product's performance based on the values in the Global Warming Potential (GWP), that shows how many kg. CO₂ is released into the atmosphere when producing 1kg of declared product. Factoring in the total product weight is therefore crucial to understand a product's complete GWP. The more weight of the product, the higher the global warming potential (or CO₂ emission) is. The GWP in section A1 to A3 is directly related to the CO₂ emissions in the conception of a

product (production phase). Section B5 Refurbishment is, on the contrary, the values of restoring that same product, to keep it in its life cycle. By comparing these to figures, you can calculate exactly what impact a Re-handled product has, compared to producing new.

Why comparing EPD's across alternative goods can be misleading

Although the perfect way to make sustainable choices is to compare EPD's across alternative goods, there are current challenges with the way

we work with EPD's today, which hinders Architects and Specifiers to make fully informed decisions.

- Firstly, the declaration only declares a products' potential impact and does not assess whether this is high or low, hence a comparison of alternative goods is required.
- Secondly, the standard does not require full declaration of a products' impact, therefore we can never compare EPD's across goods, unless both are fully declared.
- Thirdly, the global warming potential is influenced by the product weight.

The more weight, the higher the global warming potential of a product. Often lesser quality products will have lower weight, because they are not made to last. By choosing to only declare the product production phase (A1-A3), a lower quality product with short life span will most likely have the lowest environmental impact.

Consequently, EPDs are missing one vital information and that is expected life span. We prefer solid stainless steel AISI 316, because of its endurance and recyclability. Heavy weight

increases the global warming potential, and so we need to include expected life span and Re-handle possibilities. That's also why our products must have transparency with regards to their complete global warming potential (GWP). This means full declaration across its entire product life cycle. This is the only way we can help Architects and Specifiers make fully informed decisions.

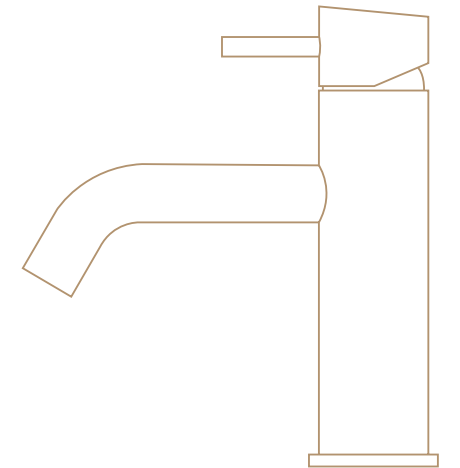

item no. QT1150M

Potential environmental impact – according to EN15804, for d line taps, external fixtures & wastes

Results per functional or declared unit							
		Raw material supply, transport & manufacturing	Transport	Construction installation	Use	Maintenance	Repair
Indicator	Unit	A1-A3	A4	A5	B1	B2	B3
GWP-fossil	kg CO ₂ eq.	6,98E+00	2,94E+00	5,56E-3	0,00E+00	0,00E+00	0,00E+00
GWP-biogenic	kg CO ₂ eq.	2,98E-2	9,85E-4	3,74E-3	0,00E+00	0,00E+00	0,00E+00
GWP-luluc	kg CO ₂ eq.	1,05E-2	1,94E-4	2,25E-6	0,00E+00	0,00E+00	0,00E+00
GWP-total	kg CO ₂ eq.	7,02E+00	2,92E+00	9,3E-3	0,00E+00	0,00E+00	0,00E+00
ODP	kg CFC 11 eq.	3,97E-7	6,68E-7	8,04E-10	0,00E+00	0,00E+00	0,00E+00
AP	mol H+ eq.	4,03E-2	1,54E-2	3,24E-5	0,00E+00	0,00E+00	0,00E+00
EP-freshwater	kg P eq.	3,18E-4	6,79E-6	9,77E-8	0,00E+00	0,00E+00	0,00E+00
EP-marine	kg N eq.	7,23E-3	5,61E-3	1,14E-5	0,00E+00	0,00E+00	0,00E+00
EP-terrestrial	mol N eq.	7,91E-2	6,15E-2	1,21E-4	0,00E+00	0,00E+00	0,00E+00
POCP	kg NMVOC eq.	2,56E-2	1,59E-2	4,19E-5	0,00E+00	0,00E+00	0,00E+00
ADP-minerals & metals*	kg Sb eq.	2,09E-4	4,1E-6	1,87E-7	0,00E+00	0,00E+00	0,00E+00
ADP-fossil*	MJ	7,72E+01	4,15E+01	6,28E-2	0,00E+00	0,00E+00	0,00E+00
WDP*	m3	5,80E+00	3,75E-2	4,9E-4	0,00E+00	0,00E+00	0,00E+00

Acronyms:

GWP-fossil = Global Warming Potential fossil fuels; **GWP-biogenic** = Global Warming Potential biogenic; **GWP-luluc** = Global Warming Potential land use and land use change; **ODP** = Depletion potential of the stratospheric ozone layer; **AP** = Acidification potential, Accumulated Exceedance; **EP-freshwater** = Eutrophication potential, fraction of nutrients reaching freshwater end compartment; **EP-marine** = Eutrophication potential, fraction of nutrients reaching marine end compartment; **EP-terrestrial** = Eutrophication potential, Accumulated Exceedance; **POCP** = Formation potential of tropospheric ozone; **ADP-minerals&metals** = Abiotic depletion potential for non-fossil resources; **ADP-fossil** = Abiotic depletion for fossil resources potential; **WDP** = Water (user) deprivation potential, deprivation-weighted water consumption.

Results per functional or declared unit								
Replacement	Refurbishment	Operational energy use	Operational water use	De-construction demolition	Transport	Waste processing	Disposal	Reuse-Recovery-Recycling-potential
B4	B5	B6	B7	C1	C2	C3	C4	D
0,00E+00	6,01E-1	0,00E+00	0,00E+00	0,00E+00	4,54E-3	2,56E-2	3,24E-3	-8,23E-1
0,00E+00	1,15E-2	0,00E+00	0,00E+00	0,00E+00	3,3E-6	-1,52E-3	1,23E-6	8,44E-3
0,00E+00	2,69E-3	0,00E+00	0,00E+00	0,00E+00	1,37E-6	3,01E-5	1,73E-7	9,35E-4
0,00E+00	6,16E-1	0,00E+00	0,00E+00	0,00E+00	4,55E-3	2,42E-2	3,24E-3	-8,13E-1
0,00E+00	1,23E-7	0,00E+00	0,00E+00	0,00E+00	1,07E-9	3,13E-9	2,23E-10	-2,12E-8
0,00E+00	3,03E-3	0,00E+00	0,00E+00	0,00E+00	1,91E-5	2,84E-4	5,62E-6	-3,16E-3
0,00E+00	1,15E-5	0,00E+00	0,00E+00	0,00E+00	3,7E-8	1,49E-6	7,07E-9	-2,99E-5
0,00E+00	7,4E-4	0,00E+00	0,00E+00	0,00E+00	5,75E-6	6,31E-5	2,01E-6	-5,69E-4
0,00E+00	8,34E-3	0,00E+00	0,00E+00	0,00E+00	6,35E-5	7,27E-4	2,2E-5	-6,85E-3
0,00E+00	2,48E-3	0,00E+00	0,00E+00	0,00E+00	2,04E-5	1,99E-4	6,23E-6	-4,84E-3
0,00E+00	1,7E-5	0,00E+00	0,00E+00	0,00E+00	7,75E-8	1,26E-6	5,77E-9	-4,25E-7
0,00E+00	1,03E+01	0,00E+00	0,00E+00	0,00E+00	7,07E-2	3,15E-1	1,52E-2	-5,82E0
0,00E+00	7,47E-2	0,00E+00	0,00E+00	0,00E+00	2,63E-4	4,98E-3	8,12E-4	-2,27E-1

* **Disclaimer:** The results of this environmental impact indicator shall be used with care as the uncertainties of these results are high or as there is limited experience with the indicator.

Production

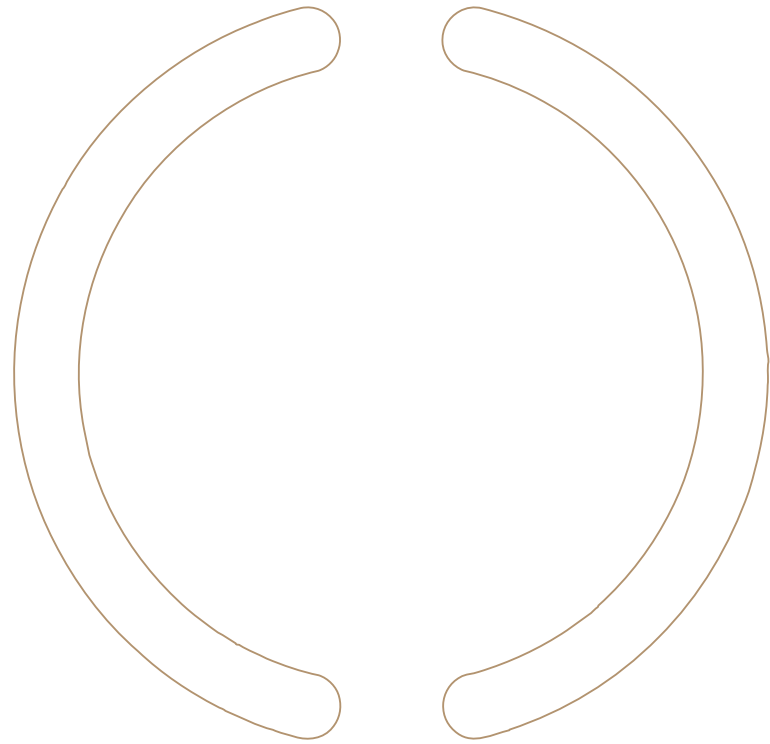

item no. 14405402123

We own our factories and are proud to control our production process, because it means we can maintain a tight focus and a productive attitude towards efficiency, quality and the endurance of our products.

04

Quality to last forever

Instead of relying on automated machines or computers, our products are made by people, meaning we can flex to meet any situation or requirement. This human aspect of our production is in everything; from the way we craft different sizes of the same product completely differently, to the handling and doublechecking of every item many times. Each piece is examined for perfection at every point along its hand production, as well as being extensively inspected at the final step of its assembly. In this way, quality control of everything we make is the responsibility of everyone involved in the making.

A LEAN production

We want our production to be swift and LEAN, because we know the value of short lead times – yet we're mindful always of achieving precision as well as speed, because we never want to make mistakes.

Being LEAN in our production is also about minimising waste and consumption, because our credentials in sustainability are incredibly important to us. Overall, our approach is one of constant tweaking in order to achieve and maintain the perfect balance between all these aspects.

ISO certified facilities

Continuous improvement is the core value of any management system. And we believe, that prevention is better than correction. That's why





we've certified both our production facilities to comply with the Environmental Management System (ISO 14001), and our d line Production CN is further ISO 9001 certified (Quality Management System).

Following each standard and committing to its demands requires commitment from leadership, to planning, performance, evaluation and right through to improvements. This gives room for evidence-based decision making and ensures that we have the environment and quality in mind across the entire organization, including employees and stakeholders. Each management system is lead through rule books, work instructions, internal standards, inspections and quality checks.

ENVIRONMENTAL PROTECTION EFFICIENCY INDICATORS - D LINE PRODUCTION UAB

Electricity consumption per 1000 pcs. products	kWh	261.84
Compressed air consumption per 1000 pcs. products	m3	44.53
Relative heat consumption per DL	MWh/DL	0.07
Main raw material losses (according to generated waste)		
- Stainless Steel	%	19.47
- Aluminum	%	5.95
- Brass	%	4.98
- Average	%	10.13
Amount of unsorted waste (from total flow)	%	0.13
Claims (complaints) about environmental protection	pcs.	0
Penalties for environmental violations	Eur	0

ENVIRONMENTAL PROTECTION EFFICIENCY INDICATORS - D LINE PRODUCTION CN

Noise in working place	db	< 60
Wastewater disposal compliance with regulation	%	100
solid waste disposal compliance with regulations	%	100
Power energy saving less than previous year	%	2
Prevent fire accidents every year	accidents	0

Our commitment to EMS is to live up to our purpose of **making highly enduring choices**, and we believe that its not a question of whether we can be sustainable, but whether we choose to be.

Whilst the Quality Management System (QMS) helps set in place procedures to ensure quality across the entire organization, the Environmental Management System (EMS) is a KPI based approach to ensure the health and safety of the world, people and atmosphere. The system inspects anything from wastewater, waste air, noise, energy, solid waste disposal and dust.

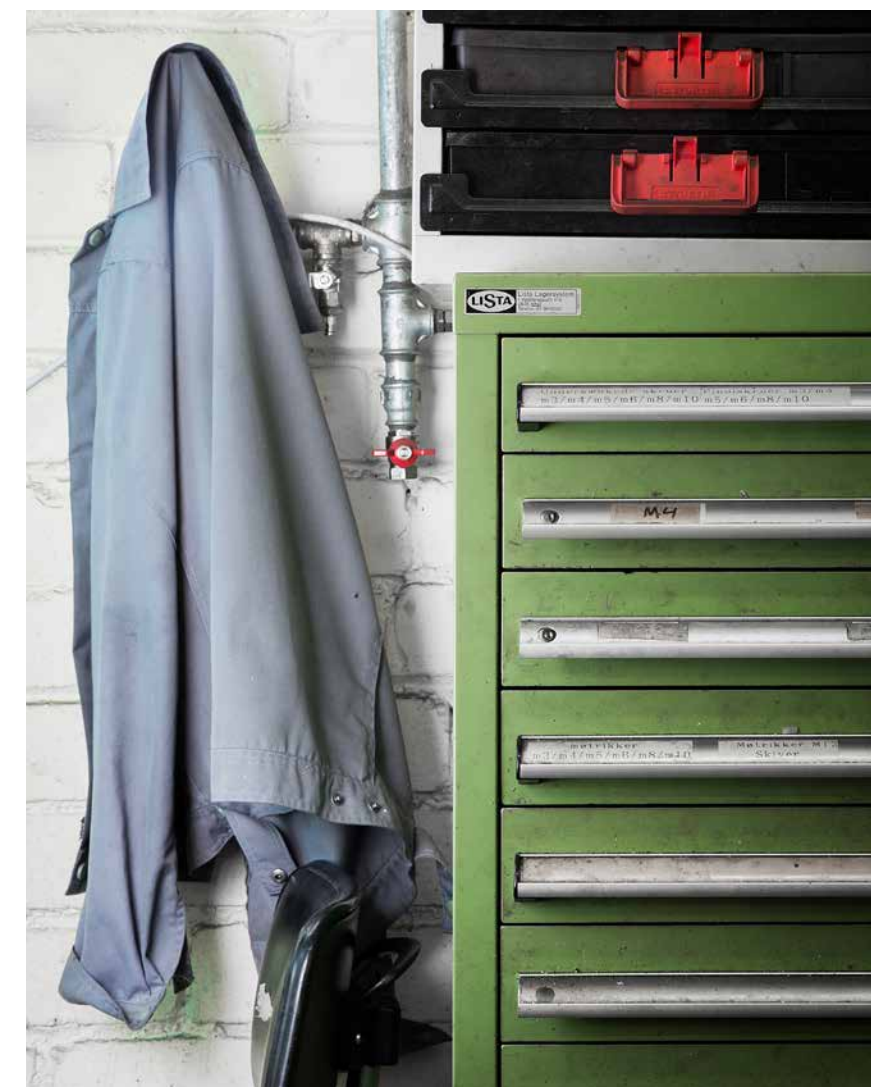

Sourcing, processing and recycling



05

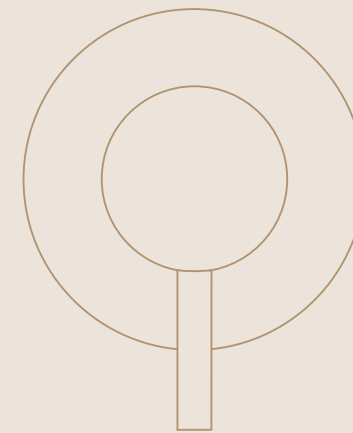

item no. QT3100-250SM

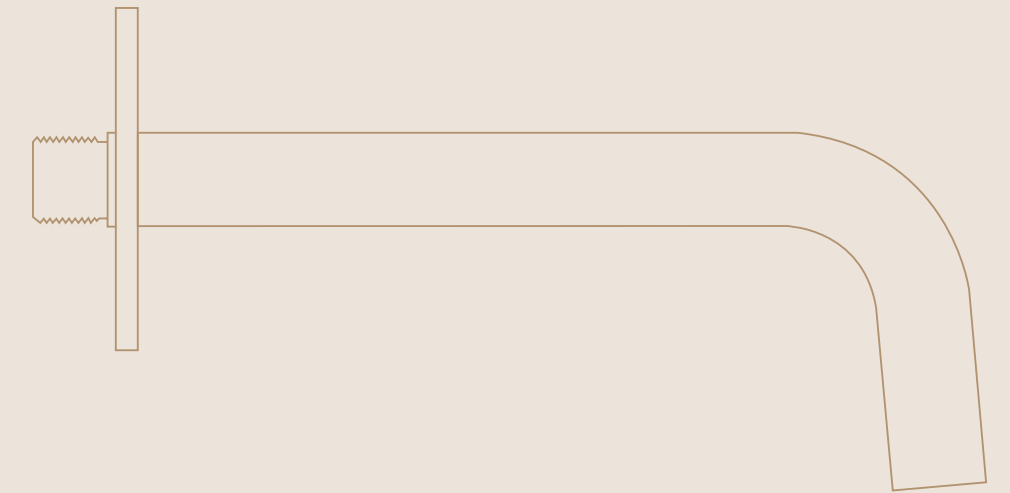

Local sourcing

How d line acquires our steel has been carefully thought through, from sourcing to processing, right through to scraps. We purchase our steel locally, because it conforms with our high-quality standards and is in close proximity to our production facility. We buy only steel for the need we have, and keep just enough in reserve to react quickly if an urgent order comes in. This is not only because we don't want to be responsible for mining and producing steel that's not needed, it's also to avoid the emissions that powering a large-scale storage facility demands.

Waste minimization goals

We don't want our production failures to account for waste, so our waste minimization goals include a keen focus on getting our production absolutely perfect each time. This focus means that these types of scraps only account for about 0.3 per cent of our entire production – and we're working to reduce even this small number all the time.

Fully recyclable raw material

When we have used the steel for the purpose we bought it for, we ensure nothing is thrown away. All our metal are (and can always be) carefully sorted and 100 per cent recycled, as a way to repurpose, reuse and avoid unnecessary waste.

Ambitions

At d line obtaining EPD's and ISO 14001 certifications is a means and not the end of a journey. We think that sustainability is a living thing, so we constantly strive to innovate across design, engineering and technology, seeing our pieces not so much as final results but as continuing evolutions.

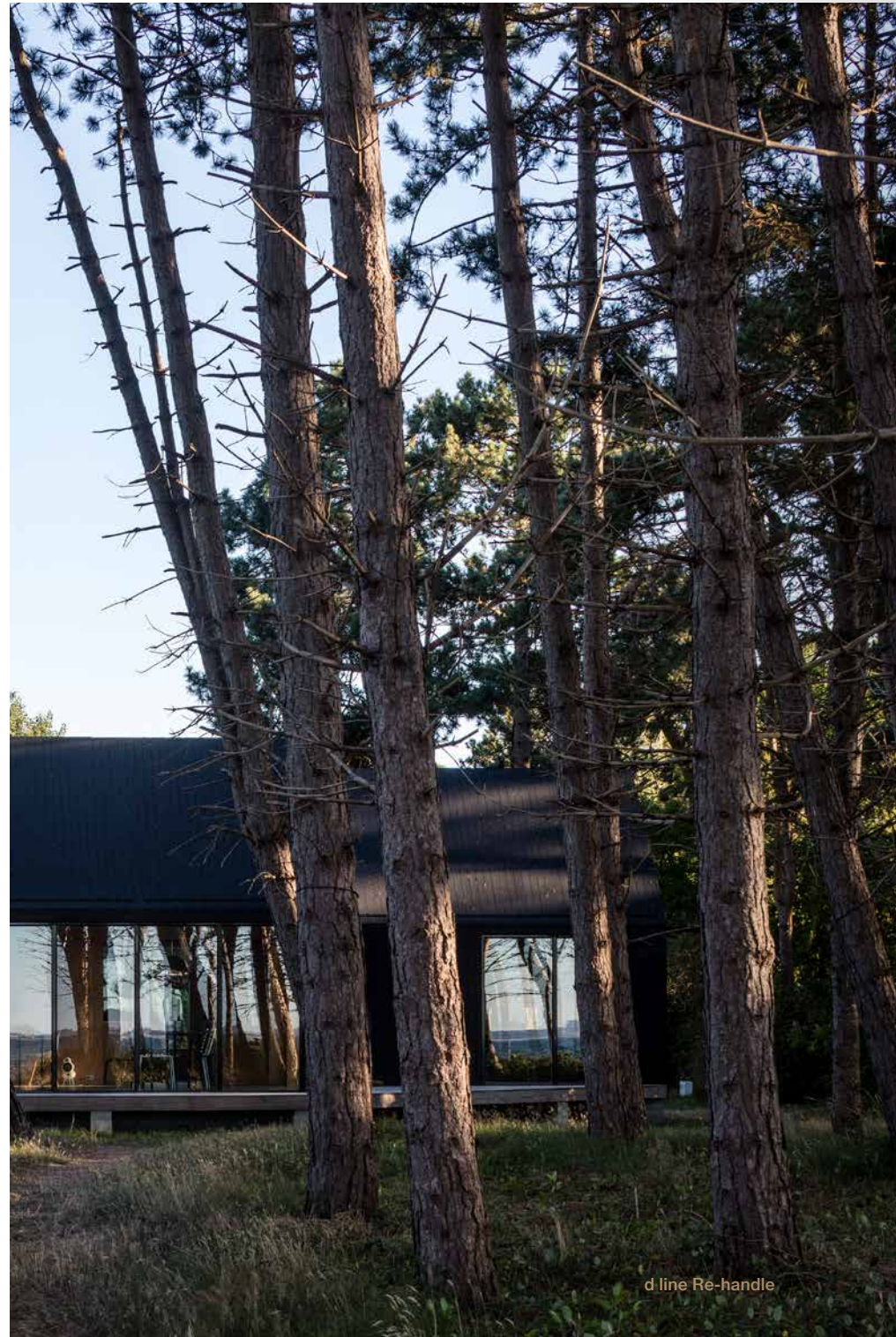

d line Re-handle

06

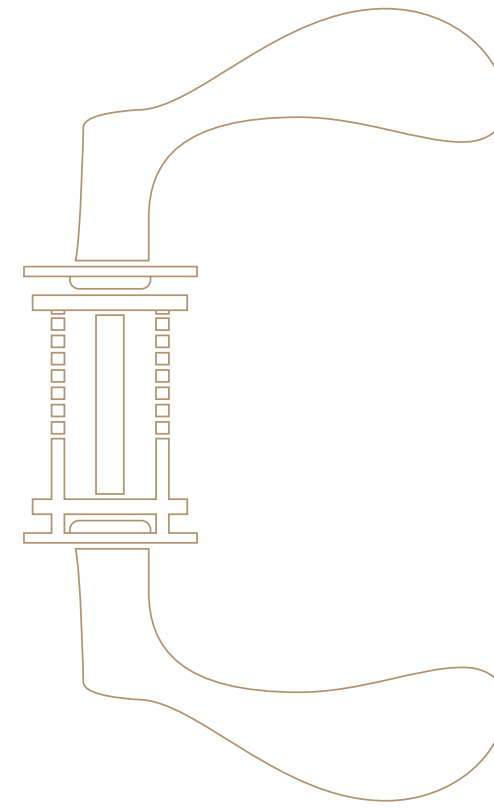

item no. 12404474030

d line Re-handle

The start of something everlasting

Our ambition until 2026 is to challenge ourselves – and you – to make the highly enduring choice:

- Innovate further within Re-handle; developing the range and possibilities.
- Use our environmental and quality declarations/certifications as drivers for further internal improvements.
- Challenge the industry to make data-driven decision making, and innovate further within environmental certifications.



Stories

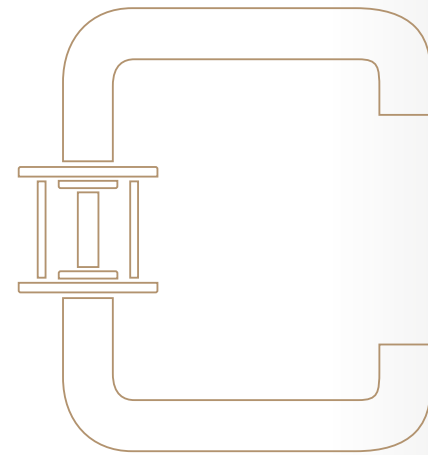

item no. 14051602017

We've put our endurance to the test

What is the difference between high standards and raising the bar? We put the craftsmanship of our products to the test and found that each of our lever handles can endure 10 million uses. With an average of 20 uses a day that makes a lifespan of 1370 years. Now we introduce d line Re-handled to prolong the life of our products. We fix and brush up on your product and renew your 20-year warranty. That's how we raise the bar.

07

100% recyclable taps and shower fixtures

Our latest addition to the d line portfolio is our Qtoo collection of taps and shower fixtures, which are manufactured (inside and out) in 100% recyclable stainless steel. We have always prioritised the use of stainless steel in our production due to its endurance and recyclability – but we do so even more, when it comes to our taps and shower fixtures due to the lower number of heavy metals it contains, compared to other unrecyclable chrome products. Furthermore, in the production of our stainless steel taps and showers no chemicals are used, nor any contaminating surface treatments.

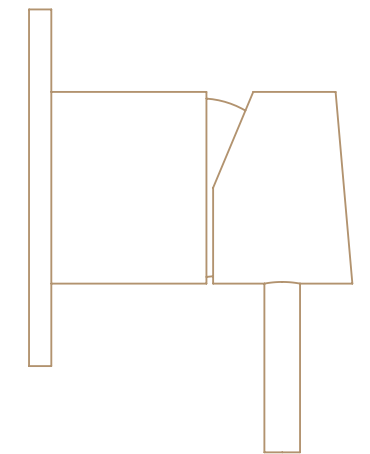

item no. QA2190M



This collab wants to disrupt Denmark's affinity for "Fast Kitchens"

In Denmark, we replace our kitchens every eleventh year. That's not only a waste of resources, but also a waste of money. In the pursuit of creating solutions that endure, we've teamed up with disruptive Kitchen designer, &Shufl, to challenge this underlying misconception that new is better. &Shufl's ethos is fundamentally based on adding simple, reliable parameters to kitchens with as little CO₂ emission as possible, to keep them in their life cycle. With just a few adjustments in cabinets or tables tops, you can change an entire room in terms of form, function and aesthetics. Now &Shufl's customers also have the possibility to return used d line cabinet handles, to be reused once again and avoid unnecessary production. This opens a completely new potential, as the handles can live in up to several kitchens during their 20-year warranty period alone.

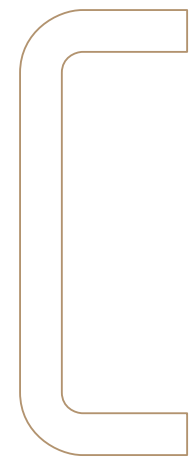

item no. 14391202128



Case study: Re-handling at SU styrelsen

When the old office of SU Styrelsen (Public Administration for The Danish students' Grants and Loans Scheme) were to be repurposed as student accommodation, it was done with great deftness to the reusing and upcycling of the original elements.

Having seen that the original Knud Holscher lever handles were still as enduring as when first specified, it was natural that these should continue into the new abodes as a way to repurpose, reuse and avoid unnecessary waste. The Locksmith therefore carefully dismantled and

stored the existing lever handles during construction work, and refitted all lever handles with new screws and PVC bushes, so that they could continue to live in the spaces they occupy, forever.

Project by Arkitema Architects.

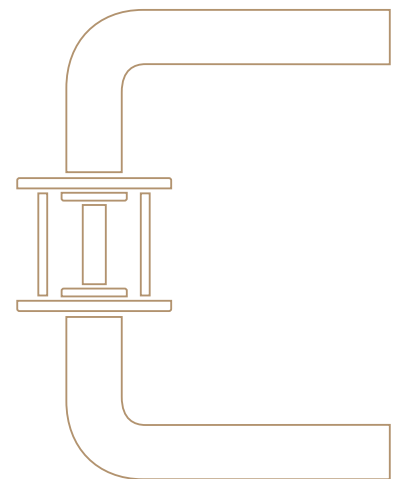

item no. 14041602011



d line A/S

Jyllingevej 59, kld
2720 København

Tlf.: +45 72 17 01 38
Email: support@dline.com

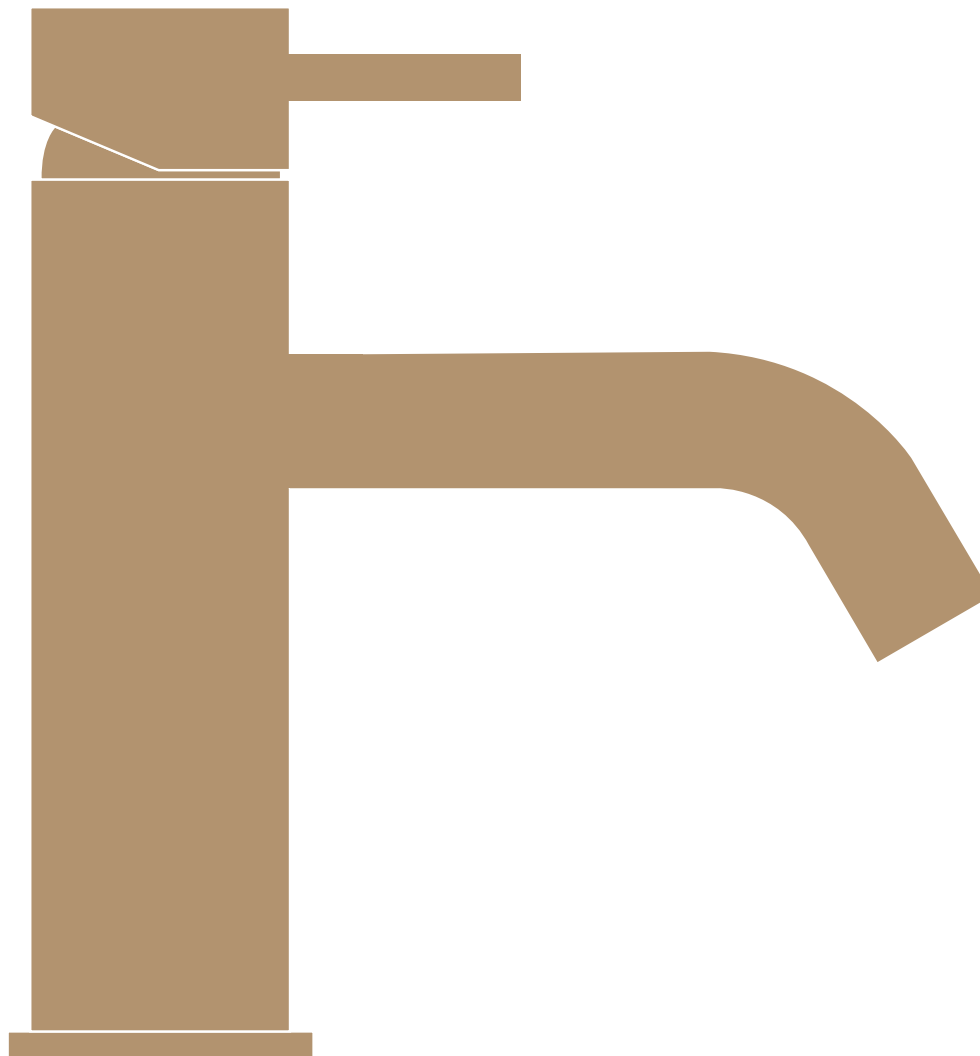

Re-handle[®]

d line