



www.hy-lok.com

Catalog No. H-200TF-SD
Apr. 2013

UNS S32750 Super Duplex Hy-Lok[®] Tube Fittings

sizes from 1/4" thru 1" (6mm thru 25mm)



- Excellent corrosion resistance in chloride-bearing environments
- NORSOK M-650 qualified for forged products



HY-LOK CORPORATION

©2013 HY-LOK CORPORATION All rights reserved

FLOWTEKNIK
SCANDINAVIA APS



UNS S32750 Super Duplex Stainless Steel Tube Fittings

Introduction

Hy-Lok UNS S32750 Super Duplex Stainless Steel Tube Fittings provide a high mechanical strength and outstanding corrosion resistance characteristics.

This fitting provides the secure and leak-free connections in a wide range of corrosive environments, including offshore oil and gas industry, and instrumentation systems requiring high operating pressures:

- This fitting offers gaugeability, leak-tight installation and performance enough to seal and vibration resistant grip at working pressures associated with extremely hard SAF 2507™ tubing.
- This fitting can be assembled quickly, easily and reliably with standard hand tools. Each size can be preset with preswaging tool and hydraulic preswaging unit.

Material Specification & Identification

The body, nut, and front ferrule is made of UNS S32750 stainless steel, while the back ferrule is made of 6MO material (UNS S31254 · 254 SMO™).

UNS S32750 and UNS S31254 materials used in the Hy-Lok fitting components have a minimum pitting resistance equivalent (PRE) value of 42.5. This PRE value contributes to the strength and corrosion resistance.

Forged products can be supplied according to the NORSOK M-650 Standard.

The fitting components are stamped with its material.

The nut has a V-shaped notch on the hex to identify its material type.



Component	Materials
Body	ASTM A 479 UNS S32750 ASTM A 182 UNS S32750
Front Ferrule	ASTM A 479 UNS S32750
Back Ferrule	ASTM A 479 UNS S31254
Nut	ASTM A 479 UNS S32750

SAF 2507™ is a trademark of Sandvik AB

254 SMO™ is a trademark of Avesta AB

Maximum Allowable Working Pressure Tables

Allowable working pressures are calculated from an S value of 38,700 psi (266.8 MPa) for ASTM A789 tubing at -20 to 100°F (-28 to 37°C), as listed in ASME B31.3.

Fully annealed UNS 32750 super duplex stainless steel tubing meets ASTM A789 or equivalent. Hardness not to exceed HRC 32.

For gas service, use tube wall thicknesses outside the shaded area.

Careful selection of high-quality tubing is important for the installation of safe, leak-tight systems.

Tube O.D. (Inches)	Tube Wall Thickness (Inches) : Working Pressure (psig)					
	0.035	0.049	0.065	0.083	0.095	0.109
1/4"	10,000	14,500				
3/8"	6,500	9,300	12,700			
1/2"	5,000	7,200	9,900	13,000		
5/8"		5,800	7,700	10,100		
3/4"		4,700	6,400	8,300	9,600	
7/8"		4,000	5,400	7,000	8,100	9,500
1"			4,700	6,100	7,000	8,200

Tube O.D. (mm)	Tube Wall Thickness (mm) : Working Pressure (bar)								
	0.8	1.0	1.2	1.5	1.8	2.0	2.2	2.5	3.0
6	650	830	1,000	1,300					
10		480	580	750					
12		400	480	610	750	840			
16			380	480	580	650	720	840	
20			300	380	460	510	570	650	
22			270	340	410	460	510	590	720
25					360	400	450	510	630

Temperature Rating

-50 to 482°F (-46 to 250°C)

Temperature Derating

Multiply working pressure from the table above by the appropriate factor to obtain working pressure at elevated temperatures.

Use of UNS 32750 super duplex stainless steel at temperatures above 482°F (250°C) causes microstructural changes that lead to embrittlement and loss of corrosion resistance.

Example: To obtain the working pressure of 1/2" O.D. X 0.049" Wall tubing at 300°F (148°C)

- Working pressure at 100°F (37°C) : 7,200 psig (495 bar)
- Temperature derating factor at 300°F (148°C) : 0.85
- Working pressure at 300°F (148°C) : 6,100 psig (420 bar)

Temperature °F(°C)	Factor
200 (93)	0.90
300 (149)	0.85
400 (204)	0.82
482 (250)	0.81

Straight Union CUA



Part No.	Tube O.D. (inch)	Part No.	Tube O.D. (mm)
CUA - 4	1/4	CUA - 6M	6
CUA - 6	3/8	CUA - 10M	10
CUA - 8	1/2	CUA - 12M	12
CUA - 10	5/8	CUA - 16M	16
CUA - 12	3/4	CUA - 20M	20
CUA - 14	7/8	CUA - 22M	22
CUA - 16	1	CUA - 25M	25

Union Elbow CLA



Part No.	Tube O.D. (inch)	Part No.	Tube O.D. (mm)
CLA - 4	1/4	CLA - 6M	6
CLA - 6	3/8	CLA - 10M	10
CLA - 8	1/2	CLA - 12M	12
CLA - 10	5/8	CLA - 16M	16
CLA - 12	3/4	CLA - 20M	20
CLA - 14	7/8	CLA - 22M	22
CLA - 16	1	CLA - 25M	25

Union Tee CTA



Part No.	Tube O.D. (inch)	Part No.	Tube O.D. (mm)
CTA - 4	1/4	CTA - 6M	6
CTA - 6	3/8	CTA - 10M	10
CTA - 8	1/2	CTA - 12M	12
CTA - 10	5/8	CTA - 16M	16
CTA - 12	3/4	CTA - 20M	20
CTA - 14	7/8	CTA - 22M	22
CTA - 16	1	CTA - 25M	25

Union Cross CXA



Part No.	Tube O.D. (inch)	Part No.	Tube O.D. (mm)
CXA - 4	1/4	CXA - 6M	6
CXA - 6	3/8	CXA - 10M	10
CXA - 8	1/2	CXA - 12M	12
CXA - 10	5/8	CXA - 16M	16
CXA - 12	3/4	CXA - 20M	20
CXA - 14	7/8	CXA - 22M	22
CXA - 16	1	CXA - 25M	25

All dimensions are same as Hy-Lok tube fittings standard.

UNS S32750 Super Duplex Stainless Steel Tube Fittings

Bulkhead Union CBU

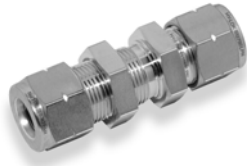

Part No.	Tube O.D. (inch)	Part No.	Tube O.D. (mm)
CBU - 4	1/4	CBU - 6M	6
CBU - 6	3/8	CBU - 10M	10
CBU - 8	1/2	CBU - 12M	12
CBU - 10	5/8	CBU - 16M	16
CBU - 12	3/4	CBU - 20M	20
CBU - 14	7/8	CBU - 22M	22
CBU - 16	1	CBU - 25M	25

Male Connector CMC



Part No.	Tube O.D. (inch)	NPT Size (inch)
CMC 4 - 4N	1/4	1/4
CMC 4 - 8N	1/4	1/2
CMC 6 - 4N	3/8	1/4
CMC 6 - 6N	3/8	3/8
CMC 6 - 8N	3/8	1/2
CMC 8 - 4N	1/2	1/4
CMC 8 - 6N	1/2	3/8
CMC 8 - 8N	1/2	1/2
CMC12 - 12N	3/4	3/4
CMC16 - 16N	1	1

SAE/MS Male Connector CSC



Part No.	Tube O.D (inch)	Straight Thread(U)
CSC 4 - 4U	1/4	7/16 - 20
CSC 4 - 6U	1/4	9/16 - 18
CSC 6 - 6U	3/8	9/16 - 18
CSC 8 - 6U	1/2	9/16 - 18
CSC 8 - 8U	1/2	3/4 - 16
CSC 10 - 10U	5/8	7/8 - 14
CSC 12 - 12U	3/4	1 1/16 - 12
CSC 14 - 14U	7/8	1 3/16 - 12
CSC 16 - 16U	1	1 5/16 - 12

Male Adapter CAM



Part No.	Tube O.D. (inch)	NPT Size (inch)
CAM 4 - 4N	1/4	1/4
CAM 4 - 8N	1/4	1/2
CAM 6 - 4N	3/8	1/4
CAM 6 - 6N	3/8	3/8
CAM 6 - 8N	3/8	1/2
CAM 8 - 4N	1/2	1/4
CAM 8 - 6N	1/2	3/8
CAM 8 - 8N	1/2	1/2
CAM 12 - 12N	3/4	3/4
CAM 16 - 16N	1	1

All dimensions are same as Hy-Lok tube fittings standard.

SAE/MS Male Adapter **CAM-U**



Part No.	Tube O.D. (inch)	Straight Thread(U)
CAM 4 - 4U	1/4	7/16 - 20
CAM 4 - 6U	1/4	9/16 - 18
CAM 6 - 6U	3/8	9/16 - 18
CAM 8 - 6U	1/2	9/16 - 18
CAM 8 - 8U	1/2	3/4 - 16
CAM 10 - 10U	5/8	7/8 - 14
CAM 12 - 12U	3/4	1 1/16 - 12
CAM 16 - 16U	1	1 5/16 - 12

Port Connector **CPC**



Part No.	Tube O.D. (inch)	Part No.	Tube O.D. (mm)
CPC - 4	1/4	CPC - 6M	6
CPC - 6	3/8	CPC - 10M	10
CPC - 8	1/2	CPC - 12M	12
CPC - 10	5/8	CPC - 16M	16
CPC - 12	3/4	CPC - 20M	20
CPC - 14	7/8	CPC - 22M	22
CPC - 16	1	CPC - 25M	25

Plug **CPA**



Part No.	Tube O.D. (inch)	Part No.	Tube O.D. (mm)
CPA - 4	1/4	CPA - 6M	6
CPA - 6	3/8	CPA - 10M	10
CPA - 8	1/2	CPA - 12M	12
CPA - 10	5/8	CPA - 16M	16
CPA - 12	3/4	CPA - 20M	20
CPA - 14	7/8	CPA - 22M	22
CPA - 16	1	CPA - 25M	25

Cap **CCA**



Part No.	Tube O.D. (inch)	Part No.	Tube O.D. (mm)
CCA - 4	1/4	CCA - 6M	6
CCA - 6	3/8	CCA - 10M	10
CCA - 8	1/2	CCA - 12M	12
CCA - 10	5/8	CCA - 16M	16
CCA - 12	3/4	CCA - 20M	20
CCA - 14	7/8	CCA - 22M	22
CCA - 16	1	CCA - 25M	25

All dimensions are same as Hy-Lok tube fittings standard.

UNS S32750 Super Duplex Stainless Steel Tube Fittings

Cone-and-Thread Adapter CCTAM

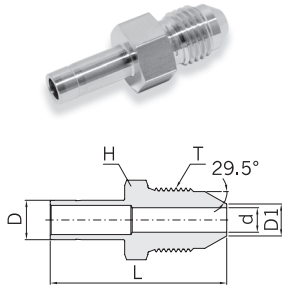

Part No.	Tube O.D D		Medium Pressure Tube Size		Straight Thread T	d min.	Width across flat h		D ₁	L
	in	mm	in	mm			in	mm		
CCTAM 4 - 4	1/4	6.35	1/4	6.35	7/16-20UNF-2	2.79	1/2	12.70	3.56	39.62
CCTAM 6 - 6	3/8	9.52	3/8	9.52	9/16-18UNF-2	5.33	5/8	15.87	6.35	47.24
CCTAM 8 - 9	1/2	12.70	9/16	14.28	13/16-16UN-2	7.87	7/8	22.22	10.41	56.90
CCTAM 10 - 9	5/8	15.87	9/16	14.28	13/16-16UN-2	7.87	7/8	22.22	10.41	60.96
CCTAM 12 - 12	3/4	19.05	3/4	19.05	3/4-14NPSM	11.43	1-1/8	28.57	14.22	68.07

Cone-and-Thread Female Adapter CCTAF

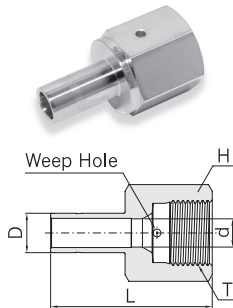

Part No.	Tube O.D D		Medium Pressure Tube Size		Straight Thread T	d min.	Width across flat h		L
	in	mm	in	mm			in	mm	
CCTAF 4 - 4	1/4	6.35	1/4	6.35	7/16-20UNF-2	2.79	11/16	17.46	33.27
CCTAF 6 - 6	3/8	9.52	3/8	9.52	9/16-18UNF-2	5.08	7/8	22.22	38.35
CCTAF 8 - 9	1/2	12.7	9/16	14.28	13/16-16UN-2	9.14	1-1/16	26.98	52.07

Cone-and-Thread Connector CCTMC

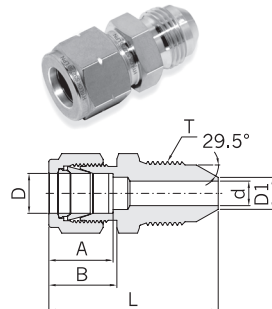

Part No.	Tube O.D D		Medium Pressure Tube Size		Straight Thread T	d min.	Width across flat h		A	B	D ₁	L
	in	mm	in	mm			in	mm				
CCTMC 4 - 4	1/4	6.35	1/4	6.35	7/16-20UNF-2	2.79	1/2	12.70	15.24	17.78	3.56	41.15
CCTMC 6 - 6	3/8	9.52	3/8	9.52	9/16-18UNF-2	5.33	5/8	15.87	16.76	19.30	6.35	48.77
CCTMC 8 - 9	1/2	12.7	9/16	14.28	13/16-16UN-2	7.87	7/8	22.22	22.86	21.84	10.41	54.61
CCTMC 10 - 9	5/8	15.87	9/16	14.28	13/16-16UN-2	7.87	1-1/16	26.98	24.38	21.84	10.41	56.90
CCTMC 12 - 12	3/4	19.05	3/4	19.05	3/4-14NPSM	11.43	1-3/16	30.16	24.38	21.84	14.22	64.26

Cone-and-Thread Female Connector CCTFC

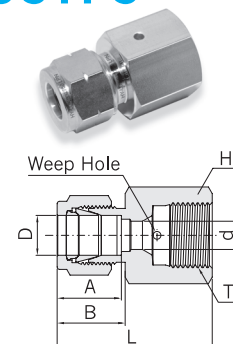

Part No.	Tube O.D D		Medium Pressure Tube Size		Straight Thread T	d min.	Width across flat h		A	B	L
	in	mm	in	mm			in	mm			
CCTFC 4 - 4	1/4	6.35	1/4	6.35	7/16-20UNF-2	2.79	11/16	17.46	15.24	17.78	34.80
CCTFC 6 - 6	3/8	9.52	3/8	9.52	9/16-18UNF-2	5.08	7/8	22.22	16.76	19.30	39.88
CCTFC 8 - 9	1/2	12.7	9/16	14.28	13/16-16UN-2	9.14	1-1/16	26.98	22.86	21.84	49.78

Installation Instructions

Tube Preparation

1. Check if the tubing O.D., wall thickness, ovality, hardness and their tolerances are within specification for your application.
Also check if surface is free from scratches and dirt.
2. Make a square cut. (Always use proper tube cutter. Improper tube cutter can cause excessive tube deformation at the tube end.)
3. Remove burrs from inner and outer edges of the tubing.

Installation Instructions

Hy-Lok Two Ferrule Tube Fittings are supplied fully assembled, finger tight and are readily usable. A leak tight and mechanically safe installation is easily made by turning the nut 1 1/4 turns.

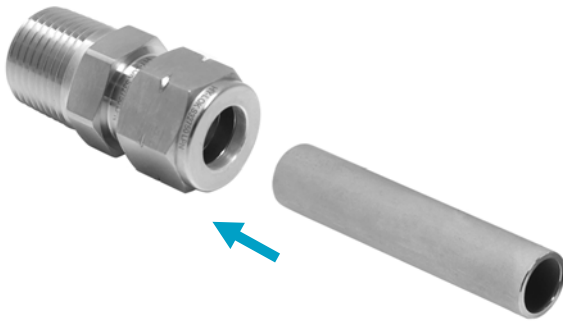

1. Insert prepared tubing into Hy-Lok tube fittings until tubing end is firmly seated the shoulder of the fitting body and make sure that the nut is finger-tight.

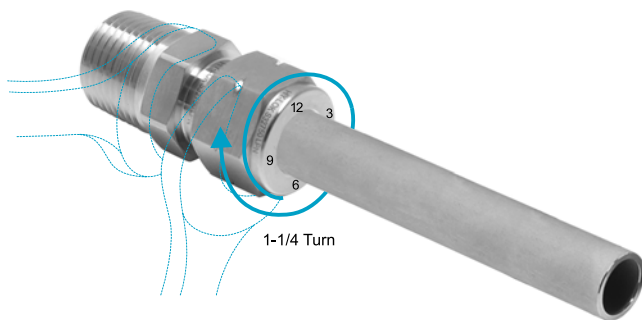

2. Mark the nut at 6 o'clock position for identification of starting point.
3. Tighten the nut 1 1/4 turns with a wrench holding the fitting body steady with a back-up wrench. When the nut is tightened 1 1/4 turns, the mark at 6 o'clock position before tightening will be now at 9 o'clock position.

Gap Inspection Gauges

Gap inspection gauges assure the installer that the fitting has been sufficiently tightened on initial installation.

1. Check gap between nut and body hex, using the proper size gauge.
2. If the gauge DOES NOT FIT AT ANY POINT between nut and body hex, you have correctly tightened the nut.
3. If the gauge slides easily into the gap, the fitting is not properly pulled up, and tighten the nut further until gauge cannot enter the gap.

Note : Gap gauge should not be used for fitting which is assembled with preswaging tool.

Reassembly Instructions

Hy-Lok tube fittings can be disassembled and reassembled many times and leak tight performance can be obtained each time.

1. Insert tubing which is pre-swaged with ferrules into the fitting body.
2. Finger-tighten the nut and rotate the nut with a wrench to the original position holding the body steady with a back-up wrench, When a sharp rise in resistance will be felt at the original position, snug slightly with a wrench.

Note : Do not use the gap inspection gauge with reassembled fittings.

Preswaging Tool • Hydraulic Swaging Units

Reduces assembly time and installation error.

A wide variety of configurations is available for fractional or metric tube fittings as shown in Hy-Lok Catalog. For additional information, see the Hy-Lok Two Ferrule Tube Fittings Catalog, H-200TF.



Distributed by :



RUGVÆNGET 1 90
2600 TAASTRUP
INFO@PBFLOWTEKNIK.DK
WWW.PBFLOWTEKNIK.DK

FLOWTEKNIK
SCANDINAVIA APS