

Special-Sensors for Automation



Capacitive Sensors

Contents

Terminology for capacitive measurements	4.03 - 4.05
--	-------------

Capacitive switches and sensors

Standard switches plastic M12 Series KGK.....	4.07
Standard switches metal M18 Series KGM.....	4.08
Standard switches plastic M18 Series KGK.....	4.09
Standard switches metal M30 Series KGM.....	4.10 - 4.11
Standard switches plastic M30 Series KGK.....	4.12
Smooth-bodied switches Ø 20 mm und Ø 34 mm plastics Series KNK.....	4.13 - 4.15
Long sensing range Series KD / KNK.....	4.16 - 4.17
Special switches PTFE-thread M30 Series KGFW.....	4.18 - 4.19
Special switches PTFE-housing Ø 35 mm Series KNFW.....	4.20
200 °C-High temperature Series KGMT.....	4.21
Analog sensors Series KGA / KDA.....	4.22
Amplifiers for High temperature switches Series KK / KU.....	4.23

Capacitive sensors for Ex-applications

Dust Ex-Sensors Series KGEX / KDEX.....	4.24 - 4.26
Ex-amplifiers Series EGE 903-Ex	4.27

Accessories

M12 connector	4.28
Fixing agent.....	4.29
Cable.....	4.30

We reserve the right to make technical alterations without prior notice.

Terminology for capacitive measurement

Operating Principal

A capacitive proximity switch works with a high frequency oscillating circuit that creates an electromagnetic field on the active sensor surface by means of a capacitor. When a substantial or fluid substance nears this field a capacitance unbalance occurs and leads to a variation of the amplification in the oscillating circuit. If this amplification exceeds a threshold value, a switching signal is generated.

Operating Distance

The operating distance is the separation of an object from the active sensor surface at which a switching signal is produced. The operating distance depends on the diameter of the sensor surface. Therefore larger sensors are required for longer operating distances. Many EGE sensors have an adjustable operating distance.

Capacitive proximity switches react to conductive materials and non-conductive materials with a dielectrical constant $\epsilon > 1$. The operating distance depends on the material. Constant measurement of different materials against earthed steel ST 37 yields a changed operating distance. The following table lists the approximate values for the material dependent reduction factors. In practical applications there could be variations, because of the mounting conditions, for example.

Material	ϵ	Operating distance in % (approx.)
Steel ST 37	Conductive	100
Saltwater	80	100
Marble	8	65
Porcelain	4-5	50
PE	2.3	10
Oil	2.2	10
Wood	2-7	10-60

The water content of an object or a liquid has a decisive influence on the operating distance. A high humidity content increases the operating distance considerably.

If the proximity switch is moistened with conductive materials, its function can be impaired when a conductive film builds up that electrically connects the sensor electrode with a metallic conducting side. Capacitive proximity switches can detect filling products right through non-electrically conducting container sides. The filler will certainly be detected if its dielectric constant is at least as large as that of the container sides.

Rated operating distance s_n

The rated operating distance is a device parameter that does not take into account sample variances and external influences such as temperature and supply voltages.

Effective operating distance s_r

The effective operating distance is the operating distance at nominal voltage and at nominal temperature of 23 °C. It is between 90% and 110% of the nominal switching distance.

Usable operating distance s_u

The usable operating distance is in the entire allowable temperature and voltage range is between 80% and 120% of the real operating distance.

Assured operating distance s_a

The assured operating distance takes into account all the external influences and sample variances and is in the range from 0% to 72% of the service usable distance. Within this range a guaranteed switching is ensured.

Switch point drift

The operating distances are given for an ambient temperature of 23 °C. In the permissible temperature range the operating distance varies by less than 15 % from the value at 23 °C. The temperature of the measured object has no influence on the switch point.

Hysteresis H

The switching hysteresis describes the distance between the turn on point while approaching an object and the turn off point during the separation of it from the sensor. The hysteresis brings about a stable switching signal even when there are vibrations, temperature drift, or electrical failures. The hysteresis is defined according to EN 60947-5-2 to be a maximum 20% from the real operating distance, and carries a value of typically 10% from the real operating distance s_r for EGE sensors.

Repeating accuracy R

The repeating accuracy describes the maintenance of the switching point after the repeated approach of an object under specified circumstances. EGE sensors have typical tolerances of less than 3% of the real operating distance.

Switching frequency

The maximum switching frequency of the sensor is determined at half nominal operating distance s_n with standard measurement plates ST 37 according to EN 60947-5-2.

Colour code: BK = black BN = brown BU = blue GN = green YE = yellow GY = grey PK = pink WH = white

Terminology for capacitive measurement

Supply voltage

The operating voltage is the voltage range in which EGE sensors function safely. For a constant voltage supply it is important to make sure that the limits are still observed when the residual ripple is included.

Switching current

This current gives the maximum long-term current for the switching output of the sensor at an ambient temperature of 25 °C and ohmic load. At an elevated ambient temperature, the current load capability decreases.

For analog outputs, the boundary values given in the appropriate technical data, and particularly the permissible values for resistance loads, must be observed.

Short circuit protection

The short circuit proof ensures the sensor against destruction through a short circuit on the output. After removal of the fault, the output is reactivated. Where a maximum overload current is listed, this should not be exceeded.

Overcurrent release

This value indicates the median value of current at which the short circuit protection responds with a tolerance of $\pm 20\%$.

Reverse polarity protection

The reverse polarity protection prevents destruction of the sensor by a reversal of the polarity of the voltage supply.

Voltage drop U_d

The voltage drop arises at the internal resistance of semiconductor elements, which are in the current-path of the output. It is dependent of the load-current and is declared according to EN 60947-5-2 for a mean current of 50 mA.

Residual current I_r

The residual current flows in the load current circuit when the output is blocked. The residual current must be considered when switching sensors in parallel.

Minimum load current I_m

The minimum load current is necessary for flawless operation with two-wire devices.

Current consumption

The current consumption is the maximum value of the no-load current I_0 that the sensor can absorb without a load.

Ambient temperature

The ambient temperature indicates the maximum allowable temperature range for the sensor.

Electromagnetic compatibility EMC

The EMC class is a measure of the noise immunity of the sensor against external electrical and magnetic influences. The information is based on the standard EN 61000-6-2.

Switch-on impulse suppression

EGE sensors have a switch-on impulse suppression that blocks the output during the switch-on phase, when the operational voltage is applied.

Protection

The protective system indicates the protection of the sensors against penetration of foreign bodies and water according to EN 60529.

LED-Display

EGE sensors with yellow light-emitting diodes indicate the switching status optically.

Housing material

The housing material determines the chemical resistance of the sensor against external influences. For special applications, other housing materials are available.

Connection

The connection of the sensors is accomplished through plug-in connections or cables. Different cable types and lengths are available upon request.

Instructions for mounting

Mounting

For flush mounting the sensor can be built into metal up to its active surface without changing its characteristics. For non-flush mounting a metal-free zone around the sensor must be allowed for. A free zone to the material opposite the sensor must be maintained for all sensors.

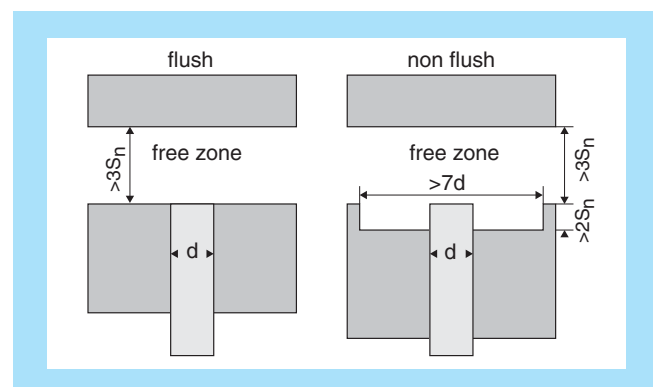

The indicated free zones are in accordance with the standard EN 60947-5-2.

For mounting clamps see page 4.29.

Terminology for capacitive measurement

Collocation

When collocating the sensors, a minimum separation must be kept between the devices in order to avoid mutual influence. When in doubt, a test should be conducted under application conditions. For flush mounting the lateral separation between two sensors must correspond to at least the diameter of the sensor. For non flush mounting, the lateral separation from each other must correspond to at least twice the diameter of the sensor. For separations greater than eight times the diameter no mutual influence is to be expected. For oppositely mounted sensors, a minimal separation of eight times the nominal switching distance should be allowed.

Torques

In order to prevent destruction of the threaded bushing during fitting, the following maximum torques must not be exceeded:

Design	Metal Housing	Plastic Housing
M12x1	10 Nm	1 Nm
M18x1	25 Nm	2 Nm
M30x1.5	40 Nm	5 Nm

PTFE sensors may only be tightened by hand.

Instructions for operation

Serial connection

For the serial connection of two wire or three wire sensors the individual voltage drops are added together. Therefore there is a lesser operational voltage at the disposal of the load. The addition of the switch-on delay times should be noted.

Parallel connection

The parallel connection of two wire sensors can only be conditionally recommended since the residual currents are added together and flow through the load. For the parallel connection of three wire sensors, the current consumption of the individual devices is added together. Since this current does not flow through the load, the maximum number of parallel connectable three wire sensors depends only on the power supply.

Approval for safety applications

Sensors for personal security must have a qualification approval according to EN 954-1 and must be labeled accordingly. Sensors that are not labeled must not be used for applications of this kind.

Valid standards:

- EN 60947-5-2
Control units; low voltage control units, auxiliary switch, proximity switch
- EN 61000-6-4
Electromagnetic compatibility (EMC)
Interference emissions in the industrial area
- EN 61000-6-2
Electromagnetic compatibility (EMC)
Generic standards immunity for industrial environments
- EN 61000-4-2 (ESD)
Electrostatic discharging immunity
- EN 61000-4-3 (HF radiated)
Radiated radio-frequency electromagnetic field immunity test
- EN 61000-4-4 (Burst)
Electrical fast transient / burst immunity test
- EN 60529
Protective systems, IP-designation
- EN 60079-0 : 2012
Explosive atmospheres –
Part 0: Equipment – General requirements
- EN 60079-11 : 2012
Explosive atmospheres –
Part 11: Equipment protection by intrinsic safety "i"
- EN 60079-18 : 2009
Explosive atmospheres –
Part 18: Equipment protection by encapsulation "m"

Authorisations

TÜV NORD CERT Zertifizierungsstelle - Deutschland
(technical monitoring certification agency - Germany)

Certification



- TÜV NORD CERT ISO 9001
- TÜV NORD CERT Quality control production
Attachment IV of the EC-Guidelines
94/9/EG
- TÜV Nord Re-cancelling certificate according to
EN 10204

Standard switches

Series KGK
Plastic-thread
M12x1

DC 10...33 V

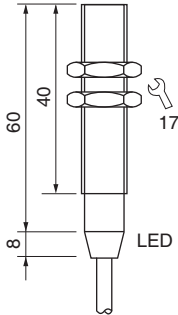
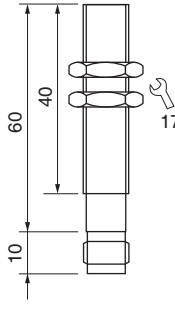

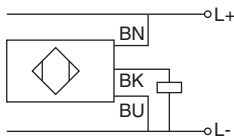
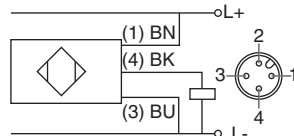



Design	DC PNP • M12x1	DC PNP • M12x1
Dimensions		
Installation flush (f) non flush (nf)	LED	
Operating distance sn [mm]	2 nf	2 nf
Switching output		
ID-No.	P41300	P41303
Type	KGK 002 GSP	KGKU 002 GSP
Supply voltage [V]	10...33 DC	10...33 DC
Switching current [mA]	400	400
Short circuit proof	•	•
Overcurrent release [mA]	800	800
Reverse protection	•	•
Voltage drop max. [V]	1.5	1.5
Residual current [mA]	0.2	0.2
Current consumption (not actuated) [mA]	4	4
Switching frequency [Hz]	25	25
Ambient temperature [°C]	-25...+70	-25...+70
EMC-class	A	A
Protection [EN 60529]	IP 67	IP 67
LED display	•	•
Housing material	PPO	PPO
Connection	2 m PVC-cable 3x0.34 mm ²	M12 connector
Connection diagram		
Accessories (see page 4.28)	Fixing nuts are part of delivery	

Standard switches

Series KGM
Metal-thread
M18x1

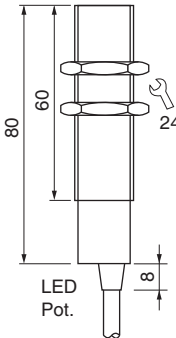
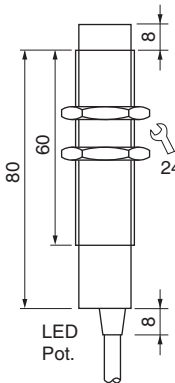
DC 10...55 V



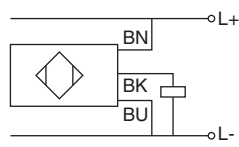
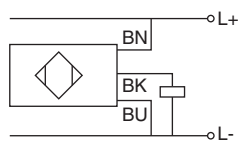

Design	DC PNP • M18x1		DC PNP • M18x1	
Dimensions				
Installation flush (f) non flush (nb)				
Operating distance sn [mm] (Adjustable range)	5 f (1...7)	5 f (1...7)	8 nf (1...10)	8 nf (1...10)
Switching output				
ID-No.	P41001	P41002	P41009	P41010
Type	KGM 005 GSP	KGM 005 GOP	KGM 007 GSP	KGM 007 GOP
Supply voltage [V]	10...55 DC	10...55 DC	10...55 DC	10...55 DC
Switching current [mA]	400	400	400	400
Short circuit proof	•	•	•	•
Overcurrent release [mA]	800	800	800	800
Reverse protection	•	•	•	•
Voltage drop max. [V]	1.5	1.5	1.5	1.5
Residual current [mA]	0.2	0.2	0.2	0.2
Current consumption (not actuated) [mA]	4	12	4	12
Switching frequency [Hz]	25	25	25	25
Ambient temperature [°C]	-25...+70	-25...+70	-25...+70	-25...+70
EMC-class	A	A	A	A
Protection [EN 60529]	IP 67	IP 67	IP 67	IP 67
LED display	•	•	•	•
Housing material	Br-Ni / PPO	Br-Ni / PPO	Br-Ni / PPO	Br-Ni / PPO
Connection	2 m PVC-cable 3x0.5 mm ²	2 m PVC-cable 3x0.5 mm ²	2 m PVC-cable 3x0.5 mm ²	2 m PVC-cable 3x0.5 mm ²
Connection diagram				
Accessories (see page 4.29)	fixing nuts are part of delivery			

Standard switches

Series KGK
Plastic-thread
M18x1

DC 10...55 V

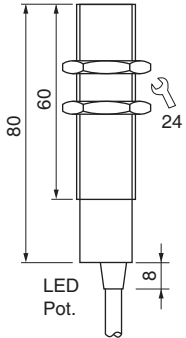
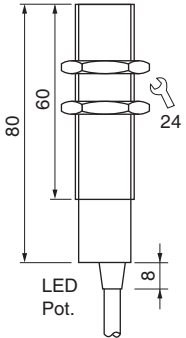

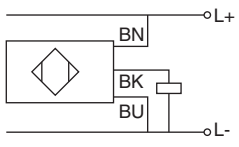
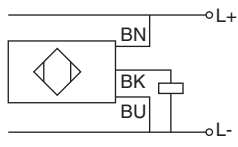



Design	DC PNP • M18x1	DC PNP • M18x1
Dimensions		
Installation flush (f) non flush (nf)	LED Pot.	LED Pot.
Operating distance sn [mm] (Adjustable range)	8 nf (1...10)	8 nf (1...10)
Switching output		
ID-No.	P41017	P41018
Type	KGK 007 GSP	KGK 007 GOP
Supply voltage [V]	10...55 DC	10...55 DC
Switching current [mA]	400	400
Short circuit proof	•	•
Overcurrent release [mA]	800	800
Reverse protection	•	•
Voltage drop max. [V]	1.5	1.5
Residual current [mA]	0.2	0.2
Current consumption (not actuated) [mA]	4	12
Switching frequency [Hz]	25	25
Ambient temperature [°C]	-25...+70	-25...+70
EMC-class	A	A
Protection [EN 60529]	IP 67	IP 67
LED display	•	•
Housing material	PPO	PPO
Connection	2 m PVC-cable 3x0.5 mm ²	2 m PVC-cable 3x0.5 mm ²
Connection diagram		
Accessories (see page 4.29)	Fixing nuts are part of delivery	

Standard switches

Series KGM
Metal-thread
M30x1.5

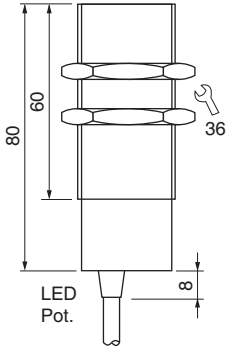
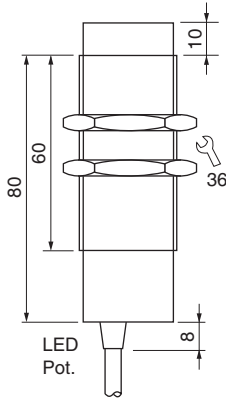
DC 10...55 V



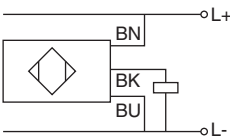
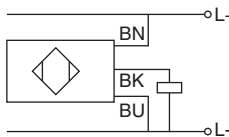

Design	DC PNP • M30x1.5		DC PNP • M30x1.5	
Dimensions				
Installation flush (f) non flush (nf)				
Operating distance sn [mm] (Adjustable range)	10 f (3...15)	10 f (3...15)	15 nf (3...20)	15 nf (3...20)
Switching output				
ID-No.	P40072	P40073	P40076	P40077
Type	KGM 012 GSP	KGM 012 GOP	KGM 015 GSP	KGM 015 GOP
Supply voltage [V]	10...55 DC	10...55 DC	10...55 DC	10...55 DC
Switching current [mA]	400	400	400	400
Short circuit proof	•	•	•	•
Overcurrent release [mA]	800	800	800	800
Reverse protection	•	•	•	•
Voltage drop max. [V]	1.5	1.5	1.5	1.5
Residual current [mA]	0.2	0.2	0.2	0.2
Current consumption (not actuated) [mA]	4	12	4	12
Switching frequency [Hz]	25	25	25	25
Ambient temperature [°C]	-25...+70	-25...+70	-25...+70	-25...+70
EMC-class	A	A	A	A
Protection [EN 60529]	IP 67	IP 67	IP 67	IP 67
LED display	•	•	•	•
Housing material	Br-Ni / PPO	Br-Ni / PPO	Br-Ni / PPO	Br-Ni / PPO
Connection	2 m PVC-cable 3x0.5 mm ²	2 m PVC-cable 3x0.5 mm ²	2 m PVC-cable 3x0.5 mm ²	2 m PVC-cable 3x0.5 mm ²
Connection diagram				
Accessories (see page 4.29)	Fixing nuts are part of delivery			

Standard switches

Series KGM
Metal-thread
M30x1.5

AC 20...250 V

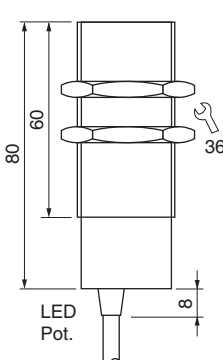
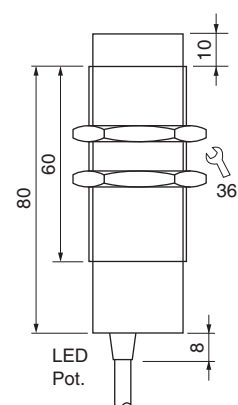
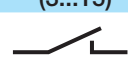
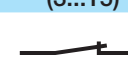

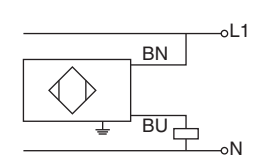
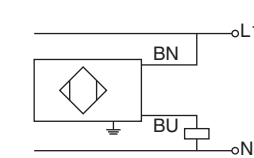



Design	AC • M30x1.5		AC • M30x1.5	
Dimensions				
Installation flush (f) non flush (nf)	f		nf	
Operating distance sn [mm] (Adjustable range)	10 f (3...15)	10 f (3...15)	15 nf (3...20)	15 nf (3...20)
Switching output				
ID-No.	P40007	P40008	P40009	P40010
Type	KGM 012 WS	KGM 012 WO	KGM 015 WS	KGM 015 WO
Supply voltage [V]	20...250 AC	20...250 AC	20...250 AC	20...250 AC
Switching current at 25 °C. AC 12 [mA]	400	400	400	400
Short circuit proof	3000 mA/10 ms	3000 mA/10 ms	3000 mA/10 ms	3000 mA/10 ms
Overcurrent release [mA]	-	-	-	-
Reverse protection	-	-	-	-
Voltage max. [V]	10	10	10	10
Minimum load current [mA]	5	5	5	5
Current consumption max. [mA]	2.5	2.5	2.5	2.5
Switching frequency [Hz]	15	15	15	15
Ambient temperature [°C]	-25...+70	-25...+70	-25...+70	-25...+70
EMC-class	A	A	A	A
Protection [EN 60529]	IP 67	IP 67	IP 67	IP 67
LED display	•	•	•	•
Housing material	Br-Ni / PPO	Br-Ni / PPO	Br-Ni / PPO	Br-Ni / PPO
Connectiob	2 m PVC-cable 3x0.5 mm ²	2 m PVC-cable 3x0.5 mm ²	2 m PVC-cable 3x0.5 mm ²	2 m PVC-cable 3x0.5 mm ²
Connection diagram				
Accessories (see page 4.29)	Fixing nuts are part of delivery			

Standard switches

Series KGK
Plastic-thread
M30x1.5

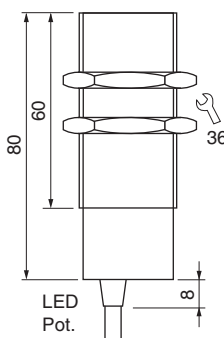
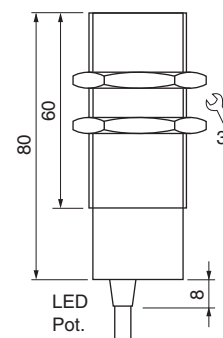
DC 10...55 V
AC 20...250 V

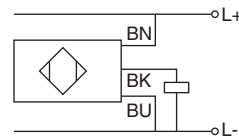
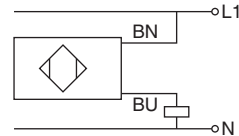

Design	DC PNP • M30x1.5		AC • M30x1.5	
Dimensions				
Installation flush (f) non flush (nf)				
Operating distance sn [mm] (Adjustable range)	15 nf (3...20)	15 nf (3...20)	15 nf (3...20)	15 nf (3...20)
Switching output				
ID-No.	P40080	P40081	P40011	P40012
Type	KGK 015 GSP	KGK 015 GOP	KGK 015 WS	KGK 015 WO
Supply voltage [V]	10...55 DC	10...55 DC	20...250 AC	20...250 AC
Switching current at 25 °C. AC 12 [mA]	400	400	400	400
Short circuit proof	•	•	3000 mA/10 ms	3000 mA/10 ms
Overcurrent release [mA]	800	800	-	-
Reverse protection	•	•	-	-
Voltage drop max. [V]	1.5	1.5	10	10
Minimum load current [mA]	0.2	0.2	4	12
Current consumption (not actuated) [mA]	4	12	2.5	2.5
Switching frequency [Hz]	25	25	15	15
Ambient temperature [°C]	-25...+70	-25...+70	-25...+70	-25...+70
EMC-class	A	A	A	A
Protection [EN 60529]	IP 67	IP 67	IP 67	IP 67
LED display	•	•	•	•
Housing material	PPO	PPO	PPO	PPO
Connection	2 m PVC-cable 3x0.5 mm ²	2 m PVC-cable 3x0.5 mm ²	2 m PVC-cable 2x0.5 mm ²	2 m PVC-cable 2x0.5 mm ²
Connection diagram				
Accessories (see page 4.29)	Fixing nuts are part of delivery			

Standard switches

Series KNK
Plastic-thread
Ø 20 mm

DC 10...55 V



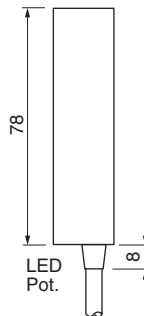
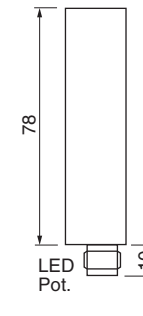
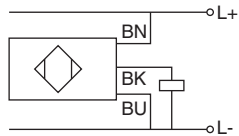
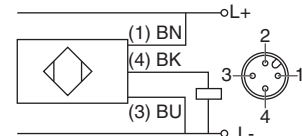



Design	DC PNP • Ø 20 mm		DC PNP • Ø 20 mm	
Dimensions				
Installation flush (f) non flush (nf)				
Operating distance sn [mm] (Adjustable range)	10 nf (1...15)	10 nf (1...15)	10 nf (1...15)	10 nf (1...15)
Switching output				
ID-No.	P40092	P40093	P41208	P41209
Type	KNK 015 GSP	KNK 015 GOP	KNKU 015 GSP	KNKU 015 GOP
Supply voltage [V]	10...55 DC	10...55 DC	10...55 DC	10...55 DC
Switching current [mA]	400	400	400	400
Short circuit proof	•	•	•	•
Overcurrent release [mA]	800	800	800	800
Reverse protection	•	•	•	•
Voltage drop max. [V]	1.5	1.5	1.5	1.5
Residual current [mA]	0.2	0.2	0.2	0.2
Current consumption (not actuated) [mA]	4	12	4	12
Switching frequency [Hz]	25	25	25	25
Ambient temperature [°C]	-25...+70	-25...+70	-25...+70	-25...+70
EMC-class	A	A	A	A
Protection [EN 60529]	IP 67	IP 67	IP 67	IP 67
LED display	•	•	•	•
Housing material	PBT	PBT	PBT	PBT
Connection	2 m PVC-cable 3x0.5 mm ²	2 m PVC-cable 3x0.5 mm ²	M12 connector	M12 connector
Connection diagram				
Accessories (see page 4.28)	Mounting clamps Ø 20 mm (Z00100) are part of delivery			

Standard switches

Series KNK
Smooth-body switches
Ø 34 mm

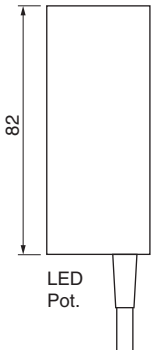
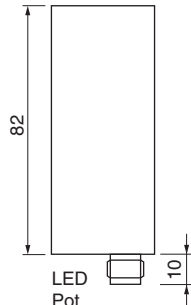
DC 10...55 V



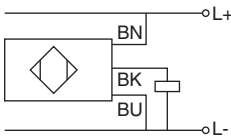
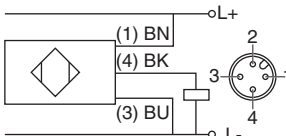



Design	DC PNP • Ø 34 mm		DC PNP • Ø 34 mm	
Dimensions				
Installation flush (f) non flush (nf)				
Operating distance sn [mm] (Adjustable range)	20 nf (1...30)	20 nf (1...30)	20 nf (1...30)	20 nf (1...30)
Switching output				
ID-No.	P40096	P40097	P41220	P41221
Type	KNK 025 GSP	KNK 025 GOP	KNKU 025 GSP	KNKU 025 GOP
Supply voltage [V]	10...55 DC	10...55 DC	10...55 DC	10...55 DC
Switching current [mA]	400	400	400	400
Short circuit proof	•	•	•	•
Overcurrent release [mA]	800	800	800	800
Reverse protection	•	•	•	•
Voltage drop max. [V]	1.5	1.5	1.5	1.5
Residual current [mA]	0.2	0.2	0.2	0.2
Current consumption (not actuated) [mA]	4	12	4	12
Switching frequency [Hz]	25	25	25	25
Ambient temperature [°C]	-25...+70	-25...+70	-25...+70	-25...+70
EMC-class	A	A	A	A
Protection [EN 60529]	IP 67	IP 67	IP 67	IP 67
LED display	•	•	•	•
Housing material	PBT	PBT	PBT	PBT
Connection	2 m PVC-cable 3x0.5 mm ²	2 m PVC-cable 3x0.5 mm ²	M12 connector	M12 connector
Connection diagram				
Accessories (see page 4.28)	Mounting clamps Ø 34 mm (Z00102) are part of delivery			

Standard switches

Series KNK
Smooth-body switches
Ø 20 mm
Ø 34 mm

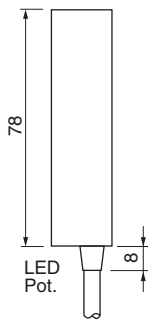
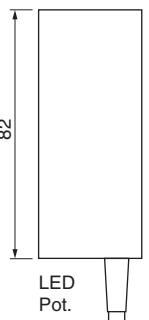
AC 20...250 V



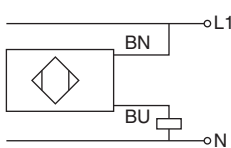
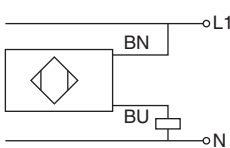



Design	AC • Ø 20 mm		AC • Ø 34 mm	
Dimensions				
Installation flush (f) non flush (nf)				
Operating distance sn [mm] (Adjustable range)	10 nf (1...15)	10 nf (1...15)	20 nf (1...30)	20 nf (1...30)
Switching output				
ID-No.	P40017	P40018	P40019	P40020
Type	KNK 015 WS	KNK 015 WO	KNK 025 WS	KNK 025 WO
Supply voltage [V]	20...250 AC	20...250 AC	20...250 AC	20...250 AC
Switching current [mA]	400	400	400	400
Short circuit proof	3000 mA/10 ms	3000 mA/10 ms	3000 mA/10 ms	3000 mA/10 ms
Overcurrent release [mA]	-	-	-	-
Reverse protection	-	-	-	-
Voltage drop max. [V]	10	10	10	10
Minimum load current [mA]	5	5	5	5
Current consumption max. [mA]	2.5	2.5	2.5	2.5
Switching frequency [Hz]	15	15	15	15
Ambient temperature [°C]	-25...+70	-25...+70	-25...+70	-25...+70
EMC-class	A	A	A	A
Protection [EN 60529]	IP 67	IP 67	IP 67	IP 67
LED display	•	•	•	•
Housing material	PBT	PBT	PBT	PBT
Connection	2 m PVC-cable 2x0.5 mm ²	2 m PVC-cable 2x0.5 mm ²	2 m PVC-cable 2x0.5 mm ²	2 m PVC-cable 2x0.5 mm ²
Connection diagram				
Accessories (see page 4.29)	Mounting clamps Ø 20 mm (Z00100) bzw. Ø 34 mm (Z00102) are part of delivery			

Long sensing range

Series KD
Plastic-housing
Ø 80 mm

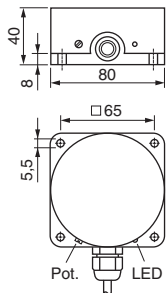
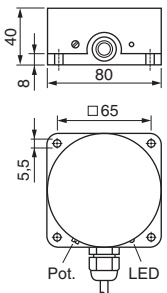
DC 10...55 V
AC 20...250 V

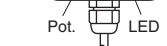

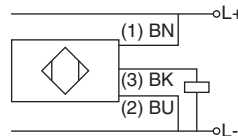
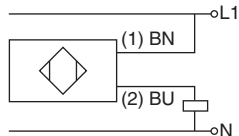

Design	DC PNP • Ø 80 mm	AC • Ø 80 mm
Dimensions		
Installation flush (f) non flush (nf)		
Operating distance sn [mm] (Adjustable range)	55 nf (1...70)	55 nf (1...70)
Switching output		
ID-No.	P40100	P40021
Type	KD 080 GSP	KD 080 WS
Supply voltage [V]	10...55 DC	20...250 AC
Switching current [mA]	400	400
Short circuit proof	•	3000 mA/10 ms
Overcurrent release [mA]	800	-
Reverse protection	•	-
Voltage drop [V]	1.5	10
Residual current [mA]	0.2	-
Minimum load current [mA]	-	5
Current consumption [mA]	4 (not actuated)	2,5
Switching frequency [Hz]	10	10
Ambient temperature [°C]	-25...+70	-25...+70
EMC-class	A	A
Protection [EN 60529]	IP 67	IP 67
LED display	•	•
Housing material	PBT	PBT
Connection	2 m PVC-cable 3x0.5 mm ² (PG plug connection)	2 m PVC-cable 2x0.5 mm ² (PG plug connection)
Connection diagram		
Accessories	see page 4.30	

Long sensing range

Series KNK
Plastic-housing
Ø 100 mm

DC 10...55 V
AC 20...250 V

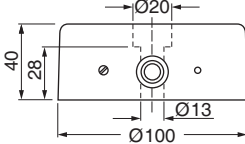
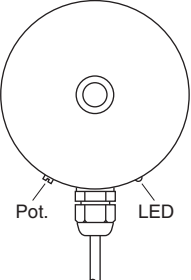

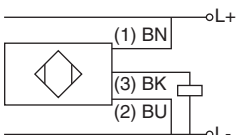
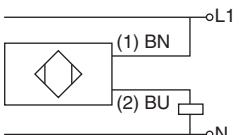
Design	DC PNP • Ø 100 mm	AC • Ø 100 mm
Dimensions Installation flush (f) non flush (nf)		
Operating distance sn [mm] (Adjustable range)	70 nf (1...120)	70 nf (1...120)
Switching output		
ID-No.	P40105	P40023
Type	KNK 090 GSP	KNK 090 WS
Supply voltage [V]	10...55 DC	20...250 AC
Switching current [mA]	400	400
Short circuit proof	•	3000 mA/10 ms
Overcurrent release [mA]	800	-
Reverse protection	•	-
Voltage drop [V]	1.5	10
Residual current [mA]	0.2	-
Minimum load current [mA]	-	5
Current consumption [mA]	4 (not actuated)	2.5
Switching frequency [Hz]	10	10
Ambient temperature [°C]	-25...+70	-25...+70
EMC-class	A	A
Protection [EN 60529]	IP 67	IP 67
LED display	•	•
Housing material	PBT	PBT
Connection	2 m PVC-cable 3x0.5 mm ² (PG plug connection)	2 m PVC-cable 2x0.5 mm ² (PG plug connection)
Connection diagram		
Accessories	see page 4.29	





All-PTFE-housing

Series KGFW
PTFE-housing
M30x1.5

DC 10...55 V

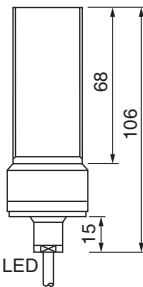
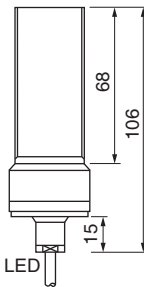
Suitable for use in the food industry
Chemical resistant

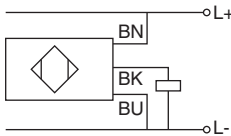
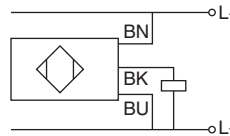

Design	DC PNP • M30x1.5		DC PNP • M30x1.5	
Dimensions				
Installation flush (f) non flush (nf)				
Operating distance sn [mm]	10 f	10 f	14 nf	14 nf
Switching output				
ID-No.	P41268	P41269	P41280	P41281
Type	KGFW 010 GSP	KGFW 010 GOP	KGFW 015 GSP	KGFW 015 GOP
Supply voltage [V]	10...55 DC	10...55 DC	10...55 DC	10...55 DC
Switching current [mA]	400	400	400	400
Short circuit proof	•	•	•	•
Overcurrent release [mA]	800	800	800	800
Reverse protection	•	•	•	•
Voltage drop max. [V]	1.5	1.5	1.5	1.5
Residual current [mA]	0.2	0.2	0.2	0.2
Current consumption (not actuated) [mA]	4	12	4	12
Switching frequency [Hz]	25	25	25	25
Ambient temperature [°C]	-25...+90	-25...+90	-25...+90	-25...+90
EMC-class	A	A	A	A
Protection [EN 60529]	IP 68	IP 68	IP 68	IP 68
LED display	•	•	•	•
Housing material	PTFE / PVDF	PTFE / PVDF	PTFE / PVDF	PTFE / PVDF
Connection	2 m FEP-cable 3x0.34 mm ²	2 m FEP-cable 3x0.34 mm ²	2 m FEP-cable 3x0.34 mm ²	2 m FEP-cable 3x0.34 mm ²
Connection diagram				
Accessories (see page 4.29)	Fixing nuts PTFE (Z00120) are not part of delivery			



All-PTFE-housing

Series KGFW
PTFE-housing
M30x1.5

DC 10...55 V

Suitable for use in the food industry
Chemical resistant

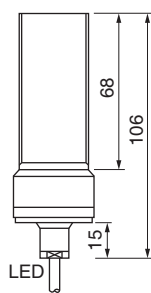
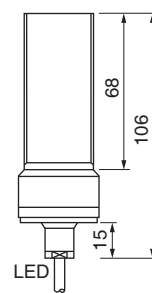

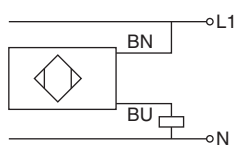

Design	AC • M30x1,5	AC • M30x1,5
Dimensions		
Installation flush (f) non flush (nf)		
Operating distance sn [mm]	10 f	14 nf
Switching output		
ID-No.	P41266	P41278
Type	KGFW 010 WS	KGFW 015 WS
Supply voltage [V]	20...250 AC	20...250 AC
Switching current [mA]	400	400
Short circuit proof	3000 mA/10 ms	3000 mA/10 ms
Overcurrent release [mA]	-	-
Reverse protection	-	-
Voltage drop [V]	10	10
Minimum load current [mA]	5	5
Current consumption [mA]	2.5	2.5
Switching frequency [Hz]	15	15
Ambient temperature [°C]	-25...+90	-25...+90
EMC-class	A	A
Protection [EN 60529]	IP 68	IP 68
LED display	•	•
Housing material	PTFE / PVDF	PTFE / PVDF
Connection	2 m Silicone-cable 2x0.75 mm ²	2 m Silicone-cable 2x0.75 mm ²
Connection diagram		
Accessories (see page 4.29)	Fixing nuts PTFE (Z00120) are not part of delivery	

All-PTFE-housing

Series KNFW
PTFE-housing
Ø 35 mm

DC 10...55 V
AC 20...250 V

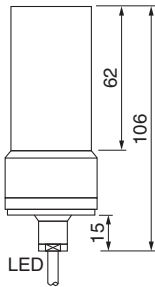
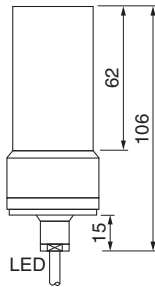

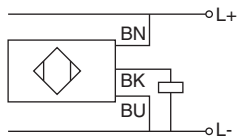
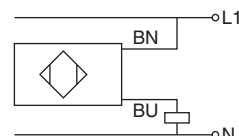
Design	DC PNP • Ø 35 mm		AC • Ø 35 mm
Dimensions			
Installation flush (f) non flush (nf)			
Operating distance sn [mm]	20 nf		20 nf
Switching output			
ID-No.	P41292	P41293	P41290
Type	KNFW 020 GSP	KNFW 020 GOP	KNFW 020 WS
Supply voltage [V]	10...55 DC	10...55 DC	20...250 AC
Switching current [mA]	400	400	400
Short circuit proof	•	•	3000 mA/10 ms
Overcurrent release [mA]	800	800	-
Reverse protection	•	•	-
Voltage drop max. [V]	1.5	1.5	10
Residual current [mA]	0.2	0.2	-
Minimum load current [mA]	-	-	5
Current consumption (not actuated) [mA]	4	12	2.5
Switching frequency [Hz]	10	10	10
Ambient temperature [°C]	-25...+90	-25...+90	-25...+70
EMC-class	A	A	A
Protection [EN 60529]	IP 68	IP 68	IP 68
LED display	•	•	•
Housing material	PTFE / PVDF	PTFE / PVDF	PTFE / PVDF
Connection	2 m FEP-cable 3x0.34 mm ²	2 m FEP-cable 3x0.34 mm ²	2 m Silicone-cable 2x0.75 mm ²
Connection diagram			
Accessories (see page 4.29)	Mounting clamps PTFE (Z00125) are not part of delivery		

Capacitive Sensors



200 °C – High temperature

Series KGMT
Proximity switch for high temperature

Temperature range –40...+200 °C
Level detection
Dry run protection
PTFE sensor-tip, stainless steel housing

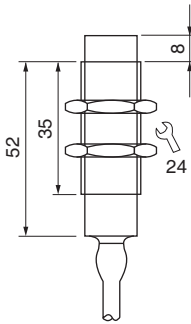
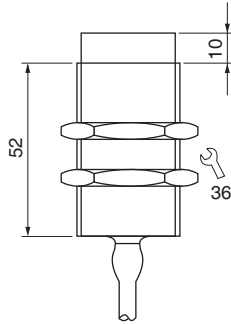
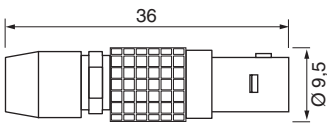

Design	M18x1	M30x1.5
Dimensions		
Installation flush (f) non flush (nf)		
Operating distance sn [mm]	5 nf	10 nf
Amplifier	KK 030... KU 120...	KK 030... KU 120...
ID-No.	P41301	P41302
Type	KGMT 05 S-200	KGMT 10 S-200
Hysteresis [%]	approx. 10	approx. 10
Temperature range sensor [°C]	–40...+200	–40...+200
Temperature range cable [°C]	–40...+200	–40...+200
Compressive strength [bar]	2	2
Protection [EN 60529] Sensor	IP 67	IP 67
Protection [EN 60529] plug	IP 54	IP 54
Housing material	AISI 316 Ti / PTFE	AISI 316 Ti / PTFE
Connection	2 m PTFE-cable LEM 01 plug system	2 m PTFE-cable LEM 01 plug system
LEM plug system		
Cable plug housing LEM 01		
Accessories	Amplifiers see page 4.23	

Analog sensors

Series KGA / KDA Metal thread

M30x1.5
Ø 80 mm

4...20 mA

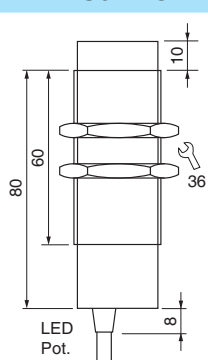
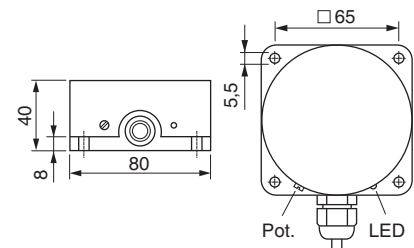
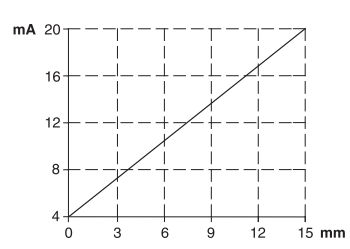
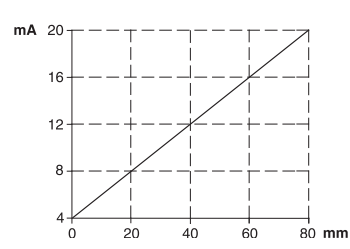
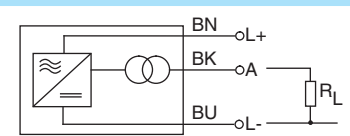

Design	M30x1.5	Ø 80 mm
Dimensions		
Installation flush (f) non flush (nf)	LED Pot.	Pot. LED
Analog range [mm]	0...15 nf	0...80 nf
ID-No.	P41309	P41310
Type	KGA 015 GI	KDA 080 GI
Supply voltage [V]	18...27 DC	18...27 DC
Current consumption max. [mA]	40	40
Output current max. [mA]	23	23
Linearity deviation [% of scale]	±10	±10
Load resistance RL [kΩ]	<0.4	<0.4
Ambient temperature [°C]	-25...+70	-25...+70
Temperature deviation max. [% of scale]	10	10
Protection [EN 60529]	IP 67	IP 67
Housing material	Br-Ni / PPO	PBT
Connection	2 m PVC-cable 3x0.5 mm ²	2 m PVC-cable 3x0.5 mm ²
Output signal		
Connection diagram		
Accessories	Fixing nuts are part of delivery	

Amplifiers





Series KK-KU

For sensors
up to +230 °C

IP 67 protection

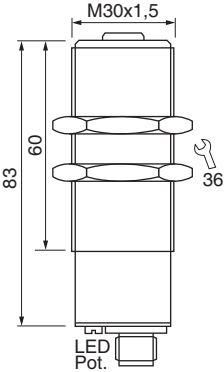
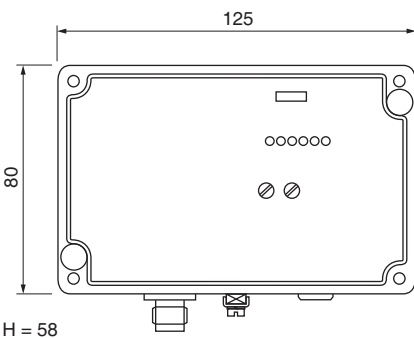
LED display

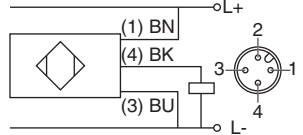
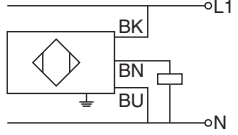

Design	KK 030...		KU 120...		
Dimensions					
Sensing point sp	adjustable		adjustable		
Switching output					
ID-No.	P21095		P21107	P21118	P21117
Type	KK 030 GSP		KU 120 GPP-24	KU 120 WP-230	KU 120 WP-115
Supply voltage [V]	16...55 DC		24 DC ±20%	230 AC ±10%	115 AC ±10%
Current consumption [mA]	15			50	
Switching current max. [mA]	200			400	
Hysteresis [%]	10			10 (adjustable)	
Switching frequency [Hz]	15			5	
Ambient temperature [°C]	-5...+60			-20...+60	
EMC-class	A			A	
Protection housing [EN 60529]	IP 67			IP 65	
connection	IP 54			IP 54	
Function indicator	LED yellow			LED array	
Stand-by indicator	LED green			•	
Housing material	AISI 316 Ti			Aluminium	
Sensor connection	LEM 01 plug			LEM 01 plug	
Connection	M12 connector		M12 connector	2 m PVC-cable 4x0.75 mm ²	
Connection diagram					
Accessories	Connecting cable SLG 3... or SLW 3... see page 4.28				





Dust - Compact model • Zone 22

Series KGEX - Level controller

Category 3
Dust  Zone 22

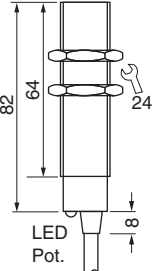
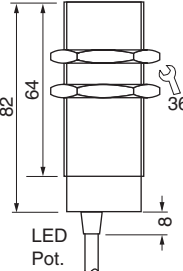
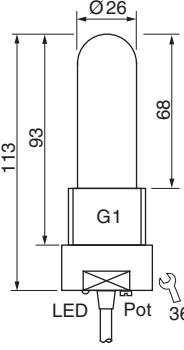
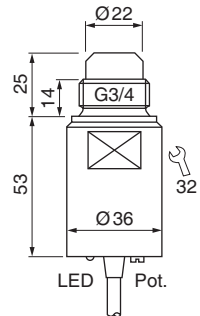
DC 24 V
PNP switching output



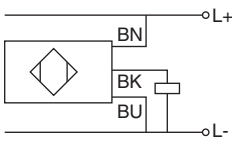

Design	M18x1	M30x1.5	DC PNP • G1	DC PNP • G3/4
Dimensions				
Installation flush (f) non flush (nf)				
Switching point sp (Adjustable range)	5 f (1...7)	10 f (3...15)	-6	-3
Switching output				
ID-No.	P21170	P21171	P21172	P21173
Type	KGEX 018 GSP	KGEX 030 GSP	KGEX 100 GSP	KGEX 107 GSP
Ex marking	II 3D Ex mc IIIC T 80 °C Dc IP 67			
Supply voltage [V]	10...55 DC			
Switching current [mA]	300			
Short circuit proof	•			
Overcurrent release [mA]	800			
Reverse protection	•			
Voltage drop max. [V]	1.5			
Current consumption [mA]	4			
Switching frequency [Hz]	25	25	10	10
Ambient temperature [°C]	-25...+70			
EMC-class	A			
LED display	•			
Housing material	Br-Ni / PPO	Br-Ni / PPO	PTFE	PTFE / AISI 316 Ti FPM
Protection [EN 60529]	IP 67			
Connection	2 m PVC-cable 3x0.5 mm ²			
Note: Do not use in the presence of conductive dusts				
Note	Fixing nuts are part of delivey			

Accessories • M12 connector

System SL

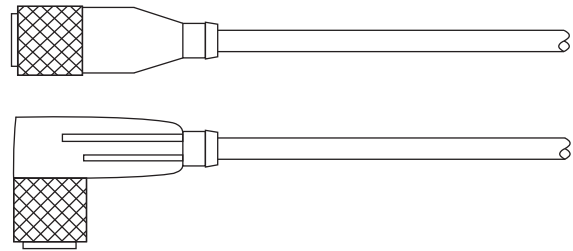
Finished cable plug housing
Self locking screw plug
Protection IP 67

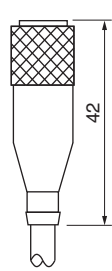
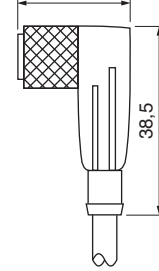
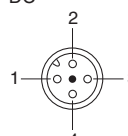
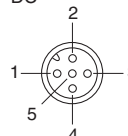
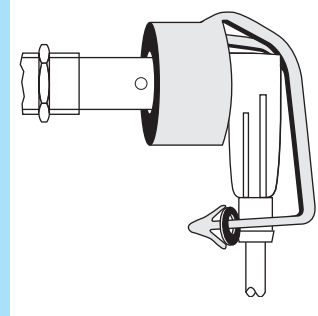

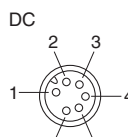
Cable plug housing		Pin-assignment		Plug-lock
<p>straight</p>  <p>42</p>	<p>angular</p>  <p>26,5</p> <p>38,5</p>	<p>DC</p>  <p>3-wire</p> <p>1: BN 2: - 3: BU 4: BK</p>	<p>DC</p>  <p>4-wire</p> <p>1: BN 2: WH 3: BU 4: BK</p>	
<p>DC</p>  <p>5-wire</p> <p>1: BN 2: WH 3: BU 4: BK 5: GY</p>	<p>DC</p>  <p>6-wire</p> <p>1: BN 2: WH 3: BU 4: BK 5: GY 6: PK</p>			
SLG...	SLW...	DC		PL-M12

TYPE	ID-NO.	DESIGN
SLG 3-2	Z01076	Cable plug housing straight, 2 m cable 3x0.34 mm ² max. 250 V / 4 A
SLG 3-5	Z01077	Cable plug housing straight, 5 m cable 3x0.34 mm ² max. 250 V / 4 A
SLW 3-2	Z01078	Cable plug housing angular, 2 m cable 3x0.34 mm ² max. 250 V / 4 A
SLW 3-5	Z01079	Cable plug housing angular, 5 m cable 3x0.34 mm ² max. 250 V / 4 A
SLW 3-2-LED	Z00052	Cable plug housing angular, 2 m cable 3x0.34 mm ² max. 250 V / 4 A PNP with LED
SLG 4-2	Z00445	Cable plug housing straight, 2 m cable 4x0.25 mm ² max. 250 V / 4 A
SLG 4-5	Z00449	Cable plug housing straight, 5 m cable 4x0.25 mm ² max. 250 V / 4 A
SLW 4-2	Z00446	Cable plug housing angular, 2 m cable 4x0.25 mm ² max. 250 V / 4 A
SLW 4-5	Z00450	Cable plug housing angular, 5 m cable 4x0.25 mm ² max. 250 V / 4 A
SLW 4-2-LED	Z01157	Cable plug housing angular, 2 m cable 4x0.25 mm ² max. 250 V / 4 A PNP with LED
SLG 5-2	Z01150	Cable plug housing straight, 2 m cable 5x0.34 mm ² max. 60 V / 2 A
SLW 5-2	Z01151	Cable plug housing angular, 2 m cable 5x0.34 mm ² max. 60 V / 2 A
SLG 6-2	Z01197	Cable plug housing straight, 2 m cable 6x0.25 mm ² max. 36 V / 2 A
SLW 6-2	Z01198	Cable plug housing angular, 2 m cable 6x0.25 mm ² max. 36 V / 2 A
PL-M12	Z01182	Plug-lock for sensors in Ex areas

DATA

Thread	M12x1	Contact resistance	≤ 5 mΩ
Material	PVC	Insulation resistance	>10 ⁹
Protection	IP 67	Testing voltage	2.0 KV eff. / 5 and 6 pol. 1.5 KV eff.
Temperature range	-25...+80 °C		

Note

Sensors with NC output are connected to 4 pole cable plug housings. In this case, the break output is connected to the white lead (connection 2).

Accessories • Mounting accessories

Lock nuts, brass-nickel - plated

ID-NO.	Z00106	Z00107	Z00114	Z00109	Z00110
Nut thickness [mm]	4	4	4	5	5
Thread	M12x1	M18x1	M22x1	M30x1.5	M38x1.5
Spanner size	17	24	27	36	50

Lock nuts, special steel

ID-NO.	Z01098	Z00112	Z00113	Z00115
Nut thickness [mm]	4	4	4	5
Thread	M8x1	M12x1	M18x1	M30x1.5
Spanner size	13	17	24	36

Lock nuts, plastics

ID-NO.	Z00180	Z00120	Z00117	Z00118	Z00119	Z01092	Z01052
Nut thickness [mm]	6	8	4	5	5,5	8	8
Thread	M14x1	M30x1.5	M12x1	M18x1	M30x1.5	G3/4	G1
Spanner size	22	41	17	24	36	41	50
Material	PTFE	PTFE	PPE	PPE	PPE	PTFE	PTFE

Central screw, polyamide

Z00104	M12, length 70 mm, hexagon socket 10 mm, material PA
Z00105	M16, length 90 mm, hexagon socket 14 mm, material PA

MOUNTING CLAMPS

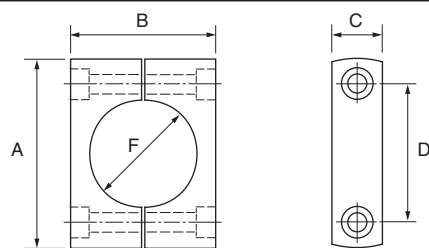
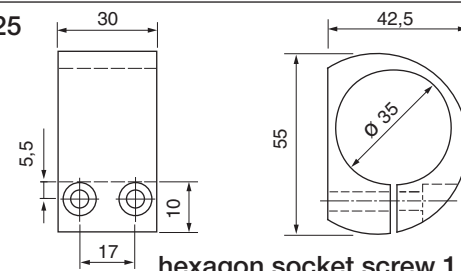
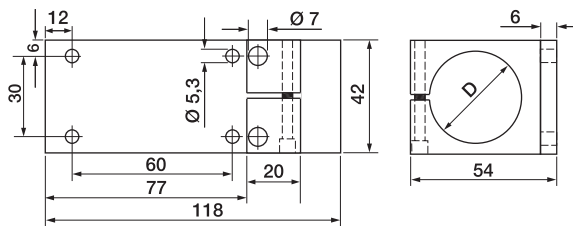
TYPE	ID-NO.	DIMENSIONS	DESIGN																		
KLS 20 KLS 34	Ø 20 Ø 34	Z00100 Z00102	Clamps of PA, for smooth-bodied switches																		
		 <p>E: hexagon socket screw 1.4305</p>	<table border="1"> <thead> <tr> <th>F</th> <th>Ø 20</th> <th>Ø 34</th> </tr> </thead> <tbody> <tr> <td>A</td> <td>47</td> <td>61</td> </tr> <tr> <td>B</td> <td>30</td> <td>47</td> </tr> <tr> <td>C</td> <td>17</td> <td>15</td> </tr> <tr> <td>D</td> <td>32</td> <td>45</td> </tr> <tr> <td>E</td> <td>M5x30</td> <td>M5x50</td> </tr> </tbody> </table>	F	Ø 20	Ø 34	A	47	61	B	30	47	C	17	15	D	32	45	E	M5x30	M5x50
F	Ø 20	Ø 34																			
A	47	61																			
B	30	47																			
C	17	15																			
D	32	45																			
E	M5x30	M5x50																			
KLB 35	Ø 35	Z00125	Clamp of PTFE (Teflon), for smooth-bodied switches hexagon socket screw M5x40																		
		 <p>hexagon socket screw 1.4571</p>																			
KBM 025 KBM 030 KBM 035	Ø 25 Ø 30 Ø 35	Z01189 Z01188 Z01187	Mounting clamp of Aluminium																		
			<table border="1"> <thead> <tr> <th>Type</th> <th>D</th> </tr> </thead> <tbody> <tr> <td>KBM 025</td> <td>Ø 25</td> </tr> <tr> <td>KBM 030</td> <td>Ø 30</td> </tr> <tr> <td>KBM 035</td> <td>Ø 35</td> </tr> </tbody> </table>	Type	D	KBM 025	Ø 25	KBM 030	Ø 30	KBM 035	Ø 35										
Type	D																				
KBM 025	Ø 25																				
KBM 030	Ø 30																				
KBM 035	Ø 35																				

Accessories • Cable

TYPE	ID.-NO.	MATERIAL/SHEATH	\varnothing_A [mm]*	WIRE SPECIFICATION	COLOUR
PVC205	Z01061	PVC, grey	5.2	2x0.5 mm ²	BU, BN
PVC205B	Z01062	PVC, blue	4.4	2x0.5 mm ²	BU, BN
PVC275	Z01086	PVC, grey	6.0	2x0.75 mm ²	BU, BN
PVC275BS	Z01108	PVC, blue	6.3	2x0.75 mm ² shielded	numbered cable
PVC334	Z01109	PVC, grey	4.5	3x0.34 mm ²	BU, BN, BK
PVC305E	Z01064	PVC, grey	5.2	3x0.5 mm ²	BU, BN, GN/YE
PVC305	Z01063	PVC, grey	5.2	3x0.5 mm ²	BU, BN, BK
PVC375	Z01065	PVC, grey	6.0	3x0.75 mm ²	numbered cable
PVC375E	Z01111	PVC, grey	6.0	3x0.75 mm ²	BU, BN, GN/YE
PVC425	Z01110	PVC, grey	4.3	4x0.25 mm ²	BU, BN, BK, WH
PVC434	Z01066	PVC, grey	4.5	4x0.34 mm ²	BU, BN, BK, WH
PVC405	Z01067	PVC, grey	5.5	4x0.5 mm ²	BU, BN, BK, WH
PVC475E	Z01113	PVC, grey	6.5	4x0.75 mm ²	BU, BN, BK, GN/YE
PVC475BS	Z01114	PVC, blue	7.3	4x0.75 mm ² shielded	numbered cable
PVC505	Z01116	PVC, grey	5.8	5x0.5 mm ²	BU, BN, WH, BK, GY
PVC705	Z01117	PVC, grey	6.6	7x0.5 mm ²	BU, BN, WH, GN/YE, GY, PK
PUR334	Z01156	PUR, grey	5.0	3x0.34 mm ²	BU, BN, BK
PUR375	Z01068	PUR, black	6.0	3x0.75 mm ² -40°C	BU, BN, BK
PUR425S	Z01069	PUR, grey	5.0	4x0.25 mm ² shielded	BU, BN, WH, BK
PUR425BS	Z01070	PUR, blue	5.0	4x0.25 mm ² shielded	BU, BN, WH, BK
PUR405	Z01112	PUR, black	5.0	4x0.5 mm ²	BU, BN, WH, BK
PUR475SE	Z01118	PUR, grey	9.0	4x0.75 mm ² shielded	numbered cable
PUR410E	Z01119	PUR, orange	8.0	4x1.0 mm ²	BU, BN, BK, GN/YE
FEP375S	Z01126	FEP, red	5.0	3x0.75 mm ² shielded	BU, BN, BK
FEP334	Z01071	FEP, red	3.8	3x0.34 mm ²	BU, BN, BK
FEP425S	Z01073	FEP, red	4.1	4x0.25 mm ² shielded	BU, BN, BK, WH
FEP425	Z01072	FEP, red	3.7	4x0.25 mm ²	BU, BN, BK, WH
FEP425BS	Z01125	FEP, blue	4.1	4x0.25 mm ² shielded	BU, BN, BK, WH
FEP375	Z01165	FEP, red	4.2	3x0.75 mm ²	BU, BN, GN/YE
Silikon375E	Z01121	Silicone, red	6.0	3x0.75 mm ²	BU, BN, GN/YE
Silikon475E	Z01122	Silicone, red	6.3	4x0.75 mm ²	BU, BN, BK, GN/YE
Silikon475SE	Z01115	Silicone, red	8.8	4x0.75 mm ² shielded	BU, BN, BK, GN/YE
Silikon305	Z01143	Silicone, red	5.5	3x0.5 mm ²	BU, BN, BK
PVC705SE	Z01123	PVC-transparent	9.2	7x0.5 mm ² shielded	numbered cable, GN/YE

*Tolerance of diameter $\pm 0,4$ mm

A selection

Flow sensors

- Electronical monitoring of flow
- Lubrication monitoring
- Measuring range 1 ml/min...100 l/min
- Detection range 1...300 cm/s
- Reaction time 0.5 s

Level sensors

- For level monitoring $-230...+230\text{ }^{\circ}\text{C}$
- Steam proof at a pressure of up to 30 bar
- For hot motor oil
- For liquid nitrogen
- For chemically aggressive media

Ultrasonic

- Switching distance up to 5000 mm
- Level monitoring
- Watertight housing
- Teach-in functions

Pressure sensors

- Compact model with digital display
- Monitoring in pipes and containers
- Pressure up to 16 bar
- Level up to 10 m ($\pm 1\text{ cm}$)
- Programmable

Temperature sensors

- Compact model with digital display
- Monitoring in pipes and containers
- Temperature $-40...+120\text{ }^{\circ}\text{C}$ ($\pm 0,3\text{ }^{\circ}\text{C}$)
- Pressure up to 100 bar
- Multi use output NO/NC + analog

Infrared detectors

- Measurement of temperature
- Monitoring of hot media
- Position control





**Headquarters
EGE-Elektronik
Spezial-Sensoren GmbH**

Ravensberg 34
D-24214 Gettorf
Tel. +49 (0) 4346 / 41580
Fax +49 (0) 4346 / 5658

Internet: www.ege-elektronik.com



EGE-Elektronik ApS
Forstallé 79
DK-6200 Aabenraa
Tel. +45 70207271
Fax +45 70207272



EGE-Specialsenserer AB
Stationsgatan 4
S-51250 Svenljunga
Tel. +46 32512060
Fax +46 32512064



Stork AS
Brynsveien 100
N-1352 Kolsås
Tel. +47 67176400
Fax +47 67176401



Vision Systems OY
PL353
FI-40101 Jyväskylä
Tel. +358 (0)10 322 7100
Fax +358 (0)10 322 7119



Molex France
18 Parc Burospace
F-91571 Bièvres Cedex
Tel. +33 2 32 96 04 28
Fax +33 2 32 96 04 21



Cematic-Electric B.V.
Postbus 777
NL-7550 AT Hengelo
Tel. +31 742433422
Fax +31 742913333



ICM Ital Control Meters Srl
Via della Valle 67
I-20048 Carate Brianza (Mi)
Tel. +39 0362 8052 00
Fax +39 0362 8052 01



Bibus Spain, S. L.
Rua do Arroncal, Vial C – Nave 4A
ES-36350 Nigran
Tel. +34 986 247286
Fax +34 986 209247



Powelectrics Limited
Sandy Hill Park, Sandy Way
Amington, Tamworth
GB-Staffordshire B77 4DU
Tel. +44 1827310666
Fax +44 1827310999



Bachofen AG
Ackerstraße 42
CH-8610 Uster
Tel. +41 449441111
Fax +41 449441233



VWR International GmbH
Graumanngasse 7
A-1150 Wien
Tel. +43 1 97 002 - 0
Fax +43 1 97 002 - 600



Countapulse Controls (PTY) LTD.
P.O.B. 40393
ZA-2022 Cleveland
Tel. +27 116157556
Fax +27 116157513



HITECH Ltd.
1-35-2 Simouma, Setagaya,
JPN-Tokyo 154-0002
Tel. +81 35430 2301
Fax +81 35430 2302



Micromax S&A P/L
Unit 2 106-110 Beaconsfield Street
AUS-Silverwater NSW 2128
Tel. +61 1300 362626
Fax +61 1300 017100



**PROTEK TEKNİK ELEKTRİK
TİC. SAN. LTD. ŞTİ.**
Okçumusa Cad. Kismet Han
No: 36/2 P.K.
TR-34420 Karaköy-Istanbul
Tel. +90 212 237 20 00
Fax +90 212 235 46 09



IAC & Associates
2180 Fasan Drive
Oldcastle
CDN-Ontario N0R 1L0
Tel. +1 519 7370311
Fax +1 519 7370314
TF +1 800 711 1900



Yuden-Tech Co., Ltd.
5F., No. 121, Lide St.,
Zhonghe City, Taipei County 235,
Taiwan (R.O.C.)
Tel. +886 2 8221 2958
Fax +886 2 8221 2492



**Shanghai Beishidietian
Business Trade Co., Ltd.**
4F, No. 88-1, Lane 7039,
Zhongchun Rd., Minhang Area
Shanghai City
Tel. +86 21 54887307
Fax +86 21 54887305



CSE-W. Arthur Fischer Ltd.
15 Polaris Place, Greenmount
NZ-East Tamaki, Auckland
Tel. +64 9271 3810
Fax +64 9265 1362



KOLEKTOR SISTEH d.o.o.
Šlandrova ulica 10
SI-1231 Ljubljana - Črnuče
Slovenija
Tel. +386 1 5636 300
Fax +386 1 7227 930



Introl Sp. z o.o.
ul. Kościuszki 112
40-519 Katowice
Tel. +48 32 789 00 00
Fax +48 32 205 33 77



Bibus Portugal, LDA
Centro Empresarial AAA
Rua Ponte da Pedra, 240 - C4
4470-108 Gueifães - Maia
Porto
Tel. +351 22 906 50 50
Fax +351 22 906 50 53



Futron Electronics PTE Ltd.
1004 Toa Payoh North
#04-08/09/10
Singapore 318995
Tel. +65 6250 2456
Fax +65 6250 6592



Useong Electrade Co.,
D-1006, Technopark
No. 1345, Soha-dong, Gwangmyeong-si
Gyeonggi-do,
Korea
Tel. +82 (0) 2 2686 7314
Fax +82 (0) 2 2686 7316