

## GreenTech EC Technology.

Electronic commutation brings economic benefits.

# ebmpapst

The engineer's choice



# Symbols that define standards.

## **Green through and through.**

In order to underline our philosophy, efforts and achievements when it comes to environmental protection, we have put them all in a nutshell with GreenTech. The benefits of GreenTech mesh with one another from the initial development of our products through to their use – and they form a circuit that finishes right where it began: with the philosophy that we shall soon build another, even more eco-friendly and economical product.

## **Philosophy:**

Each new development must exceed the economic and ecological performance of its predecessor.

## **Development:**

Materials, products and processes are selected and designed in an environmentally responsible manner using state-of-the-art methods.

## **Production:**

State-of-the-art energy, air-conditioning and ventilation technology provides maximum energy efficiency in our plant.

## **Awards:**

Environmental prizes, distinctions and energy efficiency that beats even the most stringent limits speak for themselves.

## **Application:**

Our high-efficiency products use GreenTech EC technology and boast enormous energy savings with top performance.



# Contents.

*In our role as development specialists, the economic success of your products is just as important to us as it is to you. After all, maximum efficiency is always a top priority when we develop fans, blowers and drive concepts for use in a wide variety of applications. Cost efficiency is the aim and energy efficiency is one of the most direct ways of getting there. This approach also involves accepting responsibility for environmental issues. We are sure this brochure will convince you of how ebm-papst GreenTech EC technology can contribute to both economic success and environmental protection – to everybody's advantage.*

Background	4   5
Efficiency	6   7
ErP	8   9
Intelligence	10   11
Comfort	12   13
Comprehensive concept	14   15
Communication	16   19
Software	20   21
EC Control	22   23
EC Clone   Fan Control	24   25
Bluetooth®	26   27
USB adapter	28   29
Ethernet	30   31
EC controller	32   33
Pressure controller	34   35
Pressure sensor/controller	36   37
Pressure sensors	38   39
Temperature sensors/temperature modules	40   43

GreenTech means  
ecologically improving  
every new product.

## GreenTech EC technology: The original.

*EC technology can mean a lot of different things. These days the term is broadly used to refer to a variety of drive concepts such as **PM** (permanent magnet motor), **ECM** (electronically commutated motor) and **BLDC** (brushless DC motor). ebm-papst was one of the first manufacturers to recognise the economic and ecological advantages offered by EC technology and was instrumental in promoting its development. We launched the world's first EC/DC compact fan on the market right back in 1965 – 30 years before any other manufacturer. And so GreenTech EC technology made by ebm-papst is the outstanding product of a consistent efficiency strategy – in other words it is the most authentic EC technology.*

### **The EC technology pioneer: ebm-papst.**

Without doubt the development and advancement of EC technology represented one of our most significant challenges. Today, the largest range of EC fans and motors in the world is evidence of our success. For more than 13 years, mains-powered GreenTech EC technology – used for example in clean room applications – has represented the global standard, guaranteeing reliable operation 24 hours a day every day of the year.

The outstanding ecological and economic advantages offered by GreenTech EC technology make it the ideal choice both for new users

and anyone wishing to convert from AC to EC. The topic of sustainability has long since become a crucial purchasing criterion – not just for our customers but for their customers as well. It goes without saying that we intend to carry on developing and perfecting GreenTech EC technology to make sure we are able to satisfy all the future demands of our customers, the market and society in general – and not least to live up to our own expectations.

### **Motors with a built-in saving effect.**

The most significant advantage of fans and motors employing GreenTech EC technology as opposed to conventional asynchronous motors is that their efficiency level of up to 90% is substantially higher than the 70–80% achieved by AC motors. This means not only better utilisation of primary energy, but also reduced heat loss and hence a longer service life.

The benefits in terms of efficiency are even more apparent in part load operation, as the integrated electronics of EC motors permit infinitely variable control. In this way the speed can always be adapted to the particular requirements. This feature offers added scope for potential savings in a variety of applications, whilst creating a more pleasant atmosphere – thanks to the greatly reduced noise levels for example.



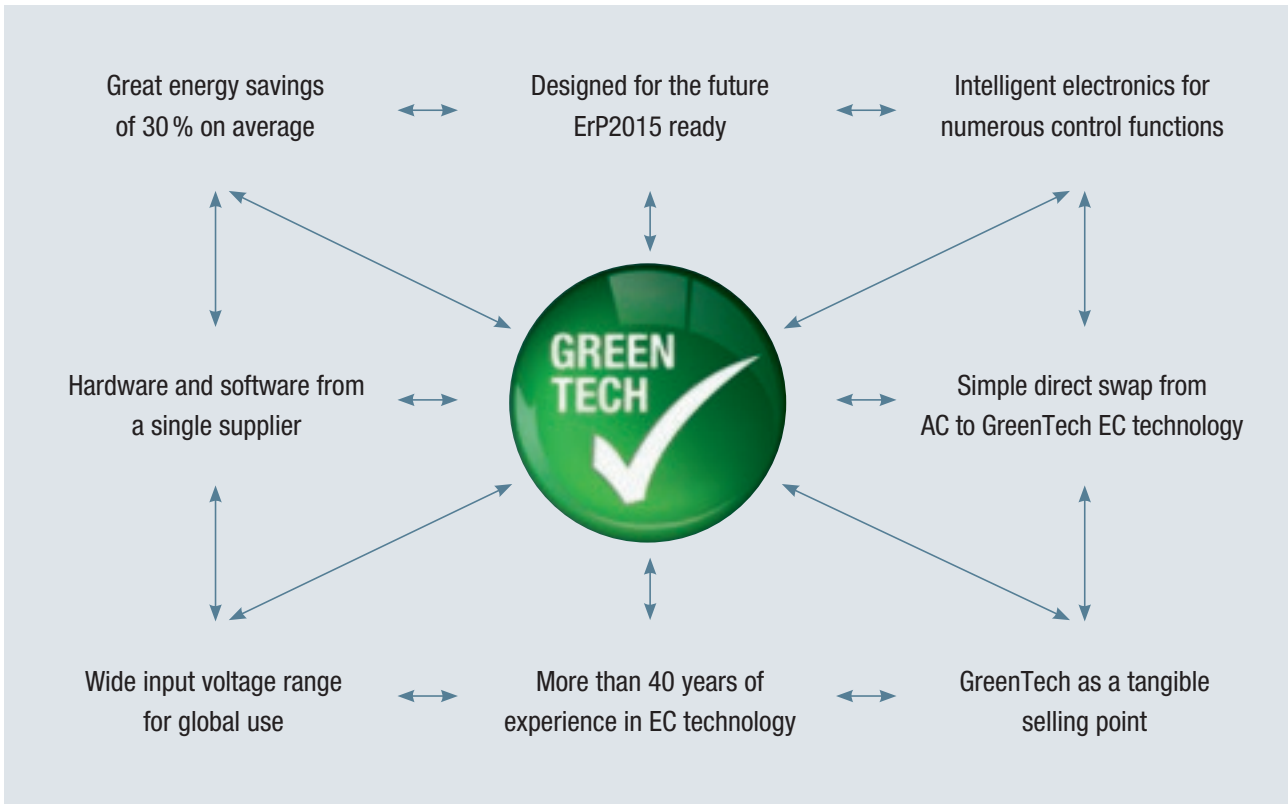

**GreenTech EC – the technology combining the best of all technological worlds.**

In technical terms, GreenTech EC technology can be referred to as “soft commutation”, representing as it does a combination of commutation strategy and motor design. The tangible result for customers is low-noise operation with no structure-borne noise. In other words, we employ various designs of permanent magnet motor to obtain the best possible performance for each application and for every power range required. Intelligent electronics provide compensation for synchronisation tolerances, leaving our customers to enjoy only the positive aspects.

What’s more, GreenTech EC motors and fans can be used absolutely anywhere: They are suitable for operation in both DC and AC systems (single and 3-phase). Size is now no longer a problem either: By completely integrating the electronics into the motor, the dimensions of many of our EC fans are exactly the same as those of their AC equivalents.

So there is no longer any advantage to using conventional AC fans. And this is not just the case for new applications. Changing from AC to EC is well worthwhile in view of the far superior efficiency and could not be easier thanks to plug & play.

# 30% savings on average: A proud claim!

Whether we are talking about ventilation, air conditioning, refrigeration, information technology, heating systems, building systems, industrial automation, automotive engineering or telecommunications – there is a need to save as much energy as possible wherever motors are employed in drive systems or for ventilation. GreenTech EC technology leads by example: All our EC fans already surpass the requirements of the ErP directive for 2015. And that's not just talk, but a proven fact!

### Example: Energy savings in the air conditioning sector.

And here's another fact: Even at varying speeds, GreenTech EC fans maintain their extremely high efficiency levels, whereas there is a sharp drop in the already inferior efficiency of AC motors. In the case of condensers/evaporators operating with our EC fans for example, energy savings of more than 10% can be achieved even just at nominal speed. The relative and absolute savings become yet more apparent with infinitely variable control. As compared to GreenTech EC technology, conventional phase control may require more than twice as much energy depending on the operating point.

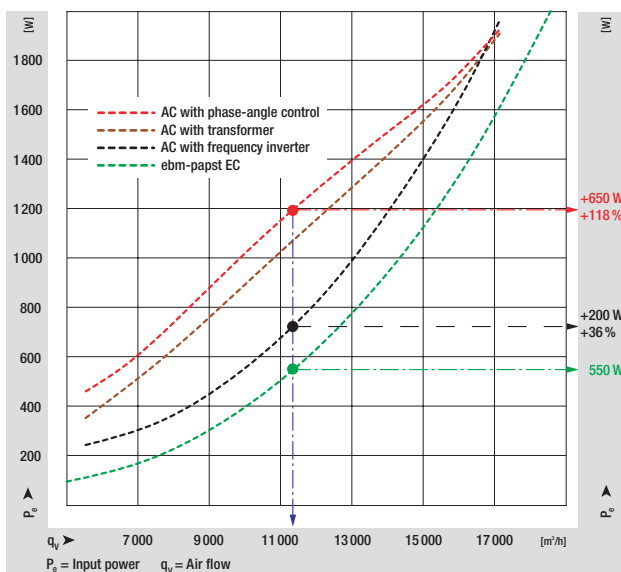

Power consumption for various control methods



## 29 % savings

### E. g. A3G800 axial fan.

A heat exchanger operates with 6 fans. Given an average utilisation rate of 75 %, there is potential for saving more than 24 MWh per year. That corresponds to roughly 14.4 t of CO<sub>2</sub> and represents a saving of 2,814 euro\*.



## 67 % savings

### E. g. W1G200 axial fan.

40 fans operate in refrigerated display cases in a small supermarket. On account of the lower level of heat generated by the energy-saving motor, the operating time is 30 % shorter. This translates into a potential annual saving of more than 9.4 MWh and 5.6 t of CO<sub>2</sub>. Cost saving: 1,080 euro\*.



## 22 % savings

### E. g. R3G500 centrifugal fan.

6 precision air conditioning units, each equipped with 3 GreenTech EC fans, operate in the IT rooms of a computer centre. Given a 100 % duty cycle it is possible to save up to 50 MWh of electricity. That corresponds to around 30 t of CO<sub>2</sub> and 5,898 euro\* per year.

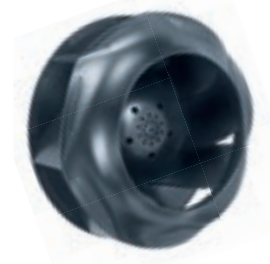

\*Based on CO<sub>2</sub> emissions of 600 kg/MWh (German energy mix) and 11.69 cents/kWh, average price paid by industry for electricity in Germany (as at: January 2010, source: VEA, BDEW).

# Higher Tech: GreenTech EC technology surpasses standards.

*Natural resources do not last for ever, so certain materials are becoming ever scarcer and more expensive. Consequently there is a growing demand for energy-saving products – not just on the part of consumers, but also in the light of new legislation to limit energy consumption and protect the climate. In adopting the Kyoto protocol, the European Union has committed itself to reducing CO<sub>2</sub> emissions by at least 20 per cent by the year 2020. In an effort to achieve this climate goal, minimum requirements were drawn up for energy-consuming products. In June 2010 binding limit values were introduced for fans, regardless of whether these are used as stand-alone units or as component parts of a device or installation. This affects many different sectors, from refrigeration and air conditioning systems right through to machinery and IT applications.*

#### **New limit values highlight the limitations of conventional fans.**

Starting in 2013 and with effect from 2015, two-stage implementation of the ErP directive will enforce more stringent efficiency requirements for fans in the power range between 125 W and 500 kW. The corresponding minimum efficiency values for the various types of fan are stipulated in the EU directive no. 327/2011.

#### **The future belongs to GreenTech EC technology.**

In the light of these developments, the strengths of the innovative GreenTech EC technology created by ebm-papst for electrically driven fans really come to the fore. In contrast to fans employing AC technology, GreenTech EC motors from ebm-papst achieve efficiency levels in excess of 90 per cent, thus permitting substantial energy savings as compared to conventional AC designs. Added to this, the speed of GreenTech EC fans can be regulated to adapt the air volume to the specific requirements. This has the positive effect of considerably reducing energy consumption still further.

#### **GreenTech EC technology is the right answer for motors as well.**

The situation for electric motors is basically the same as for fans. Since June 2011 they have been required by the EU ErP executive order no. 2009/640/EC to at least satisfy efficiency class IE2. Otherwise these motors can no longer be operated in Europe. The directive does not however apply to all of today's commonly used motors: EC external rotor motors, used for example to drive energy-efficient fans, are not subject to this ruling. Comparison of their efficiency levels with the values demanded by this directive does however quite clearly reveal: Innovative GreenTech EC motors from ebm-papst already easily surpass the required efficiency standard.

**ErP2015**  
**EXCEEDS THE NORM**





# Top performance under all conditions: Guaranteed!

*Just one example of flexible fan operation: Air conditioning and refrigeration in a supermarket. This application demands full speed and capacity in summer at peak load, reduced capacity in the winter months and quiet running at low speed during the night. GreenTech EC technology from ebm-papst is the ideal answer under these theoretical but nonetheless realistic conditions. Intelligent control functions make it possible to quite simply adapt air conditioning and cooling to all the requirements of manufacturers, operators, consumers and the general public, whilst guaranteeing considerable savings in terms of both energy and costs.*

## Example: Performance comparison for condensers/evaporators.

The difference between AC and GreenTech EC technology is clearly illustrated by the graph below based on the example of ebm-papst size 800 axial fans: Our EC technology can be employed throughout the entire blue area. What's more, it exhibits considerable reserve capacity in the dark blue area as compared to AC technology. GreenTech EC technology can thus be used for peak load operation – with extremely low running noise.

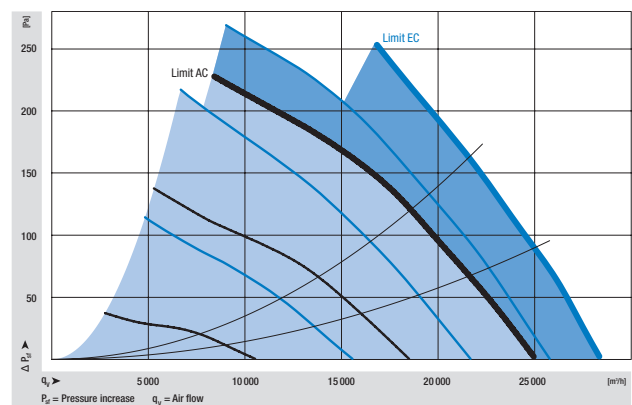

Performance spectrum  
of AC and EC fans

- AC
- EC
- EC reserve capacity



# Just turn down the costs: Truly intelligent!



Here is a practical example of intelligent energy saving: A condenser as used for example in cooling systems can be equipped with 4 AC fans or alternatively with ebm-papst GreenTech EC technology. The energy saving potential with GreenTech as compared to AC fans is quite considerable – as shown by the graphs below.

### Example: You can count on considerable savings potential.

A comparison is made between two condensers, each equipped with four size 800 axial fans: one condenser with conventional AC technology and the other with innovative GreenTech EC technology. The air performance of the fans is adapted so that optimum cooling performance is always attained whatever the cooling requirements.

In the case of the condenser with AC fans, this is often achieved by using external switching devices to switch individual fans off and on. The fans remaining in operation continue to run at full speed.

The condenser with GreenTech EC fans achieves the same effect by way of infinitely variable speed control. All fans thus remain in operation – and far less power is consumed as a result.

The graphs below illustrate the possible energy savings and noise reduction in a direct comparison between on/off operation and infinitely variable speed control:

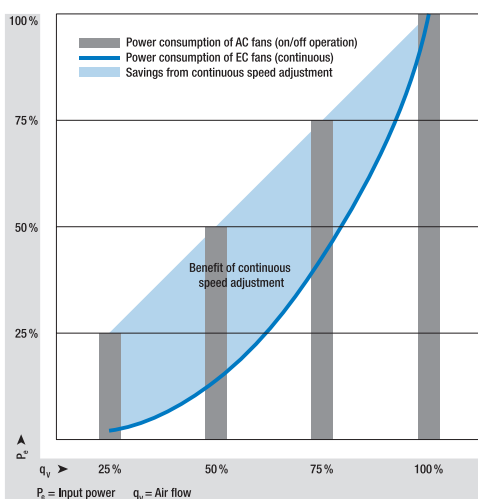

Lower energy consumption: The bars show the power consumption of fans which are switched in gradually as required. The air performance drops by 50% if two fans are switched off. The blue curve shows the power consumption with infinitely variable speed control.

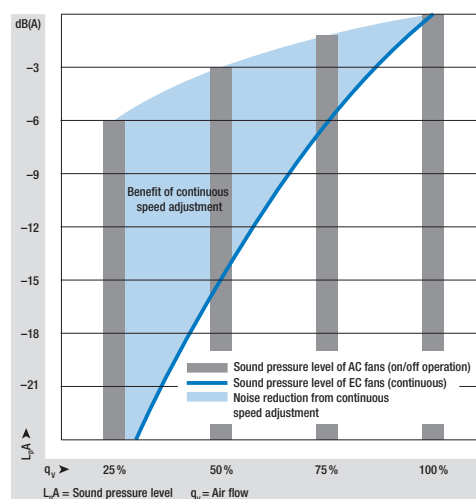

Less noise generation: Whereas switching off half the fans (halving the air flow) only reduces noise generation by approx. 3 dB, speed reduction to half the air flow yields an improvement of 15 dB.

Our example in figures: Direct comparison of four conventional AC fans in on/off operation with four GreenTech EC fans featuring continuous speed control. The table below only reveals the benefits in terms of power consumption. The consistently higher efficiency levels of our GreenTech EC motors mean that the energy savings in real terms are a lot greater again.

**Unrivalled: A win-win situation for operators and the environment!**

Companies, mankind and the environment all benefit from the use of intelligent GreenTech EC technology from ebm-papst. It is not just to the financial advantage of all users, it also – more importantly – helps to conserve valuable resources. But that’s not all. On top of the “saving effect”, you can also expect far lower noise emission levels: GreenTech EC fans run even more quietly at low speed and are thus hardly noticeable.

**On/off operation:** To adapt the air performance to differing cooling requirements, it is still standard practice to switch individual AC fans off and on.

AC Air performance	On/off operation of AC fans		
	Number of fans in operation	Speed	Power consumption in kW
100 %	4	100 %	7.40
75 %	3	100 %	5.55
50 %	2	100 %	3.70
25 %	1	100 %	1.85

**Modulating operation:** All devices and fans remain in operation. Optimum cooling performance is achieved by continuously regulating the speed of all fans.

EC Air performance	Modulated operation: Speed control of GreenTech EC fans		
	Number of fans in operation	Speed	Power consumption in kW
100 %	4	100 %	6.68
75 %	4	75 %	2.84
50 %	4	50 %	0.84
25 %	4	25 %	0.11

**Direct comparison:** Speed control considerably reduces power consumption – even by as much as 94 % given demand-based adaptation to a quarter of the rated capacity.

Air performance	Reduction in power consumption with EC
100 %	10 %
75 %	49 %
50 %	77 %
25 %	94 %

**Specimen calculation:**

**Potential saving in kWh:** With the assumed load profile shown on the right, modulating operation considerably cuts the amount of energy required. Over the course of a year, this amounts to a reduction of 56 %!

Time at load level	Hours per year at load level	AC: Power requirement for on/off operation kWh per year	EC: Power requirement for modulating operation kWh per year
10 % at 100 %	876	6,482	5,852
30 % at 75 %	2,628	14,585	7,464
40 % at 50 %	3,504	12,965	2,943
20 % at 25 %	1,752	3,241	193
	<b>8,760</b>	<b>37,274</b>	<b>16,451</b>

**With this load profile the annual reduction in energy consumption is 56 %**

**Potential saving in euro:** The use of innovative GreenTech EC technology is always a good deal for the operator!

Saving with EC per year (0.09 euro/kWh)	Saving with EC per year (0.12 euro/kWh)	Saving with EC per year (0.15 euro/kWh)	Saving with EC per year (0.18 euro/kWh)
1,874 €	2,499 €	3,123 €	3,748 €

## Minimum noise emissions: Sounds good!

Air conditioning in office buildings, domestic heating systems, range hoods, refrigerators, cooling systems in computers, ventilation and air conditioning in cars and commercial vehicles are just a few examples of applications where functionality, reliability and safety are all important, but – wherever they are – users quite literally do not want to hear anything from them. What you will be pleased to hear: GreenTech EC fans, EC blowers and EC drives made by ebm-papst provide not just perfect, but also barely audible operation in all applications.

### Example: Noise reduction at all speeds.

ebm-papst GreenTech EC technology is “music to the ears” – or rather it isn’t – as there is no motor noise to be heard over the entire speed range. Advantage: Extremely low speeds can be set at night for example when little cooling action is required. The typical resonance encountered in frequency converter operation – which is sometimes even found in the EC products of our rivals – and “phase hum” are ruled out by the design principle of our products.

Also, the combination of AC motors with a frequency converter without an all-pole sine filter can lead to winding and bearing damage.

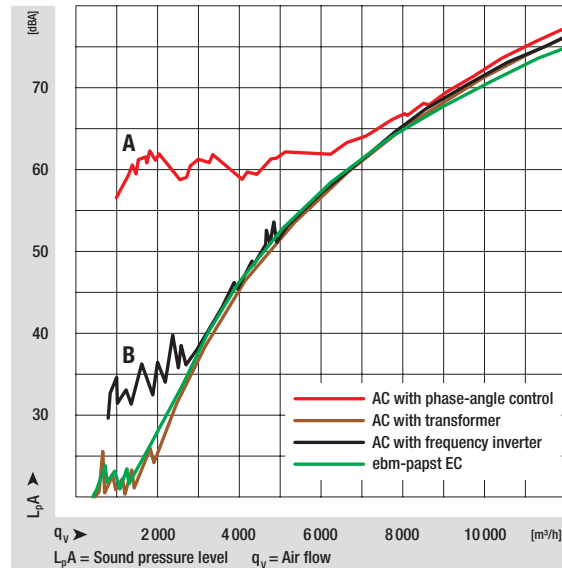

Noise profile with various control methods

A: Phase control, hum (300 Hz)

B: Frequency converter whistling – motor and device resonance caused by motor with frequency converter

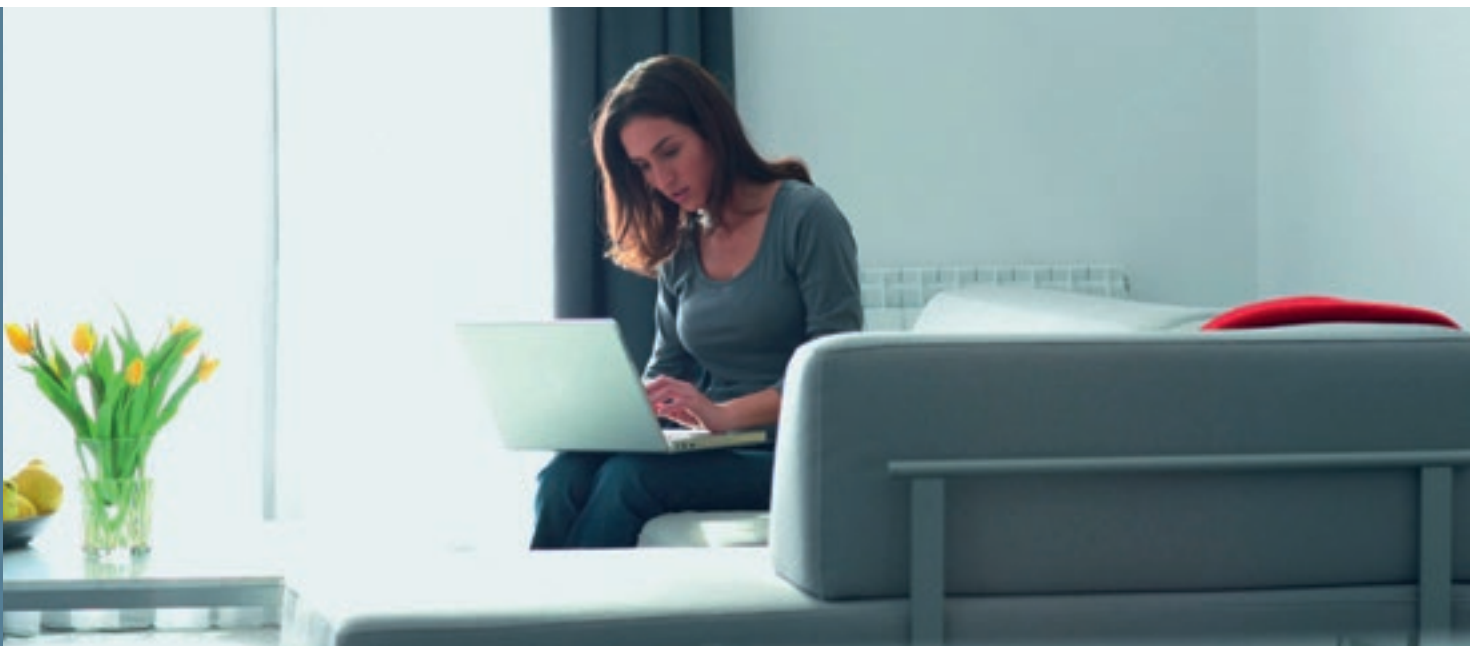

# The all-inclusive package from control to motor protection: “Plug & Play”!

*Air movement – at an all-inclusive price! Yet another of the major advantages of GreenTech EC technology from ebm-papst. Our EC products come with everything you may ever need: PID control amplifier, interference suppression filter, power filter, motor protection and even a power supply for external sensors. That’s how easy it is with “Plug & Play”: If you do an application check, you will soon see how many components are additionally required with conventional AC or rival products. By contrast, a GreenTech EC fan already contains all the necessary extras – as you can see in the list below.*

## **Example: The all-inclusive benefits of a GreenTech EC fan.**

Fewer additional peripherals, less installation work – and all the useful features already installed and fully checked: That’s how easy it is to put ebm-papst GreenTech EC technology to practical use.



Intelligent electronics – intelligent performance: Our EC products come with everything later may be needed.

1	<b>PID control amplifier</b>	✓
2	<b>Power factor controller/power filter</b>	✓
3	<b>Interference suppression filter</b>	✓
4	<b>Motor protection</b>	✓
5	<b>Sensor power supply</b>	✓
6	<b>Shielded wiring</b>	not necessary ✓
7	<b>RS485 MODBUS-RTU</b>	✓
8	<b>Excess temperature protection</b>	✓
9	<b>Motor current limitation</b>	✓
10	<b>Alarm relay</b>	✓
11	<b>Soft start</b>	✓
12	<b>Connection options</b>	✓

## **The features in detail:**

- 1 PID control amplifier:** A corresponding sensor with standard analogue output (0–10 V or 4–20 mA) is all that is required for pressure or temperature regulation. Set value, control range, direction of action and control parameters are all adjustable.
- 2 PFC/power filter** reduces circuit feedback. At rated power the power factor is typically greater than 0.9.
- The **interference suppression filter** reduces the emission of conducted and radiated interference voltages and guarantees immunity to interference in rough industrial environments.
- 4 Motor protection** prevents overloading of the motor in all operating condition.
- The **power supply** for external sensors is provided via the fan.
- The **integration of the commutation electronics into the motor** avoids the need for shielded wiring.
- The open protocol standard **RS485 MODBUS-RTU** provides numerous setting options for functions, parameter adjustment options and integration of the fan into higher-level systems.
- 8 Excess temperature protection** prevents damage to the motor and electronics in the event of overload.
- 9 Motor current limitation** provides additional safety.
- Any faults occurring are immediately signalled by the **integrated alarm relay**.
- A soft start function and **electronic power limitation on motor starting** ensure gentle fan start-up.
- 12 Numerous connection options**, e. g. for external sensors we provide many connection possibilities for maximum flexibility.

## Fewer types, simplified logistics: Start saving even before installation!

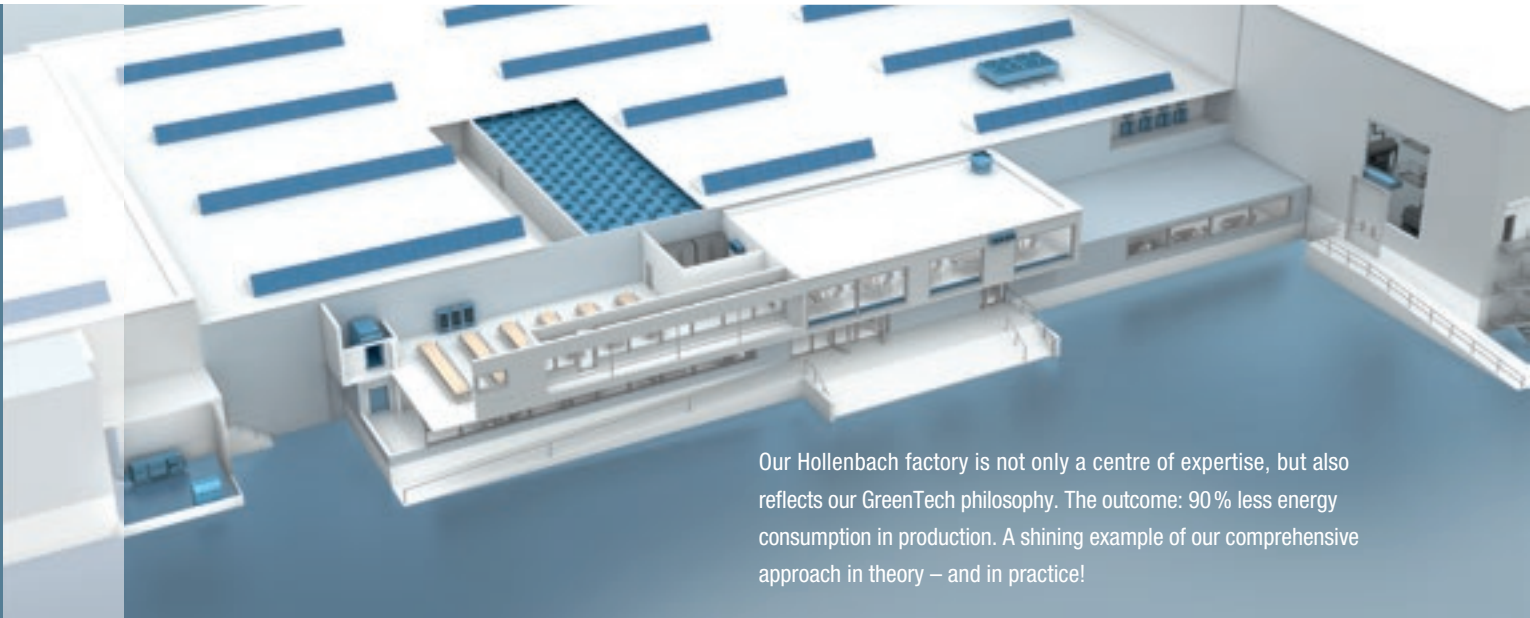

Our Hollenbach factory is not only a centre of expertise, but also reflects our GreenTech philosophy. The outcome: 90% less energy consumption in production. A shining example of our comprehensive approach in theory – and in practice!

*GreenTech EC technology – the ideal substitute for AC technology. In addition to being far superior in terms of energy efficiency, noise minimisation and intelligence, it helps to simplify logistics. Just a few GreenTech EC axial fans are enough to replace up to 8 different AC axial fans with different blade angles on a more or less 1-to-1 basis. This ensures the maximum possible application flexibility – all around the world. The combination of fewer types, simpler warehousing and less complicated logistics all adds up to a greatly reduced financial outlay.*

### One takes the place of many:

#### When using GreenTech EC instead of AC.

Assuming optimum efficiency and an ideal choice of motor size for the application concerned, it is always possible to replace 8 fans of AC type with just 4 GreenTech EC models. The graph says it all: 4 EC models are enough to cover the entire blue area, whereas – without additional speed control – AC can only be used on the black curves.

### Suitable for use worldwide.

ebm-papst GreenTech EC fans are designed for a wide input voltage range. Consequently the characteristic curve hardly changes over the entire voltage and frequency spectrum, thus ensuring that our fans can be used all over the world whatever the voltage and frequency.

- 3-phase, 200–240 VAC, 50/60 Hz
- 3-phase, 380–480 VAC, 50/60 Hz
- 1-phase, 200–277 VAC, 50/60 Hz
- 1-phase, 115 VAC, 50/60 Hz

Each can be regulated to the required operating point.

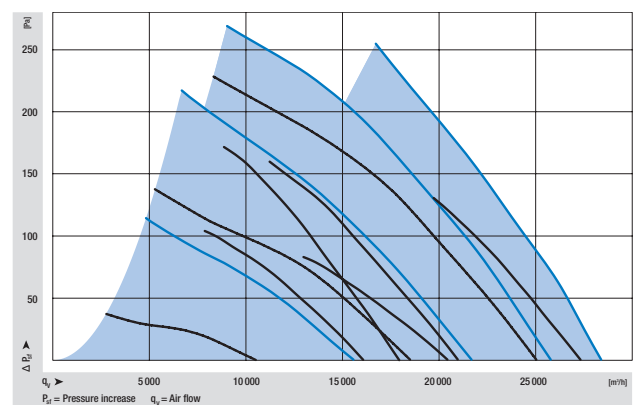

— AC with various blade angles  
— EC

# GreenTech innovations: That's where the future lies!

*The ErP directive for 2015 quite clearly shows: EC technology from ebm-papst is years ahead of its time. Not surprisingly, as we were one of the first technology companies to recognise the potential of electronic commutation and systematically promote its advancement. To stop now and rest on our laurels would not do justice to our claim to be the leading innovative company in the field of fans and drive systems. And so we continue to pursue our research and development work. We do not just concentrate on the actual motor, but rather look at every product as a whole with a view to exploiting all possible potential for increasing efficiency – whether this is to be found in materials, electronic control or aerodynamics. A few examples:*

## **We have not finished yet.**

Without doubt: Our EC technology forms the hub of GreenTech around which everything revolves. And we intend to keep it that way. Even so there is no let-up in our constant research and development activities – in all areas of fan and drive technology. Innovations which keep on setting new standards are the outcome.

## **Revolutionary materials – HyBlade® and RadiCal.**

The way in which innovative motor and ventilation technology can ideally complement one another is perfectly illustrated by our fans with a hybrid materialstructure: HyBlade® and RadiCal. A combination of metal and plastic elements in the axial and centrifugal impellers makes them particularly light and offers potential for optimum aerodynamic design, culminating in a previously unattained level of energy efficiency – in conjunction with near-silent running.

## **The future belongs to biomaterials.**

Increasing efficiency whilst conserving resources – the comprehensive GreenTech approach starts with the development and production of our motors and fans. We are already in the process of developing materials incorporating regenerative raw materials with a view to replacing certain oil-based plastics in the future. Good for the environment and a good selling point.

## **Intelligent electronics help to make savings.**

One of the greatest strengths of EC technology is the fact that it permits regulation based on demand. Optimum results can however only be achieved if this is put to the best possible use. Here again ebm-papst leads the way: Firstly by integrating a wide range of functions into all GreenTech motors and fans and secondly by providing numerous connections and interfaces offering virtually unlimited control and networking potential.

But that's a whole new story – starting on the next page ...



# Intelligent electronics with a wide range of functions: The systematic approach!

GreenTech EC fan networks are employed in refrigeration and air conditioning systems, for building ventilation, in clean rooms and many other areas of application. For communication with the bus systems, the ebm-papst product range can offer various interfaces and software solutions to suit each field and provide optimum support for setting-up and monitoring installations.

## Measurement, control, regulation, automation.

Intelligent control and regulation functions are – alongside outstanding energy efficiency – some of the great benefits offered by ebm-papst GreenTech EC technology. From simple read-out of the current speed to the configuration of a sensor control system, the electronics integrated into our GreenTech EC fans provide plenty of options for achieving the demand-based, efficient operation of installations.

Based on the type of use, application, working environment and equipment concerned, various concepts ensure reliable actuation with GreenTech EC fans. These include analogue actuation options such as 0–10 V and 4–20 mA for sensor connection and a set value generator connection. Digital control functions and complex regulation concepts can, however, also be implemented by way of a digital bus system (MODBUS-RTU). Remote interrogation of external sensors connected to our fans is a further possibility.

The next few pages outline the combination options available with our software and peripheral equipment packages, such as the *Bluetooth* wireless standard for setting and operating our fans, as well as the various communication standards.



## MODBUS-RTU – the reliable standard protocol

<b>Interface</b>	RS485
<b>Baud rate*</b>	19,200 bits/s
<b>Protocol frame*</b>	8E+1
<b>Data exchange</b>	To ebm-papst MODBUS-RTU parameter specification
<b>Number of nodes**</b>	up to 247
<b>Devices on BUS</b>	all MODBUS-RTU-compatible devices
<b>Fault detection</b>	CRC16
<b>Software support</b>	EC Control EC Clone Fan Control

\*Other values also possible as of ebm-papst MODBUS specification 4.0.

\*\*For installations with more than 31 fans use may have to be made of RS485 repeaters depending on the type of fan.

## GreenTech EC technology and MODBUS-RTU – the benefits:

- Open, globally recognised communication standard (non-proprietary)
- Suitable for integration into a central energy and data management system
- Interrogation of operating statuses
- Networking with other bus systems, e.g. via BAC-Net, KNX, LON Works and enOcean
- Remote interrogation and automation in conjunction with other MODBUS-RTU-compatible devices (actuators and sensors)
- Use of existing function libraries
- High system and transmission reliability

For further information on MODBUS-RTU, visit [www.modbus.org/tech.php](http://www.modbus.org/tech.php)



# Intelligent networking and reliable control: To keep everything in check.

There are hardly any fan applications in which the numerous communication options provided by our GreenTech EC technology do not work to your benefit. In the form of remote monitoring via internet, SMS, e-mail or Bluetooth for example. All the necessary information, from speed to motor temperature and operating or fault messages, is available at all times – and, if required, all around the world.

## Remote monitoring made easy.

With a modern IT infrastructure, the functions are monitored by way of MODBUS-RTU. The information can be processed and evaluated using MODBUS standard software, for example, or by means of ebm-papst EC Control or Fan Control or with customer software.

There are basically two remote monitoring options: One alternative is to use ebm-papst's own EC Control software on a host PC with an interface converter. The host PC can then be accessed by way of remote desktop software (e. g. VNC, Team Viewer). The other alternative is to use a laptop to access a PLC or a controller.

The following are some of the parameters available for remote energy utilisation optimisation, load management, preventive maintenance, control commands, fault rectification and re-programming:

- Operating hours
- Speed
- Current (DC link)
- Voltage (DC link)
- Power consumption (can be calculated from current input and voltage)
- Emergency operation function
- Temperature of motor
- Temperature of electronics
- Temperature of power section
- Mode of operation (control of temperature, pressure and air flow; actuator/controller; set value/actual value; cooling/heating)
- Operation and alarm display = alarm signal

It is also possible to interrogate external sensors connected to the terminal strip of the fans.

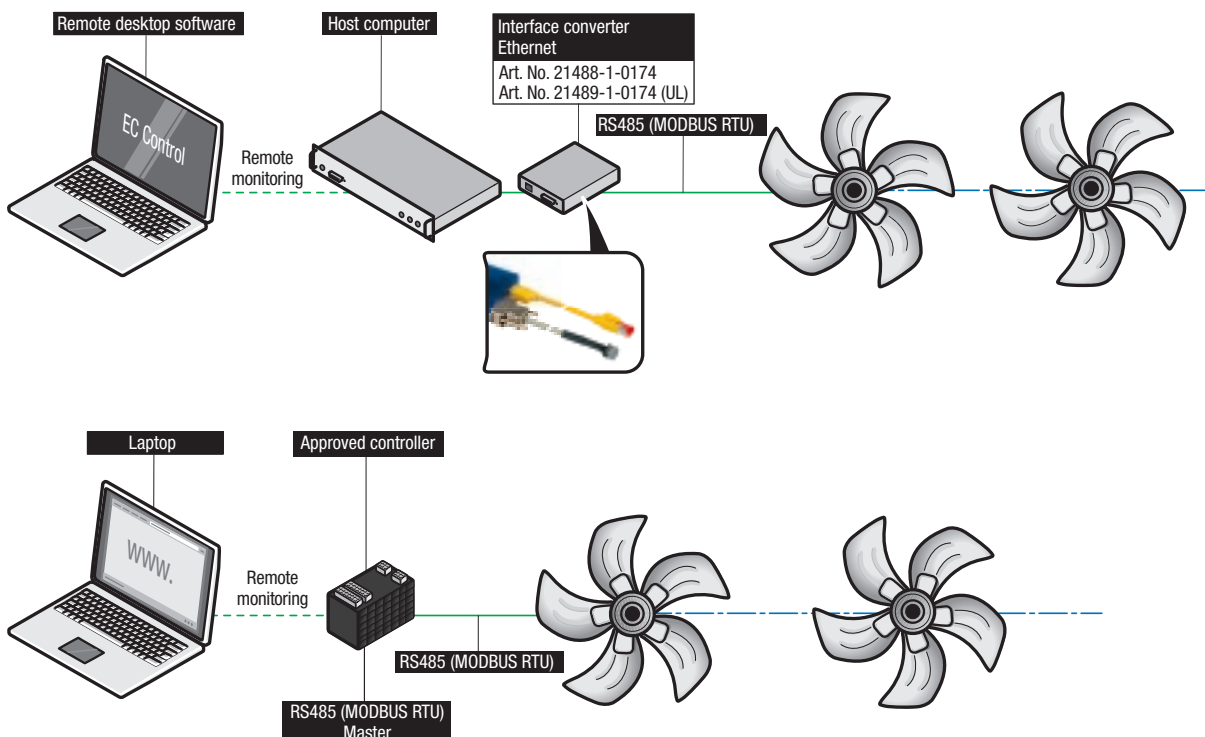

# Communication via MODBUS-RTU: The ideal connection!

Thanks to its open and simple protocol, MODBUS-RTU has become established as a worldwide standard for the control of actuators and sensors. We can offer a wide range of GreenTech EC fans and motors which support this interface as standard. Numerous programmable logic controllers also feature a MODBUS-RTU interface. This provides an extremely uncomplicated way of implementing complex automation tasks – typical applications include shopping centres, schools, office blocks, swimming baths, bakeries and butchers' shops. The diagram below shows how the individual components can be ideally linked.

### Three levels of communication.

MODBUS-RTU is the ideal basis for data transfer for incorporating EC technology into control and regulation processes. This example shows the form of networking which could be employed in a large building complex. The network hierarchy is arranged on three levels:

The **“coordinating level”** is the level on which all information is collated. The monitoring centre is the building control system where all data are recorded and analysed – for general management tasks and system optimisation. With the help of the stored data it is also possible to analyse usage patterns over a lengthy period and use this as a basis for planning the future utilisation of equipment.

The **“automation level”** contains the control centres for the various application areas: e.g. lights, window blinds, air handling units, condenser units etc. Each of these installations has its own control unit: PLC (programmable logic controller). The PLC is a popular type of controller programmed to suit the application concerned. Alternatively use can be made of application controllers, which are specially designed and programmed for a particular automation task.

Numerous different bus systems can be employed to link the coordinating and automation levels. The process data of the higher-ranking coordinating level, e.g. a BACnet system, are made available by way of the bus systems.

The **“field level”** is where the actual actuators operate – such as the ebm-papst GreenTech EC fans and motors. There are also numerous sensors for measuring the ambient temperature or the pressure in the coolant pipes for example.

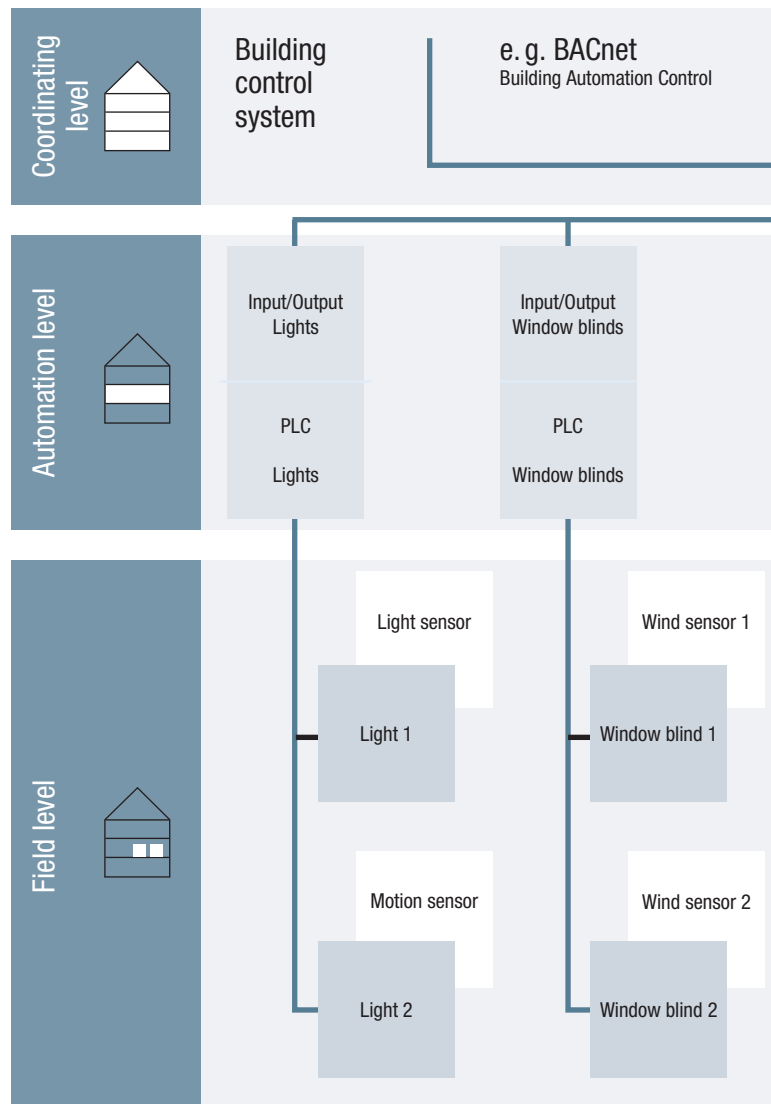

# ebm-papst approved controller: Just right.

*The controllers responsible for controlling a MODBUS-RTU system have to satisfy exacting demands: On the one hand, they have to master the control tasks associated with the application – which may vary considerably. At the same time they have to be familiar with all the functions used by the connected actuators to ensure optimum utilisation. There is no universal solution for complex automation tasks, but we work together with specialists in this field. Our ebm-papst approved controller range forms the perfect link between our products and those offered by the automation experts. We do not just sell fans, we help to provide the complete package.*

## **ebm-papst approved controllers.**

GreenTech EC technology offers a wide range of control, automation and monitoring options. Approved controllers make the best possible use of these and are available from our automation partners.

ebm-papst approved controllers are the perfect match for our EC fans. They can be divided into two groups: programmable logic controllers (PLC) and application controllers. Whereas a PLC is programmable, an application controller is pre-programmed and programmed for specific applications. We work with specialists for all types of system.

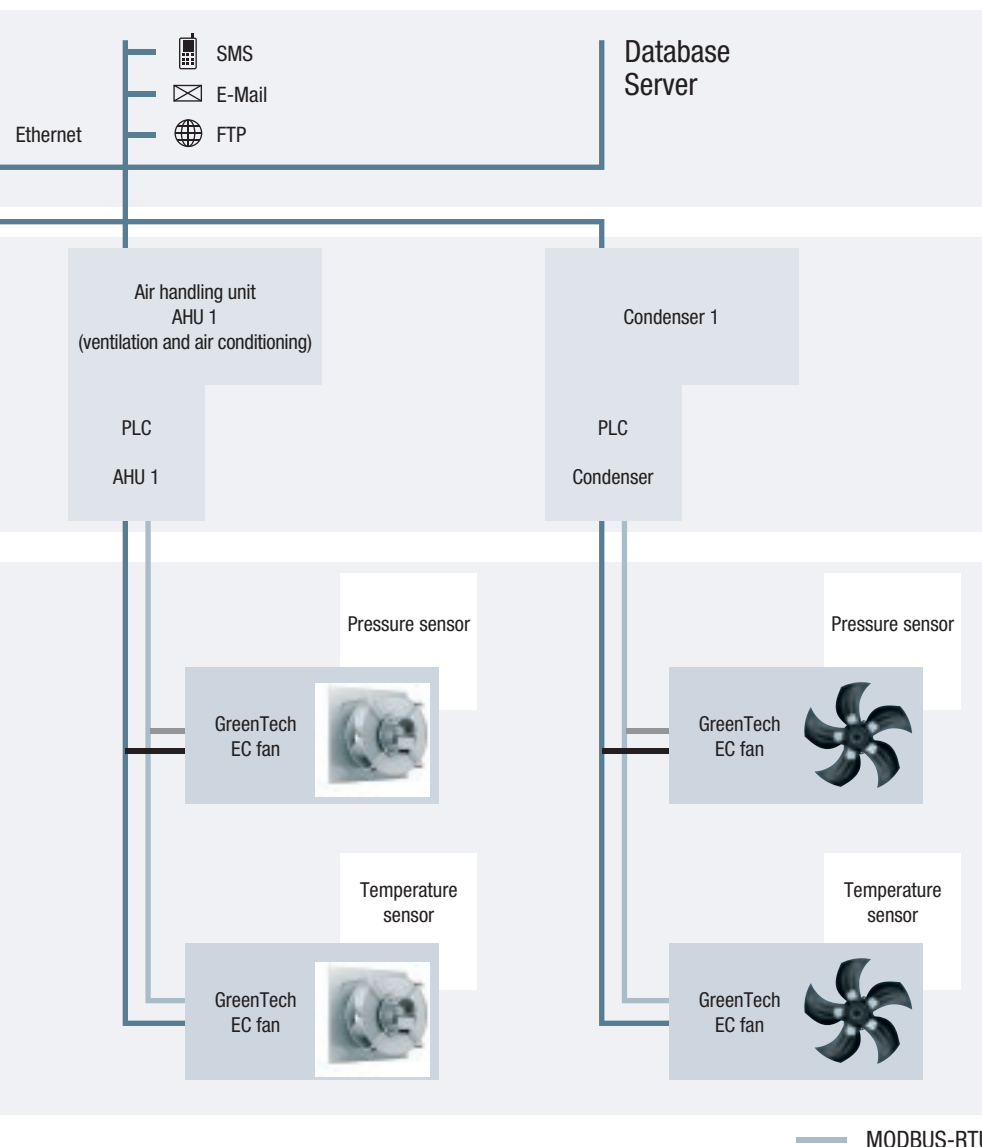

The advantages of ebm-papst approved controllers:

- Extremely simple programming through access to libraries\*
- Link with the modern IT world (iPad apps, SMS, e-mail, FTP or hardware such as touch panels, smartphones)
- Integrated file server, evaluation options using office applications
- Integrated web server, control with web browser possible
- Guaranteed tailor-made solutions

\* for PLC only

For detailed information on the ebm-papst approved controller range, visit

[www.ebmpapst.com/controller](http://www.ebmpapst.com/controller)

**approved controller  
for  
ebmpapst products**

# Software and interfaces at a glance: The right combination.

Which control software is suitable for which input device and what differences are there between the functions? This double sheet provides a clear overview for easy reference.

## What goes with what: Interfaces and protocols supported.

Software	EC Control (Page 22)	EC Clone (Page 24)	Fan Control (Page 25)	EC Controller (Page 32)
<b>Applications</b>	Service purposes and stationery system monitoring	Production, copying and archiving of settings	Service purposes and mobile use	Stand-alone control unit for refrigeration and air conditioning
<b>Hardware</b>	<b>PC/Laptop</b>	<b>PC/Laptop</b>	<b>PDA/Smartphone</b>	
Bluetooth adapter (Page 26)	●	●	●	
USB adapter (Page 28)	●	●		
Ethernet – RS485 interface converter (Page 30)	●	●		
RS485 MODBUS-RTU (Page 32)	●	●	●	●

Characteristic features of control software for PCs and PDAs	EC Control	Fan Control	EC Controller
Interrogation and modification of parameters of one fan	•	•	(•)
Modification of parameters for group/entire system	•	–	–
Group view/floors	•	(•)	–
Detailed fault history (with long software run time)	•	–	–
Mapping of system layout/room plan	•	–	–
Search for fan with unknown address	•	•	•
Graphical setting of parameters	–	•	–
E-mail in the event of faults	•	–	–
Multiple language support*	•	•	•
Support for RS485 ebmBUS	•	•	–
Support for RS485 MODBUS-RTU	•	•	•
Support for Ethernet and various sub-nets	•	–	–
Modulation level display on fan symbol	•	–	–
Display of information under fan symbol	•	–	–
Representation of the system in a tree structure	•	–	–
Support for multiple configurations in one installation	•	–	–
User manual (PDF)	• (DE/EN/FR/JA)	• (DE/EN)	• (DE/EN)
Timer	•	–	–
Integrated help system (English)	•	–	–
Extended functions for clean rooms**	•	–	–

Key:

- = Feature provided
- (•) = Partly/not fully available
- = Not provided

\*Supported languages vary depending on product

\*\*Please request white paper



# EC Control – our high-performance control program: Keeps everything in check!

*The ebm-papst control program EC Control provides detailed control and monitoring of fan groups in ebmBUS and MODBUS-RTU networks. There is nothing complicated about the multi-lingual, intuitive user interface in a familiar Windows® system environment: The positions of fans can easily be determined in the layout plan of the storey concerned for instance. So you can always keep an eye on all fans, even if there are thousands of them in a network. Version 2.0 saw the introduction of lots of new features such as extra languages, extended help functions, a set-up wizard and a revised fan setting dialogue arranged in self-explanatory categories. This makes setting up the system, the Ethernet/RS485 interface converter and the fan parameters easy and convenient.*

## **EC Control software for EC systems.**

EC control permits the visualisation and programming of ebmBUS and MODBUS-RTU fan networks and can be configured for USB, as well as serial and Ethernet interface converters. Starting with version 2.0, EC Control also supports the *Bluetooth* adapter. Several interface converters can be connected for shorter latency.

The software supports the maximum number of devices permitted by the bus system concerned (up to 7,905 fans with ebmBUS and 247 with MODBUS-RTU). This can however be extended by employing additional sub-net addressing. It is then possible to use each fan address not just once per system, but once per interface converter. As a result, up to 4 x 247 fans are then supported if using the MODBUS-RTU protocol and 4 x 7,905 fans with the ebmBUS protocol.

The variable EC Control user interface makes it easy to distinguish between the various interface converters if so required. It then just shows the entries of relevance to the particular system. Further functions include support for a second monitor, a management tree structure to enable specific fans to be located in complex systems and online help.

## **Functions:**

- Setting of more than 40 fan parameters e. g. mode of operation, set value and control parameters
- Changing of fan address (also using MODBUS 5.0 auto-addressing)
- Readout of fan parameters such as actual speed, serial number and production date
- Readout of fault status and fault memory
- Saving of various configurations as exportable and editable profile
- Monitoring of installations, including the possibility of reporting faults by e-mail
- Management of several systems within one program installation
- Support for Ethernet/RS485 interface converters as well as USB and *Bluetooth*/RS485
- Simultaneous monitoring of ebmBUS and MODBUS-RTU-based system components (requires several interface converters)
- Output of status messages via USB relay box (Art. no. 10450-1-0174) with the option of triggering external action, e. g. indicator lamp
- Monitoring of up to 4 x 247 fans with MODBUS-RTU systems and 4 x 7,905 fans with ebmBUS systems
- Extended export and import of attachments in CSV format with all the relevant information – also for exchange between operating systems with different language versions



USB relay box (Art. no. 10450-1-0174)  
for processing various fan status messages.

**System version:** EC Control 2.1

**Article number:** 25714-2-0199

**Scope of delivery:**

CD-ROM with

- Software in DE, EN, ES, FR, IT, NL, FI, PT-BR, JA, ZH (simplified/traditional), RU
- Operating instructions in DE, EN, JA, FR
- Application manual in DE, EN, JA, FR, RU
- Quick video guides

**System requirements:**

- Windows XP Service Pack 3, Windows 7 Service Pack 1 or Windows 8
- Approx. 60 MB available space on hard disk; extra space is required for the driver if using the USB relay box
- Monitor with a resolution of at least 1024 x 768 pixels and 16-bit colour depth
- CD-ROM drive (only required during installation)
- At least one of the following types of interface converter:
  - *Bluetooth* adapter (Art. no. 21501-1-0174)
  - USB (Art. no. 21490-1-0174)
  - Ethernet (Art. no. 21488-1-0174/21489-1-0174 (UL))

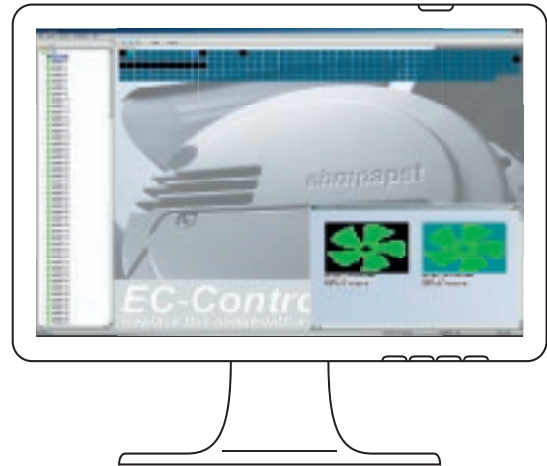

### EC Clone commissioning software for Windows.

EC Clone provides efficient programming for fans manufactured in small series with customer-specific configuration. Following readout of the fan configuration from the fan or from a file, the configuration is transmitted to other fans with or without alteration of the device address of the target fan. EC Clone is also capable of identifying fans with an unknown fan address. The touch screen-friendly design of the software means there is no need for a mouse or keypad at the workplace.

### Functions:

The software enables the following parameters to be copied onto other fans:

- Mode of operation (speed control/sensor control/PWM control)
- Saving of set value in EEPROM
- Set value source (bus versus analogue input)
- Controller function (heating/cooling)
- Default set value (for both parameter sets\*\*)
- P, I, D controller (with D = 0 as fixed setting)
- Maximum speed
- Min./Max. PWM
- Set value 0 and 1 (active with digital interpretation of analogue input)\*
- Reduction factor\*
- Sensor parameters
- Run-up and run-down time
- Control function source (bus versus external terminal/switch\*\*)
- Output function of analogue output\*\*
- Output curve of analogue output\*\*
- Emergency operation function/cable break detection\*\*
- Parameter set source/parameter set\*\*
- Motor stop enable\*\*
- Analogue input curves\*\*
- Direction of rotation source\*\*
- Preferred direction of rotation\*\*/direction of rotation\*
- Sensor actual value source\*\*
- Motor derating parameter\*\* (as of MODBUS 5.00)
- Limit speed for run monitoring\*\*
- Communication parameters\*\* (baud rate and parity)
- Shake-loose function\*\* (as of MODBUS 5.00)
- Relay drop-out delay\*\* (as of MODBUS 5.00)

\*ebmBUS

\*\*MODBUS-RTU

**Program version:** EC Clone 1.10

**Article number:** 25716-2-0199

### Scope of delivery:

CD-ROM with

- Manual (EN) in PDF format
- Installation program
- Quick video guide
- Driver for USB interface converter
- Adobe Reader

**Language:** EN

### System requirements:

- Windows XP Service Pack 3, Windows 7 Service Pack 1 or Windows 8
- Approx. 20 MB space on hard disk
- Monitor with a resolution of at least 1024 x 768 pixels
- One of the following types of interface converter:
  - USB (Art. no. 21490-1-0174)
  - *Bluetooth* adapter (Art. no. 21503-1-0174 and 21501-1-0174)
  - Ethernet (Art. no. 21488-1-0174/21489-1-0174)





# Control software for smartphones: The perfect mobile solution!

*ebm-papst fans equipped with an RS485 interface can communicate with smartphones/PDAs by way of the ebm-papst Bluetooth adapter for wireless programming and monitoring. Diagnosis is also possible in the event of faults. For this purpose, the Bluetooth adapter creates a bidirectional link between RS485 units and Bluetooth compatible computers, PDAs and smartphones. The adapter is compatible with the Fan Control, EC Clone and EC Control 2.1 programs.*

## Fan Control software for smartphone/PDA.

Fan Control can be used with both ebmBUS and MODBUS-RTU devices. For MODBUS-RTU use, the software is provided with graphical and numeric setting options and permits internal fan back-up of the current settings as well as the storage of two parameter sets, e.g. for daytime and night-time operation. The emergency operation function permits the specification of a set value which the fan adopts automatically if no bus communication has taken place for a set period of time.

## Functions:

- Monitoring of fan groups
- Status display for connected fans
- Programming of individual fans, e.g. alteration of fan address
- Alteration of fan operating mode (speed control/PWM control/sensor control)
- Alteration of set values (speed, direction of rotation etc.)
- Setting of control parameters (also graphically)
- Alteration of min/max values
- Graphical setting of min and max PWM and set value, as well as control range for sensor control (P controller only)
- Readout of fault status
- Search for unknown device addresses
- Setting of sensor characteristic for sensor control
- Setting of run-up and run-down ramp (“soft start”)
- Readout of a wide range of fan parameters

## MODBUS-RTU only:

- Graphical setting of characteristic curve of 0–10 V analogue input, thus even permitting implementation of “off” at 10 V and “maximum modulation level” at 1 V
- Resetting of fan to factory settings
- Direction reversal and 2-sensor control with MODBUS-RTU protocol version

**System version:** Fan Control 3.2

**Article number:** 25713-2-0199

## Scope of delivery:

CD-ROM with

- Manual (DE and EN) in PDF format
- Installation program (for all languages)
- Video set-up guide for *Bluetooth* connection

**Languages:** DE, EN, ES, FR, IT, NL, FI, JA, ZH (simplified/traditional), RU

## System requirements:

- ebm-papst *Bluetooth* adapter (Art. no. 21501-1-0174/21503-1-0174)
- Smartphone/PDA with min. 240 x 320 pixel resolution
- Windows Mobile 5 for Pocket PC or
- Windows Mobile 5 Phone Edition or
- Windows Mobile 6 Classic or
- Windows Mobile 6/6.1 Premium

A constantly updated list of compatible devices can be found at [www.ebmpapst.com/downloads](http://www.ebmpapst.com/downloads)



# Interface adapter *Bluetooth* RS485.



*ebm-papst fans equipped with an RS485 interface can communicate with smartphones/PDAs by way of the ebm-papst Bluetooth adapter for wireless programming and monitoring. Diagnosis is also possible in the event of faults. For this purpose, the Bluetooth adapter creates a bidirectional link between RS485 units and Bluetooth compatible computers, PDAs and smartphones. The adapter is compatible with the Fan Control, EC Clone and EC Control 2.1 programs.*



## Nominal data

Type		21503-1-0174
Power supply	VDC reversible	15–28
Integrated Li-IO battery	VDC/mAh	3.7/2200
Transmission power	mW	1 (Class II)
Range (depending on ambient conditions)	m	10–20
Dimensions	mm	120 x 65 x 40
Battery operation	h	>24

Operating mode:	RS485, 2-wire operation without echo, automatic switching between transmit and receive
RS485 connection:	Molex Micro-Fit 4-pole socket (matching connector: Molex, Art. no. 43025-0400 with 43030-0001)
Frequency band:	ISM band (2402–2480 MHz)
Status display:	By way of 3 LEDs <ul style="list-style-type: none"> <li>– Duo-LED green (top): Voltage OK, device switched on</li> <li>– Green/yellow flashing (<i>Bluetooth</i> link established)</li> <li>– Red (centre): Tx, data communication PDA/smartphone → fan</li> <li>– Red (bottom): Rx, data communication Fan → PDA/smartphone</li> </ul>
Housing:	Plastic housing
Type of protection:	IP 20
Scope of delivery:	<ul style="list-style-type: none"> <li>– <i>Bluetooth</i> adapter and 4-wire connecting cable with corresponding Molex connector and core-end sleeves</li> <li>– Integrated battery</li> <li>– 3.7 V plug-in power supply (for worldwide use) for battery charging even without fan connection</li> <li>– Product description</li> </ul>

**Connection of *Bluetooth* adapter based on the example of a MODBUS-RTU-compatible fan**

The *Bluetooth* adapter is connected directly to the fan. The fan voltage of 15 or 20 V is used to supply the adapter.

**Note:** Voltage reversal does not represent a problem for the *Bluetooth* adapter.

The *Bluetooth* adapter operates on the same licence-free 2.4 GHz frequency band as wireless LAN networks. The frequency hopping method used here guarantees interference immunity.

**Note:** Just one single *Bluetooth* adapter is required for communication with any size of system.

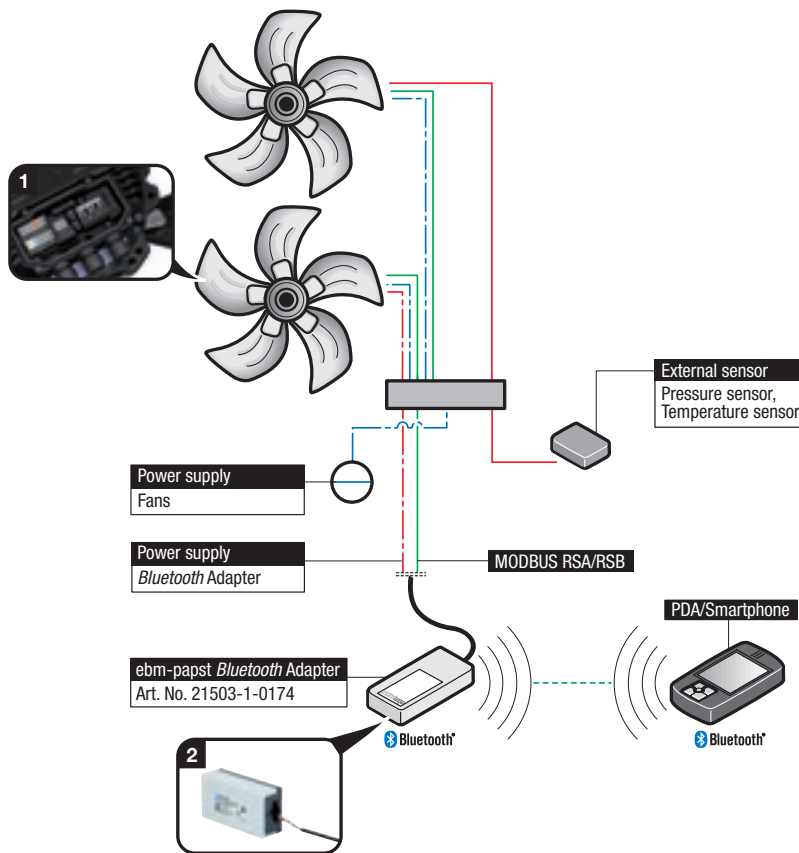

**1 Example of fan terminal assignment**

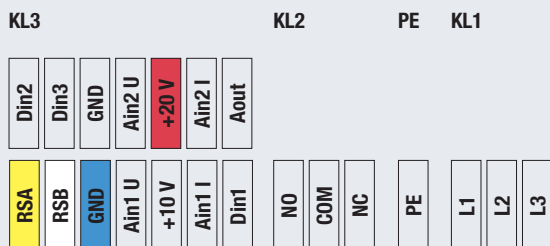

**2 Bluetooth adapter connection**

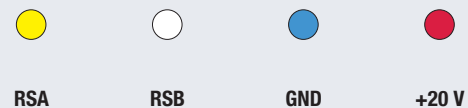

# USB Adapter RS485.



The ebm-papst USB RS485 adapter is used to connect RS485 devices to a PC. ebm-papst EC Control software as of version 2.0 is required for this purpose. The software also contains the USB drivers needed for operation of the adapter.

## Nominal data

Typ		21490-1-0174
Power supply	VDC	5 (via USB)
Current supply	mA	100 (via USB)
Dimensions	mm	56.0 x 31.2 x 24.5

Operating mode:	RS485, 2-wire operation without echo, internal termination with terminating resistor (pre-configured)
RS485 connection:	<ul style="list-style-type: none"> <li>– 2-wire</li> <li>– Max. cable length 1,200 m (9,600 bits/s), 1,000 m (19,200 bits/s)</li> </ul>
Data rate:	Up to 3 Mbits/s
Insulation:	2,500 V (overvoltage protection)
Status display:	Via LED <ul style="list-style-type: none"> <li>– Green: Rx, receive</li> <li>– Red: Tx, transmit</li> <li>– Yellow: Power ON</li> </ul>
Housing:	Plastic housing
Type of protection:	IP 10
Scope of delivery:	<ul style="list-style-type: none"> <li>– Adapter</li> <li>– Plug-in screw terminal</li> <li>– USB cable</li> </ul>

**Connection of USB RS485 adapter based on the example of a MODBUS-RTU-compatible fan.**

The device is connected by means of the USB connecting cable provided to a USB port of the PC. The yellow LED lights after connection.

**Note:** Install the USB drivers prior to connection to the USB port. The drivers are included with the EC Control (Art. no. 25714-2-0199) and EC Clone (Art. no. 25716-2-0199) software.

**Connection to RS485 bus:** Connect the A and B cables of the RS485 bus to the screw terminal and insert this in the adapter.

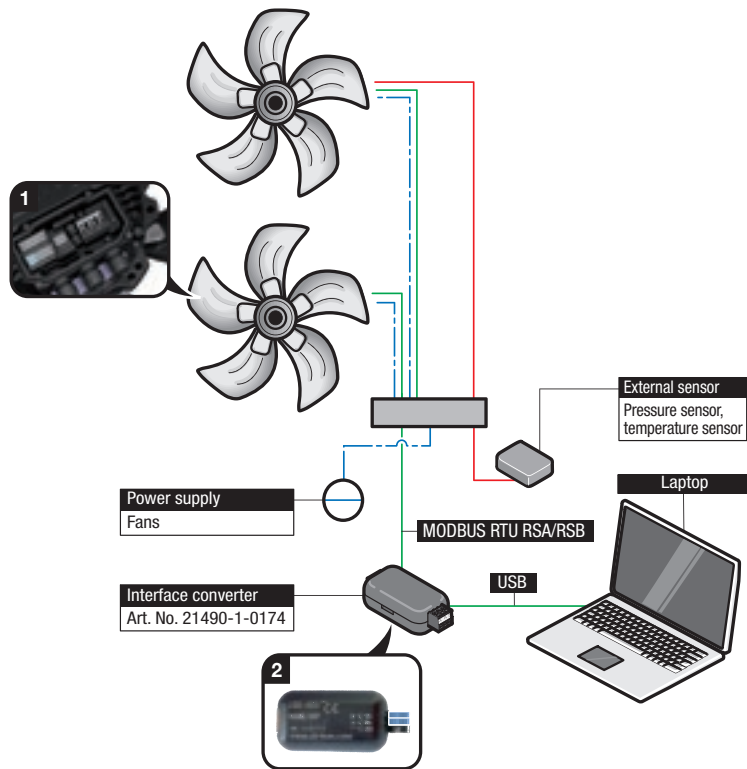

**1 Example of fan terminal assignment**

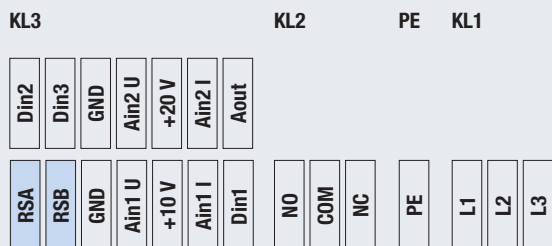

**2 Interface converter connection**

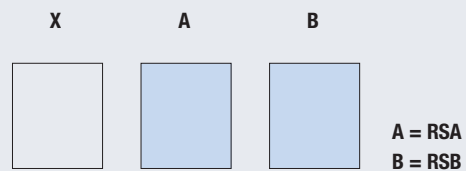

# Ethernet interface converter RS485.



Interface converter for bidirectional connection of RS485 units and Ethernet-compatible PCs or Notebooks using EC Control (Art. no. 25714-2-0199) or EC Clone (Art. no. 25716-2-0199) software.

## Nominal data

Nominal voltage (plug-in power supply provided)	VAC	100–240
Power supply	VDC	12–48
Current input	mA	85
Frequency (plug-in power supply provided)	Hz	50/60
Ambient temperature (arranged in series)	°C	0 ... +50
Ambient temperature (not arranged in series)	°C	0 ... +60
Dimensions	mm	105 x 75 x 22

Operating mode:	RS485, 2-wire operation without echo, automatic switching between transmit and receive
Safety:	Electrical isolation between Ethernet and RS485
Electrical isolation:	min. 500 V
Ethernet connection:	8-pole RJ45 socket 10/100 Mbit autosensing
RS485 connection:	9-pin SUB-D connector
Protocols used:	– TCP – Telnet (for configuration only)
Status display:	By way of LEDs – Green (left): Power supply – Green (right): Data communication – Red: Fault
Housing:	Plastic housing
Type of protection:	IP 10
Installation:	Standard rail mounting as per DIN EN 50022-35
Scope of delivery:	– Interface converter – Plug-in power supply – RS485 cable D-Sub to screw terminal – Network cable (crossover, Cat 5) – Product description DE and EN

**Connection of interface converter (Ethernet) based on the example of a MODBUS-RTU-compatible fan.**

The Ethernet interface converter is used to incorporate bus-compatible EC fans into existing computer networks. This permits greater flexibility with regard to the locations of the control centre and fans. Apart from a power supply, all that is required is a fixed IP address

which can easily be issued by means of the EC Control software. The use of several Ethernet interface converters is no problem. It is then possible to split up larger installations to shorten latency for example.

**Note on large installations:** As of 31 fans an additional repeater is required, to which a further 31 fans can be connected.

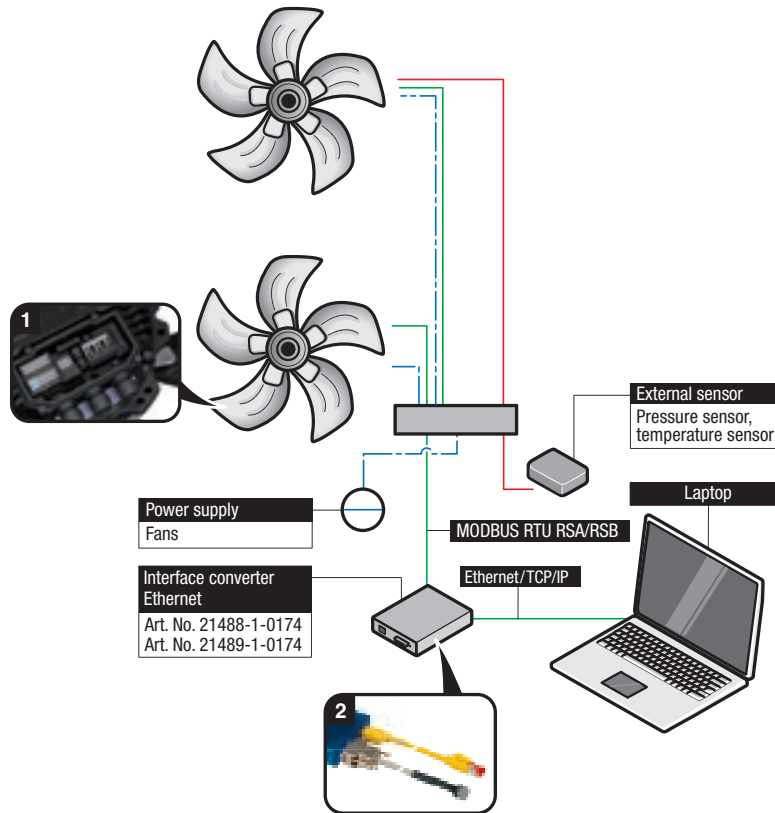

**1 Example of fan terminal assignment**

KL3							KL2				PE	KL1		
Din2	Din3	GND	Ain2 U	+20 V	Ain2 I	Aout								
RSA	RSB	GND	Ain1 U	+10 V	Ain1 I	Din1	NO	COM	NC	PE	L1	L2	L3	

**2 Interface converter connection**

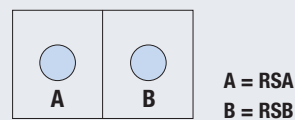

# EC controller.



Stand-alone control unit for refrigeration and air conditioning applications in conjunction with the corresponding sensors. *ebm-papst* fans with the appropriate input can be actuated by way of the controlled 0–10 VDC output or the RS485-MODBUS-RTU link. The features include multi-functional pressure and temperature regulation as well as the display and input of various parameters. The integrated LCD ensures ease of operation over several levels.

## Nominal data

Type		CCC000-AD06-02
Nominal voltage	V	1~200–480
Frequency	Hz	50/60
Power consumption	W	15
Sensor power supply	VDC	24
Output current	mA	120
Perm. ambient temperature	°C	0 ... +60
Perm. storage temperature	°C	–20 ... +60
Dimensions	mm	200 x 167 x 76

Inputs/outputs:	<ul style="list-style-type: none"> <li>– 24 V power supply for sensors</li> <li>– Analogue inputs for connection of up to 2 sensors per type</li> <li>– 4 digital inputs</li> <li>– 2 programmable relay outputs, voltage output 0–10 V</li> <li>– RS485 MODBUS RTU</li> </ul>
Applications:	<ul style="list-style-type: none"> <li>– Standard temperature regulation</li> <li>– Pressure control for ventilation systems, condensers, 2-circuit condensers</li> <li>– Pressure control with outside temperature compensation</li> </ul> <p>These applications are the factory default settings. Other applications can be programmed individually</p>
Sensors:	<ul style="list-style-type: none"> <li>– Temperature sensor KTY 10-6 (R25 = 2 kΩ), NTC 103AT (R25 = 10 kΩ)</li> <li>– Pressure sensor 0 ... 100/200/500/1000 Pa (output 0–10 V), 0 ... 30 bar (output 4–20 mA)</li> <li>– <i>ebm-papst</i> temperature sensors, Art. no. 50003-1-0174 and 50005-1-0174</li> <li>– Other sensors can be programmed individually</li> </ul>
Menu languages:	DE, SV, DA, EN (factory setting)
Housing:	Plastic housing
Standard conformity:	CE
Type of protection:	IP 54 (as per DIN EN 60529)
EMC:	As per EN 61000-6-3 and EN 61000-6-2
Installation:	Vertical wall mounting not permitted. Exposure to direct sunlight and installation on a vibrating surface are not permissible. Electrical connection by way of terminal strip



**Connection of EC controller based on the example of a MODBUS-RTU-compatible fan.**

The EC controller operates in combination with external sensors as a stand-alone control unit for fan networks. Factory default applications make commissioning easy – there is no need for connection of a

computer or other software-supported input devices. Integrated keypad control with an LCD is available for the programming of new applications and for monitoring.

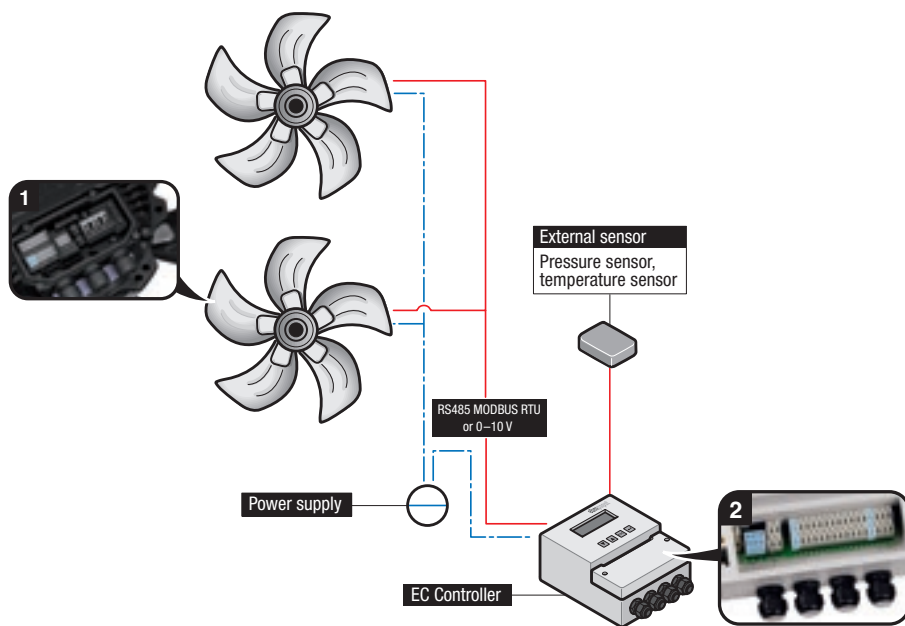

**1 Example of fan terminal assignment**

KL3			KL2			PE	KL1		
Din2	Din3	GND	Ain2 U	+20 V	Ain2 I	Aout			
RSA	RSB	GND	Ain1 U	+10 V	Ain1 I	Din1	NO	COM	NC
							PE	L1	L2
								L3	

**2 Example of EC controller terminal assignment**

KL1			KL2			KL3		
1	2	3	Relais 1	Relais 2	GND	GND	GND	GND
L1	N/L2	PE	Relais 1	Relais 2	Temp	Temp	+24 V	+24 V
					Temp	Temp	0-10 V E1	0-10 V E2
					Temp	Temp	0-10 V A1	0-10 V A2
					Temp	Temp	GND	D1
					Temp	Temp	GND	D2
					Temp	Temp	GND	D3
					Temp	Temp	GND	D4
					Temp	Temp	RSB	RSA
					Temp	Temp	RSB	RSA
					Temp	Temp	GND	GND
					Temp	Temp	GND	GND

# Pressure controller with integrated pressure sensor.



## Nominal data

Type		CCC 000-AC04 -01
Nominal voltage range	VAC	1~100–277
Frequency	Hz	50/60
Nominal voltage, alternative	VDC (50 mA)	20
Pressure control range	PA	50–500
Perm. ambient temperature	°C	–25 ... +60

Functions:	<ul style="list-style-type: none"><li>– Integrated PID controller</li><li>– Day/night/linear preset target value</li><li>– Integrated set value potentiometers for day and night</li><li>– External preset target value with potentiometer</li></ul>
Pressure sensor:	<ul style="list-style-type: none"><li>– 0–500 Pa</li><li>– Burst pressure 200 mbar</li><li>– For non-corrosive gaseous media</li></ul>
Type of protection:	IP 55
Inlet nozzles:	Suitable inlet nozzles for determining air flow can be found in our product documentation

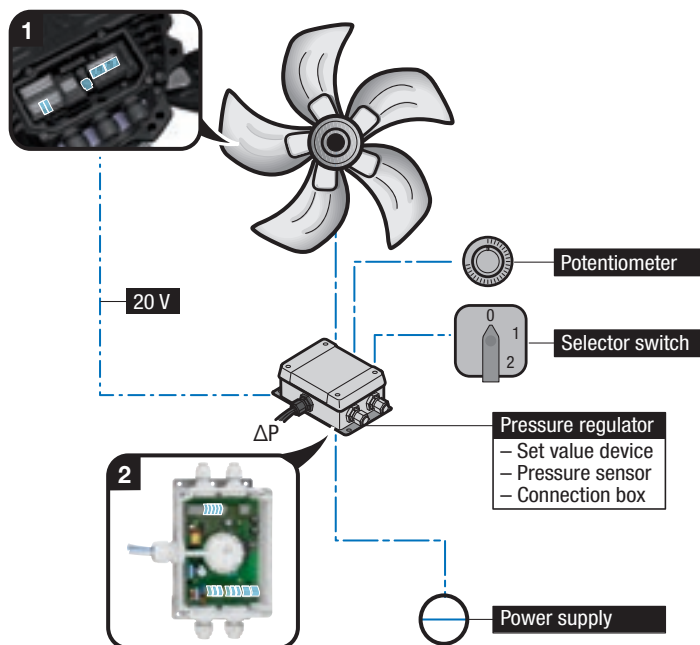

**1** Example of fan terminal assignment



**2** Example of terminal assignment for pressure controller with potentiometer

Mains connection



Control connection



# Differential pressure controller with integrated pressure sensor.



## Nominal data

Type		DPC200-EP50	DPC200-EP500	DPC200-EP1000	DPC200-EP2000	DPC200-EP4000
Nominal voltage	VDC (10 mA)	10 ... 30	10 ... 30	10 ... 30	10 ... 30	10 ... 30
Current input at 10 VDC	mA	7	7	7	7	7
Current input, alternative at 24 VDC	mA	12	12	12	12	12
Measuring ranges available	Pa	0 ... 50	0 ... 500	0 ... 1,000	0 ... 2,000	0 ... 4,000
Perm. ambient temperature	°C	0 ... +50	0 ... +50	0 ... +50	0 ... +50	0 ... +50
Weight	approx. g	90	90	90	90	90

### Functions:

- Selection of control or measurement mode
- Analogue output 0 ... 10 V, with adjustable limitation in control mode
- 2 set values can be set in the device
- PI algorithm with separate input of P and I parameters and control response as for ebm-papst products
- Switchable measurement quantities (differential pressure or air flow)
- Switchable units (metric or imperial)
- “Standard” or “Inverse” control response
- Air flow calculation following input of k-factor

### Pressure sensor:

- For non-corrosive gaseous media
- Smallest span 0 ... 50 Pa
- Largest span 0 ... 6,000 Pa
- Overload safety 0.2 bar
- Cable entry M16 x 1.5 screw terminals

### Type of protection:

IP 54

### Inlet nozzles:

Suitable inlet nozzles for determining air flow can be found in our product documentation

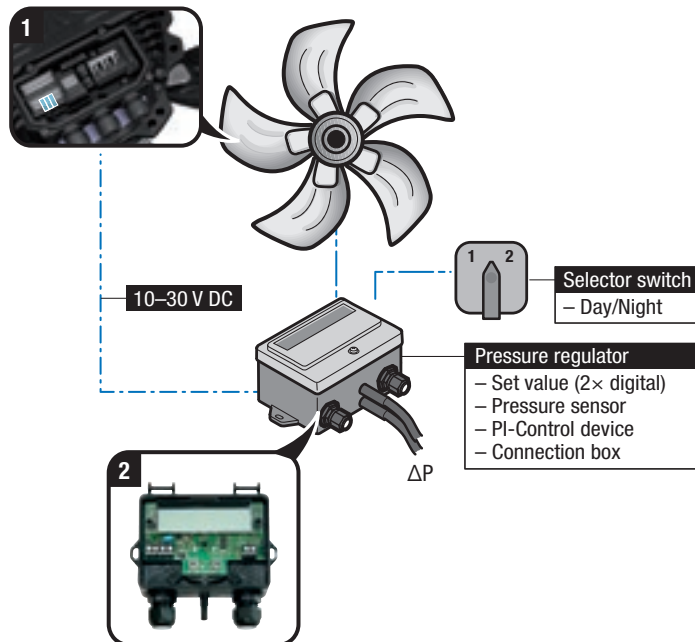

### 1 Example of fan terminal assignment

KL3							KL2			PE	KL1	
Din2	Din3	GND	Ain2 U	+20 V	Ain2 I	Aout						
RSA	RSB	GND	Ain1 U	+10 V	Ain1 I	Din1	NO	COM	NC	PE	L1	N

### 2 Example terminal assignment for differential pressure regulator

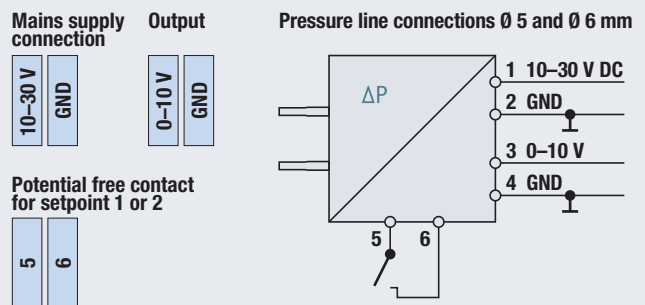

# Pressure sensor for pressure-regulated speed control.



## Nominal data

Type		Ⓐ 40100-4-7380	Ⓑ 40101-4-7380
Nominal voltage	VDC	10	10
Max. input current	mA	1	1
Adjustment range Cut-off	bar	4 ... 12,5	10 ... 21
Factory setting Cut-off	bar	7.8	15.5
Test pressure	bar	30	36
Max. operating pressure	bar	27	32
Max. media temperature	°C	70	70
Perm. ambient temperature	°C	-20 ... +65	-20 ... +65
Weight	g	125	125

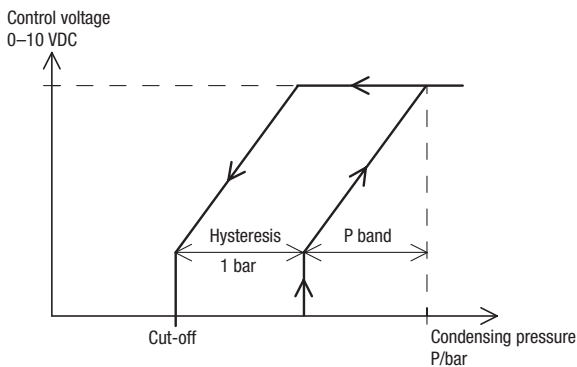

Material:	Housing made of PA, brass pressure connection
Type of protection:	IP 65 as per EN 60529 / IEC 529
Refrigerant:	Suitable for standard refrigerants ( R134A; R407C, R404A, R507)
Installation:	Simple installation via pressure connection with 7/16" -20 UNF internal thread with Schrader valve opener
Power supply:	Above 10 VDC
Speed setting:	0-10 VDC actuating output signal for pressure-dependent speed setting of fan
Delivery:	Individual pack

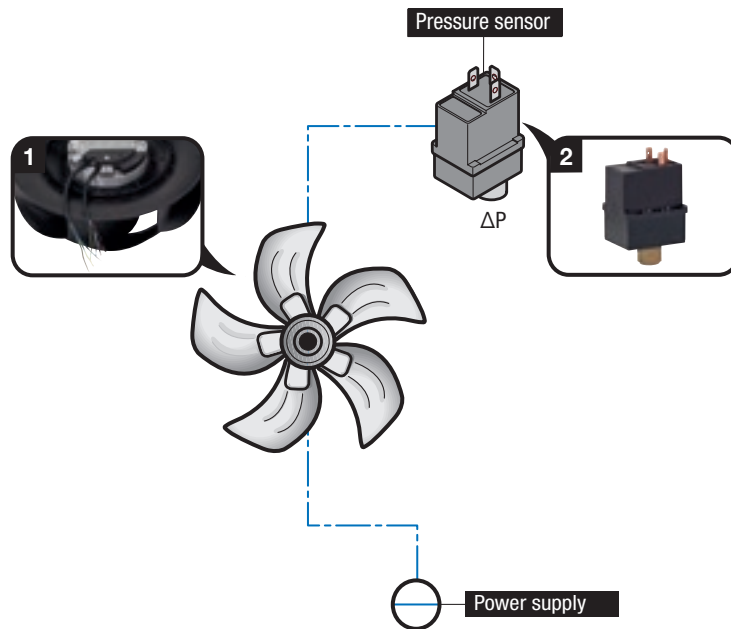

### 1 Fan connection example

#### Control

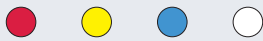

+10 V 0–10 VDC GND Tacho

#### Power



L N PE

### 2 Pressure sensor connector assignment

Signal 0–10 V



GND



10 V

Connection line available as accessory.

# Temperature sensors/control modules.



## Nominal data

Type		Ⓐ 50002-1-0174	Ⓑ 50003-1-0174	Ⓒ 50005-1-0174
Nominal voltage	VDC	18–60	18–60	15–30
Current input	mA	10	10	10
Output voltage	VDC	2–10	0–10	0–10
Output current	mA	0.1	0.1	1.0
Output impedance	kΩ	6.8	6.8	1.1
Temperature control range	°C	+30 ... +55	+10 ... +45	–20 ... +80
Weight	g	2	2	2

### Ⓐ Ⓑ Output voltage as a function of temperature:

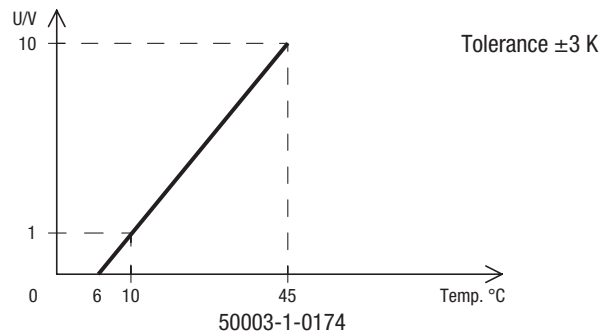
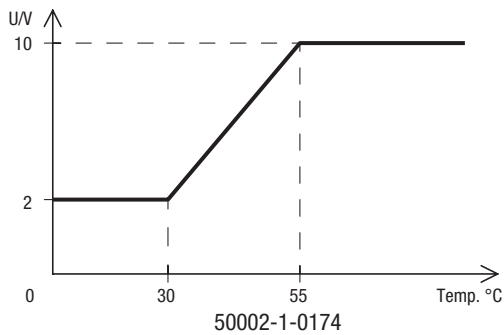

### Ⓒ Output voltage as a function of temperature:

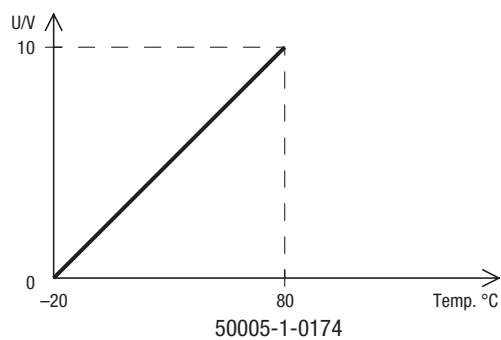

Tolerance ±3 K



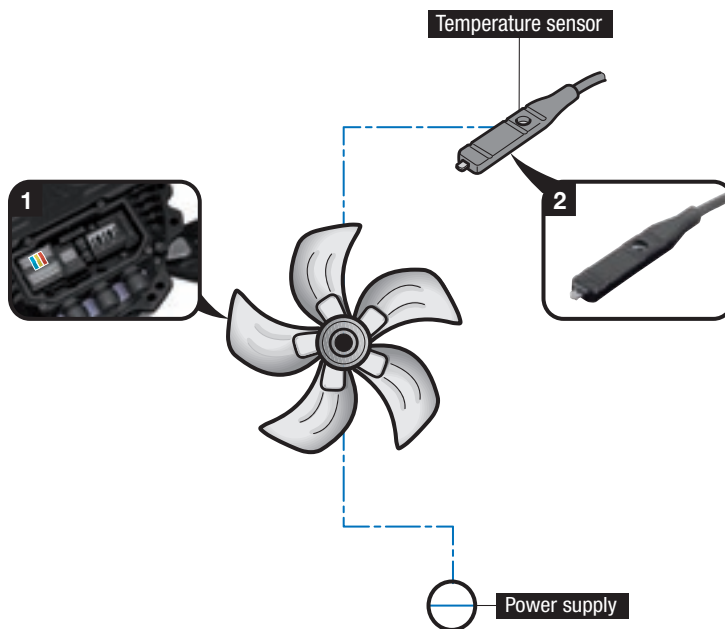

### 1 Example of fan terminal assignment

KL3							KL2			PE	KL1		
Din2	Din3	GND	Ain2 U	+20 V	Ain2 I	Aout	NO	COM	NC	PE	L1	L2	L3
RSA	RSB	GND	Ain1 U	+10 V	Ain1 I	Din1							

### 2 Temperature sensor cable assignment

	●	●	●
Ⓐ	18–60 VDC	0–10 VDC	GND
Ⓑ	18–60 VDC	0–10 VDC	GND
Ⓒ	15–30 VDC	0–10 VDC	GND

# Temperature sensors/control modules.



## Nominal data

Type		Ⓐ 50010-1-0174	Ⓑ 50011-1-0174
Nominal voltage	VDC	10–12	10–12
Input current	mA	1	1
PWM	VDC	min. 9.3	min. 9.3
Output current	mA	0.1	0.1
Output impedance	kΩ	1.1	1.1
Temperature control range	°C	+10 ... +45	+30 ... +55
Weight	g	2	2

### Ⓐ Output curve

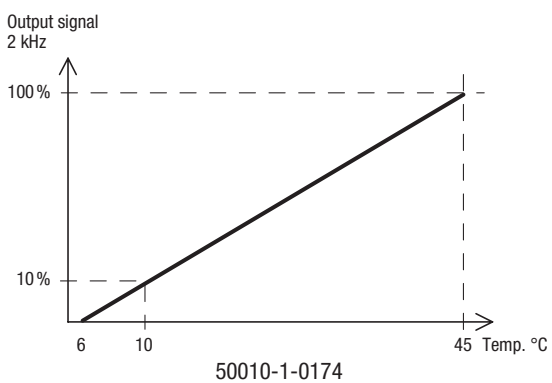

### Ⓑ Output curve

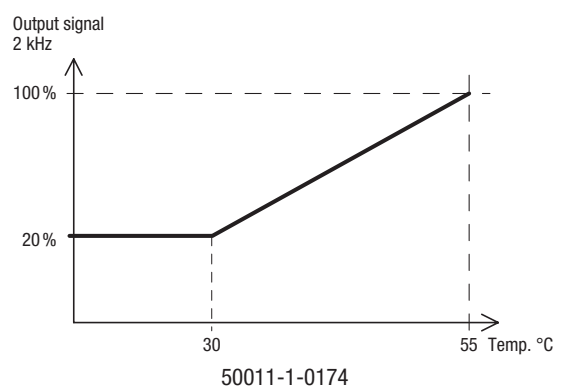

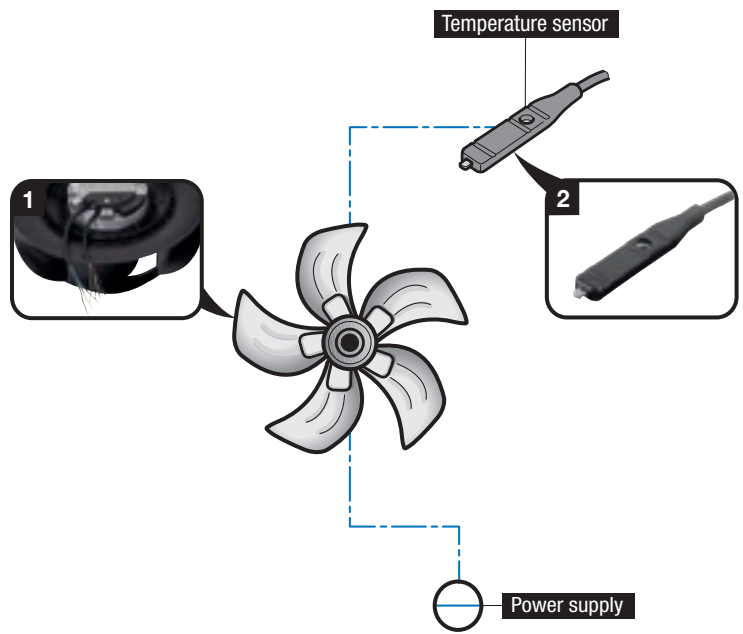

**1 Fan connection example**

**Control**

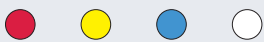

**+10 V 0-10 V GND Tacho**

**Power**



**L N PE**

**2 Temperature sensor cable assignment**



**+10 V 0-10 V GND**

We hope this brochure has given you a detailed insight into the full spectrum of our innovative GreenTech EC technology – right through from the theoretical principles to practical examples and the intelligent networking of complex systems. Please do not hesitate to contact us if you have any further questions on specific applications. Our specialists are always ready to help.

**ebm-papst**  
**Mulfingen GmbH & Co. KG**

Bachmühle 2  
74673 Mulfingen  
Germany  
Phone +49 7938 81-0  
Fax +49 7938 81-110  
[info1@de.ebmpapst.com](mailto:info1@de.ebmpapst.com)

**ebmpapst**

The engineer's choice