

Special-Sensors for Automation



Flow Sensors

Contents

Technique and application for flow sensors

Technique and application for flow sensors, amplifiers and compact models	1.03 - 1.07
Terminology / Setting instructions	1.08 - 1.09
Technique and application flow sensors inline-digital display	1.10
Ex area certification, valid standards	1.11 - 1.12

Flow sensors Series 400 / Series 500

Probe Series ST / STK.	1.14 - 1.17
Probe high temperature 120 °C Series ST.	1.18 - 1.19
Probe chemical resistant Series STA.	1.20
Compact models Series SC 440 / SCS 440	1.21 - 1.22
Compact models Series SNS 450 / SN 450	1.23 - 1.27
Compact models with analog output Series SNS 450 / SN 450	1.28 - 1.29
Compact models with two switching points Series SN 450	1.30
Compact models with temperature controll Serie SNT 450	1.31 - 1.33
Compact models with turn on/off delay Series SN 450	1.34
Inline-Sensor Series SD	1.35
Inline-Compact Series SDN / SDNC.	1.36 - 1.41
Special-Probe Food / Pharma Series SCB / STB / STC	1.42
Inline-Compact Series SDB / SDN / SDTN	1.43 - 1.45

Flow sensors Inline-Flow monitoring Series SDN / SDV / SDI

Inline-Compact with digital display Series SDN 552 / SDN 554	1.46 - 1.50
Vortex-Measuring device with digital display Series SDV 652	1.51
Magnetic flowmeter with digital display Series SDI 852 / SDI 853	1.52 - 1.53

Air flow sensors Series 400 / Series 500

Probe Series LTZ 421	1.54
Compact models Series LN / LG / LD	1.55 - 1.56
Compact models Series LNZ 450.	1.57 - 1.58
Compact models sleeve mounting Series LN 450.	1.59 - 1.60
Compact models air flow Series LDN	1.61

Amplifiers for sensors

Amplifiers Series SKM / SKZ	1.62 - 1.64
---------------------------------------	-------------

Flow sensors, air flow sensors and amplifiers for Ex-applications

Ex-Probe Series STS / ST – Category 1 / Category 2	1.66 - 1.73
Ex-Probe Series STS / ST – Category 1 / Category 2 with flange	1.74 - 1.76
Ex-Probe Series STSEX – Category 1 with terminal clamps.	1.77
Ex-Inline-Sensor Series SD4 / SD9 – Category 2.	1.78
Air flow sensors Ex-Probe Series STS – Category 1 / Category 2	1.79 - 1.81
Air flow sensors Compact model Series LG / LNZ / LN – Category 3	1.82 - 1.84
Amplifiers Series SZA / SEA / SS	1.85 - 1.88
Ex-Housing for screw terminals Series GK	1.89
Ex-Lightning protection	1.90

Accessories

M12 connector	1.91 - 1.92
Cable	1.93
Assembly parts	1.94 - 1.95

Technical alterations are reserved to us without prior announcement.

Technique and application

Function

The function of the flow controller is based on the thermodynamic principle. The sensor is heated internally a few degrees °C compared to the medium into which it projects. When the medium flows, the heat generated in the sensor is conducted away by the medium, i. e. the sensor cools down. The temperature within the sensor is measured and compared to the temperature of the medium. The state of flow can be derived for each medium by the temperature difference attained.

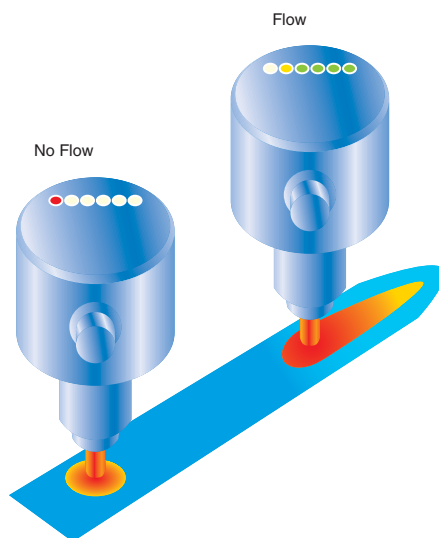

Function of thermodynamic flow controllers

On the basis of this functional principle EGE manufactures flow monitors for liquid and gaseous media.

The sensitivity of thermodynamic flow monitors depends on the thermal characteristics of a medium. The detection range of a standard sensor for oil, for example, is three times as great than for water and for air is approx. 30 times greater than for water due to the reduced heat conductivity. Unless stated otherwise, the technical sensor data are specified for water.

Areas of application for flow monitors

Thermodynamic flow monitors function without any moving parts, therefore they are not subject to failure due to corroded bearings, torn impellers or deflector deformation. This reliability is highly valued in many industries. Today, flow monitors are used both in liquids and in air, and are employed even in explosion hazardous environments.

Monitoring of cooling

- The cooling water on welding machinery is monitored using compact stainless steel devices. This ensures sufficient cooling even for rapid cycles, otherwise the welding robot will be switched off by the sensor.
- The cooling lubricant flow is monitored continuously in processing centres. The tools are protected and have a greater service life.

- In metal processing, e.g. rolling mills and wire drawing machines, the rolls and coils will be cooled continually. This is monitored by thermodynamic sensors. Due to the rough environmental conditions the sensors are designed for up to 160 °C and settings are made away from the heat with special amplifiers.

Monitoring of flow medium

- The run-dry protection of pumps is a frequent application, which often uses compact sensors with time delay.
- In dosing technology the aggregate, usually small flow quantities, is measured exactly by means of inline sensors. These sensors are inserted like a pipe into the line.
- Monitoring of filters and sieves can be ensured by medium flow control; if the flow is progressively reduced, the filter must be renewed. Where this is not carried out, the pump is switched off in a second stage should the medium flow drop further. This uses a sensor with two switching points.

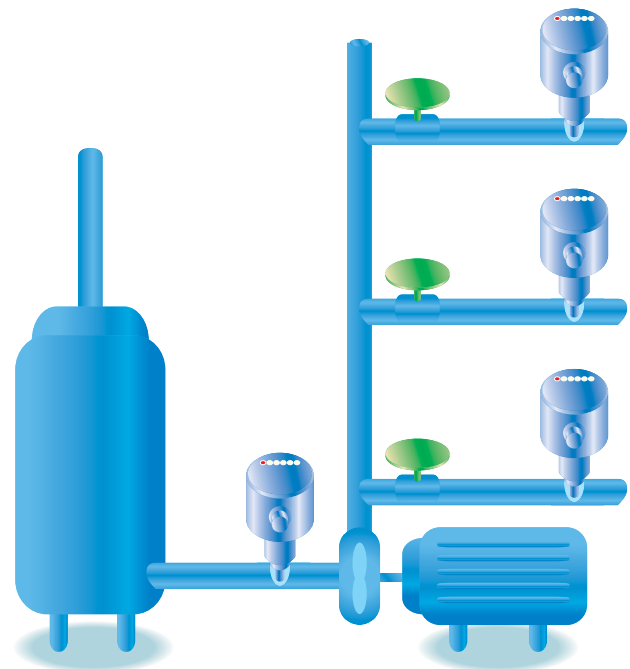

Run-dry protection of a feed pump

Monitoring of process flow

- The monitoring of cleaning processes using aggressive media at times is often only possible with special materials, e.g. hastelloy or tantalum.
- Extraction systems for hazardous vapours at laboratory workstations as well as the hall ventilation in the hexane processing industry are monitored using airflow sensors.
- CIP/SIP processes can be monitored and documented with flow monitors.

Technique and application

Probes

The temperature-sensitive measuring elements are fitted in the tip of the probe. The probe tip and the adjoining thread/mounting part are made in one piece of stainless steel in many probes. This guarantees absolute tightness and high compressive strength. Special materials are used in corrosive, and particularly in oxidizing media, since stainless steel shows only limited resistance to corrosion in this application. In standard applications, probes can be mounted independently of the direction of flow of the medium. In any case, it is important to make sure that the pin of probe is completely surrounded by the medium to be monitored. Please note that for smaller cross-sections the sensor tip narrows the tube's cross-section. This results in a higher flow rate. In order to avoid malfunctions caused by unstable flow patterns no fittings that could affect the flow cross-section or the flow direction should be placed directly in front of and behind the sensor. The point of reference for the input/outlet section is approximately 4 to 8 times the tube diameter.

Assembly

Probes with short thread-pieces of the STK... type are particularly suited for fitting into T-pieces. Sensor length is designed in such a way that the probe tip is completely immersed in the medium without touching the opposite side.

Probes with long thread-pieces of the ST... type are suitable for larger pipe diameters or for use with longer assembly thread-pieces.

Probes threads are G-pipe threads to DIN ISO 228 and also comply with the BSP standard. A flat gasket centered by a step on the sensor ensures a good seal. A good seal can also be ensured using Teflon tape. For pressure above 30 bar or very high screw-down torques, a flat gasket may be damaged, especially if it is made of plastic. In this case, a recess must be incorporated into the fitting which will keep the gasket in the right position in the case of high loads. PTFE gaskets must always be used with this technique. For high pressure applications, metal gaskets must be used.

The standard material for gaskets is AFM 30/34. Special gaskets made of other materials such as moving iron, copper or PTFE are also available on request.

EX probes

Probes for gas and dust explosion hazardous environments are design approved to ATEX 100a and operated with an approved switching device of series SZA..., SEA... or SS 400.

Dimensions of the gasket

Thread	d	D	h	t
G1/4	13.2	19.5	1.5	1
G1/2	21	27.5	2	1.5
G3/4	26.5	32.5	2	1.5

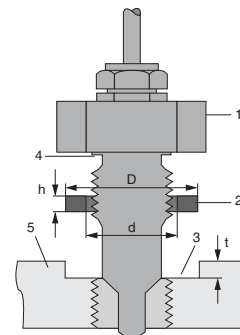

- 1 = Probe
- 2 = Gasket
- 3 = Chamber
- 4 = Locating
- 5 = Counterpart

A rising pipe should be used in case of open systems or in the presence of air pockets. Deposits and air pockets do not impair sensor function in the case of lateral assembly, providing the sensor is completely immersed in the medium. Assembly from below assures flow monitoring function even if there are air pockets in the pipe. However, the monitored medium level must not fall below the upper edge of the measuring tip. Assembly from above is only applicable if there is no air in the pipe.

① Installation in rising pipe

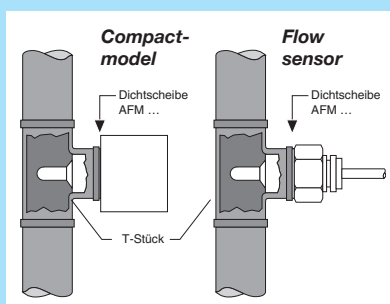

② Lateral installation

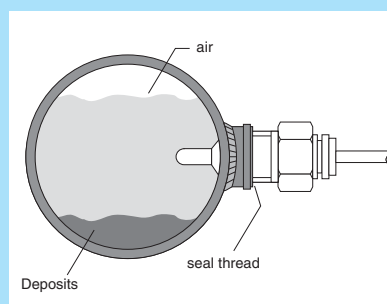

③ Underside installation

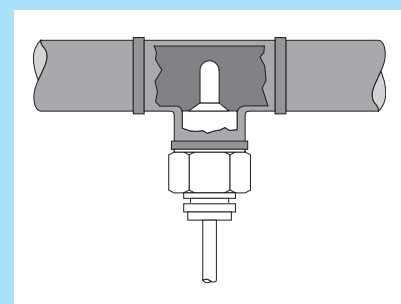

Technique and application

NPT threads

NPT threads can be provided as an alternative for all types which have a G1/2 or a G3/4 thread. NPT threads are conical and must be screwed into an equally conical counter-part. Two types of NPT threads must be distinguished. NPT thread according to ANSI B 1.20.1 does not ensure a good seal by itself and requires the use of a sealing medium, e.g. Teflon tape. It is not possible to use flat gaskets with this type of thread. NPT thread according to ANSI B 1.20.3 does ensure a good seal by itself and requires no further sealing medium. When this type of thread is used, special attention must be paid to the kind of metal used for both parts of the thread, so as to avoid metal seizing when the parts are screwed tight.

Flange types

Standardised pipe connections are required particularly in the chemical, pharmaceutical and foodstuff industries. Sensors for use in these areas are supplied with flange connections per DIN or ASME. Sensor and flange form a corrosion-proof connection using laser or inert gas shielded arc welding.

Food-approved screw connections

For hygienic reasons the food and pharmaceutical industries place special demands on the mechanical and electronic characteristics of sensors.

Probes with food-approved connections, e. g. Triclamp or dairy pipe connections (DIN 11851) comply with the 3-A sanitary standard 28-03. Due to the temperature changes involved, the usual cleaning cycles CIP and SIP place a particular demand on sensor electronics. Therefore, special protective measures are taken. Sensor materials for these applications is mainly the special steel AISI 316 L. Customer-specific connections, e. g. GEA-Varivent or APV flanges are available, as are other special metallic materials.

Extra long probes

Flow probes are available in screw lengths of 25 mm to 300 mm. Probes for use in explosive environments are made of two components if longer than 110 mm and joined corrosion-proof through laser welding. The probe length should be selected such that the measuring tip is within an area of stable flow characteristics.

Main applications are:

- detection of small flow velocities in pipes with large cross section
- mounting of the sensor with a standard flange
- use of extra long welding sleeves if the piping is surrounded by a supplementary insulation.

Long sensor

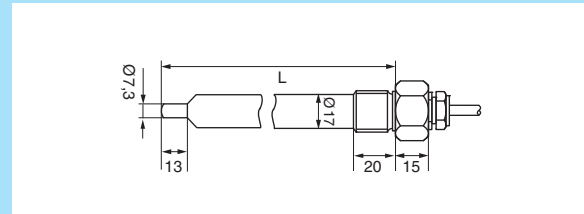

Immersion depth "L" is determined by the distance between the sealing face and the sensor tip. Standard lengths which can be supplied are: L = 80 and 120 mm; in the Ex-area 80, 110 and 140 mm.

Inline

Inline sensors are inserted directly into the line of a pipe. This design does not feature any measuring pins protruding into the flow. EGE inline sensors SD of series 500 are suitable for flow volumes from 0.5 ml/min to 6 l/min. These sensors excel through smooth measuring pipes, low pressure loss and fast response to flow changes. A multitude of connection options are available.

Chemical stability of probe housings

The chemical stability of the materials used must be verified individually for every application. Basically, no problems occur if the probe and the piping are made of the same material. It is always advantageous if the sensor housing is made of a more noble material than the piping.

The screwed cable gland on the rear side of the ST... sensors is designed in nickelplated brass. Order material PVDF for screwed cable glands in applications that are cleaned with alkaline cleaning agents as is the case, for example, in the food industry.

Stainless Steel belongs to the group of chromium-nickel alloys containing further components such as molybdenum or titanium. The proportions of the different alloy components is critical to the resistance to corrosion in the medium. For this reason, there exists a large number of materials identified by numbers to the DIN EN ISO 7153-1:2000 standard. Due to its good corrosive resistance in many areas of application, AISI-316 Ti (VA4) stainless steel is a frequently used material. It may be used in installations used to obtain water, in air conditioning systems, in food processing industries such as dairy products, meat products, beverages, wine production or in kitchen installations. Stainless steels have a restricted stability in chlorinated or poorly oxygenated atmospheres. Special alloys must be used for such applications.

Technique and application

Special materials

Hastelloy B2 (2.4617) belongs to the group of highly corrosion-resistant nickel-molybdenum alloys.

This material has excellent characteristics in reducing media, e.g. in hydrochloric acid of any concentration and for a large range of temperatures. It can also be used in hydrochloric, sulphuric, acetic and phosphoric acid media. Good resistance against corrosion such as pitting, crevice corrosion, chlorine induced stress, corrosion cracking, hair-line corrosion, abrasion and corrosion within the heat influence zone allows for a large range of applications. In the presence of oxidising components such as iron or copper salts, the use of this material is not recommended.

Hastelloy C-22 (2.4602) belongs to the group of high corrosion-resistance nickel-chromium-molybdenum-tungsten alloys. The material is characterised through high resistance against crevice corrosion, pitting and stress corrosion cracking in oxidising and reducing media. It also displays good behavior in the presence of a large number of corrosive media, including strong oxidants such as iron (III) chloride and copper (II) chloride, hot media, e.g. sulphuric acid, nitric acid, phosphoric acid, chlorine (dry), formic acid and acetic acid. Furthermore, it has satisfactory characteristics in humid chlorine gas, as well as in sodium hypochlorite and chlorine dioxide solutions.

Titanium (3.7035) is a light metal with mechanical strength values equivalent to those of high quality steel. The good chemical resistance of this metal is due to the fact that an oxide film is formed on its surface, as is also the case with stainless steels. If this protective layer undergoes mechanical damages in an oxygenated environment, it is immediately renewed (titanium will resist even aqua regia). Titanium is not stable in environments containing no oxygen or in reducing environments. It is particularly suitable for applications in chloride-containing media. Experience in the chemical industry and in paper bleaching factories has shown that titanium is the only material allowing undisturbed production. The excellent characteristics of titanium also give optimum results in sea water cooling systems and sea water de-salinising plants.

The material is particularly suited for the application of coating with other metals and metal ceramics. These supplementary coatings noticeably increase its chemical stability and thus the lifetime of sensor housings.

High temperature

High temperature sensors are manufactured from temperature-resistant components and feature FEP cables.

The functional range of these special probes of series 400 is specified as +10...+120 °C. Temporarily 135 °C is permissible for max. 10 min. High temperature sensors of series 500 can be used for media temperatures of up to 160 °C / 320 °F

Connection

Flow monitoring probes are available with a M12 plug connector or fixed cable. Special models for the hazardous areas have a terminal compartment.

The connection cable from the probe to the amplifier may be up to 100 m long. For distances above 30 m a shielded cable is preferred. In all cases the chosen wire strength must be checked against the requirements.

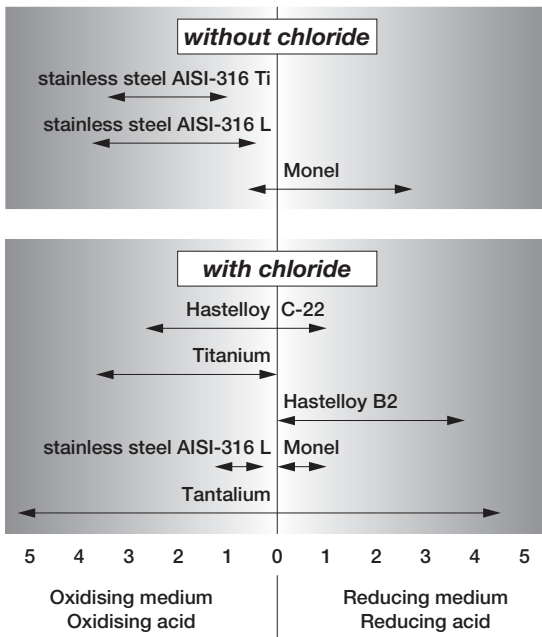

Chemical resistance of B3-coating

Medium	Cl ₂	HCl	Br ₂	HBr	F ₂	HF	HA (general)	NaOH	Saltw. (Kestern)	red. media	HNO ₃	H ₂ SO ₄ (25%)
resistance	+++	+++	+++	+++	+	+	+++	++	+++	++	++	+++

HA in generell = Acid. acid in different concentrations
 Saltw. Kestern Resistance = Saltw.-Kesternich-Test = proofed up to 30 °C

Coating properties

The coating is hard, resistant to wear and resistant to abrasive substances in media like for example chalk, mud, sand and fiber.

Technique and application

Amplifiers

All amplifiers have a multicolour LED display which visually indicates the flow tendency. If the LED light is red, the preinstalled limit value is not reached and the switching output is not activated. The yellow LED indicates that the limit value was reached and the output is active. In addition to the yellow LED, 4 more green LEDs can light up to indicate how much the limit value is exceeded.

For the installation of the amplifiers, make sure that the devices are not subject to heat build-up. The distance between adjacent devices should not be less than 10 mm.

Amplifiers SKZ... and SKM...

Terminal rail devices SKZ... and SKM... are prepared for installation on the top hat rail. They evaluate the signals delivered by the measurement probes and provide relays or analogue outputs. The settings are made using two potentiometers that are accessible from the front or via buttons for SKM 522. In addition, SKZ amplifiers provide a switch-off delay as well as temperature monitoring.

EX amplifiers SEA... and SZA...

For EX measurement probes, the SEA... and SZA... amplifiers are offered. They have their own intrinsically safe circuit to which the measurement probes are connected. This safe circuit is galvanically isolated from the mains and isolated from the relay or analogue output.

The EX amplifiers SEA... and SZA... have to be set up outside of the hazardous area so that at least protection class IP20 is achieved as specified by EN 60529. During installation either a separator must be used between the intrinsically safe and non-intrinsically safe connections of the EX amplifier so that the minimum distance is 50 mm (strand size), or each connection must be individually enclosed using a non-slip sleeve (heat shrink sleeve). A crimping sleeve is also permissible.

EX amplifiers SS 400 Ex

The amplifier SS400 has an intrinsically safe circuit to which a measurement probe is connected. This amplifier may be installed in a category 2 hazardous area (zone 1).

Compact devices

Compact devices integrate amplifier and probe within one housing. This permits setting a limit value directly at the measuring location. The cabling is thus reduced to the less interference-prone mains supply cables and the switching output.

SN... / LN... designs

The SC 440 series is available in an all stainless steel design and have been proven for more than 20 years in industrial applications. They are characterized by their small size and ruggedness and are available in a threaded and a plug-in version.

Compact models with plastic housings are offered under the type designations SN 450 / LN 450. They come in a multitude of electrical designs. The devices are available as DC and AC versions and fitted with a PNP, relay or analogue output. Special designs further incorporate limit temperature monitoring or a shut-down time delay.

Inline compact devices SDN

Inline compact devices SDN 500... are inserted inline into a pipe. The measuring pipes are smooth inside and do not have any components protruding into the flow. They are characterised by short response times and a large detection range. Due to their small shape they can also be used where installation room is sparse. The SDN 500... are fitted with PNP, relays, or analog outputs. For pulsating flows the EGE programme contains a compact device capable of detecting very short flows of smallest amounts at the start of the flow.

Inline compact devices SDNC

The SDNC 503 series has a space-saving cubic design. They are characterised by a wide detection range and are operated with a screw adapter which guarantees a favourable flow profile for the flow detection. This series is factory-preset and ready to use in aqueous media. This design also provides a pulse output for easy volume determination.

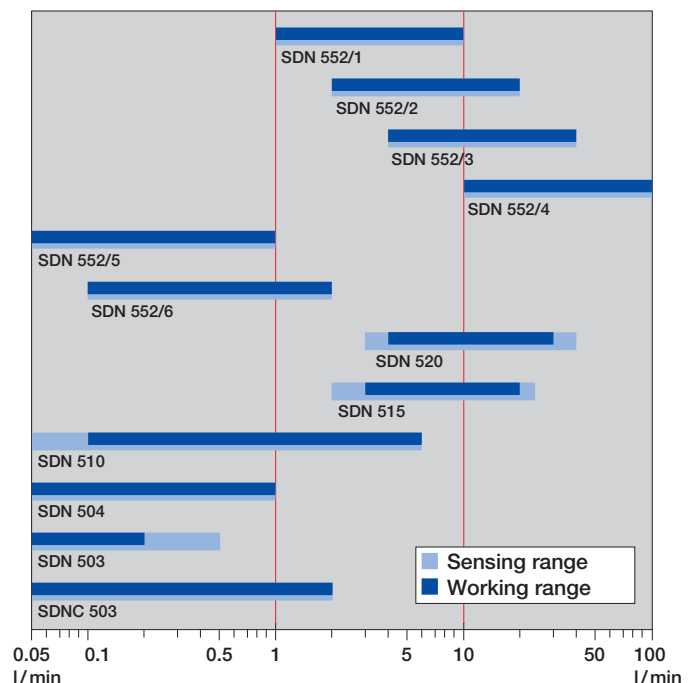

Flow ranges for EGE-Inline-Compact models

Technique and application • Terminology

Detection range

The detection range of a probe or compact device indicates the flow velocities of the medium for which the probe can provide an analysable signal. If the medium is not specified, the details for water are applied. Because the different media have different thermal conductivity, the detection range as well as the temperature drift are also dependent of the respective medium.

At the upper and lower limit of the detection range, the temperature drift is higher. The detection range does not limit the maximum flow rate a sensor may be exposed to. Hence, a sensor with the upper detection limit set at 3 m/s can be operated at 10 m/s.

Working range

The working range indicates the section of the detection range for which the flow data is specified. At the outer limits of the detection range, this data is reduced.

Nominal flow

For each sensor, data corresponding to its own nominal flow is measured. This is necessary because response characteristic curves of sensors are non-linear. Consequently the various sensor characteristics depend on the location of the chosen operating point on the curve. As a rule, the nominal flow-point is set in the middle of the portion of the (simple logarithmic representation of the characteristic) curve which appears to be linear. For this operating point, the following values may be defined: switching on and off times, stand by time, hysteresis and temperature response.

Supply voltage

The supply voltage is the voltage range within EGE Sensors function safely. For direct current supplies it must be ensured that the limits are maintained even including residual ripple.

Current consumption

The current consumption is the maximum value of the idle current I_0 which the flow monitor draws without load.

Switching current

The switching current indicates the maximum continuous current for the switching output of the device. For PNP outputs this value applies to an ambient temperature of 25 °C. At higher temperatures the maximum switching current is reduced. For devices with relays output the value is related to the utility category AC-12 or DC-12 in accordance with EN 60947-5-1.

Switching voltage

The switching voltage indicates the maximum voltage (including residual ripple) to be switched with the relay output.

Switching power

The switching power indicates the maximum power to be placed on the output relays.

Ambient temperature

The ambient temperature indicates the maximum and minimum permissible temperatures for the sensor.

Temperature of medium

The temperature range for which a sensor is rated. Applies to the medium to be monitored.

Temperature gradient

The change of the medium's temperature within a defined period of time is called temperature gradient. If the change of medium temperature exceeds this value, there will be a malfunction of the flow controller.

Start-up time

The start-up time is the period of time required by the flow detector to reach a stable state after the operating voltage has been switched on. Prerequisite is that the medium flows at the rated velocity and that the sensor has adapted to the temperature of the medium before switching the supply voltage on. The start-up time is prolonged in a static medium and reduced if the medium flows faster than the rated value.

Reaction time

The reaction time combines the switch-on and -off time. Switch-on time elapses from the beginning of the flow until the switching point set at the amplifier is reached. Switch-off time characteristic results for the flow sensors at pump shut-down. If the set switching point is close to maximum flow, the time elapsing between the pump shut-down and the indication of the flow decrease is short. If the switching point is close to the static value, the off-transition time will be long.

Compressive strength

Pressure resistance relates to the sensor casing. Up to the indicated maximum pressure, the sensor provides a steady signal and the casing suffers no damage. In case the application requires the use of threaded joints, these can have compressive strengths that are significantly lower than the data for the sensor, which must then be observed.

Protection class

The protection class indicates how well the equipment is protected against ingress of solids and water in accordance with EN 60529. For probes, the stated protection class always refers to the connection area. The area which is in contact with the medium always has IP 68.

Switch-off delay

The variable time delay which can be set between 0 and 25 seconds becomes active during flow standstill (drop-out delay). If the medium ceases to flow and the amplifier display indicates this state, the relay contact is actuated only after the set delay. During the delay period the yellow LED lights up together with the red LED.

Cable break monitoring

Cable break monitoring shuts off the flow monitor output if no probe is connected or if the probe cable has been severed. In case of cable severing, "flow failure" signal is displayed. For the SEA 401 in particular, the wire break alarm will be indicated with a separate switch output.

Switching output

Setting with flow off

1. Install the sensor in the flow duct and switch on the device. Wait for ready state.
2. Carry out the potentiometer adjustment so that the red LED lights up.
3. When the medium begins to flow, at least one green LED should light up.

Setting with flow on

1. Install the sensor in the flow duct and subject it to flow. Switch on the device. Wait for ready state.
2. Carry out the potentiometer adjustment so that two green LEDs light up.
3. If the flow is interrupted, the red LED should light up.

Setting for flow below threshold

This adjustment is only possible if the flow rate lies within the measuring range of the chosen probe.

1. Install the sensor in the flow duct and switch on the device. Apply the specified flow. Wait for ready state.
2. Set the potentiometer so that the red LED just lights up.
3. When the flow increases, the red LED is extinguished, the yellow LED lights up and the sensor switches.

Setting for flow higher than threshold

This adjustment is only possible if the flow rate lies within the measuring range of the chosen probe.

1. Install the sensor in the flow duct and switch on the device. Apply the specified flow. Wait for ready state.
2. Set the potentiometer so that the first green LED lights up.
3. If the flow rate decreases the green LED will extinguish first, then the yellow LED then the relay drops out and the red LED will light up.

The switch point for flow velocity is set with two potentiometers for coarse and fine adjustment. If the flow velocities are higher than the detection limit of the connected probe, flow failure or reduction will be displayed once the medium flow velocity has dropped back within the probe detection range.

Adjustment of the limit temperature

The desired values can be set using a potentiometer. The output is actuated when the set value is exceeded. At the same time, the corresponding LED lights up.

Time delay and limit temperature of medium



Desired values can be set by means of a potentiometer located on the switching amplifier.

Values are indicated on a scale for SKZ... models. If the set time lag has not yet elapsed, the yellow LED will remain alight, even though the red LED indicates flow failure.

Automatic adjustment for SKM 522

Simultaneously pressing the two front buttons will open the programming menu. The automatic adjustment is selected with the FUNCTION button and started with the SELECT button. The adjustment is completed a few seconds later when at least the yellow LED lights up. Flow rate and temperature must be kept constant before and during the adjustment process. The function MAN. ADJUST can subsequently be used to manually modify the switching point.

LED functions flow

-  **Red:**
Flow has been interrupted or the flow rate has fallen below the specified value. The "flow" relay has dropped out.
-  **Yellow:**
The set flow rate has been reached, the "flow" relay pulls in.
-  **Green:**
The set flow rate has been exceeded. There is extra flow capacity.

LED temperature function

-  **Red:**
The set temperature value is reached and the "temperature" relay has pulled in.

LED time delay function

-  **Yellow and Red:**
Flow is below the set value. "Flow" relay remains pulled in until the set switch-off delay runs out.

Analog output

The SKM 420 GA supplies a current intensity which depends on the flow speed. The output current range is defined from 4 mA to 20 mA. The dependence between flow speed and output current is non-linear. The detection range is adjusted over two potentiometers: "Range" (↙) and "Adjust" (↗). The lowest value (>4 mA, 1st green LED) is set with the "Adjust" potentiometer at the smallest flow speed to be monitoring and the highest value (20 mA, 5th green LED) is set with the "Range" potentiometer at the highest flow speed to be monitored. The graph shows the characteristic lines obtained with the different settings.

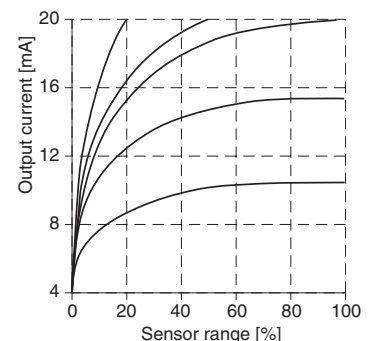
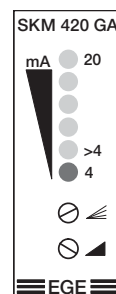

Flow monitoring and measuring

The EGE-inline flow controllers with digital display monitor flow rates in the range of 0,05...100 l/min and display the flow rate digitally. They feature front panel buttons used to call functions and modify settings. The application area includes all areas of flow monitoring and measuring, in which a flow display is desired.

Series SDN 552 / 554 – thermal principle

The SDN 552/554 series is based on the thermodynamic principle, heat is created in a measuring pipe and absorbed by the passing medium. The dissipated heat quantity is a measurement for the flow speed. A microprocessor processes this data, calculates the flow rate quantity and displays the result in liters/minutes in a 3-digit, 7-segment display.

Page 1.46 - 1.50

Series SDV 652 – vortex principle

The flow measurement devices Series SDV 652 are based on the vortex principle. They are well suitable for applications, where a good linearity and larger measurement precision is necessary. They are insensitive to quick temperature changes and the reaction time of the device is below one second. The vortex principle allows a flow measurement without moving parts: Behind a bluff body in the flow, vortices are generated which are detected by the device and yield the flow velocity.

Page 1.51

Series SDI 852 / 853 – magnetic-inductive

The inline flow sensors SDI 852/853 offer a monitoring function as well as precise flow measurements in the range of 0...80 l / min with a measured error smaller than 2%. The flow rate is digitally depicted using a clear 3-digit, 7-segment display. The magnetic-inductive measuring system facilitates that this device is suitable for many different applications in the field of automating processes and work-flows. Furthermore, a high degree of measuring accuracy is ensured.

The magnetic-inductive measuring principle requires the electrical conductivity of the medium. Low limit values of 15 $\mu\text{S}/\text{cm}$ for water or 10 $\mu\text{S}/\text{cm}$ for other fluids still offer a broad function range.

The combination of precise measuring system and small, compact design distinguishes the series SDI from other inline flow sensors. They are easy to install subsequently into existing configurations or offer a space-saving alternative for new constructions.

Cooling and temperature control as well as metering circuits, for example in the field of water treatment, are precisely and accurately monitored. This is accomplished with a set point function as well as an analogue linear current and pulse output.

Page 1.52 - 1.53

Installation

The inline flow sensors are installed "in-line" into a pipe line. The pipe may be connected directly with the compression tube fitting connection or with an adaptor SDA.... Threaded bushings are located in the bottom housing plate and are used to fasten the device to a support plate or other similar base. A mounting plate (optional accessory) may also be attached to the housing. This makes it possible to fasten the unit from the front.

Signal filter

The parameter for the signal filter allows inputting a value that determines the time interval in which the measuring signal is averaged. Inputs between 0 to 8 seconds are possible. A low value results in a very quick response; a high value results in a very steady display of the measured value. The filter is switched off when the setting is 0. Averaging has the same effect on display and outputs.

Access code

Protection against unauthorized access to the programming functions provides an access code. Without this number combination, only the currently saved values for the switching points and further parameters can be displayed.

Reference adjustment

The accuracy of the displayed flow rate quantity can be optimized with the CAL function using an exact reference flow rate meter. Here you have the option to modify the displayed flow rate value and adapt it to the reference value.

Medium preselection SDN 552 / 554

Besides water, a water-glycol mixture is also often used as a heat carrier in cooling systems. Due to the changed thermal properties of the fluid through the incorporation of glycol, the accuracy of the displayed flow rate value is affected and the limit values are also changed. To correct this effect, the devices of the SDN 552/554 type series have a function for selecting the measurement medium. Glycol fractions up to 30% can be entered. The microprocessor working in the device then calculates the flow rate quantities considering the glycol fraction.

Applications

These devices are especially suitable for flow rate monitoring in cooling systems due to the greater functionality, as well as easy programming and installation.

These devices are characterized by short response times and robust display values, even if the medium is subject to large temperature fluctuations as to be found in welding technology in the automotive industry.

In the display, the flow rate value, which is continuously updated, is displayed in l/min. The person responsible for the plant or the machine has thus constantly the information on the available cooling performance.

Industrial climate control units are often operated with a water-glycol mixture in the secondary cycle due to the danger of freezing. The glycol fraction can be programmed in the SDN menu in a couple of seconds to ensure a correct value is also displayed in the application.

Use in hazardous areas

The EX measurement probes of the 400 series as well as the amplifiers SEA..., SZA... and SS 400 meet the basic requirements of Directive 94/9/EC. EC type examination certificates for category 1 and 2 are available.

Electrical boundary data, permissible temperature ranges as well as installation and connection instructions are specified in the operating instructions of EX equipment.

Lightning protection SBGX 01

If lightning protection measures are required according to DIN EN 62305, among others, the SBGX 01 can be used. This device is inserted in the sensor line between the measurement probe and amplifier. The voltage induced in the sensor line by a lightning strike is limited and diverted to earth.

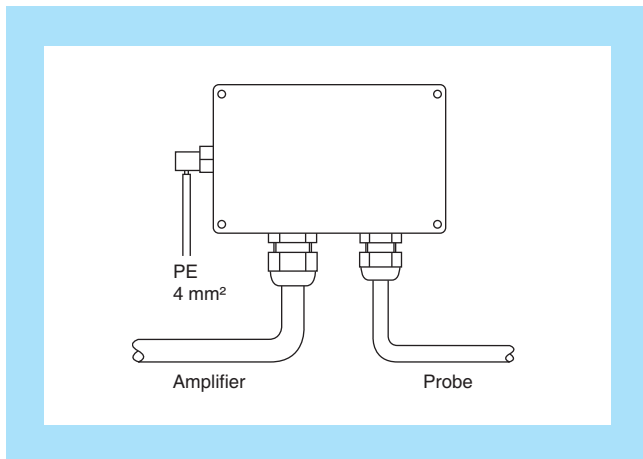

Zone classification and categories

The frequency and duration of the occurrence of a hazardous atmosphere determines the zone classification.

Zone 0 / Category 1 (Gas)

Zone 0 is an area in which a potentially explosive atmosphere in the form of a mixture of air, combustible gases, vapours or fog continuously, for longer periods or frequently exists.

Zone 1 / Category 2 (Gas)

Zone 1 is an area in which a potentially explosive atmosphere as a mixture of air, combustible gases, vapours or fog can occasionally form in normal operation.

Zone 2 / Category 3 (Gas)

Zone 2 is an area in which a potentially explosive atmosphere as a mixture of air, combustible gases, vapours or fog can occur in normal operation.

Zone 20 / Category 1 (Dust)

Zone 20 is an area in which a potentially explosive atmosphere in the form of combustible particles suspended in air continuously, for longer periods or frequently exists.

Zone 21 / Category 2 (Dust)

Zone 21 is an area in which a potentially explosive atmosphere in the form of combustible particles suspended in air can occasionally form in normal operation.

Zone 22 / Category 3 (Dust)

Zone 22 is an area in which a potentially explosive atmosphere in the form of combustible particles suspended in air normally does not exist or only exists for a short period in normal operation.

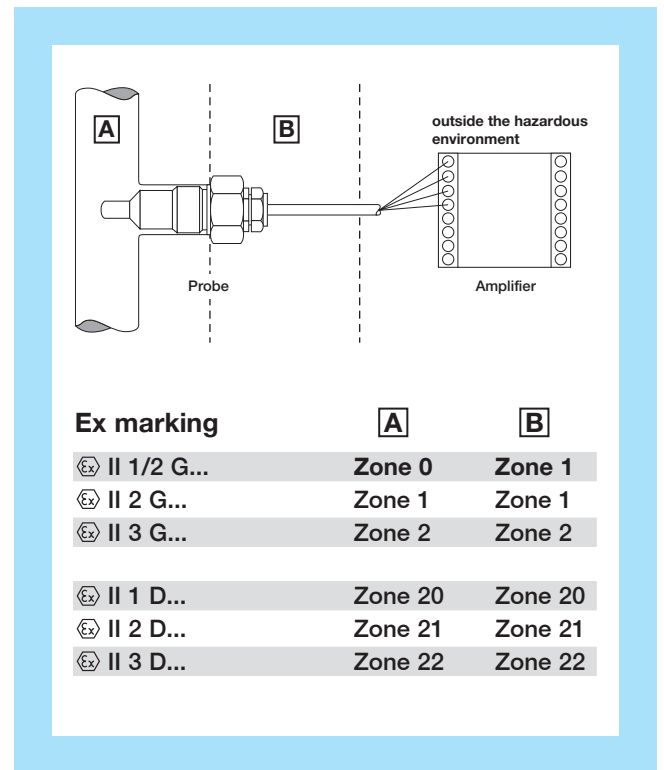

A measurement probe may only be used in dust or gas protected hazardous areas, even when there are approvals for both areas. For use in hazardous areas for dusts the maximum surface temperature of the sensor is specified. For the hazardous area for gases the ambient temperatures of the temperature classes are given.

On request, EGE delivers sensors with special dimensions and special materials as well as longer connection cables.

Technique and application

Valid standards

EN 60947-5-2

Control units; low voltage control units, auxiliary switch, proximity switch

EN 61000-6-4

Electromagnetic compatibility (EMC)
Interference emissions in the industrial area

EN 61000-6-2

Electromagnetic compatibility (EMC)
Generic standards immunity for industrial environments

EN 61000-4-2 (ESD)

Electrostatic discharging immunity

EN 61000-4-3 (HF radiated)

Radiated radio-frequency electromagnetic field immunity test

EN 61000-4-4 (Burst)

Electrical fast transient / burst immunity test

EN 61000-4-5 (Surge)

Surge immunity test

EN 60529

Protective system, IP-designation

EN 60079-0: 2012

Explosive atmospheres -
Part 0: Equipment - General requirements

EN 60079-11: 2012

Explosive atmospheres -
Part 11: Equipment protection by intrinsic safety "i"

EN 60079-18: 2009

Explosive atmospheres -
Part 18: Equipment protection by encapsulation "m"

EN 60079-26: 2007 including Correction: 2009

Explosive atmospheres -
Part 26: Equipment with equipment protection level (EPL) Ga

Authorisations

TÜV NORD CERT Zertifizierungsstelle - Deutschland
(technical monitoring certification agency - Germany)

Approval for safety applications

Sensors for personal security must have a qualification approval according to EN 61508 and must be labeled accordingly. Sensors that are not labeled must not be used for applications of this kind.

Certification

TÜV NORD CERT ISO 9001 : 2008

TÜV NORD CERT Quality control production
Attachment IV of the
EU-Guidelines 94/9/EG
DIN EN ISO/IEC 80079-34 : 2012

TÜV Nord Re-stamping certificate according to
EN 10204

Code: BK = black BN = brown BU = blue GN = green YE = yellow GY = grey PK = pink WH = white



Probes
Compact models
Amplifiers

Probe • Plug-in installation

Series ST

Connection thread
M18x1.5

Stainless steel

Plug-in installation
Can be used universally with
an adapter for M18x1.5

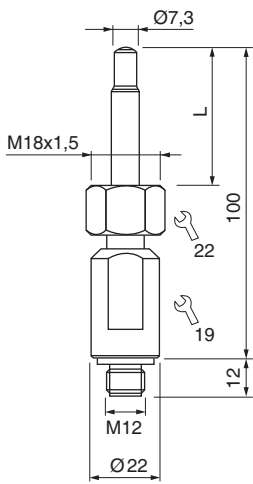
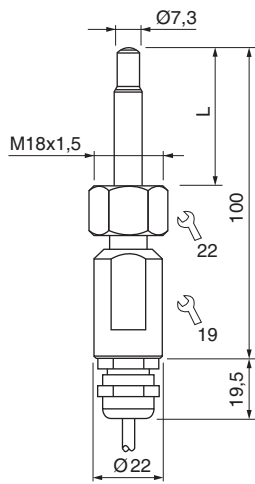

Design	M18x1.5		M18x1.5
Dimensions			
Detection range [cm/s]			
Water	1...150	1...150	1...150
Oil	3...300	3...300	3...300
Sensor length L [mm]	47	47	47
ID-No.	P11354	P11355	P11356
Type	ST 418 S-A4	ST 418 K-A4	ST 418 KH-A4
Medium temperature [°C]	-20...+80		+10...+120
Temperature gradient [K/min]	250		250
Start-up time typ. [s]	8 (2...15)		8 (2...15)
Reaction time typ. [s]	2 (1...13)		2 (1...13)
Compressive strength [bar]	100		100
Sensor material	AISI 316 Ti		AISI 316 Ti
Protection [EN 60529]	IP 67	IP 68	IP 68
Connection	M12 connector	2 m PVC-cable 4x0.25 mm ²	2 m FEP-cable 4x0.25 mm ²

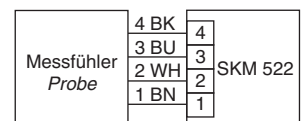
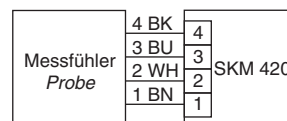
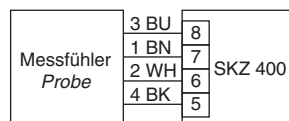
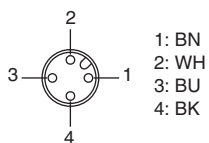

Amplifiers required: SKM..., SKZ..., see page 1.62 - 1.64

Accessories connecting cable type SLG, SLW (See 1.91), Screw-in adapter SDA-SCS-... (page 1.95)

Probe • Standard thread

Series ST

G1/2 thread

Stainless steel PTFE-Housing

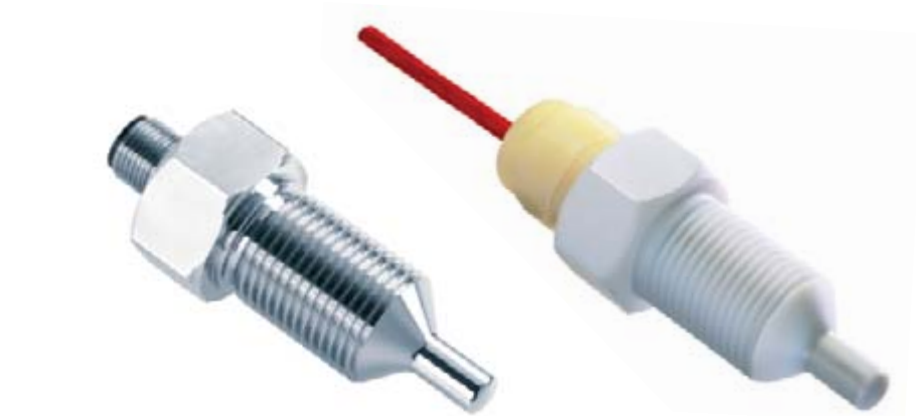

Design	G1/2	G1/2	G1/2 PTFE
Dimensions			
Detection range [cm/s]			
Water	1...150	1...150	1...70
Oil	3...300	3...300	2...100
Sensor length [mm]	48	48	48
ID-No.	P10412	P10414	P10431
Type	ST 421 K-A4	ST 421 S-A4	ST 421 K-F
Medium temperature [°C]	-20...+80		-10...+70
Temperature gradient [K/min]	250		1
Start-up time typ. [s]	8 (2...15)		60 (40...100)
Reaction time typ. [s]	2 (1...13)		30 (10...50)
Compressive strength [bar]	100		5
Sensor material	AISI 316 Ti • different material on request		PTFE
Protection [EN 60529]	IP 68		IP 68
Connection	2 m PVC-cable 4x0.25 mm ²	M12 connector	2 m FEP-cable 4x0.25 mm ²

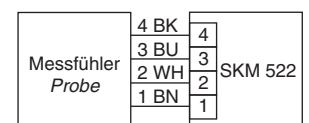
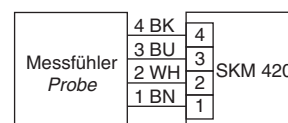
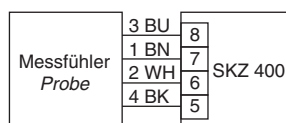
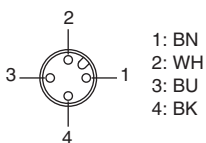

Amplifiers required: SKM..., SKZ..., see page 1.62 - 1.64

Accessories

connecting cable type SLG 4-2 (Z00445), SLW 4-2 (Z00446), see page 1.91

Probe • Short thread

Series STK

G1/4 thread

G1/2 thread

Stainless steel

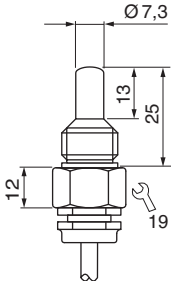
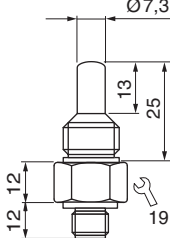
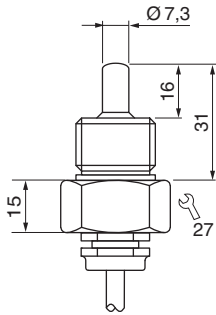
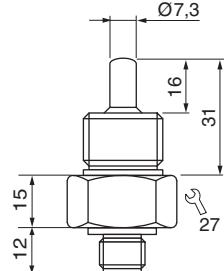

Design	G1/4	G1/4	G1/2	G1/2
Dimensions				
Detection range [cm/s]				
Water	1...150	1...150	1...150	1...150
Oil	3...300	3...300	3...300	3...300
Sensor length [mm]	25	25	31	31
ID-No.	P10402	P10404	P10408	P10410
Type	STK 412 K-A4	STK 412 S-A4	STK 421 K-A4	STK 421 S-A4
Medium temperature [°C]	-20...+80			
Temperature gradient [K/min]	250			
Start-up time typ. [s]	8 (2...15)			
Reaction time typ. [s]	2 (1...13)			
Compressive strength [bar]	100			
Sensor material	AISI 316 Ti • different material on request			
Protection [EN 60529]	IP 68	IP 67	IP 68	IP 67
Connection	2 m PVC-cable 4x0.25 mm ²	M12 connector	2 m PVC-cable 4x0.25 mm ²	M12 connector

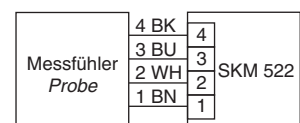
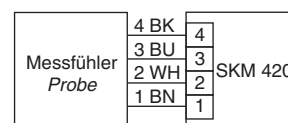
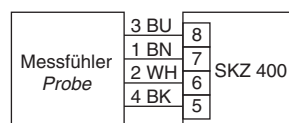
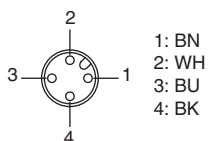

Amplifiers required: SKM..., SKZ..., see page 1.62 - 1.64

Accessories connecting cable type SLG 4-2 (Z00445), SLW 4-2 (Z00446), see page 1.91

Probe • Extra long

Series ST

G1/2 thread

Stainless steel

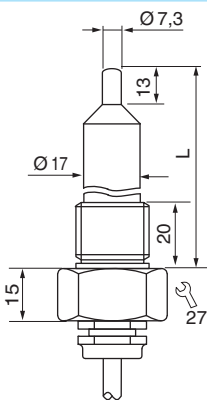
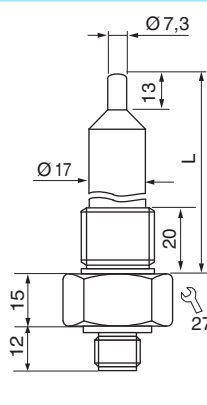

Design	G1/2		G1/2	
Dimensions				
Detection range [cm/s]	1...150 3...300		1...150 3...300	
Water				
Oil				
Sensor length L [mm]	80	120	80	120
ID-No.	P10901	P10902	P10904	P10905
Type	ST 421 K-L80	ST 421 K-L120	ST 421 S-L80	ST 421 S-L120
Medium temperature [°C]	-20...+80			
Temperature gradient [K/min]	250			
Start-up time typ. [s]	8 (2...15)			
Reaction time typ. [s]	2 (1...13)			
Compressive strength [bar]	100			
Sensor material	AISI 316 Ti • other materials on request			
Protection [EN 60529]	IP 68		IP 67	
Connection	2 m PVC-cable 4x0.25 mm ²		M12 connector	

Extra long sensors up to 300 mm on request

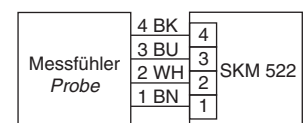
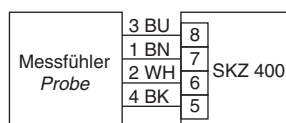
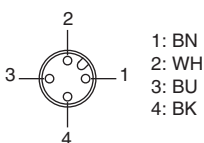

Amplifiers required: SKM..., SKZ..., see page 1.62 - 1.64

Accessories connecting cable type SLG 4-2 (Z00445), SLW 4-2 (Z00446), see page 1.91

Probe • High temperature 120 °C

Series ST

G1/4 thread

G1/2 thread

G3/4 thread

Stainless steel

High temperature sensors 120 °C

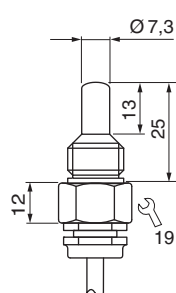
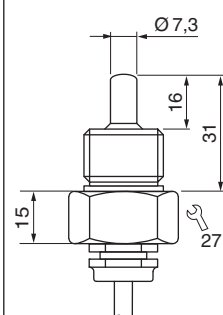
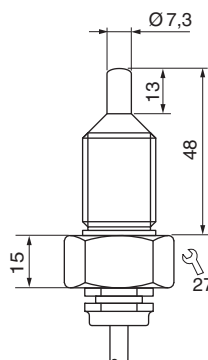
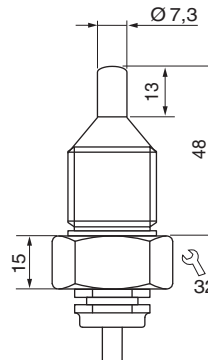

Design	G1/4	G1/2	G1/2	G3/4
Dimensions				
Detection range [cm/s]				
Water	1...150	1...150	1...150	1...150
Oil	3...300	3...300	3...300	3...300
Sensor length [mm]	25	31	48	48
ID-No.	P10435	P10436	P10437	P10438
Type	STK 412 KH-A4	STK 421 KH-A4	ST 421 KH-A4	ST 431 KH-A4
Medium temperature [°C]	+10...+120			
Temperature gradient [K/min]	250			
Start-up time typ. [s]	8 (2...15)			
Reaction time typ. [s]	2 (1...13)			
Compressive strength [bar]	100			
Sensor material	AISI 316 Ti • different materials on request			
Protection [EN 60529]	IP 68			
Connection	2 m FEP-cable, 4x0.25 mm ²			

High temperature sensors may be used for temperature up to 120 °C. A short-time overload up to 135 °C is allowed; within this time the switching point is not specified. After returning back to temperatures below 120 °C the sensor will work properly again.

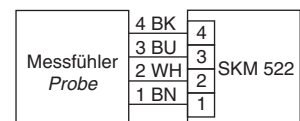
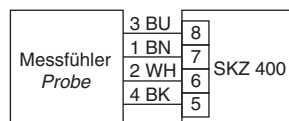

Amplifiers required: SKM..., SKZ..., see page 1.62 - 1.64

Probe • High temperature 160 °C

Series ST 521

G1/2 thread

Resistant to hot steam

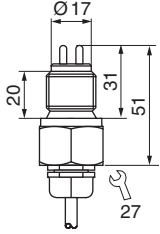
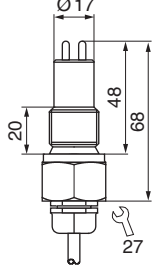
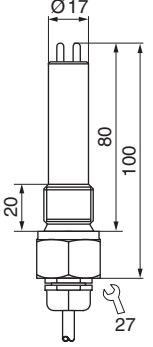

Design	G1/2		
Dimensions			
Detection range			
Fluids [cm/s]	1...300	1...300	1...300
Air / gas [m/s]	1...40	1...40	1...40
Sensor length [mm]	31	48	80
ID-No.	P11259	P11260	P11261
Type	ST 521 KH	ST 521/1 KH	ST 521/2 KH
Medium temperature [°C]	fluids +10...160 – air/gas +10...135		
Temperature gradient [K/min]	fluids 250 – air/gas 20		
Start-up time [s]	5...20		
Reaction time [s]	2...20		
Compressive strength [bar]	60		
Protection [EN 60529]	IP 67		
Sensor material	AISI 316 Ti • different materials on request		
Connection	2 m FEP-cable 4x0.25 mm ²		

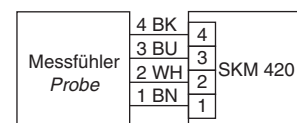
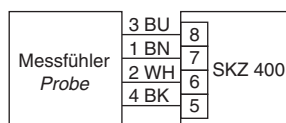

Amplifiers required: SKM..., SKZ..., see page 1.62 / 1.64

Probe • Chemical resistant

Series STA

G1/2 thread

Hastelloy B2/C22

Metal ceramic coated

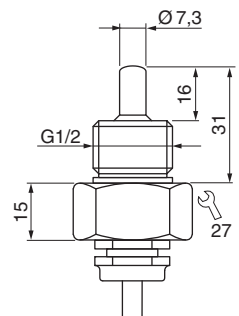
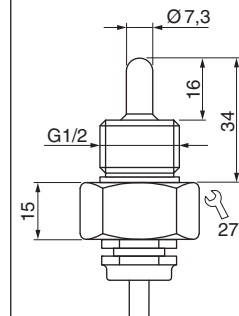
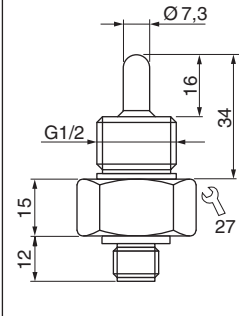
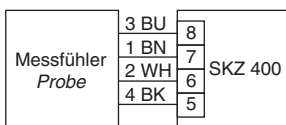
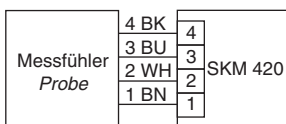
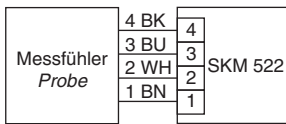

Design	G1/2...HB2/HC22		G1/2...K-B3	G1/2...S-B3
Dimensions				
Detection range [cm/s]				
Water	1...150	1...150	1...150	1...150
Oil	3...300	3...300	3...300	3...300
Sensor length [mm]	31	31	34	34
ID-No.	P10625		P10623	P10622
Type	STA 421 K-HB2	STA 421 K-HC22	STA 421 K-B3	STA 421 S-B3
Medium temperature [°C]	-20...+80 (+10...+120 on request)			
Temperature gradient [K/min]	250			
Reaction time [s]	1...15			
Compressive strength [bar]	100			
Sensor material	Hastelloy B2	Hastelloy C22	Titanium / metal ceramic	
Protection [EN 60529]	IP 68			IP 67
Connection	2 m FEP-cable 4x0.25 mm ²			M12 connector
			<p>These sensors are made of titanium and are coated with a metal-ceramic material layer. Coated sensors display chemical resistance practically comparable to chemical characteristics of PTFE or Hastelloy. Unlike PTFE sensors, coated sensors display the same temperature behaviour as stainless steel sensors, with high temperature gradients.</p> <p>The high surface hardness of the coating protects the sensor against abrasion, thus considerably increasing its durability. The perfectly smooth surface virtually eliminates deposits.</p>	
				
				
	<p>Amplifiers required: SKM..., SKZ..., see page 1.62 - 1.64</p>			
Accessories	connecting cable type SLG 4-2 (Z00445), SLW 4-2 (Z00446), see page 1.91			

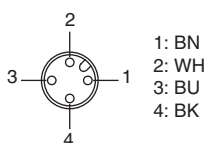

Compact models DC • PNP output

Series SC 440 - Flow controller

DC 24 V

Stainless steel

G1/4 thread

G1/2 thread

NPT 1/2 thread



Design	G1/4		G1/2			NPT1/2
Dimensions						
Detection range [cm/s]	water 1...150 / oil 3...300					
Output						
Sensor length L [mm]	25	30	48	80	120	40
Thread	G1/4	G1/2	G1/2	G1/2	G1/2	NPT1/2
ID-No.	P11064 *	P10521 *	P10523 *	P10525 *	P10526 *	P11066 *
Type	SC440/5-A4-GSP	SC440-A4-GSP	SC440/1-A4-GSP	SC440/2-A4-GSP	SC440/3-A4-GSP	SC440/6-A4-GSP
Supply voltage [V]	24 DC ±20%					
Current consumption [mA]	70					
Switching current [mA]	400 (20 °C)					
Ambient temperature [°C]	-20...+80					
Medium temperature [°C]	-20...+80					
Temperature gradient [K/min]	250					
Start-up time typ. [s]	8 (2...15)					
Reaction time typ. [s]	2 (1...13)					
Compressive strength [bar]	100					
Sensor material	AISI 316 Ti • different materials on request					
Housing material	Stainless steel					
Display flow	LED-array					
Protection [EN 60529]	IP 67					
Connection	M12 connector					
Accessories	connecting cable type SLG 3-2, SLG 3-5, SLW 3-2, SLW 3-5, see page 1.91					



Compact models DC • PNP output

Series SCS 440 - Flow controller

DC 24 V

Robust stainless steel housing

Plug-in installation

Easy configuration of the switching points

Can be used universally with an adapter



Design	SCS 440	
Dimensions		
Detection range	[cm/s]	water 1...150 / oil 3...300
Output		
Sensor length L	[mm]	47
Thread fixing nut		M18x1.5
ID-No.		P11352
Type		SCS 440-A4-GSP
Supply voltage	[V]	24 DC ±20%
Current consumption	[mA]	≤ 70
Switching current	[mA]	400
Ambient temperature	[°C]	-20...+80
Medium temperature	[°C]	-20...+80
Temperature gradient	[K/min]	250
Start-up time typ.	[s]	8 (2...15)
Reaction time typ.	[s]	2 (1...13)
Compressive strength	[bar]	100
Material		housing: AISI 316 L sensor: AISI 316 Ti
O-Ring-Material		FPM
Display flow		LED-array
Protection	[EN 60529]	IP 67
Connection		M12 connector

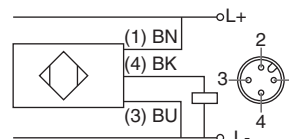

Accessories connecting cable type SLG, SLW (page 1.91), screw-in adapter SDA-SCS-... (page 1.95)

Compact models AC/DC • Plug-in installation

Series SNS 450 - Flow controller



AC 230 V • AC 115 V • DC 24 V

PNP output • Relay output

Connection thread M18x1,5

Can be used universally
with an adapter

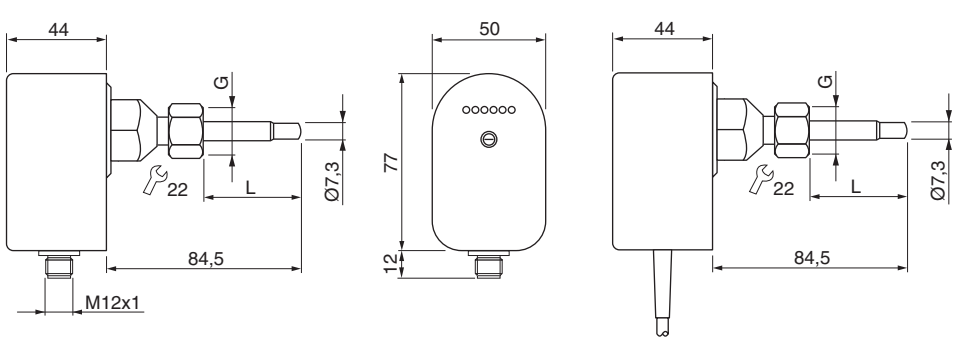

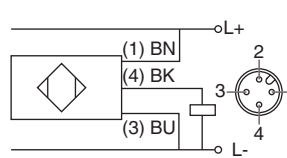
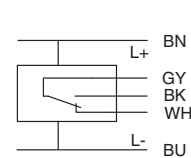
Design	M18x1.5			
Dimensions				
Detection range [cm/s]	water 1...150 / oil 3...300			
Output				
Sensor length L [mm]	47	47	47	47
Connection thread G	M18x1.5	M18x1.5	M18x1.5	M18x1.5
ID-No.	P11360*	P11362*	P11364*	P11365*
Type	SNS 450-A4-GSP-S	SNS 450-A4-GR	SNS 450-A4-WR2	SNS 450-A4-WR1
Supply voltage [V]	24 DC ±20%	24 DC ±20%	230 AC ±10%	115 AC ±10%
Current consumption [mA]	<100	<100	<35	<65
Switching voltage max. [V]	-	250 AC / 60 DC	250 AC / 60 DC	250 AC / 60 DC
Switching current max. [A]	0,4	4 AC / 4 DC	4 AC / 4 DC	4 AC / 4 DC
Switching power max.	-	1000 VA / 60 W	1000 VA / 60 W	1000 VA / 60 W
Ambient temperature [°C]	-20...+70			
Medium temperature [°C]	-20...+80			
Temperature gradient [K/min]	250			
Start-up time typ. [s]	8 (2...15)			
Reaction time typ. [s]	2 (1...13)			
Compressive strength [bar]	100			
Sensor material	AISI 316 Ti			
Housing material	PBT			
Display flow	LED array			
Protection [EN 60529]	IP 67			
Connection	M12 connector	2 m PVC-cable 5x0.5 mm ²		
				
Accessories	connecting cable type SLG, SLW (See 1.91), screw-in adapter SDA-SCS-... (page 1.95)			



Compact models DC • PNP output

Series SN 450 - Flow controller

DC 24 V

G1/2 thread

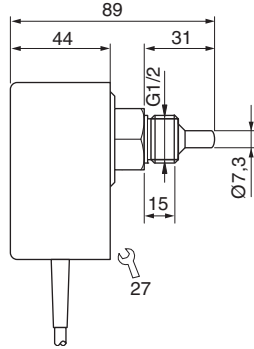
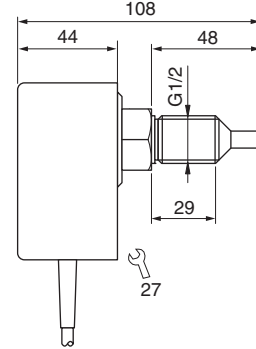

Design	G1/2 • L= 31 mm		G1/2 • L= 48 mm	
Dimensions				
Detection range [cm/s]	water 1...150 / oil 3...300			
Output				
Sensor length L [mm]	31	31	48	48
Thread	G1/2	G1/2	G1/2	G1/2
ID-No.	P11241 *	P11161 *	P11228 *	P11162 *
Type	SN 450-A4-GSP	SN 450-A4-GSP-S	SN 450/1-A4-GSP	SN 450/1-A4-GSP-S
Supply voltage [V]	24 DC ±20%			
Current consumption [mA]	60			
Switching current [mA]	400			
Ambient temperature [°C]	-20...+70			
Medium temperature [°C]	-20...+80			
Temperature gradient [K/min]	250			
Start-up time typ. [s]	8 (2...15)			
Reaction time typ. [s]	2 (1...13)			
Compressive strength [bar]	100			
Sensor material	AISI 316 Ti • different materials on request			
Housing material	PBT			
Display flow	LED-array			
Protection [EN 60529]	IP 67			
Connection	2 m PVC-cable 3x0.5 mm ²	M12 connector	2 m PVC-cable 3x0.5 mm ²	M12 connector

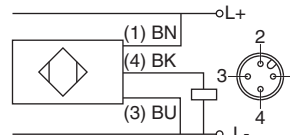

Accessories

connecting cable type SLG 3-2, SLG 3-5, SLW 3-2, SLW 3-5, see page 1.91

Compact models DC • Relay output

Series SN 450 - Flow controller

DC 24 V

G1/2 thread



Design	G1/2 • L= 31 mm		G1/2 • L= 48 mm	
Dimensions				
Detection range [cm/s]	water 1...150 / oil 3...300			
Output				
Sensor length L [mm]	31	31	48	48
Thread	G1/2	G1/2	G1/2	G1/2
ID-No.	P11115	P11116	P11078	P11086
Type	SN 450-A4-GR	SN 450-A4-GRS	SN 450/1-A4-GR	SN 450/1-A4-GRS
Supply voltage [V]	24 DC ±20%			
Current consumption [mA]	80			
Switching voltage [V]	250 AC / 60 DC			
Switching current [mA]	4 A AC / 4 A DC	2 A AC / 2 A DC	4 A AC / 4 A DC	2 A AC / 2 A DC
Switching power max.	1000 VA / 60 W	500 VA / 50 W	1000 VA / 60 W	500 VA / 50 W
Ambient temperature [°C]	-20...+70			
Medium temperature [°C]	-20...+80			
Temperature gradient [K/min]	250			
Start-up time typ. [s]	8 (2...15)			
Reaction time typ. [s]	2 (1...13)			
Compressive strength [bar]	100			
Sensor material	AISI 316 Ti • different materials on request			
Housing material	PBT			
Display flow	LED-array			
Protection [EN 60529]	IP 67			
Connection	2 m PVC-cable 5x0.5 mm ²	M12 connector	2 m PVC-cable 5x0.5 mm ²	M12 connector
Accessories	connecting cable type SLG 4-2, SLG 4-5, SLW 4-2, SLW 4-5, see page 1.91			

Compact models AC • Relay output



Series SN 450 - Flow controller

AC 230 V • 115 V

Relay output

G1/2 thread

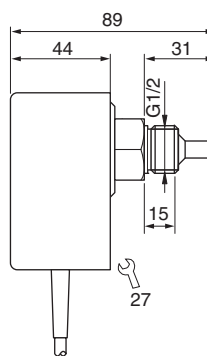
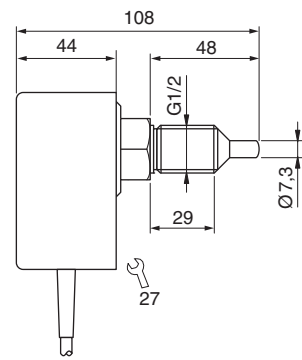

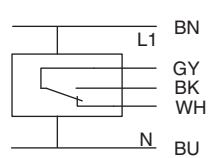
Design	G1/2 • L= 31 mm		G1/2 • L= 48 mm	
Dimensions				
Detection range [cm/s]	water 1...150 / oil 3...300			
Output				
Sensor length L [mm]	31	31	48	48
Thread	G1/2	G1/2	G1/2	G1/2
ID-No.	P11113	P11114	P11074	P11076
Type	SN 450-A4-WR1	SN 450-A4-WR2	SN 450/1-A4-WR1	SN 450/1-A4-WR2
Supply voltage [V]	115 AC ±15%	230 AC ±15%	115 AC ±15%	230 AC ±15%
Current consumption [mA]	60	30	60	30
Switching voltage [V]	250 AC / 60 DC			
Switching current [mA]	4 A AC / 4 A DC			
Switching power max.	1000 VA / 60 W			
Ambient temperature [°C]	-20...+70			
Medium temperature [°C]	-20...+80			
Temperature gradient [K/min]	250			
Start-up time typ. [s]	8 (2...15)			
Reaction time typ. [s]	2 (1...13)			
Compressive strength [bar]	100			
Sensor material	AISI 316 Ti • different materials on request			
Housing material	PBT			
Display flow	LED-array			
Protection [EN 60529]	IP 67			
Connection	2 m PVC-cable 5x0.5 mm ²			
				

Compact models AC/DC • Extra long

Series SN 450 - Flow controller

AC 230 V • AC 115 V

DC 24 V

Relay output

G1/2 thread

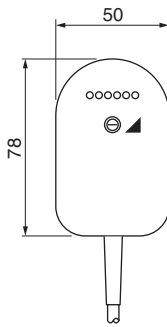
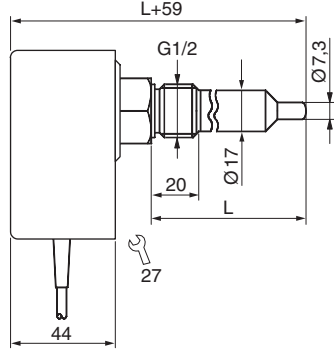
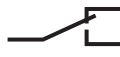
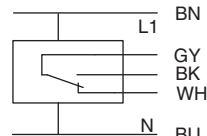
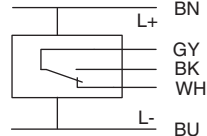

Design	G1/2 • L= 80 mm			G1/2 • L= 120 mm		
Dimensions						
Detection range [cm/s]	water 1...150 / oil 3...300					
Output						
Sensor length L [mm]	80	80	80	120	120	120
Thread	G1/2	G1/2	G1/2	G1/2	G1/2	G1/2
ID-No.	P11079	P11080	P11081	P11082	P11083	P11084
Type	SN450/2-A4-WR1	SN450/2-A4-WR2	SN450/2-A4-GR	SN450/3-A4-WR1	SN450/3-A4-WR2	SN450/3-A4-GR
Supply voltage [V]	115 AC ±15%	230 AC ±15%	24 DC ±20%	115 AC ±15%	230 AC ±15%	24 DC ±20%
Current consumption [mA]	60	30	80	60	30	80
Switching voltage [V]	250 AC / 60 DC					
Switching current [mA]	4 A AC / 4 A DC					
Switching power max.	1000 VA / 60 W					
Ambient temperature [°C]	-20...+70					
Medium temperature [°C]	-20...+80					
Temperature gradient [K/min]	250					
Start-up time typ. [s]	8 (2...15)					
Reaction time typ. [s]	2 (1...13)					
Compressive strength [bar]	100					
Sensor material	AISI 316 Ti • different materials on request					
Housing material	PBT					
Display flow	LED-array					
Protection [EN 60529]	IP 67					
Connection	2 m PVC-cable 5x0.5 mm ²					
						

Compact models DC • Plug-in installation

Series SNS 450 - Flow controller





DC 24 V

Analog output

Connection thread M18x1,5

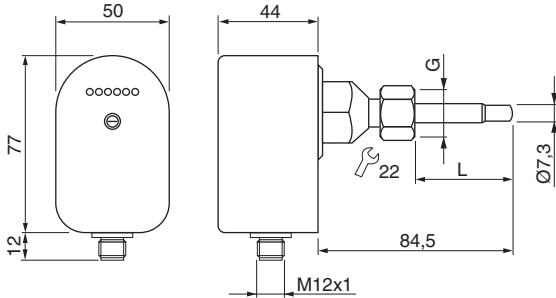
Can be used universally
with an adapter

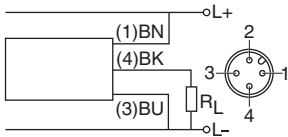

Design	M18x1.5		
Dimensions			
Detection range [cm/s]			
Water	5...150	5...300	1...150
Oil	-	-	3...300
Output			
Sensor length L	47	47	47
Connection thread G	M18x1.5	M18x1.5	M18x1.5
ID-No.	P11357*	P11358*	P11359*
Type	SNS 450 GA	SNS 450 GA-3M	SNS 450 GAN-S
Current output	4...20 mA, linear	4...20 mA, linear	4..20 mA, non linear
Supply voltage [V]		24 DC ±10%	
Current consumption [mA]		<100	
Load R _L [Ω]		200...500	
Ambient temperature [°C]		-20...+70	
Medium temperature [°C]		-20...+80	
Start-up time typ. [s]		8...60	
Reaction time typ. [s]		3	
Compressive strength [bar]		100	
Sensor material		AISI 316 Ti	
Housing material		PBT	
Display flow		LED array	
Protection [EN 60529]		IP 67	
Connection		M12 connector	
			
Accessories	connecting cable type SLG, SLW (page 1.91), screw-in adapter SDA-SCS-... (page 1.95)		

Compact models DC • Analog output

Series SN 450 - Flow controller

DC 24 V

G1/2 thread

Analog output linear

Analog output non linear



Design	G1/2 • L= 31 mm		G1/2 • L= 48 mm		
Dimensions					
Detection range [cm/s]	5...150	5...300	5...150	5...300	5...150
Output					
Sensor length L [mm]	31	31	48	48	48
Thread	G1/2	G1/2	G1/2	G1/2	G1/2
ID-No.	P11121 *	P11118 *	P11095 *	P11122 *	P11239 *
Type	SN 450 GA	SN 450 GA-3M	SN 450/1 GA	SN 450/1 GA-3M	SN 450/1 GAN-S
Output	linear for water				non linear
Current output [mA]	4..20				4..20
Current consumption [mA]	<100				
Supply voltage [V]	24 DC ±10 %				
Load R _L [Ω]	200...500				
Ambient temperature [°C]	-20...+70				
Medium temperature [°C]	-20...+80				
Start-up time [s]	approx. 8				
Reaction time typ. [s]	3				
Compressive strength [bar]	100				
Sensor material	AISI 316 Ti • different materials on request				
Housing material	PBT				
Display flow	LED-array				
Protection [EN 60529]	IP 65				
Connection	M12 connector				

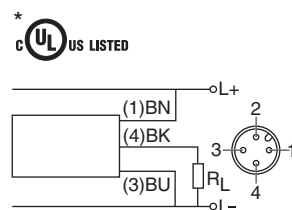
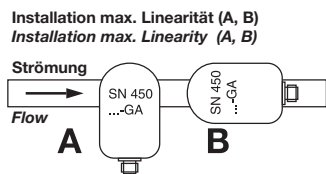

- LED display**
- red = 4 mA
 - 1. green > 4 mA
 - 2. green > 8 mA
 - 3. green > 12 mA
 - 4. green > 16 mA
 - 5. green = 20 mA

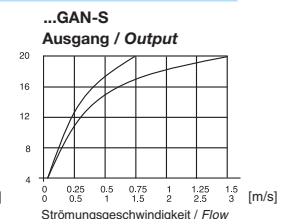
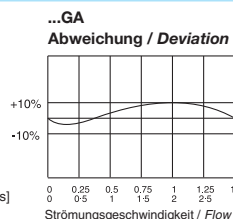
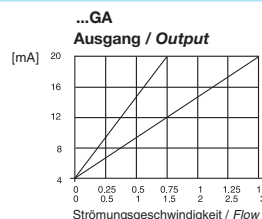

Accessories

connecting cable type SLG 3-2 (Z01076), see page 1.91

Compact models DC • Two switching points

Series SN 450 - Flow controller

DC 24 V

PNP output

G1/2 thread

Two independent switching points



Design

G1/2 • L= 31 mm

Dimensions

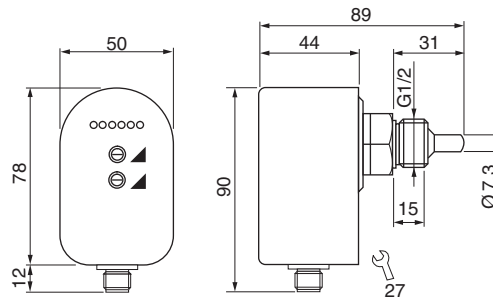

Detection range	[cm/s]	water 1...150 / oil 3...300
Output		
Sensor length L	[mm]	31
Thread		G1/2
ID-No.		P11264 *
Type		SN 450 GPP
Supply voltage	[V]	24 DC ±20%
Current consumption	[mA]	100
Switching current	[mA]	200
Ambient temperature	[°C]	-20...+60
Medium temperature	[°C]	-20...+80
Temperature gradient	[K/min]	250
Start-up time typ.	[s]	1...15
Compressive strength	[bar]	100
Sensor material		AISI 316 Ti • different materials on request
Housing material		PBT
Display flow		LED-array
Protection	[EN 60529]	IP 67
Connection		M12 connector

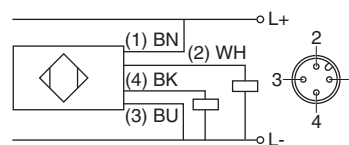

Accessories

connecting cable type SLG 4-2 (Z00445), see page 1.91

Compact models DC • Temperature control

Series SNT 450 - Flow controller

DC 24 V
PNP output

G1/2 thread



Design	G1/2 • L= 31 mm		G1/2 • L= 48 mm	
Dimensions				
Detection range [cm/s]	water 1...150 / oil- 3...300			
Output				
Sensor length L [mm]	31	31	48	48
Temperature [°C]	0...+80	0...+80	0...+80	0...+80
ID-No.	P11218*	P11219*	P11224*	P11225*
Type	SNT 450-A4-GSP	SNT 450-A4-GSP-S	SNT 450/1-A4-GSP	SNT 450/1-A4-GSP-S
Supply voltage [V]	24 DC ±20%			
Current consumption [mA]	60			
Switching current [mA]	400 (25 °C)			
Ambient temperature [°C]	-20...+70			
Medium temperature [°C]	-20...+80			
Temperature gradient [K/min]	250			
Start-up time typ. [s]	8 (2...15)			
Reaction time typ. [s]	2 (1...13)			
Compressive strength [bar]	100			
Sensor material	AISI 316 Ti • different materials on request			
Housing material	PBT			
Display flow	LED-array			
Protection [EN 60529]	IP 65			
Connection	2 m PVC-cable 4x0.5 mm ²	M12 connector	2 m PVC-cable 4x0.5 mm ²	M12 connector
* US LISTED				
Accessories	connecting cable type SLG 4-2, SLG 4-5, SLW 4-2, SLW 4-5, see page 1.91			

Compact models DC • Temperature control

Series SNT 450 - Flow controller

DC 24 V

Relay output

G1/2 thread



Design	G1/2 • L= 31 mm		G1/2 • L= 48 mm	
Dimensions				
Detection range [cm/s]	water 1...150 / oil 3...300			
Output				
Sensor length L [mm]	31	31	48	48
Temperature [°C]	0...+80	0...+80	0...+80	0...+80
ID-No.	P11216	P11217	P11222	P11223
Type	SNT 450-A4-GR	SNT 450-A4-GR-S	SNT 450/1-A4-GR	SNT 450/1-A4-GR-S
Supply voltage [V]	24 DC ±20%	24 DC ±20%	24 DC ±20%	24 DC ±20%
Current consumption [mA]	80	80	80	80
Switching voltage [V]	250 AC / 60 DC	30 AC / 36 DC	250 AC / 60 DC	30 AC / 36 DC
Switching current [mA]	2A AC / 2A DC	1A AC / 1A DC	2A AC / 2A DC	1A AC / 1A DC
Switching power max.	500 VA / 60 W	-	500 VA / 60 W	-
Ambient temperature [°C]	-20...+70			
Medium temperature [°C]	-20...+80			
Temperature gradient [K/min]	250			
Start-up time typ. [s]	8 (2...15)			
Reaction time typ. [s]	2 (1...13)			
Compressive strength [bar]	100			
Sensor material	AISI 316 Ti • different materials on request			
Housing material	PBT			
Display flow	LED-array			
Protection [EN 60529]	IP 65			
Connection	2 m PVC-cable 6x0.5 mm ²	M12 connector	2 m PVC-cable 6x0.5 mm ²	M12 connector
Accessories	connecting cable type SLG 5-2, SLW 5-2, see page 1.91			

Compact models AC • Temperature control



Series SNT 450 - Flow controller

AC 230 V • 115 V

Relay output

G1/2 thread

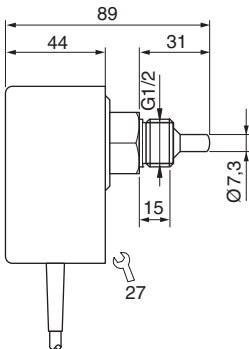
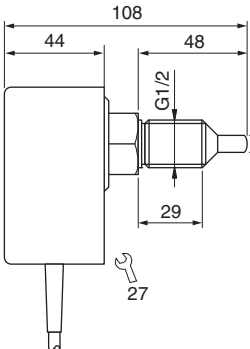

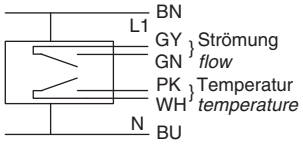
Design	G1/2 • L= 31 mm		G1/2 • L= 48 mm	
Dimensions				
Detection range [cm/s]	water 1...150 / oil 3...300			
Output				
Sensor length L [mm]	31	31	48	48
Temperature [°C]	0...+80	0...+80	0...+80	0...+80
ID-No.	P11214	P11215	P11220	P11221
Type	SNT 450-A4-WR1	SNT 450-A4-WR2	SNT 450/1-A4-WR1	SNT 450/1-A4-WR2
Supply voltage [V]	115 AC ±15%	230 AC ±15%	115 AC ±15%	230 AC ±15%
Current consumption [mA]	60	30	60	30
Switching voltage [V]	250 AC / 60 DC			
Switching current [A]	2 AC / 2 DC			
Switching power max.	500 VA / 60 W			
Ambient temperature [°C]	-20...+70			
Medium temperature [°C]	-20...+80			
Temperature gradient [K/min]	250			
Start-up time typ. [s]	8 (2...15)			
Reaction time typ. [s]	2 (1...13)			
Compressive strength [bar]	100			
Sensor material	AISI 316 Ti • different materials on request			
Housing material	PBT			
Display flow	LED-array			
Protection [EN 60529]	IP 65			
Connection	2 m PVC-cable 6x0.5 mm ²			
				

Compact models AC/DC • Turn on/off delay

Series SN 450 - Flow controller



DC 24 V

AC 230 V

Relay output

G1/2 thread

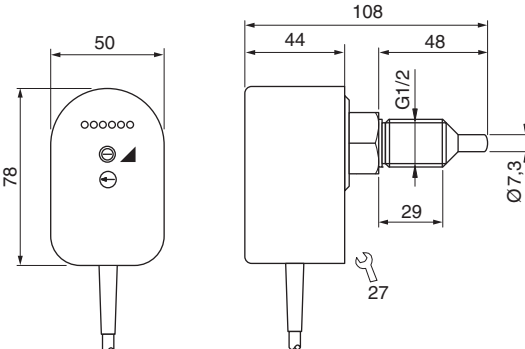

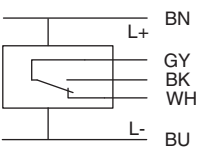
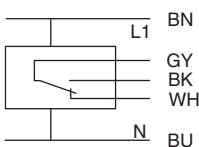
Design	Turn on delay		Turn off delay	
Dimensions				
Detection range [cm/s]	water 1...150 / oil 3...300			
Output				
ID-No.	P11234		P11233	
Type	SN 450/1 GR-VE		SN 450/1 GR-VA	
			SN 450/1 WR2-VA	
Turn on delay [s]	0...25		-	
Turn off delay [s]	-		0...25	
Supply voltage [V]	24 DC ±20%		230 AC ±15%	
Current consumption [mA]	80		30	
Switching voltage [V]			250 AC / 60 DC	
Switching current [A]			2 AC / 2 DC	
Switching power max.			500 VA / 60 W	
Ambient temperature [°C]			-20...+70	
Medium temperature [°C]			-20...+80	
Temperature gradient [K/min]			250	
Start-up time typ. [s]			8 (2...15)	
Reaction time typ. [s]			2 (1...13)	
Compressive strength [bar]			100	
Sensor material	AISI 316 Ti • different materials on request			
Housing material	PBT			
Display flow	LED-array			
Protection [EN 60529]	IP 65			
Connection	2 m PVC-cable, 5x0.5 mm ²			
				

Inline-Sensor

Series SD

G1/4 thread • Ø4 mm

G1/4 thread • Ø9 mm



Design	G1/4 • Ø4 mm	G1/4 • Ø9 mm
Dimensions		
Detection range [l/min]	0.001...1	0.01...6
Working range [l/min]	0.01...0,8	0.2...6
Inner diameter d [mm]	4	9
Maximum flow [l/h]	300	1800
ID-No.	P11251	P11252
Type	SD 504 S	SD 510 S
Ambient temperature [°C]	-20...+70	
Medium temperature [°C]	0...+80	
Temperature gradient [K/min]	400	
Start-up time [s]	5	
Reaction time typ. [s]	1	
Compressive strength [bar]	20	
Display flow	-	
Material	housing: PBT sensor: AISI 316 Ti	
Protection [EN 60529]	IP 67	
Connection	M12 connector	

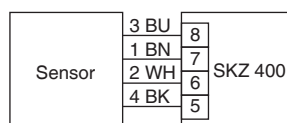
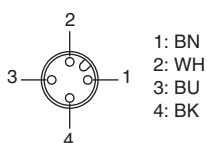

Amplifiers required: SKZ..., SKM..., see page 1.62 / 1.64
(Temperature control with this sensor is not possible)

Accessories connecting cable type SLG 4-2 (Z00445), see page 1.91

Inline-Compact • up to 6 l/min

Series SDN - Flow controller

DC 24 V
PNP output
Relay output
Analog output

G1/4 thread • Ø4 mm
G1/4 thread • Ø9 mm



Design	G1/4 • Ø4 mm			G1/4 • Ø9 mm		
Dimensions						
Detection range [l/min]	0.001...1			0.01...6		
Working range [l/min]	0.015...1			0.1...6		
Inner diameter d [mm]	4			9		
Maximum flow [l/h]	300			1800		
Output						
ID-No.	P11247*	P11271	P11249*	P11248*	P11273	P11250*
Type	SDN 504 GSP	SDN 504 GR	SDN 504 GA	SDN 510 GSP	SDN 510 GR	SDN 510 GA
Switching current [mA]	200	1000	-	200	1000	-
Switching voltage [V]	-	30 AC/36 DC	-	-	30 AC/36 DC	-
Load RL [Ω]	-	-	200...500	-	-	200...500
Supply voltage [V]	24 DC ±10%					
Current consumption [mA]	<50					
Ambient temperature [°C]	0...+60					
Medium temperature [°C]	0...+80					
Temperature gradient [K/min]	400					
Start-up time typ. [s]	5...15					
Reaction time typ. [s]	0.5...1					
Compressive strength [bar]	20					
Display flow	LED-array					
Material	housing: PBT sensor: AISI 316 Ti					
Protection [EN 60529]	IP 67					
Connection	M12 connector					
* US LISTED						
Accessories	connecting cable type SLG, SLW, SBG, SBW, see page 1.91					

Inline-Compact • up to 40 l/min

Series SDN - Flow controller

DC 24 V
PNP output
Relay output
Analog output

G1/2 thread • Ø 15 mm
G3/4 thread • Ø 19 mm



Design	G1/2 • Ø 15 mm			G3/4 • Ø 19 mm		
Dimensions						
Detection range [l/min]	2...25			3...40		
Working range [l/min]	3...20			4...30		
Inner diameter d [mm]	15			19		
Maximum flow [l/h]	4000			7500		
Output						
ID-No.	P11284 *	P11288	P11286 *	P11285 *	P11289	P11287 *
Type	SDN 515 GSP	SDN 515 GR	SDN 515 GA	SDN 520 GSP	SDN 520 GR	SDN 520 GA
Switching current [mA]	200	1000	-	200	1000	-
Switching voltage [V]	-	30 AC/36 DC	-	-	30 AC/36 DC	-
Load R _L [Ω]	-	-	200...500	-	-	200...500
Supply voltage [V]	24 DC ±10%					
Current consumption [mA]	<60					
Ambient temperature [°C]	0...+60					
Medium temperature [°C]	0...+80					
Temperature gradient [K/min]	400					
Start-up time typ [s]	5...15					
Reaction time typ [s]	0.5...3					
Compressive strength [bar]	20					
Display flow	LED-array					
Material	housing: PBT sensor: AIS 316 Ti / FPM					
Protection [EN 60529]	IP 67					
Connection	M12 connector					
* US LISTED						
Accessories	connecting cable type SLG, SLW, SBG, SBW, see page 1.91					

Inline-Compact • Micro flow

Series SDN - Flow controller

DC 24 V

PNP output • Relais output

Analog output

G1/4 thread

Fast reaction time - high sensitivity

Detection of micro flow pulses



Design	G1/4 Pulse detection		G1/4		
Dimensions					
Detection range [ml/min]	from 0.02 ml / 100 ms		0.1...500		
Working range [ml/min]	from 0.04 ml / 100 ms		1...200		
Inner diameter d [mm]	4		3.6		
Maximum flow [l/h]	300		100		
Output	 PNP		 PNP	 Relay	 4...20 mA, non linear
ID-No.	P11256 *		P11329 *	P11330	P11331 *
Type	SDN 504 GSP-DYN		SDN 503/1 GSP	SDN 503/1 GR	SDN 503/1 GA
Switching current [mA]	200		200	1000	-
Switching voltage [V]	-		-	30 AC / 36 DC	-
Load R _L [Ω]	-		-	-	200...500
Supply voltage [V]	24 DC ±10%		24 DC ±10%		
Current consumption [mA]	<50		<50		
Ambient temperature [°C]	0...+60		0...+60		
Medium temperature [°C]	-20...+80		0...+60		
Temperature gradient [K/min]	-		400 (min. 100 ml/min)		
Start-up time [s]	5...15		5...20		
Reaction time [s]	<0.1		0.5...3		
Compressive strength [bar]	20		10		
Display flow	LED				
Material	housing: PBT sensor: AISI 316 Ti				
Protection [EN 60529]	IP 67				
Connection	M12 connector				
* 	The SDN 504 GSP-DYN detects increasing in flow. The switch-off delay is adjustable between 0.5...10 s.				
Accessories	connecting cable type SLG, SLW, SBG, SBW, see page 1.91				

Inline-Compact • Micro flow

Series SDN - Flow controller

DC 24 V

PNP output • Relais output

Analog output

Ø4 mm

Ø6 mm for tube fittings

Fast reaction time - high sensitivity



Design	Tube connection Ø4 mm			Tube connection Ø6 mm		
Dimensions						
Detection range [ml/min]	0.1...500					
Working range [ml/min]	1...200					
Diameter [mm]	inner diameter 3.6, outer diameter 4.0			inner diameter 3.6, outer diameter 6.0		
Maximum flow [l/h]	100			100		
Output	PNP	Relay	4...20 mA	PNP	Relay	4...20 mA
ID-No.	P11265 *	P11277	P11266 *	P11332 *	P11333	P11334 *
Type	SDN 503 GSP	SDN 503 GR	SDN 503 GA	SDN 503/2 GSP	SDN 503/2 GR	SDN 503/2 GA
Switching current [mA]	200	1000	-	200	1000	-
Switching voltage [V]	-	30 AC / 36 DC	-	-	30 AC / 36 DC	-
Load R _L [Ω]	-	-	200...500	-	-	200...500
Supply voltage [V]	24 DC ±10%					
Current consumption [mA]	< 50					
Ambient temperature [°C]	0...+60					
Medium temperature [°C]	0...+60					
Temperature gradient [K/min]	400 (min. 100 ml/min)					
Start-up time [s]	5...20					
Reaction time typ. [s]	0.5...3					
Compressive strength [bar]	1			10		
Display flow	LED-array					
Material	housing: PBT sensor: AISI 316 Ti					
Protection [EN 60529]	IP 67					
Connection	M12 connector					
* US LISTED						
Accessories	connecting cable type SLG, SLW, SBG, SBW, see page 1.91					

Inline-Compact

Series SDNC 503

DC 24 V

Flow monitoring

Can be easily integrated in the tubing
Immediately ready for use – no adjustment



Design	G1/4 • Ø3.6 mm			
Dimensions				
Switching point	[l/min]	water 0.5	water 1.0	water 1.5
Inner diameter D	[mm]	3.6	3.6	3.6
Output		PNP	PNP	PNP
ID-No.		P11338	P11340	P11341
Type		SDNC 503 GSP-05	SDNC 503 GSP-10	SDNC 503 GSP-15
Supply voltage	[V]	24 DC ±10%		
Current consumption	[mA]	≤ 70		
Switching current	[mA]	200		
Ambient temperature	[°C]	0...+60		
Medium temperature	[°C]	0...+60		
Reaction time typ.	[s]	1 (0.5...10)		
Compressive strength	[bar]	10		
Sensor material		AISI 316 Ti		
Housing material		PBT-GF30		
Protection	[EN 60529]	IP 67		
Connection		M12 connector		
Accessories		connecting cable type SLW 3-2-LED, see page 1.91		

Inline-Compact

Series SDNC 503

DC 24 V

Flow monitoring of
50 up to 2000 ml/min

Can be easily integrated in the tubing
Immediately ready for use – no adjustment



Design **G1/4 • Ø3.6 mm**

Dimensions

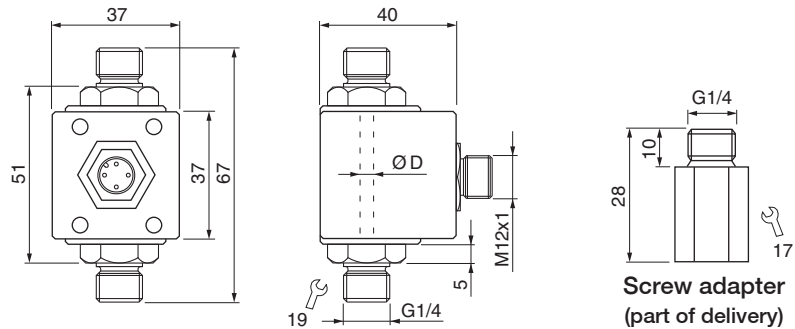

Detection range	[l/min]	water 0.05...1.0	water 0.2...2.0	water 0.05...1.0	water 0.2...2.0
Inner diameter D	[mm]	3.6	3.6	3.6	3.6
Output		4...20 mA, linear	4...20 mA, linear	pulse, linear	pulse, linear
ID-No.		P11342	P11343	P11344	P11345
Type		SDNC 503 GA-10	SDNC 503 GA-20	SDNC 503 GP-10	SDNC 503 GP-20
Supply voltage	[V]	24 DC ±10%			
Current consumption	[mA]	≤ 70			
Load R _L	[Ω]	200...500	200...500	≥ 1000	≥ 1000
Pulse output	[ml/Puls]	-	-	1	1
Ambient temperature	[°C]	0...+60			
Medium temperature	[°C]	0...+60			
Reaction time typ.	[s]	1 (0.5...10)			
Compressive strength	[bar]	10			
Sensor material		AISI 316 Ti			
Housing material		PBT-GF30			
Protection	[EN 60529]	IP 67			

Connection **M12 connector**



Accessories **connecting cable type SLG, SLW, see page 1.91**

Special-Probe • Food • Pharma

Series SCB / STB / STC

DC 24 V
PNP output

Triclamp compact
Triclamp Ø50,5
DIN 11851



Design	Triclamp compact	Triclamp Ø50,5	DIN 11851
Dimensions			
Detection range [cm/s]			
Water	1...150	1...150	1...150
Oil	3...300	3...300	3...300
Output			
Connecting diameter DN	Ø50.5 mm	Ø50.5 mm	DN 25
ID-No.	P11156	P11060	P10632
Type	SCB 450 GSP	STB 450 K	STC 425 K
Surface roughness [µm]	<0.8		<0.8
Supply voltage [V]	24 DC ±20%		-
Current consumption [mA]	<70		-
Switching current [mA]	200		-
Voltage drop [V]	<2		-
Ambient temperature [°C]	-20...+80		-20...+80
Medium temperature [°C]	-20...+80 (100)*		+20...+120
Temperature gradient [K/min]	250		250
Start-up time [s]	8...15		2...15
Reaction time typ. [s]	2		2
Compressive strength [bar]	100		100
Housing material	1.4404		1.4404 / PVDF (cable gland)
Protection [EN 60529]	IP 67		IP 68
Connection	M12 connector		2 m FEP-cable 4x0.25 mm ²
*The Sensor may, for example during the cleaning process (CIP), be heated to 100 °C for a period of 10 minutes without being damaged. In this case, the switching point is not specified.			
Accessories	conn. cable SLG, SLW		amplifiers: SKM..., SKZ..., see page 1.62 - 1.64

Inline-Compact • Food • Pharma

Series SDB - Flow controller

DC 24 V
PNP output
Relay output
Analog output

Triclamp connection Ø34 mm
Inner diameter Ø10 mm



Design	Triclamp • Ø10 mm		
Dimensions			
Detection range [l/min]	0.01...6		
Working range [l/min]	0.1...6		
Inner diameter [mm]	10		
Maximum flow [l/h]	1800		
Output			
ID-No.	P11258 *	P11279	P11280 *
Type	SDB 510 GSP	SDB 510 GR	SDB 510 GA
Switching current [mA]	200	1000	-
Switching voltage [V]	-	30 AC / 36 DC	-
Load R _L [Ω]	-	-	200...500
Supply voltage [V]	24 DC ±10%		
Current consumption [mA]	<50		
Ambient temperature [°C]	0...+60		
Medium temperature [°C]	-20...+80	-20...+80	-20...+60
Temperature gradient [K/min]	400		
Start-up time typ. [s]	5...15		
Reaction time typ. [s]	0.5...1		
Compressive strength [bar]	20		
Display flow	LED-array		
Material	housing: PBT sensor: 1.4404		
Protection [EN 60529]	IP 67		
Connection	M12 connector		
* US LISTED			
Accessories	connecting cable type SLG, SLW, SBG, SBW, see page 1.91		

Inline-Compact • Ceramic • Chemical





Series SDN - Flow controller

DC 24 V
PNP output
Relay output
Analog output

G1/4 thread • Ø6 mm

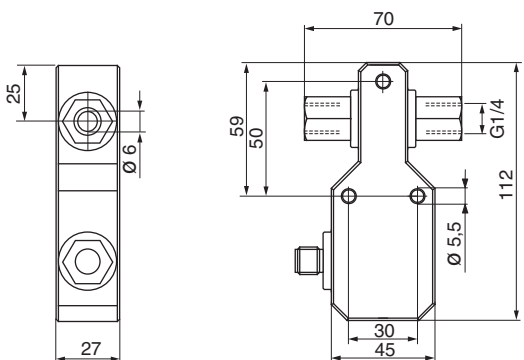
Ceramic measuring cell • Metal free

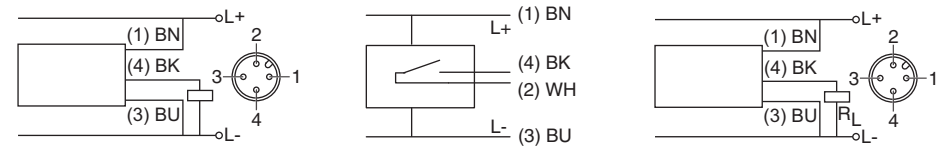

Design	G1/4 • Ø6 mm		
Dimensions			
Detection range [l/min]	0.005...3		
Working range [l/min]	0.02...3		
Inner diameter [mm]	6		
Maximum flow [l/h]	300		
Output			
ID-No.	P11262 *	P11275	P11263 *
Type	SDN 506 GSP-CER	SDN 506 GR-CER	SDN 506 GA-CER
Switching current [mA]	200	1000	-
Switching voltage [V]	-	30 AC / 36 DC	-
Load R _L [Ω]	-	-	200...500
Supply voltage [V]	24 DC ±10%		
Current consumption [mA]	<50		
Ambient temperature [°C]	0...+60		
Medium temperature [°C]	0...+60		
Temperature gradient [K/min]	400		
Start-up time [s]	5...15		
Reaction time typ. [s]	0.5...3		
Compressive strength [bar]	5		
Display flow	LED-array		
Material	housing: PBT sensor: AL ₂ O ₃ / PTFE / FPM (different materials on request)		
Protection [EN 60529]	IP 67		
Connection	M12 connector		
*  US LISTED			
Accessories	connecting cable type SLG, SLW, SBG, SBW, see page 1.91		

Inline-Compact • Temperature control

Serie SDTN - Flow controller

DC 24 V
PNP output

G1/4 thread • Ø4 mm
G1/4 thread • Ø9 mm
G1/2 thread • Ø15 mm



Design		G1/4 • Ø4 mm	G1/4 • Ø9 mm	G1/2 • Ø15 mm
Dimensions				
Detection range	[l/min]	0.001...1	0.01...6	2...25
Working range	[l/min]	0.015...1	0.1...6	3...20
Innder diameter d	[mm]	4	9	15
Maximum flow	[l/h]	300	1800	4000
Temperature	[°C]	0...+80	0...+80	0...+80
Output		PNP	PNP	PNP
ID-No.		P11326 *	P11327 *	P11328 *
Type		SDTN 504 GSP	SDTN 510 GSP	SDTN 515 GSP
Switching current	[mA]	200		
Switching voltage	[V]	-		
Supply voltage	[V]	24 DC ±10%		
Current consumption	[mA]	< 60		
Ambient temperature	[°C]	0...+60		
Medium temperature	[°C]	0...+80		
Start-up time typ.	[s]	5...15		
Reaction time typ.	[s]	0.5...3		
Compressive strength	[bar]	20		
Display flow / temp.		LED-array		
Material		housing: PBT sensor: AISI 316 Ti		
Protection	[EN 60529]	IP 67		
Connection		M12 connector		
* US LISTED		<p>(1) BN (2) WH (3) BU (4) BK</p> <p>(4) BK: Strömung (2) WH: Temperatur</p>		
Accessories		connecting cable type SLG 4-2, SLG 4-5, SLW 4-2, SLW 4-5, see page 1.91		

Inline-Compact • Digital display • 40 l/min





Series SDN - Flow controller

Flow- and temperature monitoring
of water and water-glycol mixtures

Programmable

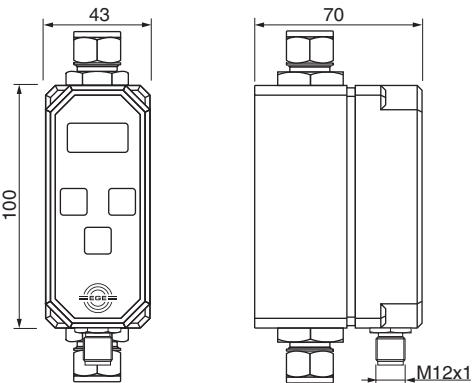
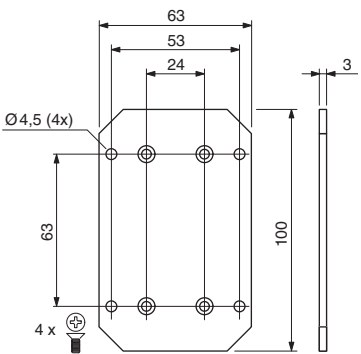
2x PNP output
Analog output

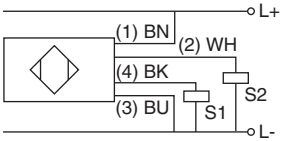
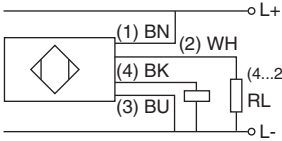

Design	SDN 552... GPP			SDN 552... GAPP		
Dimensions				 <p>Optional: mounting plate (Z01178)</p>		
Medium	water / glycol (0, 5, ..., 25, 30%)					
Working range [l/min]	1...10	2...20	4...40	1...10	2...20	4...40
Outer diameter pipe [mm]	10	15	18	10	15	18
Pipe connection	tube fittings for steel tubes according to DIN 2391 / ISO 3304					
Output	 2x PNP NC / NO, progr.			 +  4...20 mA, linear		
ID-No.	P11293	P11294	P11295	P11296	P11297	P11298
Type	SDN 552/1 GPP	SDN 552/2 GPP	SDN 552/3 GPP	SDN 552/1 GAPP	SDN 552/2 GAPP	SDN 552/3 GAPP
Supply voltage [V]	24 DC ±10%			24 DC ±10%		
Current consumption [mA]	<100			<100		
Switching current [mA]	200			200		
Load R _L [Ω]	-			200...500		
Ambient temperature [°C]	0...+60					
Medium temperature [°C]	-10...+90					
Temperature gradient [K/min]	400					
Start-up time [s]	6...10					
Reaction time [s]	1...8					
Programmable functions	switching point, hysteresis, switching output, time on/off delay, glycol percentage, adjustable to reference, averaging, access code					
Temperature control [°C]	-10...90, alternative switching point					
Compressive strength [bar]	20					
Material	housing: PBT sensor: AISI 316 Ti / FKM					
Protection [EN 60529]	IP 65					
Connection	M12 connector					
						
Accessories	mounting plate, connecting cable type SLG, SLW (page 1.91), adapter G1/2, adapter G1/4 (page 1.95)					

Inline-Compact • Digital display

Series SDN - Flow controller

Flow: 50 to 1000 ml/min

Temperature: 0 to 60 °C

Programmable

Switching output

Linear analog output



Design	SDN 552/5 GPP	SDN 552/5 GAPP	SDN 552/5 GAA
Dimensions			<p>Screw adapter (part of delivery)</p>
Medium	water		
Working range [ml/min]	50...1000		
Inner diameter D [mm]	3,6		
Output 1	PNP NC / NO, progr.	PNP NC / NO, progr.	4...20 mA, linear
Output 2	PNP NC / NO, progr.	4...20 mA, linear	4...20 mA, linear
ID-No.	P11346	P11348	P11350
Type	SDN 552/5 GPP	SDN 552/5 GAPP	SDN 552/5 GAA
Supply voltage [V]	24 DC ±10%		
Switching current [mA]	200	200	-
Load RL [Ω]	-	200...500	200...500
Current consumption [mA]	≤100		
Ambient temperature [°C]	0...+60		
Medium temperature [°C]	0...+60		
Start-up time [s]	6...10		
Reaction time [s]	1...8		
Programmable functions	switching point, hysteresis, NC/NO, time on / off delay, adjustable to reference, analog range, averaging, access code		
Compressive strength [bar]	10		
Material	housing: PBT-GF30 sensor: AISI 316 Ti / FKM		
Protection [EN 60529]	IP 65		
Connection	M12 connector		
Accessories	mounting plate (Z01178), connecting cable type SLG, SLW, page 1.91		

Inline-Compact • Digital display

Series SDN - Flow controller

Flow: 100 to 2000 ml/min

Temperature: 0 to 60 °C

Programmable

Switching output

Linear analog output



Design	SDN 552/6 GPP	SDN 552/6 GAPP	SDN 552/6 GAA
Dimensions	<p>Screw adapter (part of delivery)</p>		
Medium	water		
Working range [ml/min]	100...2000		
Inner diameter D [mm]	5,6		
Output 1	PNP NC / NO, progr.	PNP NC / NO, progr.	4...20 mA, linear
Output 2	PNP NC / NO, progr.	4...20 mA, linear	4...20 mA, linear
ID-No.	P11347	P11349	P11351
Type	SDN 552/6 GPP	SDN 552/6 GAPP	SDN 552/6 GAA
Supply voltage [V]	24 DC ±10%		
Switching current [mA]	200	200	-
Load RL [Ω]	-	200...500	200...500
Current consumption [mA]	≤100		
Ambient temperature [°C]	0...+60		
Medium temperature [°C]	0...+60		
Start-up time [s]	6...10		
Reaction time [s]	1...8		
Programmable functions	switching point, hysteresis, NC/NO, time on / off delay, adjustable to reference, analog range, averaging, access code		
Compressive strength [bar]	10		
Material	housing: PBT-GF30 sensor: AISI 316 Ti / FKM		
Protection [EN 60529]	IP 65		
Connection	M12 connector		
Accessories	mounting plate (Z01178), connecting cable type SLG, SLW, see page 1.91		

Inline-Compact • Digital display • 100 l/min



Series SDN - Flow controller

Flow and temperature monitoring

Programmable

Analog outputs
flow and temperature

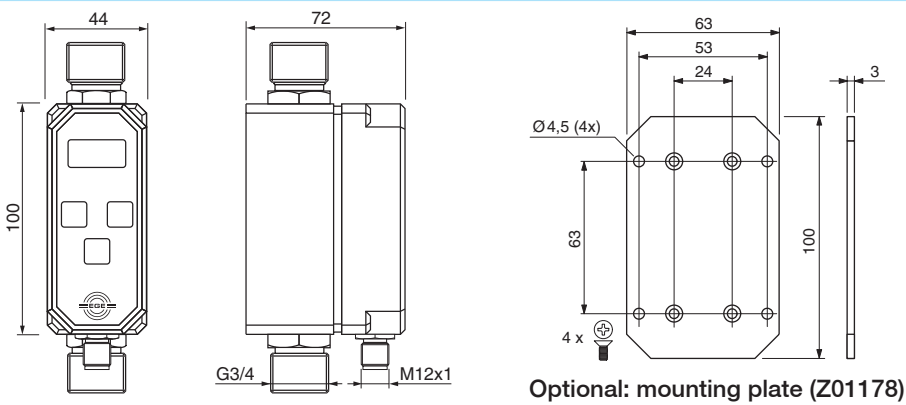

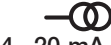
Design	SDN 552/4 GAA	
Dimensions	 <p>Optional: mounting plate (Z01178)</p>	
Medium	water	
Detection range	flow water: 10...100 l/min temperature: 0...+90 °C	
Connection	G3/4	
Output	flow:  4...20 mA, linear	temperature:  4...20 mA, linear
ID-No.	P11335	
Type	SDN 552/4 GAA	
Load R_L [Ω]	200...500	
Supply voltage [V]	24 DC $\pm 10\%$	
Current consumption [mA]	100	
Ambient temperature [$^{\circ}\text{C}$]	0...+60	
Medium temperature [$^{\circ}\text{C}$]	0...+90	
Temperature gradient [K/min]	400	
Start-up time [s]	6...10	
Reaction time [s]	1...8	
Programmable functions	adjustable to reference, averaging display flow / temperature, access code	
Compressive strength [bar]	20	
Material	housing: PBT sensor: AISI 316 Ti / FKM	
Protection [EN 60529]	IP 65	
Connection	M12 connector	

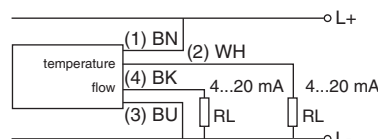

Accessories mounting plate (Z01178), connecting cable type SLG, SLW, see page 1.91

Inline-Compact • Digital display

Series SDN - Flow controller

Flow- and temperature monitoring
of water and water-glycol mixtures

Programmable

Analog / temperature output

2x PNP output flow

2x PNP output temperature



Design	SDN 554... GPP			SDN 552... GAA		
Dimensions						
Medium	water / glycol (0, 5, ..., 25, 30%)					
Working range [l/min]	1...10	2...20	4...40	1...10	2...20	4...40
Outer diameter pipe [mm]	10	15	18	10	15	18
Pipe connection	tube fittings for steel tubes according to DIN 2391 / ISO 3304					
Output flow	2x PNP NC / NO, progr.			4...20 mA, linear		
Output temperature	2x PNP NC / NO, progr.			4...20 mA, linear		
ID-No.	P11313	P11314	P11315	P11316	P11317	P11318
Type	SDN 554/1 GPP	SDN 554/2 GPP	SDN 554/3 GPP	SDN 552/1 GAA	SDN 552/2 GAA	SDN 552/3 GAA
Supply voltage [V]	24 DC ±10%			24 DC ±10%		
Current consumption [mA]	<100			<100		
Switching current [mA]	100			-		
Load R _L [Ω]	-			200...500		
Ambient temperature [°C]	0...+60			-		
Medium temperature [°C]	-10...+90			-		
Temperature gradient [K/min]	400			-		
Start-up time [s]	6...10			-		
Reaction time [s]	1...8			-		
Programmable functions	glycol percentage, adjustable to reference, averaging, access code. only SDN 554: switching point, hysteresis, switching output, time on/off delay.					
Temperature control [°C]	-9,8...90, 2 switching points			-10...90, analog, programmable		
Compressive strength [bar]	20					
Material	housing: PBT sensor: AISI 316 Ti / FKM					
Protection [EN 60529]	IP 65					
Connection	M12 connector					
Accessories	mounting plate, connecting cable type SLG, SLW (page 1.91), adapter G1/2, adapter G1/4 (page 1.95)					

Vortex-Measuring device • Digital display

Series SDV - Vortex flow measuring device



Flow measuring of water

Deviation 2% of terminal value

Programmable

Analog and PNP output

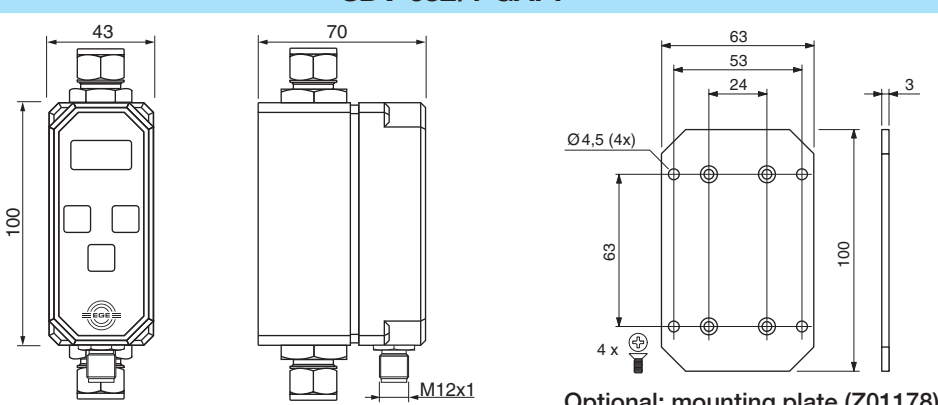

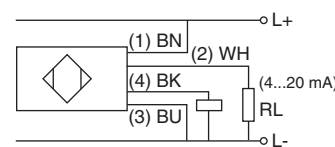
Design	SDV 652/1 GAPP	
Dimensions	 <p style="text-align: right;">Optional: mounting plate (Z01178)</p>	
Working range	[l/min]	2...20
Maximum flow	[l/min]	25
Precision	15...50 °C <2%, 5...60 °C <4%	
Outer diameter pipe	[mm]	10
Pipe connection	tube fittings for steel tubes according to DIN 2391 / ISO 3304	
Output	 PNP NC / NO, programmable 4...20 mA, linear	
ID-No.	P11319	
Type	SDV 652/1 GAPP	
Switching current	[mA]	200
Load R _L	[Ω]	200...500
Supply voltage	[V]	24 DC ±10%
Current consumption	[mA]	<100
Ambient temperature	[°C]	0...+60
Medium temperature	[°C]	5...+60
Start-up time	[s]	4.5...8
Reaction time	[s]	0.5...4
Programmable functions	switching point, hysteresis, switching output, time on/off delay averaging, access code	
Compressive strength	[bar]	10
Material	housing: PBT sensor: PVDF, connection AISI 316 Ti	
Protection	[EN 60529]	IP 65
Connection	M12 connector	
Notice: Process-connection in PTFE available		
Accessories	mounting plate, connecting cable type SLG, SLW (page 1.91), adapter G1/4 (page 1.95)	

Magnetic flowmeter • Digital display



Series SDI - Magnetic flowmeter

Measurement error <2%

Programmable

Analog and PNP output

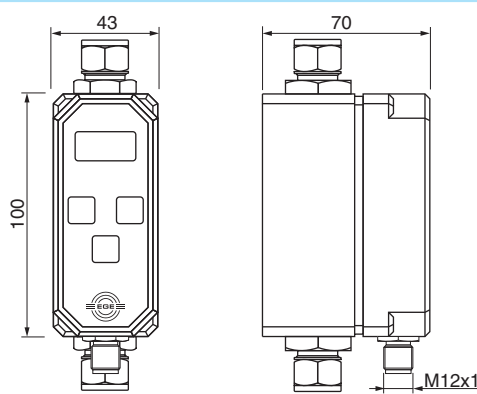
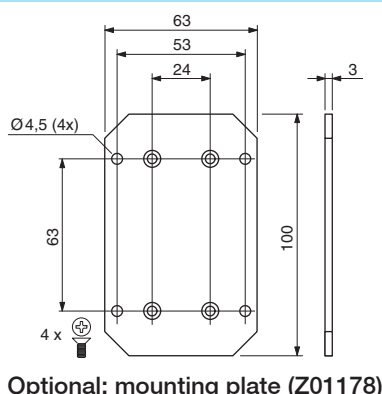

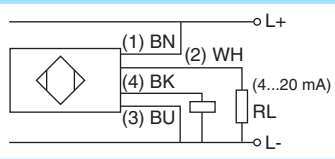
Design	SDI... GAPP	
Dimensions		 <p>Optional: mounting plate (Z01178)</p>
Working range [l/min]	0...40	0.2...80
Measurement error	0...5.0 l/min ≤0.1 l/min 5...40 l/min ≤2% of measurement value*	0...10.0 l/min ≤0.2 l/min 10.1...80 l/min ≤2% of measurement value*
ID-No.	P11320	P11321
Typ	SDI 852/1 GAPP	SDI 852/2 GAPP
Outer diameter pipe [mm]	10	15
Pipe connection	tube fittings for steel tubes according to DIN 2391 / ISO 3304	
Output	 PNP NC / NO, programmable	 4...20 mA, linear
Switching current [mA]	200	
Load RL [Ω]	200...500	
Supply voltage [V]	24 DC ±10%	
Current consumption [mA]	100	
Ambient temperature [°C]	0...+60	
Medium temperature [°C]	5...+60	
Medium conductivity [μS/cm]	≥10 (water: ≥15)	≥20 (water: ≥30)
Reaction time [s]	0.5...8	
Programmable functions	switching point, hysteresis, switching output, time on/off delay analog range, impulse, averaging, access code	
Compressive strength [bar]	10	
Material	housing: PBT sensor: PVDF / AISI 316 Ti	
Protection [EN 60529]	IP 65	
Connection	M12 connector	
*Notice: Reference conditions according to EN 29104		
Accessories	mounting plate, connecting cable type SLG, SLW (page 1.91), adapter G1/4 (page 1.95)	

Magnetic flowmeter • Digital display

Series SDI - Magnetic flowmeter



Measurement error <2%

Programmable

Analog and PNP output

Impulse output

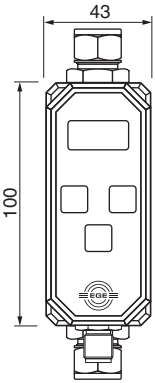
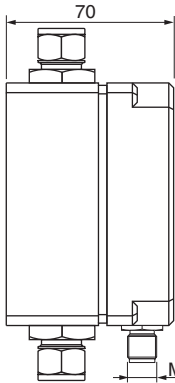
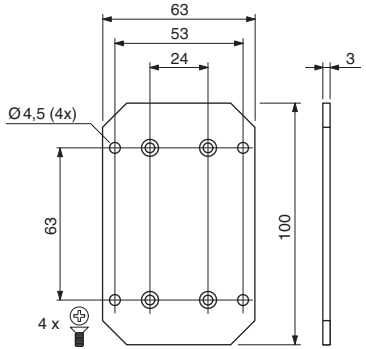

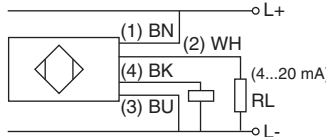
Design	SDI... GAPP	
Dimensions	   <p>Optional: mounting plate (Z01178)</p>	
Working range [l/min]	0...40	0.2...80
Measurement error	0...5.0 l/min ≤0.1 l/min 5...40 l/min ≤2% of measurement value*	0...10.0 l/min ≤0.2 l/min 10.1...80 l/min ≤2% of measurement value*
ID-No.	P11322	P11323
Typ	SDI 853/1 GAPP	SDI 853/2 GAPP
Pulse output ¹	•	•
Outer diameter pipe [mm]	10	15
Pipe connection	tube fittings for steel tubes according to DIN 2391 / ISO 3304	
Output	 PNP NC / NO, programmable	 4...20 mA, linear
Switching current [mA]	200	
Load RL [Ω]	200...500	
Supply voltage [V]	24 DC ±10%	
Current consumption [mA]	100	
Ambient temperature [°C]	0...+60	
Medium temperature [°C]	5...+60	
Medium conductivity [μS/cm]	≥ 10 (water: ≥ 15)	≥ 20 (water: ≥ 30)
Reaction time [s]	0.5...8	
Programmable functions	switching point, hysteresis, switching output, time on/off delay analog range, impulse, averaging, access code	
Compressive strength [bar]	10	
Material	housing: PBT sensor: PVDF / AISI 316 Ti	
Protection [EN 60529]	IP 65	
Connection	M12 connector	
*Notice: Reference conditions according to EN 29104	¹ Impulses can be set to 1, 5, 10 und 50 ml/pulse (SDI 853...GAPP).	
Accessories	mounting plate, connecting cable type SLG, SLW (page 1.91), adapter G1/4 (page 1.95)	

Probe • Stainless steel

Series LTZ

G1/2 thread

Stainless steel

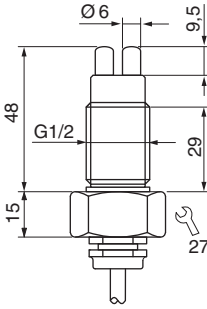
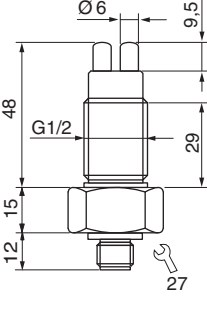

Design	G1/2	G1/2
Dimensions		
Detection range [m/s]	0.5...30	0.5...30
Sensor length [mm]	48	48
ID-No.	P11100	P11101
Type	LTZ 421 K-A2	LTZ 421 S-A2
Medium temperature [°C]	-20...+80	
Temperature gradient [K/min]	20	
Start-up time typ. [s]	10...90	
Reaction time typ. [s]	2...30	
Switching-off time [s]	5...30	
Compressive strength [bar]	30	
Sensor material	AISI 303 • different materials on request	
Protection [EN 60529]	IP 68	IP 67
Connection	2 m PVC-cable 4x0.25 mm ²	M12 connector

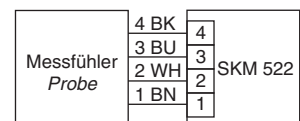
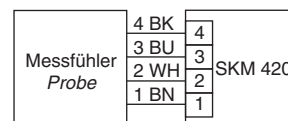
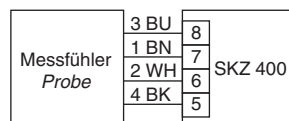
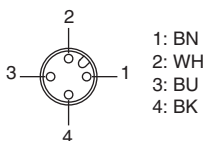

Amplifiers required: SKZ..., SKM..., see page 1.62 - 1.64

Accessories connecting cable type SLG 4-2, SLG 4-5, SLW 4-2, SLW 4-5, see page 1.91

Compact models

Series LN / LG - Air flow controller

DC 24 V
PNP output
Analog output

LED display
Detection range 0.5...15 m/s



Design	Ø20 mm		M18x1		M22x1
Dimensions					
Detection range [m/s]	0.5...15		0.5...15		0.5...15
Output	PNP 4...20 mA		PNP 4...20 mA		PNP
ID-No.	P11096*		P11237*		P11163*
Type	LN 520 GSP		LG 518 GSP		LG 522 GSP
Switching current [mA]	200		200		200
Load RL [Ω]	-		-		-
Supply voltage [V]	24 DC ±20%				
Current consumption [mA]	70				
Ambient temperature [°C]	-20...+70				
Temperature gradient [K/min]	200				
Start-up time [s]	20...40				
Reaction time typ. [s]	2	3	2	3	2
Housing material	PBT		PBT / Br-Ni		PBT / Br-Ni
Display flow	LED				
Protection [EN 60529]	IP 67				
Connection	2 m PVC-cable 3x0.5 mm ²				
* US LISTED					
Accessories	flange Ø20 mm (Z01106), see page 1.94				

Compact models • Hose connection



Series LD 550 - Air flow controller

DC 24 V

PNP output

Fast reaction time

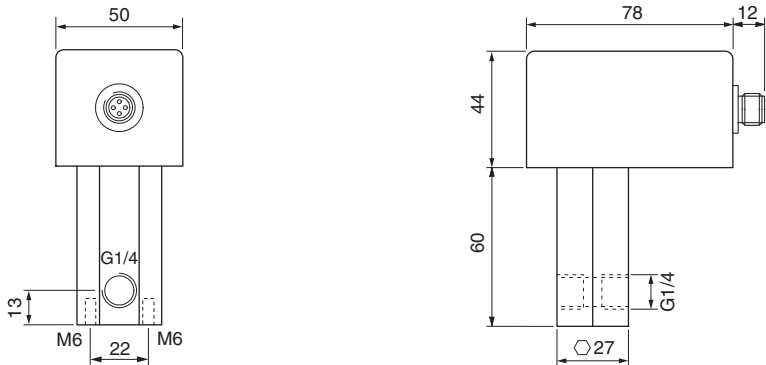

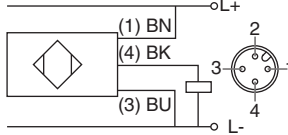
Design	G1/4	
Dimensions		
Detection range	[m/s]	0.3...15
Output		
ID-No.		P11236
Type		LD 550 GSP
Supply voltage	[V]	24 DC ±15%
Current consumption	[mA]	100
Switching current	[mA]	200
Voltage drop	[V]	2
Load R _L	[Ω]	-
Ambient temperature	[°C]	-20...+70
Temperature gradient	[K/min]	400
Start-up time	[s]	15
Reaction time typ.	[s]	0.3
Compressive strength	[bar]	10
Material		AISI 303 / PBT
Protection	[EN 60529]	IP 67
Display flow		LED-array
Connection		M12 connector
Notice:	<p>Only dry and clean air should be used</p>	
		
Accessories	connecting cable type SLG 3-2, SLG 3-5, SLW 3-2, SLW 3-5, see page 1.91	

Compact models

Series LNZ - Air flow controller

DC 24 V

Analog output

G1/2 thread



Design	G1/2	
Dimensions		
Detection range [m/s]	0.5...30	
Output		
ID-No.	P11110*	P11111*
Type	LNZ 450 GA-K	LNZ 450 GA-S
Supply voltage [V]	24 DC ±15 %	
Current consumption [mA]	80	
Current output [mA]	4...20	
Load R _L [Ω]	200...500	
Ambient temperature [°C]	-20...+70	
Medium temperature [°C]	-20...+80	
Temperature gradient [K/min]	20	
Start-up time typ. [s]	20...90	
Reaction time typ. [s]	4...30	
Compressive strength [bar]	30	
Sensor material	AISI 303	
Display flow	LED-array	
Protection [EN 60529]	IP 67	
Connection	2 m PVC-cable 3x0.5 mm ²	M12 connector
*		

Accessories connecting cable type SLG 3-2, SLG 3-5, SLW 3-2, SLW 3-5, see page 1.91

Air Flow Sensors



Compact models

Series LNZ - Air flow controller

AC 230 V • AC 115 V

DC 24 V

Relay output

G1/2 thread



Design	G1/2		G1/2	
Dimensions				
Detection range [m/s]	0.5...30		0.5...30	0.5...30
Output				
ID-No.	P11102		P11103	
Type	LNZ 450 WR1-K		LNZ 450 WR2-K	
Supply voltage [V]	115 AC ±15%		230 AC ±15%	
Current consumption [mA]	60		30	
Switching voltage [V]	250 AC / 60 DC		250 AC / 60 DC	
Switching current [A]	4 AC / 4 DC		4 AC / 4 DC	
Switching power max.	1000 VA / 60 W		1000 VA / 60 W	
Ambient temperature [°C]	-20...+70		-20...+70	
Medium temperature [°C]	-20...+80		-20...+80	
Temperature gradient [K/min]	20		20	
Start-up time typ. [s]	10...90		10...90	
Reaction time typ. [s]	2...30		2...30	
Compressive strength [bar]	30		30	
Sensor material	AISI 303		AISI 303	
Housing material	PBT		PBT	
Display flow	LED-array		LED-array	
Protection [EN 60529]	IP 67		IP 67	
Connection	2 m PVC-cable 5x0.5 mm ²		2 m PVC-cable 5x0.5 mm ²	M12 connector

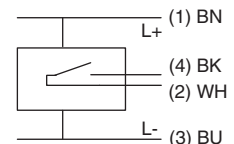
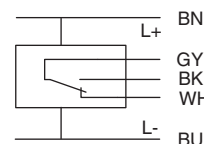
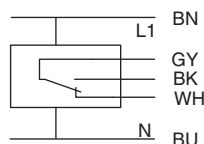
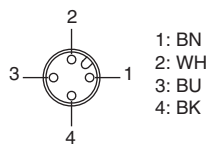

Accessories connecting cable type SLG 4-2, SLG 4-5, SLW 4-2, SLW 4-5, see page 1.91

Compact models • Sleeve mounting

Series LN - Air flow controller

AC 230 V • AC 115 V

DC 24 V

Relay output

Suitable for assembly
thread pieces



Design	G1		G1	
Dimensions				
Detection range [m/s]	0.5...30		0.5...30	0.5...30
Output				
ID-No.	P11106	P11107	P11108	P11109
Type	LN 450 WR1-K	LN 450 WR2-K	LN 450 GR-K	LN 450 GR-S
Supply voltage [V]	115 AC ±15%		24 DC ±20%	
Current consumption [mA]	60		80	
Switching voltage [V]	250 AC / 60 DC		250 AC / 60 DC	
Switching current [A]	4 AC / 4 DC		4 AC / 4 DC	2 AC / 2 DC
Switching power max.	1000 VA / 60 W		1000 VA / 60 W	500 VA / 60 W
Ambient temperature [°C]	-20...+70		-20...+70	
Medium temperature [°C]	-20...+80		-20...+80	
Temperature gradient [K/min]	20		20	
Start-up time typ. [s]	10...90		10...90	
Reaction time typ. [s]	2...30		2...30	
Compressive strength [bar]	3		3	
Sensor material	AISI 303 / Delrin		AISI 303 / Delrin	
Housing material	PBT		PBT	
Display flow	LED-array		LED-array	
Protection [EN 60529]	IP 67		IP 67	
Connection	2 m PVC-cable 5x0.5 mm ²		2 m PVC-cable 5x0.5 mm ²	M12 connector
Accessories	thread sleeve A 50..., see page 1.94			

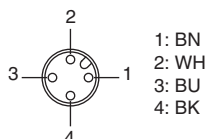

Compact models • Sleeve mounting



Series LN - Air flow controller

DC 24 V

Analog output

Suitable for assembly
thread pieces

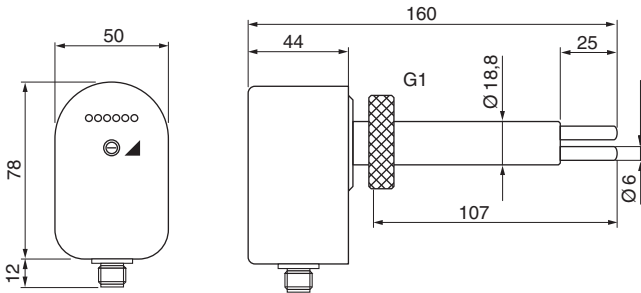

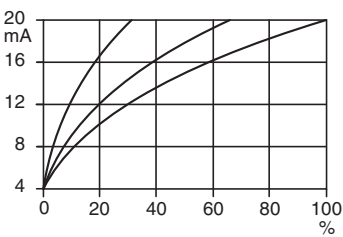
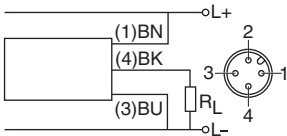
Design	G1	
Dimensions		
Detection range	[m/s]	0.5...30
Output		
ID-No.	P11098*	P11099*
Type	LN 450 GA-K	LN 450 GA-S
Supply voltage	[V]	24 DC ±15%
Current consumption	[mA]	80
Current output	[mA]	4...20
Load RL	[Ω]	200...500
Ambient temperature	[°C]	-20...+70
Medium temperature	[°C]	-20...+80
Temperature gradient	[K/min]	20
Start-up time typ.	[s]	20...90
Reaction time typ.	[s]	4...30
Compressive strength	[bar]	3
Sensor material	AISI 303 / Delrin	
Display flow	LED-array	
Protection	[EN 60529]	IP 67
Connection	2 m PVC-cable, 3x0.5 mm ²	M12 connector
<div style="display: flex; align-items: center;"> <div style="margin-right: 10px;">*  US LISTED</div> <div style="flex-grow: 1;">  </div> <div style="margin-left: 20px;">  </div> </div>		
Accessories	thread sleeve A 50..., see page 1.94	

Inline-Compact • Air flow





Series LDN - Air flow controller

PNP output
Relay output
Analog output

G1/4 thread • Ø9 mm

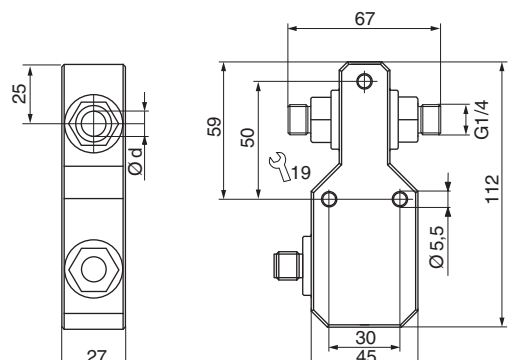
Compressed-air monitoring

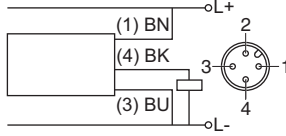
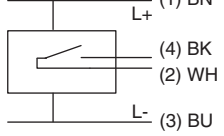
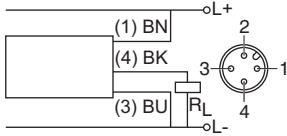

Design	G1/4 • Ø9 mm		
Dimensions			
Detection range [m/s]	0.2...60		
Working range [m/s]	0.5...40		
Inner diameter d [mm]	9		
Output	 PNP	 Relay	 4...20 mA, non linear
ID-No.	P11299 *	P11300	P11301 *
Type	LDN 510 GSP	LDN 510 GR	LDN 510 GA
Switching current [mA]	200	1000	-
Switching voltage [V]	-	30 AC / 36 DC	-
Load RL [Ω]	-	-	200...500
Supply voltage [V]	24 DC ±10%		
Current consumption [mA]	<50		
Ambient temperature [°C]	0...+60		
Medium temperature [°C]	-20...+80		
Temperature gradient [K/min]	20		
Start-up time typ. [s]	10...30		
Reaction time typ. [s]	1...20		
Compressive strength [bar]	20		
Display flow	LED-array		
Material	housing: PBT sensor: AISI 316 Ti (A4)		
Protection [EN 60529]	IP 67		
Connection	M12 connector		
*  US LISTED			
Accessories	connecting cable type SLG, SLW, SBG, SBW, see page 1.91		

Amplifiers

Series SKM

DC 24 V

Analog output

Relay output

LED display



Design	SKM 420 GR	SKM 421 GR	SKM 420 GA
Dimensions			
ID-No.	P10530	P11067	P10820
Type	SKM 420 GR	SKM 421 GR (air flow)	SKM 420 GA
Output	Relay	Relay	4...20 mA
Supply voltage [V]	24 DC ±20%		24 DC ±10%
Output	relay / NO		analog 4...20 mA
Switching voltage [V]	230 AC / 250 DC		-
Switching current [A]	1 AC / 1 DC		-
Switching power max.	125 VA / 60 W		-
Load R _L [Ω]	-		50...500
Ambient temperature [°C]	-20...+60		-20...+60
Protection [EN 60529]	IP 20		IP 20
Terminal housing	IP 40		IP 40

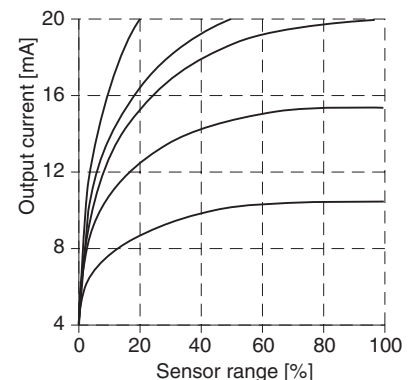
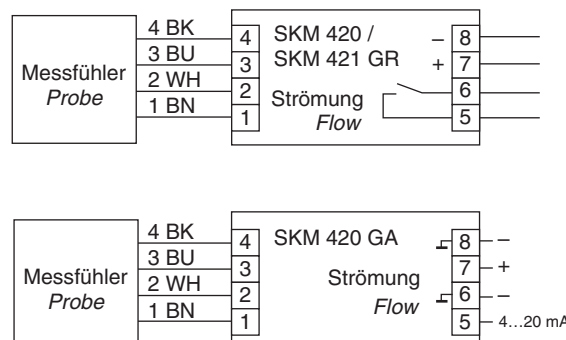
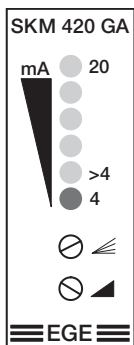

Amplifiers

Series SKM

AC 85 V...AC 260 V
DC 24 V

Relay output

Programming with push-buttons
Automatic adjustment



Design	SKM 522 WR	SKM 522 GR
Dimensions		
ID-No.	P11336	P11337
Type	SKM 522 WR	SKM 522 GR
Output	Relay	Relay
Supply voltage [V]	85 AC...260 AC	24 DC ±20%
Turn off delay [s]	0...20 programmable	
Output	2x relay / change-over	
Switching voltage [V]	250 AC / 60 DC	
Switching current [A]	4 AC / 4 DC	
Switching power max.	1000 VA / 60 W	
Ambient temperature	-20...+60	
Additional functions	cable break monitoring, turn off delay, supply voltage monitoring	
Protection [EN 60529]	terminal: IP 20 / housing: IP 40	
Connection	terminal screws	

Amplifiers

Series SKZ

AC 230 V • AC 115 V

DC 24 V





Relay output

LED display

Temperature control

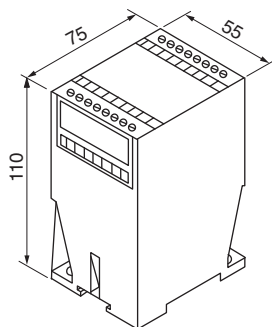
Turn off delay



Design	SKZ 400 WR	SKZ 400 WR-115	SKZ 400 GR
Dimensions			
ID-No.	P10501	P10502	P10503
Type	SKZ 400 WR	SKZ 400 WR -115	SKZ 400 GR
Output	 Relay	 Relay	 Relay
Supply voltage [V]	230 AC +10/-20%	115 AC +10/-15%	24 DC ±20%
Temperature [°C]		-20...+100 adjustable	
Turn off delay [s]		0...25 adjustable	
Output		2x relay / change-over	
Switching voltage [V]		250 AC / 60 DC	
Switching current [A]		4 AC / 4 DC	
Switching power max.		1000 VA / 60 W	
Ambient temperature [°C]		-20...+60	
Protection [EN 60529]		terminal: IP 20 / housing: IP 40	
Connection		terminal screws	

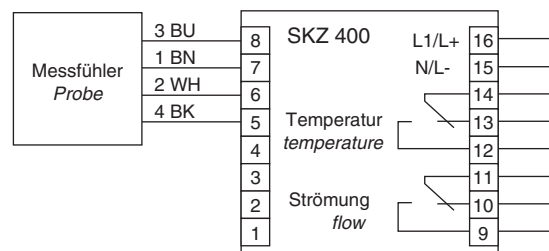

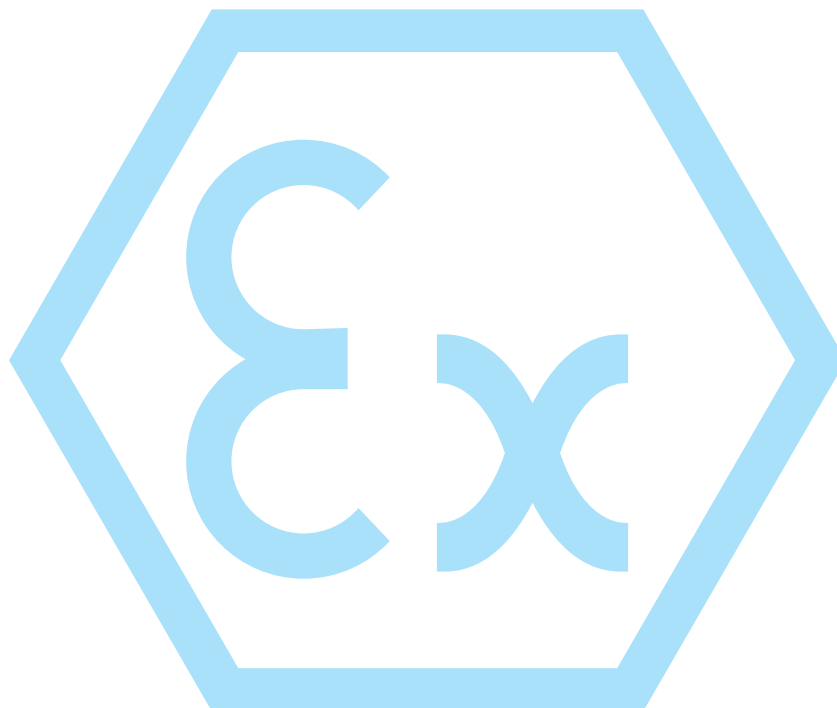

Probes
Compact models
Amplifiers

Ex - Probe • Category 1/2 - 1 • Zone 0/1 - 20

Series STS

Gas-Ex Category 1/2

Ex II 1/2 G Ex ia IIC T6 Ga/Gb

Dust-Ex Category 1

Ex II 1 D Ex ia IIIC T100 °C Da



Design	G1/4	G1/2	G1/2	NPT1/2	G3/4
Dimensions					
Detection range [cm/s]	water 1...100 / oil 3...200				
Sensor length [mm]	25	31	48	40	48
Connection	plug	plug	plug	plug	plug
ID-No.	P11164	P11165	P11166	P11167	P11169
Type	STS 101 S	STS 102 S	STS 103 S	STS 104 S	STS 106 S
Ex area of use	Gas: Zone 0/1 / Dust: Zone 20				
Certificate No.	TÜV 98 ATEX 1298 X				
Ex marking	Gas:	Ex II 1/2 G Ex ia IIC T6 Ga/Gb			
	Dust:	Ex II 1 D Ex ia IIIC T100 °C Da			
Ambient temperature and medium temperature [°C]	Gas:	T6: -20 ≤ Ta ≤ +40 T5: -20 ≤ Ta ≤ +55 T4: -20 ≤ Ta ≤ +60 T3: -20 ≤ Ta ≤ +60			
	Dust:	-20 ≤ Ta ≤ +60			
Maximum values	Ui = 13.65 V / li = 200 mA / Pi = 0.69 W / Ci = 0.27 nF / Li = 1.30 µH				
Start-up time typ. [s]	8 (2...18)				
Reaction time typ. [s]	2 (1...13)				
Compressive strength [bar]	60				
Housing material	AISI 316 Ti • different materials on request				
Protection [EN 60529]	IP 67				
Connection	M12 connector				
	(probes with cable length > 2 m are available on request)				
Notice	for the connection to amplifiers SZA..., SEA..., SS 400, see page 1.85 - 1.88				

Ex - Probe • Category 1/2 - 1 • Zone 0/1 - 20

Series STS

Gas-Ex Category 1/2

Ex II 1/2 G Ex ia IIC T6 Ga/Gb

Dust-Ex Category 1

Ex II 1 D Ex ia IIIC T100 °C Da



Design	G1/4	G1/2	G1/2	NPT1/2	G3/4
Dimensions					
Detection range [cm/s]	water 1...100 / oil 3...200				
Sensor length [mm]	25	31	48	40	48
Connection	fixed cable	fixed cable	fixed cable	fixed cable	fixed cable
ID-No.	P11140	P11141	P11142	P11143	P11168
Type	STS 101 K	STS 102 K	STS 103 K	STS 104 K	STS 106 K
Ex area of use	Gas: Zone 0/1 / Dust: Zone 20				
Certificate No.	TÜV 98 ATEX 1298 X				
Ex marking	Gas:	Ex II 1/2 G Ex ia IIC T6 Ga/Gb			
	Dust:	Ex II 1 D Ex ia IIIC T100 °C Da			
Ambient temperature [°C] and medium temperature	Gas:	T6: -20 ≤ Ta ≤ +40 T5: -20 ≤ Ta ≤ +55 T4: -20 ≤ Ta ≤ +60 T3: -20 ≤ Ta ≤ +60			
	Dust:	-20 ≤ Ta ≤ +60			
Maximum values	Ui = 13.65 V / li = 200 mA / Pi = 0.69 W / Ci = 0.27 nF / Li = 1.30 µH				
Start-up time typ. [s]	8 (2...18)				
Reaction time typ. [s]	2 (1...13)				
Compressive strength [bar]	60				
Housing material	AISI 316 Ti • different materials on request				
Protection [EN 60529]	IP 68				
Connection	2 m PUR-cable 4x0.25 mm ²				
	(probes with cable length > 2 m are available on request)				
Notice	for the connection to amplifiers SZA..., SEA..., SS 400, see page 1.85 - 1.88				

Ex - Probe • Category 2 • Zone 1 - 21

Series ST

Gas-Ex Category 2

Ex II 2 G Ex ib IIC T6 Gb

Dust-Ex Category 2

Ex II 2 D Ex ib IIIC T125 °C Db



Design	G1/4	G1/2	G1/2	NPT1/2	G3/4																								
Dimensions																													
Detection range [cm/s]	water 1...100 / oil 3...200																												
Sensor length [mm]	25	31	48	40	48																								
Connection	plug	plug	plug	plug	plug																								
ID-No.	P11170	P11171	P11172	P11173	P11175																								
Type	ST 101 S	ST 102 S	ST 103 S	ST 104 S	ST 106 S																								
Ex area of use	Gas: Zone 1 / Dust: Zone 21																												
Certificate No.	TÜV 97 ATEX 1218																												
Ex marking	Gas: Ex II 2 G Ex ib IIC T6 Gb Dust: Ex II 2 D Ex ib IIIC T125 °C Db																												
Ambient temperature and medium temperature [°C]	Gas: T6: -20 ≤ Ta ≤ +40 T5: -20 ≤ Ta ≤ +55 T4: -20 ≤ Ta ≤ +85 T3: -20 ≤ Ta ≤ +85 Dust: -20 ≤ Ta ≤ +85																												
Maximum values	Ui = 13.65 V / li = 200 mA / Pi = 0.69 W / Ci = 0.27 nF / Li = 1.30 µH																												
Start-up time typ. [s]	8 (2...18)																												
Reaction time typ. [s]	2 (1...13)																												
Compressive strength [bar]	60																												
Housing material	AISI 316 Ti • different materials on request																												
Protection [EN 60529]	IP 67																												
Connection	M12 connector																												
	<div style="display: flex; justify-content: space-around;"> <div style="border: 1px solid black; padding: 5px;"> <table border="1"> <tr><td>Messfühler</td><td>1 BN</td><td>d26</td></tr> <tr><td>Probe</td><td>2 WH</td><td>d28</td></tr> <tr><td></td><td>3 BU</td><td>d30</td></tr> <tr><td></td><td>4 BK</td><td>d32</td></tr> </table> <p>SEA</p> </div> <div style="border: 1px solid black; padding: 5px;"> <table border="1"> <tr><td>Messfühler</td><td>3 BU</td><td>8</td></tr> <tr><td>Probe</td><td>1 BN</td><td>7</td></tr> <tr><td></td><td>2 WH</td><td>6</td></tr> <tr><td></td><td>4 BK</td><td>5</td></tr> </table> <p>SZA</p> </div> </div> <p>(probes with cable length > 2 m are available on request)</p>					Messfühler	1 BN	d26	Probe	2 WH	d28		3 BU	d30		4 BK	d32	Messfühler	3 BU	8	Probe	1 BN	7		2 WH	6		4 BK	5
Messfühler	1 BN	d26																											
Probe	2 WH	d28																											
	3 BU	d30																											
	4 BK	d32																											
Messfühler	3 BU	8																											
Probe	1 BN	7																											
	2 WH	6																											
	4 BK	5																											
Notice	for the connection to amplifiers SZA..., SEA..., SS 400, see page 1.85 - 1.88																												

Ex - Probe • Category 2 • Zone 1 - 21

Series ST



Gas-Ex Category 2

Ex II 2 G Ex ib IIC T6 Gb

Dust-Ex Category 2

Ex II 2 D Ex ib IIIC T125 °C Db

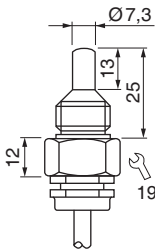
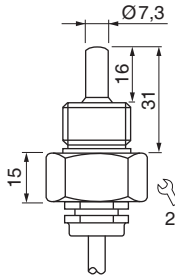
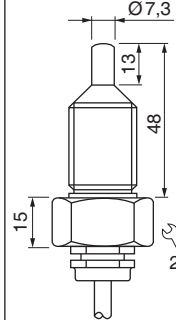
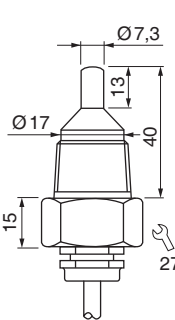
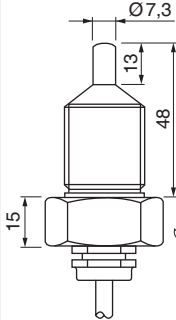

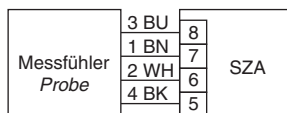
Design	G1/4	G1/2	G1/2	NPT1/2	G3/4
Dimensions					
Detection range [cm/s]	Wasser 1...100 / Öl 3...200				
Sensor length [mm]	25	31	48	40	48
Connection	fixed cable	fixed cable	fixed cable	fixed cable	fixed cable
ID-No.	P11144	P11145	P11146	P11147	P11174
Type	ST 101 K	ST 102 K	ST 103 K	ST 104 K	ST 106 K
Ex area of use	Gas: Zone 1 / Dust: Zone 21				
Certificate No.	TÜV 97 ATEX 1218				
Ex marking	Gas: Ex II 2 G Ex ib IIC T6 Gb Dust: Ex II 2 D Ex ib IIIC T125 °C Db				
Ambient temperature [°C] and medium temperature	Gas: T6: -20 ≤ Ta ≤ +40 T5: -20 ≤ Ta ≤ +55 T4: -20 ≤ Ta ≤ +85 T3: -20 ≤ Ta ≤ +85 Dust: -20 ≤ Ta ≤ +85				
Maximum values	Ui = 13.65 V / li = 200 mA / Pi = 0.69 W / Ci = 0.27 nF / Li = 1.30 µH				
Start-up time typ. [s]	8 (2...18)				
Reaction time typ. [s]	2 (1...13)				
Compressive strength [bar]	60				
Housing material	AISI 316 Ti • different materials on request				
Protection [EN 60529]	IP 68				
Connection	2 m PUR-cable 4x0.25 mm ²				
					
	(probes with cable length > 2 m are available on request)				
Notice	for the connection to amplifiers SZA..., SEA..., SS 400, see page 1.85 - 1.88				

Ex - Probe • Category 2 • Zone 1 - 21

Series ST

Gas-Ex Category 2



Ex II 2 G Ex ib IIC T6 Gb

Dust-Ex Category 2

Ex II 2 D Ex ib IIIC T125 °C Db

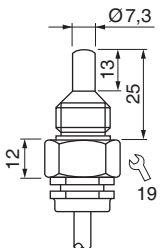
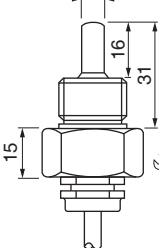
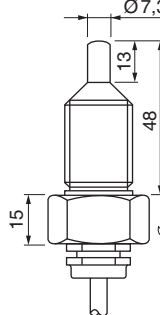
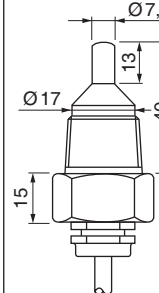
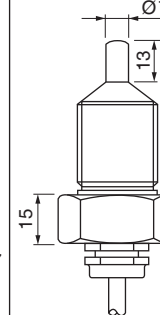
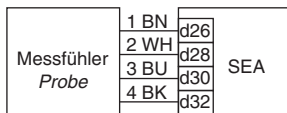

Extended temperature range

Design	G1/4	G1/2	G1/2	NPT1/2	G3/4
Dimensions					
Detection range [cm/s]	water 1...100 / oil 3...200				
Sensor length [mm]	25	31	48	40	48
Connection	fixed cable	fixed cable	fixed cable	fixed cable	fixed cable
ID-No.	P11176	P11178	P11180	P11182	P11184
Type	ST 101 KH	ST 102 KH	ST 103 KH	ST 104 KH	ST 106 KH
Ex area of use	Gas: Zone 1 / Dust: Zone 21				
Certificate No.	TÜV 97 ATEX 1218				
Ex marking	Gas: Ex II 2 G Ex ib IIC T6 Gb Dust: Ex II 2 D Ex ib IIIC T125 °C Db				
Ambient temperature and medium temperature [°C]	Gas: T6: +10 ≤ Ta ≤ +40 T5: +10 ≤ Ta ≤ +55 T4: +10 ≤ Ta ≤ +90 T3: +10 ≤ Ta ≤ +120 Dust: -20 ≤ Ta ≤ +85				
Maximum values	Ui = 13.65 V / li = 200 mA / Pi = 0.69 W / Ci = 0.27 nF / Li = 1.30 μH				
Start-up time typ. [s]	8 (2...18)				
Reaction time typ. [s]	2 (1...13)				
Compressive strength [bar]	60				
Housing material	AISI 316 Ti • different materials on request				
Protection [EN 60529]	IP 68				
Connection	2 m FEP-cable 4x0.25 mm ²				
					
	(probes with cable length > 2 m are available on request)				
Notice	for the connection to amplifiers SZA..., SEA..., SS 400, see page 1.85 - 1.88				

Ex - Probe • Category 1/2 - 1 • Zone 0/1 - 20

Series STS

Gas-Ex Category 1/2

Ex II 1/2 G Ex ia IIC T6 Ga/Gb

Dust-Ex Category 1

Ex II 1 D Ex ia IIIC T100 °C Da



Design	G1/2				
Dimensions					
Detection range [cm/s]	water 1...100 / oil 3...200				
Sensor length L [mm]	48	48	80	110	140
Connection	fixed cable	plug	fixed cable	fixed cable	fixed cable
ID-No.	P11186	P11187	P11188	P11189	P11190
Type	STS 110 K	STS 110 S	STS 110 K-L80	STS 110 K-L110	STS 110 K-L140
Ex area of use	Gas: Zone 0/1 / Dust: Zone 20				
Certificate No.	TÜV 98 ATEX 1298 X				
Ex marking	Gas: Ex II 1/2 G Ex ia IIC T6 Ga/Gb Dust: Ex II 1 D Ex ia IIIC T100 °C Da				
Ambient temperature and medium temperature [°C]	Gas: T6: $-20 \leq T_a \leq +40$ T5: $-20 \leq T_a \leq +55$ T4: $-20 \leq T_a \leq +60$ T3: $-20 \leq T_a \leq +60$ Dust: $-20 \leq T_a \leq +60$				
Maximum values	$U_i = 13.65 \text{ V}$ / $I_i = 200 \text{ mA}$ / $P_i = 0.69 \text{ W}$ / $C_i = 0.27 \text{ nF}$ / $L_i = 1.30 \mu\text{H}$				
Start-up time typ. [s]	8 (2...18)				
Reaction time typ. [s]	2 (1...13)				
Compressive strength [bar]	60				
Housing material	AISI 316 Ti • different materials on request				
Protection [EN 60529]	cable ...K: IP 68 / plug...S: IP 67				
Connection	...K: 2 m PUR-cable 4x0.25 mm ² ...S: M12 connector				
	(probes with cable length > 2 m are available on request)				
Notice	for the connection to amplifiers SZA..., SEA..., SS 400, see page 1.85 - 1.88				

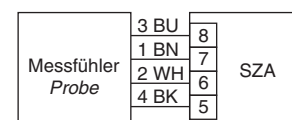
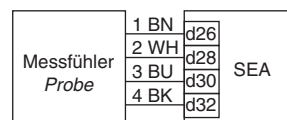
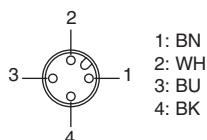

Ex - Probe • Category 2 • Zone 1 - 21

Series ST

Gas-Ex Category 2

Ex II 2 G Ex ib IIC T6 Gb

Dust-Ex Category 2

Ex II 2 D Ex ib IIIC T125 °C Db



Design	G1/2				
Dimensions					
Detection range [cm/s]	water 1...100 / oil 3...200				
Sensor length L [mm]	48	48	80	110	140
Connection	fixed cable	plug	fixed cable	fixed cable	fixed cable
ID-No.	P11192	P11193	P11194	P11195	P11196
Type	ST 110 K	ST 110 S	ST 110 K-L80	ST 110 K-L110	ST 110 K-L140
Ex area of use	Gas: Zone 1 / Dust: Zone 21				
Certificate No.	TÜV 97 ATEX 1218				
Ex marking	Gas: Ex II 2 G Ex ib IIC T6 Gb Dust: Ex II 2 D Ex ib IIIC T125 °C Db				
Ambient temperature and medium temperature [°C]	Gas: T6: -20 ≤ Ta ≤ +40 T5: -20 ≤ Ta ≤ +55 T4: -20 ≤ Ta ≤ +85 T3: -20 ≤ Ta ≤ +85 Dust: -20 ≤ Ta ≤ +85				
Maximum values	Ui = 13.65 V / li = 200 mA / Pi = 0.69 W / Ci = 0.27 nF / Li = 1.30 µH				
Start-up time typ. [s]	8 (2...18)				
Reaction time typ. [s]	2 (1...13)				
Compressive strength [bar]	60				
Housing material	AISI 316 Ti • different materials on request				
Protection [EN 60529]	cable ...K: IP 68 / plug ...S: IP 67				
Connection	...K: 2 m PUR-cable 4x0.25 mm² / ...S: M12 connector				
	(probes with cable length > 2 m are available on request)				
Notice	for the connection to amplifiers SZA..., SEA..., SS 400, see page 1.85 - 1.88				

- Probe • Category 2 • Zone 1 - 21

Series ST

Gas-Ex Category 2

II 2 G Ex ib IIC T6 Gb

Dust-Ex Category 2

II 2 D Ex ib IIIC T125 °C Db

Extended temperature range



Design	G1/2			
Dimensions				
Detection range [cm/s]	water 1...100 / oil 3...200			
Sensor length L [mm]	48	80	110	140
Connection	fixed cable	fixed cable	fixed cable	fixed cable
ID-No.	P11198	P11200	P11201	P11202
Type	ST 110 KH	ST 110 KH-L80	ST 110 KH-L110	ST 110 KH-L140
Ex area of use	Gas: Zone 1 / Dust: Zone 21			
Certificate No.	TÜV 97 ATEX 1218			
Ex marking	Gas:	II 2 G Ex ib IIC T6 Gb		
	Dust:	II 2 D Ex ib IIIC T125 °C Db		
Ambient temperature and medium temperature [°C]	Gas:	T6: +10 ≤ Ta ≤ +40 T5: +10 ≤ Ta ≤ +55 T4: +10 ≤ Ta ≤ +90 T3: +10 ≤ Ta ≤ +120		
	Dust:	-20 ≤ Ta ≤ +85		
Maximum values	Ui = 13.65 V / li = 200 mA / Pi = 0.69 W / Ci = 0.27 nF / Li = 1.30 μH			
Start-up time typ. [s]	8 (2...18)			
Reaction time typ. [s]	2 (1...13)			
Compressive strength [bar]	60			
Housing material	AISI 316 Ti • different materials on request			
Protection [EN 60529]	IP 68			
Connection	2 m FEP-cable 4x0.25 mm ²			
	(probes with cable length > 2 m are available on request)			
Notice	for the connection to amplifiers SZA..., SEA..., SS 400, see page 1.85 - 1.88			

Ex - Probe • Category 1/2 - 1 • Zone 0/1 - 20

Series STS

Gas-Ex Category 1/2

Ex II 1/2 G Ex ia IIC T6 Ga/Gb

Dust-Ex Category 1

Ex II 1 D Ex ia IIIC T100 °C Da

With welded standard flange



Design	DN25 / PN40 (EN 1092-1/05 A)		
Dimensions			
Detection range [cm/s]	water 1...100 / oil 3...200		
Sensor length L [mm]	80	110	140
Connection	fixed cable	fixed cable	fixed cable
ID-No.	P11191	P11148	P11149
Type	STS 111 K-L80	STS 111 K-L110	STS 111 K-L140
Ex area of use	Gas: Zone 0/1 / Dust: Zone 20		
Certificate No.	TÜV 98 ATEX 1298 X		
Ex marking	Gas:	Ex II 1/2 G Ex ia IIC T6 Ga/Gb	
	Dust:	Ex II 1 D Ex ia IIIC T100 °C Da	
Ambient temperature and Medium temperature [°C]	Gas:	T6: $-20 \leq T_a \leq +40$ T5: $-20 \leq T_a \leq +55$ T4: $-20 \leq T_a \leq +60$ T3: $-20 \leq T_a \leq +60$	
	Dust:	$-20 \leq T_a \leq +60$	
Maximum values	$U_i = 13.65 \text{ V} / I_i = 200 \text{ mA} / P_i = 0.69 \text{ W} / C_i = 0.27 \text{ nF} / L_i = 1.30 \text{ }\mu\text{H}$		
Start-up time typ. [s]	8 (2...18)		
Reaction time typ. [s]	2 (1...13)		
Compressive strength [bar]	60		
Housing material	AISI 316 Ti • different materials on request		
Protection [EN 60529]	IP 68		
Connection	2 m PUR-cable 4x0.25 mm ²		

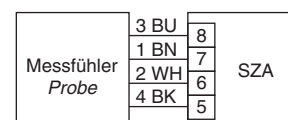
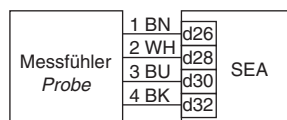

(probes with cable length > 2 m and different flanges are available on request)

Notice for the connection to amplifiers SZA..., SEA..., SS 400, see page 1.85 - 1.88

Ex - Probe • Category 2 • Zone 1 - 21

Series ST

Gas-Ex Category 2

Ex II 2 G Ex ib IIC T6 Gb

Dust-Ex Category 2

Ex II 2 D Ex ib IIIC T125 °C Db

With welded standard flange



Design	DN25 / PN40 (EN 1092-1/05 A)		
Dimensions			
Detection range [cm/s]	water 1...100 / oil 3...200		
Sensor length L [mm]	80	110	140
Connection	fixed cable	fixed cable	fixed cable
ID-No.	P11197	P11150	P11151
Type	ST 111 K-L80	ST 111 K-L110	ST 111 K-L140
Ex area of use	Gas: Zone 1 / Dust: Zone 21		
Certificate No.	TÜV 97 ATEX 1218		
Ex marking	Gas:	Ex II 2 G Ex ib IIC T6 Gb	
	Dust:	Ex II 2 D Ex ib IIIC T125 °C Db	
Ambient temperature and medium temperature [°C]	Gas:	T6: -20 ≤ Ta ≤ +40 T5: -20 ≤ Ta ≤ +55 T4: -20 ≤ Ta ≤ +85 T3: -20 ≤ Ta ≤ +85	
	Dust:	-20 ≤ Ta ≤ +85	
Maximum values	Ui = 13.65 V / li = 200 mA / Pi = 0.69 W / Ci = 0.27 nF / Li = 1.30 µH		
Start-up time typ. [s]	8 (2...18)		
Reaction time typ. [s]	2 (1...13)		
Compressive strength [bar]	60		
Housing material	AISI 316 Ti • different materials on request		
Protection [EN 60529]	IP 68		
Connection	2 m PUR-cable 4x0.25 mm ²		
	(probes with cable length > 2 m and different flanges are available on request)		
Notice	for the connection to amplifiers SZA..., SEA..., SS 400, see page 1.85 - 1.88		

Ex - Probe • Category 2 • Zone 1 - 21

Series ST

Gas-Ex Category 2

Ex II 2 G Ex ib IIC T6 Gb



Dust-Ex Category 2

Ex II 2 D Ex ib IIIC T125 °C Db

With welded standard flange

Extended temperature range

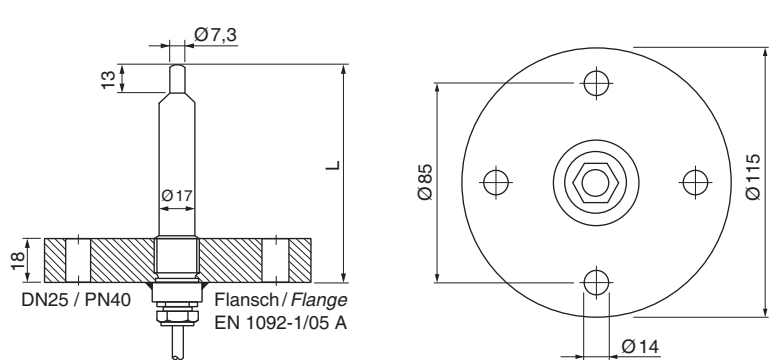
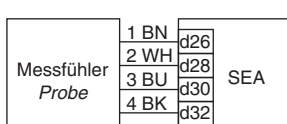

Design	DN25 / PN40 (EN 1092-1/05 A)		
Dimensions			
Detection range [cm/s]	water 1...100 / oil 3...200		
Sensor length L [mm]	80	110	140
Connection	fixed cable	fixed cable	fixed cable
ID-No.	P11203	P11204	P11205
Type	ST 111 KH-L80	ST 111 KH-L110	ST 111 KH-L140
Ex area of use	Gas: Zone 1 / Dust: Zone 21		
Certificate No.	TÜV 97 ATEX 1218		
Ex marking	Gas:	Ex II 2 G Ex ib IIC T6 Gb	
	Dust:	Ex II 2 D Ex ib IIIC T125 °C Db	
Ambient temperature and medium temperature [°C]	Gas:	T6: +10 ≤ Ta ≤ +40 T5: +10 ≤ Ta ≤ +55 T4: +10 ≤ Ta ≤ +90 T3: +10 ≤ Ta ≤ +120	
	Dust:	-20 ≤ Ta ≤ +85	
Maximum values	Ui = 13.65 V / li = 200 mA / Pi = 0.69 W / Ci = 0.27 nF / Li = 1.30 µH		
Start-up time typ. [s]	8 (2...18)		
Reaction time typ. [s]	2 (1...13)		
Compressive strength [bar]	60		
Housing material	AISI 316 ti • different materials on request		
Protection [EN 60529]	IP 68		
Connection	2 m FEP-cable 4x0,25 mm²		
			
	(probes with cable length > 2 m and different flanges are available on request)		
Notice	for the connection to amplifiers SZA..., SEA..., SS 400, see page 1.85 - 1.88		

Ex - Probe • Category 1/2 - 1 • Zone 0/1 - 20

Series STSEX

Gas-Ex Category 1/2

Ex II 1/2 G Ex ia IIC T6 Ga/Gb

Dust-Ex Category 1

Ex II 1 D Ex ia IIIC T100 °C Da

Terminal clamps



Design	G3/4	NPT3/4
Dimensions		
Detection range [cm/s]	water 1...100 / oil 3...200	water 1...100 / oil 3...200
Sensor length [mm]	68	68
ID-No.	P11268	P11269
Type	STSEX 01	STSEX 02
Ex area of use	Gas: Zone 0/1 / Dust: Zone 20	
Certificate No.	TÜV 98 ATEX 1298 X	
Ex marking	Gas: Ex II 1/2 G Ex ia IIC T6 Ga/Gb Dust: Ex II 1 D Ex ia IIIC T100 °C Da	
Ambient temperature and medium temperature [°C]	Gas: T6: $-20 \leq T_a \leq +40$ T5: $-20 \leq T_a \leq +55$ T4: $-20 \leq T_a \leq +60$ T3: $-20 \leq T_a \leq +60$ Dust: $-20 \leq T_a \leq +60$	
Maximum values	U _i = 13.65 V / I _i = 200 mA / P _i = 0.69 W / C _i = 0.27 nF / L _i = 1.30 µH	
Start-up time typ. [s]	8 (2...18)	
Reaction time typ. [s]	2 (1...13)	
Terminal clamps [mm]	cable diameter 5.5...8.5	
Housing material	AISI 316 Ti • different materials on request	
Protection [EN 60529]	IP 67	
Connection cable	2 m PVC 4x0.75 mm ² (number 1-4)	

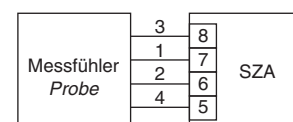
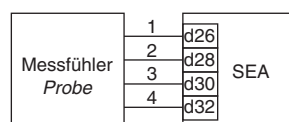
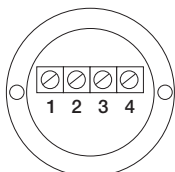

Notice for the connection to amplifiers SZA..., SEA..., SS 400, see page 1.85 - 1.88

Ex - Inline-Sensor • Category 2 • Zone 1

Series SD 4 Ex / SD 9 Ex

Gas-Ex Category 2

Ex II 2G Ex ib IIC T6...T4

G1/4 thread

M12 thread

M16 thread

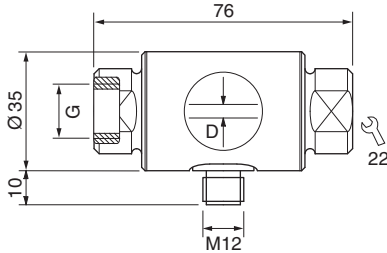

Design	SD			
Dimensions				
Detection range [ml/min]		water 10...150 oil 25...300		water 50...900 oil 150...1800
Thread G	M12	M16	G1/4	M16
Inner diameter D	3.5	3.5	3.5	9.3
ID-No.	P11091	P11092	P11117	P11093
Type	SD 4 Ex M12	SD 4 Ex M16	SD 4 Ex G1/4	SD 9 Ex M16
Ex area of use	Gas: Zone 1			
Certificate No.	TÜV 96 ATEX 1094			
Ex marking	Gas: Ex II 2G Ex ib IIC T6...T4			
Ambient temperature [°C]	T6: -20 ≤ Ta ≤ +50 T5: -20 ≤ Ta ≤ +65 T4: -20 ≤ Ta ≤ +70			
Medium temperature [°C]	-20 ≤ Ta ≤ +70			
Maximum values	Ui = 13.6 V / Pi = 0.69 W / Ci = Li = negligibly small			
Start-up time typ. [s]	8 (2...15)			
Reaction time typ. [s]	2 (1...15)			
Compressive strength [bar]	6			
Housing material	AISI 316 Ti • different materials on request			
Protection [EN 60529]	IP 67			
Connection	M12 connector			

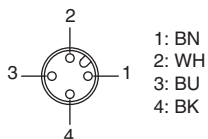

Accessories transition parts SDA M16-..., see page 1.95 tube fitting SV-M... on request

Ex - Probe • Category 1/2 - 1 • Zone 0/1 - 20

Series STS

Gas-Ex Category 1/2

Ex II 1/2 G Ex ia IIC T4 Ga/Gb

Dust-Ex Category 1

Ex II 1 D Ex ia IIIC T120 °C Da



Design	G1/2	
Dimensions		
Detection	[m/s]	air 2...25
Sensor length	[mm]	65
Connection		fixed cable
ID-No.		P11152
Type		STS 212 K
Ex area of use		Gas: Zone 0/1 / Dust: Zone 20
Certificate No.		TÜV 98 ATEX 1298 X
Ex marking	Gas:	Ex II 1/2 G Ex ia IIC T4 Ga/Gb
	Dust:	Ex II 1 D Ex ia IIIC T120 °C Da
Ambient temperature and medium temperature	Gas:	T4: -20 ≤ Ta ≤ +60 T3: -20 ≤ Ta ≤ +60
	Dust:	-20 ≤ Ta ≤ +60
Maximum values		Ui = 13.65 V / li = 200 mA / Pi = 0.69 W / Ci = 0.27 nF / Li = 1.30 µH
Start-up time typ.	[s]	10...40
Reaction time typ.	[s]	5 (2...30)
Compressive strength	[bar]	10
Housing material		AISI 316 Ti • different materials on request
Protection	[EN 60529]	IP 68
Connection		2 m PUR-cable 4x0.25 mm ²
		M12 connector
		(probes with cable length > 2 m are available on request)
Notice		for the connection to amplifiers SZA..., SEA..., SS 400, see page 1.85 - 1.88

Ex - Probe • Category 1/2 - 1 • Zone 0/1 - 20

Series STS



Gas-Ex Category 1/2

Ex II 1/2 G Ex ia IIC T6 Ga/Gb

Dust-Ex Category 1

Ex II 1 D Ex ia IIIC T105 °C Da

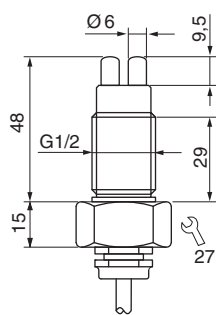
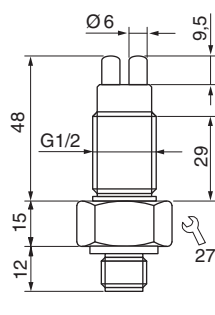

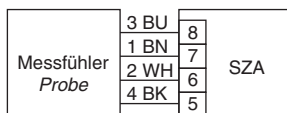
Design	G1/2	
Dimensions		
Detection range [m/s]	air 2...25	air 2...25
Sensor length [mm]	48	48
Connection	fixed cable	plug
ID-No.	P11153	P11207
Type	STS 215 K	STS 215 S
Ex area of use	Gas: Zone 0/1 / Dust: Zone 20	
Certificate No.	TÜV 98 ATEX 1298 X	
Ex marking	Gas: Ex II 1/2 G Ex ia IIC T6 Ga/Gb	Dust: Ex II 1 D Ex ia IIIC T105 °C Da
Ambient temperature and medium temperature [°C]	Gas:	T6: $-20 \leq Ta \leq +35$ T5: $-20 \leq Ta \leq +50$ T4: $-20 \leq Ta \leq +60$ T3: $-20 \leq Ta \leq +60$
	Dust:	$-20 \leq Ta \leq +60$
Maximum values	$U_i = 13.65 \text{ V}$ / $I_i = 200 \text{ mA}$ / $P_i = 0.69 \text{ W}$ / $C_i = 0.27 \text{ nF}$ / $L_i = 1.30 \text{ }\mu\text{H}$	
Start-up time typ. [s]	5...20	
Reaction time typ. [s]	3 (2...30)	
Compressive strength [bar]	10	
Housing material	AISI 316 Ti • different materials on request	
Protection [EN 60529]	IP 68	IP 67
Connection	2 m PUR-cable 4x0.25 mm ²	M12 connector
		
	(probes with cable length > 2 m are available on request)	
Notice	for the connection to amplifiers SZA..., SEA..., SS 400, see page 1.85 - 1.88	

Ex - Probe • Category 1/2 - 1 • Zone 0/1 - 20

Series STS

Gas-Ex Category 1/2

Ex II 1/2 G Ex ia IIC T6 Ga/Gb

Dust-Ex Category 1

Ex II 1 D Ex ia IIIC T105 °C Da



Extended temperature range

Design	G1/2																											
Dimensions																												
Detection range [m/s]	air 2...25																											
Sensor length [mm]	48																											
Connection	fixed cable																											
ID-No.	P11212																											
Type	STS 215 KH																											
Ex area of use	Gas: Zone 0/1 / Dust: Zone 20	Gas: Zone 1 / Dust: Zone 21																										
Certificate No.	TÜV 98 ATEX 1298 X																											
Ex marking	Gas: Ex II 1/2 G Ex ia IIC T6 Ga/Gb	Dust: Ex II 1 D Ex ia IIIC T105 °C Da																										
Ambient temperature and medium temperature [°C]	Gas: T6: -20 ≤ Ta ≤ +35 T5: -20 ≤ Ta ≤ +50 T4: -20 ≤ Ta ≤ +60 T3: -20 ≤ Ta ≤ +60 Dust: -20 ≤ Ta ≤ +60	Gas: T6: +10 ≤ Ta ≤ +35 T5: +10 ≤ Ta ≤ +50 T4: +10 ≤ Ta ≤ +85 T3: +10 ≤ Ta ≤ +120 Dust: -20 ≤ Ta ≤ +85																										
Maximum values	Ui = 13.65 V / li = 200 mA / Pi = 0.69 W / Ci = 0.27 nF / Li = 1.30 µH																											
Start-up time typ. [s]	5...20																											
Reaction time typ. [s]	3 (2...30)																											
Compressive strength [bar]	10																											
Housing material	AISI 316 Ti • different materials on request																											
Protection [EN 60529]	IP 68																											
Connection	2 m FEP-cable 4x0.25 mm ²																											
	<table border="1"> <tr><td>Messfühler</td><td>1 BN</td><td>d26</td><td rowspan="4">SEA</td></tr> <tr><td>Probe</td><td>2 WH</td><td>d28</td></tr> <tr><td></td><td>3 BU</td><td>d30</td></tr> <tr><td></td><td>4 BK</td><td>d32</td></tr> </table>	Messfühler	1 BN	d26	SEA	Probe	2 WH	d28		3 BU	d30		4 BK	d32	<table border="1"> <tr><td>Messfühler</td><td>3 BU</td><td>8</td><td rowspan="4">SZA</td></tr> <tr><td>Probe</td><td>1 BN</td><td>7</td></tr> <tr><td></td><td>2 WH</td><td>6</td></tr> <tr><td></td><td>4 BK</td><td>5</td></tr> </table>	Messfühler	3 BU	8	SZA	Probe	1 BN	7		2 WH	6		4 BK	5
Messfühler	1 BN	d26	SEA																									
Probe	2 WH	d28																										
	3 BU	d30																										
	4 BK	d32																										
Messfühler	3 BU	8	SZA																									
Probe	1 BN	7																										
	2 WH	6																										
	4 BK	5																										
	(probes with cable length > 2 m are available on request)																											
Notice	for the connection to amplifiers SZA..., SEA..., SS 400, see page 1.85 - 1.88																											

Ex - Compact models • Category 3 • Zone 22

Series LG - Air flow controller

Dust-Ex Category 3

Ex II 3D IP65 T120 °C X

DC 24 V

PNP output

Analog output

Detection range 0.5...15 m/s



Design	M18x1	
Dimensions		
Detection range [m/s]	air 0.5...15	
Output	 PNP	 4...20 mA
ID-No.	P11311	P11312
Type	LG 518 GSP-EX22 *	LG 518 GA-EX22 *
Ex area of use	Dust: Zone 22	
Ex marking	Ex II 3D IP65 T120 °C X	Ex II 3D IP65 T120 °C X
Supply voltage [V]	24 DC ±20%	
Switching current [mA]	200	-
Load RL [Ω]	-	200...500
Current consumption [mA]	70	
Ambient temperature [°C]	-10 ≤ Ta ≤ +60	
Medium temperature [°C]	0 ≤ Ta ≤ +60	
Start-up time [s]	20...40	
Reaction time typ. [s]	2	3
Housing material	PBT / Br-Ni	
Display flow	LED	
Protection [EN 60529]	IP 65	
Connection	2 m PVC-cable 3x0.5 mm ²	
 cUL US LISTED		
Accessories	flange Ø20 (Z01106), see page 1.94	

Series LNZ - Air flow controller

Dust-Ex Category 3

Ex II 3D IP 65 T 90 °C X

AC 230 V • AC 115 V • DC 24 V

Relais output

Analog output

Detection range 0.5...30 m/s



Design	G1/2		G1/2	
Dimensions				
Detection range [m/s]	air 0.5...30		air 0.5...30	air 0.5...30
Output				
ID-No.	P11303	P11304	P11305	P11306 *
Type	LNZ 450 WR1-EX22	LNZ 450 WR2-EX22	LNZ 450 GR-EX22	LNZ 450 GA-EX22
Ex area of use	Dust: Zone 22		Dust: Zone 22	
Ex marking	Ex II 3D IP 65 T 90 °C X		Ex II 3D IP 65 T 90 °C X	
Supply voltage [V]	115 AC ±15%	230 AC ±15%	24 DC ±20%	24 DC ±15%
Current consumption [mA]	60	30	80	80
Current output [mA]	-		-	4...20
Load RL [Ω]	-		-	200...500
Switching voltage [V]	250 AC / 60 DC		250 AC / 60 DC	
Switching current [A]	4 AC / 4 DC		4 AC / 4 DC	
Switching power max.	1000 VA / 60 W		1000 VA / 60 W	
Ambient temperature [°C]	-10 ≤ Ta ≤ +60		-10 ≤ Ta ≤ +60	
Medium temperature [°C]	0 ≤ Ta ≤ +60		0 ≤ Ta ≤ +60	
Start-up time typ. [s]	10...90		10...90	
Reaction time typ. [s]	2...30		2...30	
Compressive strength [bar]	30		30	
Material	housing: PBT sensor: AISI 303		housing: PBT sensor: AISI 303	
Display flow	LED-array		LED-array	
Protection [EN 60529]	IP 65		IP 65	
Connection	2 m PVC-cable 5x0.5 mm ²		2 m PVC-cable 5x0.5 mm ²	2 m PVC-cable 3x0.5 mm ²
* US LISTED				

Ex - Compact models • Category 3 • Zone 22

Serie LN - Air flow controller

Dust-Ex Category 3

Ex II 3D IP65 T90 °C X

AC 230 V • AC 115 V • DC 24 V

Relais output

Analog output

Detection range 0.5...30 m/s



Design	G1		G1	
Dimensions				
Detection range [m/s]	air 0,5...30		air 0,5...30	air 0,5...30
Output				
ID-No.	P11307	P11308	P11309	P11310 *
Type	LN 450 WR1-EX22	LN 450 WR2-EX22	LN 450 GR-EX22	LN 450 GA-EX22
Ex area of use	Dust: Zone 22		Dust: Zone 22	
Ex marking	Ex II 3D IP 65 T 90 °C X		Ex II 3D IP 65 T 90 °C X	
Supply voltage [V]	115 AC ±15%	230 AC ±15%	24 DC ±20%	24 DC ±15%
Current consumption [mA]	60	30	80	80
Current output [mA]	-		-	4...20
Load RL [Ω]	-		-	200...500
Switching voltage [V]	250 AC / 60 DC		250 AC / 60 DC	
Switching current [A]	4 AC / 4 DC		4 AC / 4 DC	
Switching power max.	1000 VA / 60 W		1000 VA / 60 W	
Ambient temperature [°C]	-10 ≤ Ta ≤ +60		-10 ≤ Ta ≤ +60	
Medium temperature [°C]	0 ≤ Ta ≤ +60		0 ≤ Ta ≤ +60	
Start-up time typ. [s]	10...90		10...90	
Reaction time typ. [s]	2...30		2...30	
Compressive strength [bar]	3		3	
Material	housing: PBT sensor: AISI 303 / Delrin		housing: PBT sensor: AISI 303 / Delrin	
Display flow	LED-array		LED-array	
Protection [EN 60529]	IP 65		IP 65	
Connection	2 m PVC-cable 5x0.5 mm ²		2 m PVC-cable 5x0.5 mm ²	2 m PVC-cable 3x0.5 mm ²
*				

- Amplifier

Series SZA

II (1) GD [Ex ia] IIC

AC 230 V • AC 115 V

DC 24 V

Relay output

Analog output

Cable break and short circuit monitoring

Turn off delay



Ausführung	SZA 400 Ex...			SZA 400 GA-Ex
Abmessungen				
ID-No.	P10706	P10707	P10708	P11257
Type	SZA 400 Ex-230	SZA 400 Ex-115	SZA 400 Ex-24	SZA 400 GA-Ex
Output				
Supply voltage [V]	230 AC ±10%	115 AC ±10%	24 DC ±15%	24 DC ±15%
Ex marking	II (1) GD [Ex ia] IIC			II (1) GD [Ex ia] IIC
Certificate No.	TÜV 96 ATEX 1097			TÜV 02 ATEX 1821
Maximum values	U _o = 12.6 V I _o = 200 mA R _i = 68.5 Ω C _o = 170 nF L _o = 0.5 mH			U _o = 13.65 V I _o = 200 mA P _o = 690 mW C _o = 170 nF L _o = 0.5 mH
Turn off delay [s]	0...25			-
Output	relay / change-over			analog
Switching voltage [V]	250 AC / 60 DC			-
Switching current [A]	4 AC / 0.5 DC			-
Switching power	cos φ >0.7 / L/R <200 ms			-
Current output [mA]	-			4...20 DC
Load resistance R _L [Ω]	-			200...500
Ambient temperature [°C]	-20 ≤ T _a ≤ +60			
Protection [EN 60529]	terminal IP 20 / housing IP 40			
Connection	terminal screws			

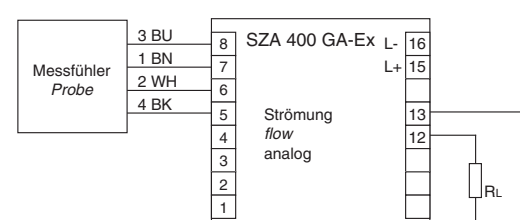
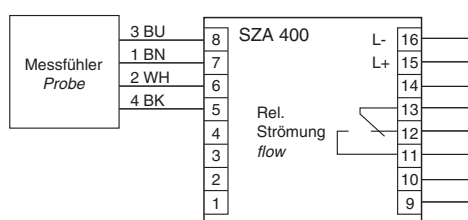

Ex - Amplifier

Series SEA

Ex II (1) GD [Ex ia] IIC

DC 24 V

Relay output

Analog output

Time delay on/off programmable



Design	SEA 400 Ex-24	SEA 401 Ex-24	SEA 405 GA-Ex
--------	---------------	---------------	---------------

Dimensions

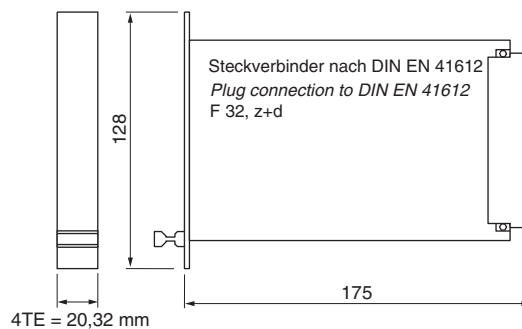

ID-No.	P10705	P10709	P11253
Type	SEA 400 Ex-24	SEA 401 Ex-24	SEA 405 GA-Ex
Supply voltage [V]	24 DC $\pm 15\%$		24 DC $\pm 15\%$
Ex marking	Ex II (1) GD [Ex ia] IIC		Ex II (1) GD [Ex ia] IIC
Certificate No.	TÜV 97 ATEX 1182X		TÜV 01 ATEX 1678X
Maximum values	U _o = 13.65 V I _o = 200 mA R _i = 68.5 Ω P _o = 0.69 W C _o = 150 nF L _o = 0.87 mH		U _o = 13.65 V I _o = 200 mA R _i = 68.5 Ω P _o = 0.69 W C _o = 150 nF L _o = 0.87 mH
Output 1 (relay/change-over)	flow		analog 4...20 mA
Output 2 (relay/change-over)	temperature	failure	-
Load R _L [Ω]	-		200...500
Switching voltage [V]	30 AC / 36 DC		-
Switching current [A]	2		-
Switching power max.	60 VA / 50 W		-
Ambient temperature [°C]	-20 \leq T _a \leq +60		-20 \leq T _a \leq +60
Protection [EN 60529]	IP 20		IP 20

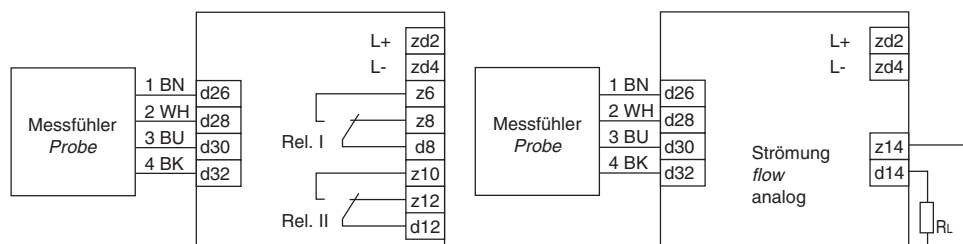

Ex - Amplifier

Series SS

Dust II 2D T92 °C IP65

Gas II (1) 2G Ex em [ia] IIC T6

Installation in Zone 1/21

Adjustment in Zone 1/21

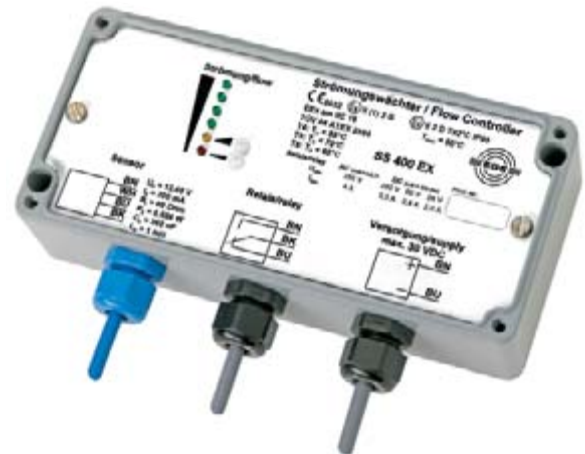

Design SS 400 Ex

Dimensions

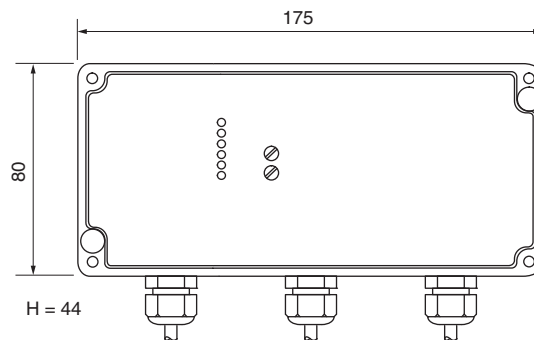

ID-No.	P11292				
Type	SS 400 Ex-24				
Supply voltage [V]	24 DC ±15%				
Ex marking	Gas:	II (1) 2G Ex em [ia] IIC T6			
	Dust:	II 2D T92 °C IP65			
Certificate No.	TÜV 04 ATEX 2554				
Ambient temperature [°C]	Gas:	T6: -20 ≤ Ta ≤ +60			
		T5: -20 ≤ Ta ≤ +70			
		T4: -20 ≤ Ta ≤ +85			
	Dust:	-20 ≤ Ta ≤ +60			
Maximum values	U _o = 13.65 V / I _o = 200 mA / P _o = 688 mW				
External capacitance C _o	IIC: 360 nF		IIB: 1300 nF		IIA: 3000 nF
External inductance L _o	IIC: 1 mH		IIB: 4.7 mH		IIA: 10 mH
Output relay	increased safety				intrinsically safe
Switching voltage [V]	250 AC	250 DC	60 DC	24 DC	Ex ib IIC 30 V
Switching current [A]	2 AC	0.3 DC	0.8 DC	2 DC	IIC: 0.1 DC IIB: 0.25 DC IIA: 0.34 DC
Switching power	cos φ ≥ 0,7 / L/R ≤ 200 ms				
Protection [EN 60529]	IP 65				
Connection	sensor: 2 m PUR-cable, blue, 4x0.25 mm ² relay/supply: 2 m PVC-cable, 3x0.5 mm ² , 2x0.5 mm ²				

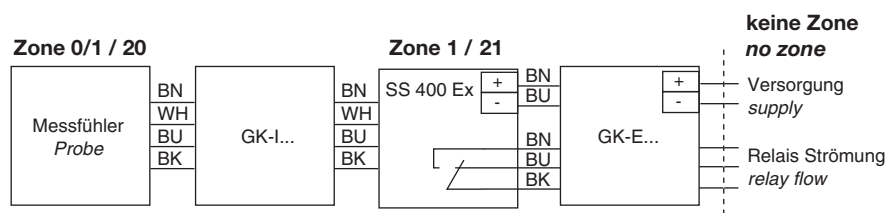

Accessories housing for screw terminals series GK..., see page 1.89

Ex - Amplifier unit • Zone 1

Series SSAE

Amplifier unit Dust / Gas Ex

Adjustment, display and installation in Zone 1/21

Protective housing with inspection glass

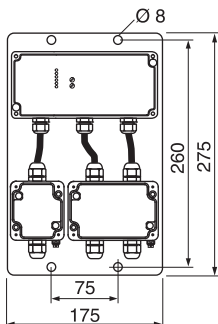
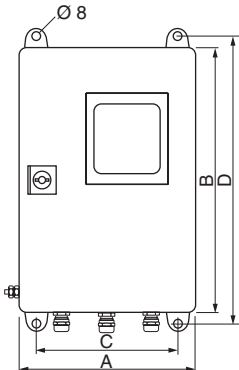

Design	Amplifier unit SSAE	Protective housing GAM
Dimensions		
ID-No.	P11302	Z01184
Type	SSAE 400	GAM 2030
Components of amplifier unit		
Amplifier	type SS 400 Ex-24	
Supply voltage [V]	24 DC ±15%	
Ex marking	Gas: Ex II (1) 2G Ex em [ia] IIC T6 Dust: Ex II 2D IP 65 T 92 °C	
Technical data	see page 1.87	
Connection box probes	type GKI 60	
Ex marking	Gas: Ex II 2G Ex ia IIC T6 Dust: Ex II 2D IP 65 T 75 °C	
Technical data	see page 1.89	
Connection box switching outputs	type GKE 100	
Ex marking	Gas: Ex II 2G Ex e II T6 Dust: Ex II 2D IP 65 T 75 °C	
Technical data	see page 1.89	
Protection [EN 60529]	IP 65	IP 66
Material	housing and mounting plate aluminium	sheet steel case, lacquered
Terminals cable diameter [mm]	4-8	4-8

Protective housing overview

Type	ID-No.	A	B	C	D
GAM 1530	Z01183	150	300	110	320
GAM 2030	Z01184	200	300	160	320
GAM 3030	Z01185	300	300	260	320
GAM 3040	Z01186	300	400	260	420

The components of the amplifier unit SSAE 400 are mounted on an aluminium plate ready for connection and can be installed without a protective housing within Zone 1/21. The supply cables must be laid in increased safety. A suitable protective housing (GAM 2030 type) can be included in the delivery as an accessory. The mounting plate is designed to fit precisely.

- Housing for screw terminals

Series GK...

- II 2G Ex e II T6
- II 2G Ex ia IIC T6
- II 2G Ex e [ia] IIC T6
- II 2D IP65 T 75 °C

For the connection of supply and signal lines in Zone 1/21



Design	GK...				
Dimensions					
ID-No.	Z01168	Z01169	Z01170	Z01171	Z01172
Type	GK-E 60	GK-E 100	GK-I 60	GK-I 100	GK-EI 100
Amount of terminals	4	8	4	8	4 Ex e + 4 Ex ia
Dimensions [mm]	58x64	98x64	58x64	98x64	98x64
Protection	increased safety		intrinsically safe		intrinsically safe + increased safety
Ex marking	II 2G Ex e II T6 II 2D IP65 T 75 °C		II 2G Ex ia IIC T6 II 2D IP65 T 75 °C		II 2G Ex e [ia] IIC T6 II 2D IP65 T 75 °C
Certificate No.	BVS 05 ATEX E 022 X				
Ambient temperature [°C]	Gas: T4, T5, T6: $-20 \leq T_a \leq +70$ Dust: $-20 \leq T_a \leq +70$				
Rated voltage [V]	275				
Rated current [A]	2				
Cross section wires	single wire: 0.5...2.5 mm ² / multistrand: 0.5...1.5 mm ²				
Terminals cable diameter [mm]	4...8				
Housing material	aluminium				
Protection [EN 60529]	IP 65				
Connection	terminal compartment				

The housing for screw terminals type GK... is designed for the connection of intrinsically safe and/or non-intrinsically safe circuits in explosion-hazardous areas of category. Outside of the housing, the lines must be installed permanently; further provisions must be observed if required.

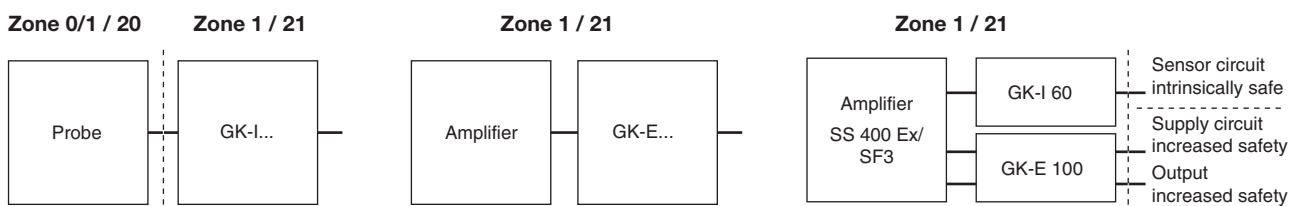

Ex - Lightning protection • Zone 0

Gas Ex II 2 (1) G Ex ia IIC T4

The lightning protection SBGX 01 is placed between the sensor and the amplifier.
Lightning overvoltage is discharged to earth.



Design	SBGX 01
--------	---------

Dimensions

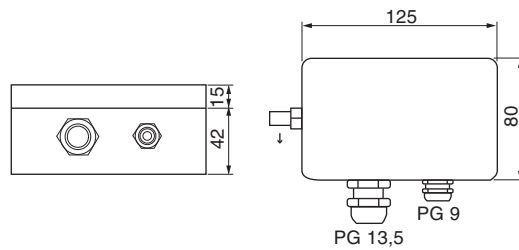

ID-No.	Z01007
Type	SBGX 01
Ex marking	Ex II 2 (1) G Ex ia IIC T4
Certificate No.	TÜV 03 ATEX 2073
Ambient temperature [°C]	T4: -20 ≤ Ta ≤ +120
Maximum values	Ui = 45 V Ii = 3.3 A Pi = 1.3 W Ci = negligibly small Li = negligibly small
Housing material	aluminium
Protection [EN 60529]	IP 67
Connection	terminal compartment

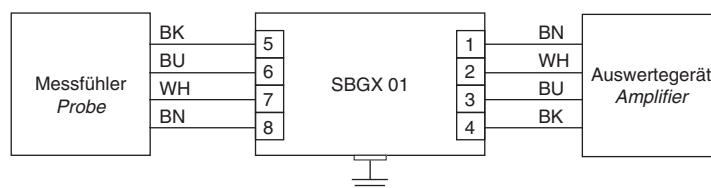

Accessories • M12 connector

System SL

Finished cable plug housing
Self locking screw plug
Protection IP 67

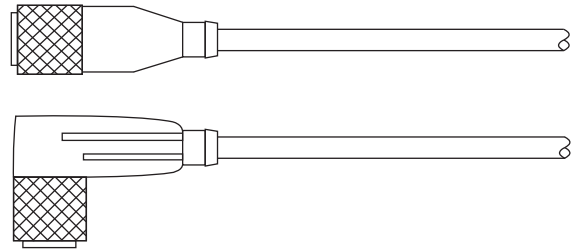

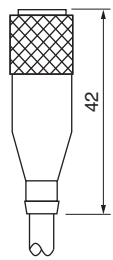
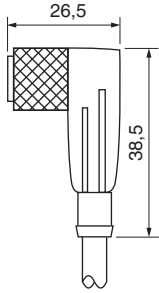
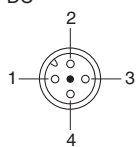
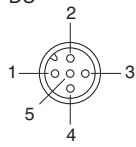
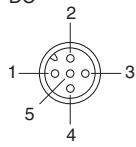
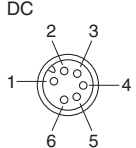
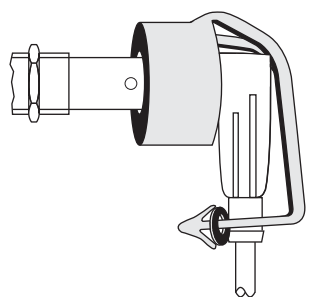
Cable plug housing	Pin-assignment	Plug-lock
<div style="display: flex; justify-content: space-around;"> <div style="text-align: center;"> <p>straight</p>  <p>42</p> <p>SLG...</p> </div> <div style="text-align: center;"> <p>angular</p>  <p>26,5 38,5</p> <p>SLW...</p> </div> </div>	<div style="display: flex; justify-content: space-around;"> <div style="text-align: center;"> <p>DC</p>  <p>3-wire 1: BN 2: - 3: BU 4: BK</p> </div> <div style="text-align: center;"> <p>DC</p>  <p>4-wire 1: BN 2: WH 3: BU 4: BK</p> </div> <div style="text-align: center;"> <p>DC</p>  <p>5-wire 1: BN 2: WH 3: BU 4: BK 5: GY</p> </div> <div style="text-align: center;"> <p>DC</p>  <p>6-wire 1: BN 2: WH 3: BU 4: BK 5: GY 6: PK</p> </div> </div> <p style="text-align: center;">DC</p>	 <p style="text-align: center;">PL-M12</p>

TYPE	ID-NO.	DESIGN
SLG 3-2	Z01076	Cable plug housing straight, 2 m cable 3x0.34 mm ² max. 250 V / 4 A
SLG 3-5	Z01077	Cable plug housing straight, 5 m cable 3x0.34 mm ² max. 250 V / 4 A
SLW 3-2	Z01078	Cable plug housing angular, 2 m cable 3x0.34 mm ² max. 250 V / 4 A
SLW 3-5	Z01079	Cable plug housing angular, 5 m cable 3x0.34 mm ² max. 250 V / 4 A
SLW 3-2-LED	Z00052	Cable plug housing angular, 2 m cable 3x0.34 mm ² max. 250 V / 4 A PNP with LED
SLG 4-2	Z00445	Cable plug housing straight, 2 m cable 4x0.25 mm ² max. 250 V / 4 A
SLG 4-5	Z00449	Cable plug housing straight, 5 m cable 4x0.25 mm ² max. 250 V / 4 A
SLW 4-2	Z00446	Cable plug housing angular, 2 m cable 4x0.25 mm ² max. 250 V / 4 A
SLW 4-5	Z00450	Cable plug housing angular, 5 m cable 4x0.25 mm ² max. 250 V / 4 A
SLW 4-2-LED	Z01157	Cable plug housing angular, 2 m cable 4x0.25 mm ² max. 250 V / 4 A PNP with LED
SLG 5-2	Z01150	Cable plug housing straight, 2 m cable 5x0.34 mm ² max. 60 V / 2 A
SLW 5-2	Z01151	Cable plug housing angular, 2 m cable 5x0.34 mm ² max. 60 V / 2 A
SLG 6-2	Z01197	Cable plug housing straight, 2 m cable 6x0.25 mm ² max. 36 V / 2 A
SLW 6-2	Z01198	Cable plug housing angular, 2 m cable 6x0.25 mm ² max. 36 V / 2 A
PL-M12	Z01182	Plug-lock for sensors in Ex areas

DATA

Thread	M12x1	Contact resistance	≤ 5 mΩ
Material	PVC	Insulation resistance	>10 ⁹
Protection	IP 67	Testing voltage	2.0 KV eff. / 5 and 6 pol. 1.5 KV eff.
Temperature range	-25...+80 °C		

Note

Sensors with NC output are connected to 4 pole cable plug housings. In this case, the break output is connected to the white lead (connection 2).

Accessories • M12 connector

System SB

Cable plug user-assembled
Great variety of cables
Protection IP 67



Cable plug housing straight

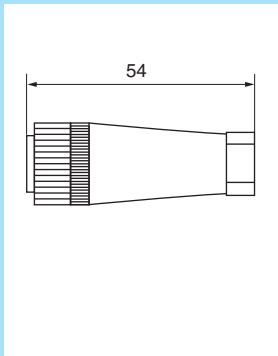

SBG...

Cable plug housing angular

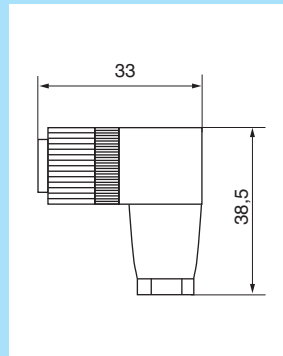

SBW...

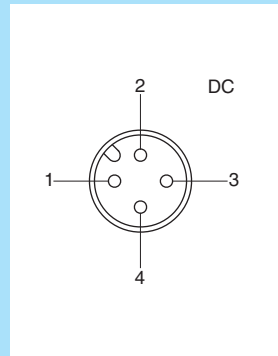

SBG.../SBW...

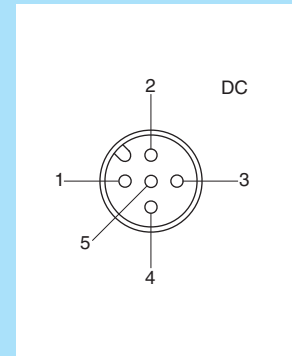

SBG 5.../SBW 5...

TYPE	ID-NO.	DESIGN
SBG-DC	Z01060	DC-Cable plug housing M12x1, straight 4-pol user assembled 30 VDC, 3 A
SBW-DC	Z00038	DC-Cable plug housing M12x1, angular 4-pol user assembled 30 VDC, 3 A
SBG 5-DC	Z01146	DC-Cable plug housing M12x1, straight 5-pol user assembled 30 VDC, 1 A
SBW 5-DC	Z01147	DC-Cable plug housing M12x1, angular 5-pol user assembled 30 VDC, 1 A

PREFERRED CABLE

PVC 205	Z01061	PVC-cable 2x0.5 mm ²	Lead colour coding: BN/BU
PVC 205B	Z01062	PVC-cable 2x0.5 mm ² , blue cable covering	Lead colour coding: BN/BU
PVC 305	Z01063	PVC-cable 3x0.5 mm ²	Lead colour coding: BN/BU/BK
PVC 434	Z01066	PVC-cable 4x0.34 mm ²	Lead colour coding: BN/BU/BK/WH
PVC 405	Z01067	PVC-cable 4x0.5 mm ²	Lead colour coding: BN/BU/BK/WH
PVC 505	Z01116	PVC-cable 5x0.5 mm ²	Lead colour coding: BN/BU/BK/WH/GY
PUR 425S	Z01069	PUR-cable 4x0.25 mm ² , shielded	Lead colour coding: BN/BU/BK/WH
PUR 425BS	Z01070	PUR-cable 4x0.25 mm ² , shielded, blue cable covering	Lead colour coding: BN/BU/BK/WH
	Z01074	Finishing of cable plug housing	
	Z01075	Finishing of cable plug housing and cable extremity	

Note

Different cables on request.

Code: BK = black BN = brown BU = blue GN = green YE = yellow GY = grey PK = pink WH = white

Accessories • cable

TYPE	ID-NO.	MATERIAL/SHEAT	Ø _A [mm]*	WIRE SPECIFICATION	COLOUR
PVC205	Z01061	PVC, grey	5.2	2x0.5 mm ²	BU, BN
PVC205B	Z01062	PVC, blue	4.4	2x0.5 mm ²	BU, BN
PVC275	Z01086	PVC, grey	6.0	2x0.75 mm ²	BU, BN
PVC275BS	Z01108	PVC, blue	6.3	2x0.75 mm ² shielded	numbered cable
PVC334	Z01109	PVC, grey	4.5	3x0.34 mm ²	BU, BN, BK
PVC305E	Z01064	PVC, grey	5.2	3x0.5 mm ²	BU, BN, GN/YE
PVC305	Z01063	PVC, grey	5.2	3x0.5 mm ²	BU, BN, BK
PVC305B	Z01167	PVC, blue	5.2	3x0.5 mm ²	BU, BN, BK
PVC375	Z01065	PVC, grey	6.0	3x0.75 mm ²	numbered cable
PVC375E	Z01111	PVC, grey	6.0	3x0.75 mm ²	BU, BN, GN/YE
PVC425	Z01110	PVC, grey	4.3	4x0.25 mm ²	BU, BN, BK, WH
PVC434	Z01066	PVC, grey	4.5	4x0.34 mm ²	BU, BN, BK, WH
PVC405	Z01067	PVC, grey	5.5	4x0.5 mm ²	BU, BN, BK, WH
PVC475E	Z01113	PVC, grey	6.5	4x0.75 mm ²	BU, BN, BK, GN/YE
PVC475BS	Z01114	PVC, blue	7.3	4x0.75 mm ² shielded	numbered cable
PVC505	Z01116	PVC, grey	5.8	5x0.5 mm ²	BU, BN, WH, BK, GY
PVC705	Z01117	PVC, grey	6.6	7x0.5 mm ²	BU, BN, WH, GN/YE, GY, PK
PUR334	Z01156	PUR, grey	5.0	3x0.34 mm ²	BU, BN, BK
PUR375	Z01068	PUR, black	6.0	3x0.75 mm ² -40°C	BU, BN, BK
PUR425S	Z01069	PUR, grey	5.0	4x0.25 mm ² shielded	BU, BN, WH, BK
PUR425BS	Z01070	PUR, blue	5.0	4x0.25 mm ² shielded	BU, BN, WH, BK
PUR405	Z01112	PUR, black	5.0	4x0.5 mm ²	BU, BN, WH, BK
PUR405BS	Z01173	PUR, blue	6.2	4x0.5 mm ² shielded	BU, BN, WH, BK
PUR475SE	Z01118	PUR, grey	9.0	4x0.75 mm ² shielded	numbered cable
PUR410E	Z01119	PUR, orange	8.0	4x1.0 mm ²	BU, BN, BK, GN/YE
FEP375S	Z01126	FEP, red	5.0	3x0.75 mm ² shielded	BU, BN, BK
FEP334	Z01071	FEP, red	3.8	3x0.34 mm ²	BU, BN, BK
FEP425S	Z01073	FEP, red	4.1	4x0.25 mm ² shielded	BU, BN, BK, WH
FEP425	Z01072	FEP, red	3.7	4x0.25 mm ²	BU, BN, BK, WH
FEP425BS	Z01125	FEP, blue	4.1	4x0.25 mm ² shielded	BU, BN, BK, WH
FEP375	Z01165	FEP, red	4.2	3x0.75 mm ²	BU, BN, GN/YE
Silikon375E	Z01121	Silicone, red	6.0	3x0.75 mm ²	BU, BN, GN/YE
Silikon475E	Z01122	Silicone, red	6.3	4x0.75 mm ²	BU, BN, BK, GN/YE
Silikon475SE	Z01115	Silicone, red	8.8	4x0.75 mm ² shielded	BU, BN, BK, GN/YE
Silikon305	Z01143	Silicone, red	5.5	3x0.5 mm ²	BU, BN, BK
PVC705SE	Z01123	PVC-transparent	9.2	7x0.5 mm ² shielded	numbered cable, GN/YE

*Tolerance of diameter ±0,4 mm

Code: BK = black BN = brown BU = blue GN = green YE = yellow GY = grey PK = pink WH = white

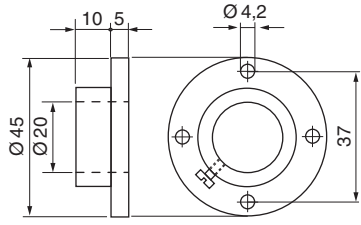
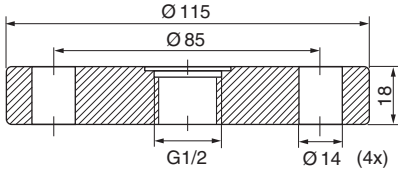
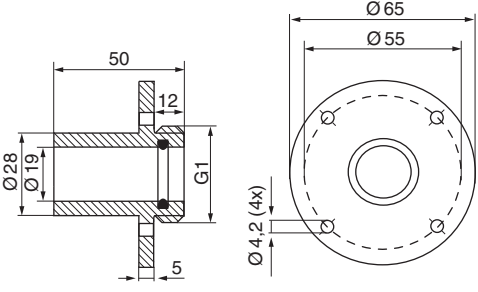
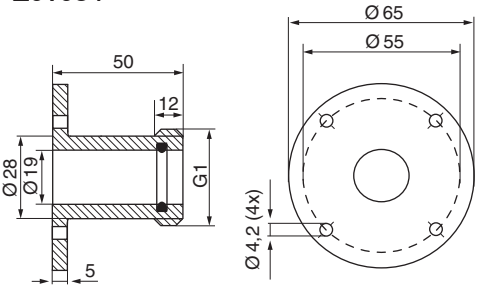
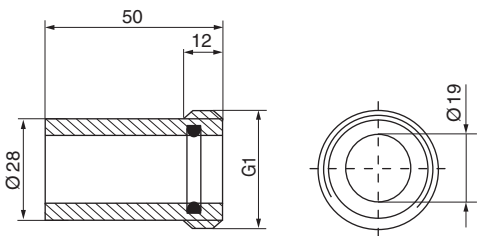
TYPE	ID-NO.	DIMENSIONS	DESIGN
Flange - Ø 20	Z01106		Plastic - flange with drilled hole Ø 20 mm for sensors type LN 520
Flange DN25/PN40	Z01001		Flange AISI 316 Ti (1.4571) EN 1092-1/05 A (DIN 2527) with central thread G1/2 for sensors type ST... with G1/2
A501	Z01033		Thread sleeve of brass, nickel-plated L=50 mm, G1 for sensors type LN...
A502	Z01034		Thread sleeve of brass, nickel-plated L=50 mm, G1 for sensors type LN...
A503	Z01035		Welding sleeve of FE 360 B (1.0037), L=50 mm, G1 for sensors type LN...

Accessories • Product section 1

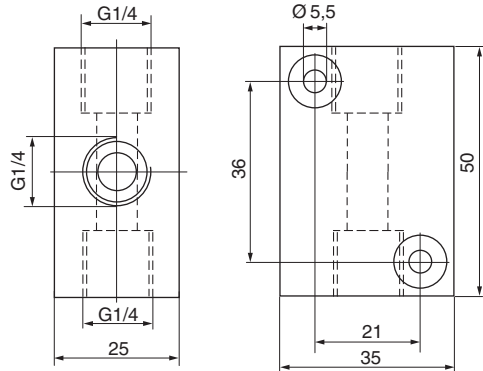
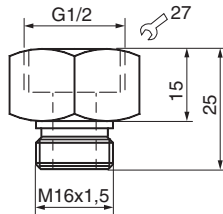
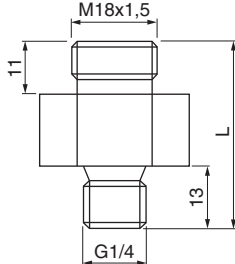
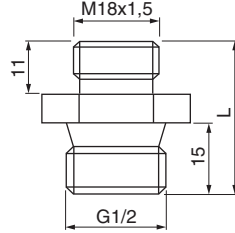
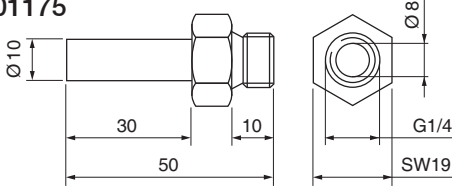
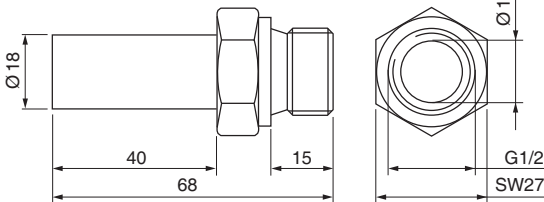
TYPE	ID-NO.	DIMENSIONS	DESIGN
SIA G1/4 - 1/4 - 1/4	Z01018		<p>Adapter for G1/4-sensors with G1/4-pipe connections</p> <p>Material: AISI 316 Ti Sensors: STK 412...</p> <p>Massflow down to 10 ml/min</p> <p>(additional models on request)</p>
SDA M16 - G1/2	Z01017		<p>Transition piece for inline-sensors SD... to G1/2-female thread</p> <p>Material: AISI 316 Ti</p> <p>(additional models on request)</p>
SDA-SCS-G1/4	Z01200 L = 39 mm		<p>Screw-in adapter G1/4 for flow sensors SCS, SNS, SNTS and ST418</p> <p>Material: AISI 316 Ti</p>
SDA-SCS-G1/2	Z01201 L = 30 mm		<p>Screw-in adapter G1/2 for flow sensors SCS, SNS, SNTS and ST418</p>
SDA-SCS-G1/2-L37	Z01208 L = 37 mm		<p>Material: AISI 316 Ti</p>
SDA G1/4-Ø10-L050	Z01175		<p>Adapter G1/4 for flow sensors inline-digital display SDN 5.../1..., SDV 652..., SDI 852/1...</p>
SDA G1/2-Ø18-L068	Z01176		<p>Adapter G1/2 for flow sensors inline-digital display SDN 552/3...</p>



**Headquarters
EGE-Elektronik
Spezial-Sensoren GmbH**

Ravensberg 34
D-24214 Gettorf
Tel. +49 (0) 4346 / 41580
Fax +49 (0) 4346 / 5658

Internet: www.ege-elektronik.com



EGE-Elektronik ApS
Forstallé 79
DK-6200 Aabenraa
Tel. +45 70207271
Fax +45 70207272



EGE-Specialsensorer AB
Box 137
S-51223 Svenljunga
Tel. +46 32512060
Fax +46 32512064



Stork AS
Brynsveien 100
N-1352 Kolsås
Tel. +47 67176400
Fax +47 67176401



Vision Systems OY
PL353
FI-40101 Jyväskylä
Tel. +358 (0)10 322 7100
Fax +358 (0)10 322 7119



Molex France
18 Parc Burospace
F-91571 Bièvres Cedex
Tel. +33 2 32 96 04 28
Fax +33 2 32 96 04 21



Cematic-Electric B.V.
Postbus 777
NL-7550 AT Hengelo
Tel. +31 742433422
Fax +31 742913333



ICM Ital Control Meters Srl
Via della Valle 67
I-20048 Carate Brianza (Mi)
Tel. +39 0362 8052 00
Fax +39 0362 8052 01



Bibus Spain, S. L.
Rua do Arroncal, Vial C – Nave 4A
ES-36350 Nigran
Tel. +34 986 247286
Fax +34 986 209247



Powelectrics Limited
Sandy Hill Park, Sandy Way
Amington, Tamworth
GB-Staffordshire B77 4DU
Tel. +44 1827310666
Fax +44 1827310999



Bachofen AG
Ackerstraße 42
CH-8610 Uster
Tel. +41 449441111
Fax +41 449441233



VWR International GmbH
Graumannsgasse 7
A-1150 Wien
Tel. +43 1 97 002 - 0
Fax +43 1 97 002 - 600



Countapulse Controls (PTY) LTD.
P.O.B. 40393
ZA-2022 Cleveland
Tel. +27 116157556
Fax +27 116157513



HITECH Ltd.
1-35-2 Simouma, Setagaya,
JPN-Tokyo 154-0002
Tel. +81 35430 2301
Fax +81 35430 2302



Micromax S&A P/L
Unit 2 106-110 Beaconsfield Street
AUS-Silverwater NSW 2128
Tel. +61 1300 362626
Fax +61 1300 017100



Protek Teknik Elektrik Ticaret ve Sanayi Ltd. Sti.
Okçumusa Cad. Kismet Han 94/2
TR-80020 Karaköy/Istanbul
Tel. +90 2122377982
Fax +90 2122354609



IAC & Associates
2180 Fasan Drive
Oldcastle
CDN-Ontario N0R 1L0
Tel. +1 519 7370311
Fax +1 519 7370314
TF +1 800 711 1900



Yuden-Tech Co., Ltd.
5F., No. 121, Lide St.,
Zhonghe City, Taipei County 235,
Taiwan (R.O.C.)
Tel. +886 2 8221 2958
Fax +886 2 8221 2492



Shanghai Beishidietian Business Trade Co., Ltd.
4F, No. 88-1, Lane 7039,
Zhongchun Rd., Minhang Area
Shanghai City
Tel. +86 21 54887307
Fax +86 21 54887305



CSE-W. Arthur Fischer Ltd.
15 Polaris Place, Greenmount
NZ-East Tamaki, Auckland
Tel. +64 9271 3810
Fax +64 9265 1362



Kolektor Synatec d.o.o.
Vojkova ul. 8b,
PO Box 57
SI-5280 Idrija
Tel. +386 5 3720650
Fax +386 5 3720660



Introl Sp. z o.o.
ul. Kościuszki 112
40-519 Katowice
Tel. +48 32 789 00 00
Fax +48 32 205 33 77



Bibus Portugal, LDA
Centro Empresarial AAA
Rua Ponte da Pedra, 240 - C4
4470-108 Gueifães - Maia
Porto
Tel. +351 229 065 050
Fax +351 229 065 053



Futron Electronics PTE Ltd.
1004 Toa Payoh North
#04-08/09/10
Singapore 318995
Tel. +65 6250 2456
Fax +65 6250 6592



Useong Electrade Co.,
D-1006, Technopark
No. 1345, Soha-dong, Gwangmyeong-si
Gyeonggi-do,
Korea
Tel. +82 (0) 2 2686 7314
Fax +82 (0) 2 2686 7316