

Linear Luminaire with LED

Series EXLUX 6002/1 Version IIB



www.stahl.de



- > For use in hazardous areas with gas group IIB
- > Latest LED technology with a high luminous efficacy and a long service life
- > As pendant light fitting or pole mounted light fitting
- > Central locking

E2



16707E00

The luminaires with LED Series **EXLUX 6002** are suitable for general lighting of indoor and outdoor areas. The luminaires with LED were designed for 1 to 1 replacing of luminaires with fluorescent lamps. An equivalent luminous flux by lower energy consumption ensures an increase in efficiency of the lighting system.

Zone	ATEX / IECEx					
	0	1	2	20	21	22
For use in		x	x		x	x

Explosion Protection	
Global (IECEx)	
Gas and dust	IECEx IBE 14.0035 Ex db eb op is IIB T4 Gb Ex tb op is IIIC T100°C Db
Europe (ATEX)	
Gas and dust	IBExU 14ATEX1088 ⊕ II 2 G Ex db eb op is IIB T4 Gb ⊕ II 2 D Ex tb op is IIIC T100°C Db
Certifications and certificates	
Certificates	IECEx, ATEX, India (PESO)

WebCode 6002B

Linear Luminaire with LED

Series EXLUX 6002/1 Version IIB

Selection Table

Version	Diffusor	Length mm	Power consumption	Cable entry	Order number	Weight kg
EXLUX 6002 Gasgruppe IIB	with	700	28 W	3x M25 Plastic	6002/1182-5400-5131-0	4.300
				3x M20 Metal	6002/1182-5400-5232-0	4.300
	with	1310	52 W	3x M25 Plastic	6002/1284-5400-5131-0	6.600
				3x M20 Metal	6002/1284-5400-5232-0	6.600

Note

The light fittings are delivered without mounting material.
These accessories must be ordered separately!

Technical Data

Electrical data

Ballast

AC: 110 V ... 240 V $\pm 10\%$; 50 ... 60 Hz
DC: 110 V ... 250 V $\pm 10\%$

	6002/1.2-....-....-0		6002/2.4-....-....-0	
Power consumption [W]	28		52	
Voltage [V]	230	110	230	110
Frequency [Hz]	50	60	50	60
Power factor	> 0.90	> 0.99	> 0.95	> 0.99
THD [%]	< 8	< 12	< 6	< 6

Inrush current

$I_{peak} = 51\text{ A}$; $\Delta t = 127\ \mu\text{s}$
maximum number of luminaires per miniature circuit breaker at 230 V:

Type	10 A	16 A	20 A	25 A
B	8	13	16	20
C	13	22	27	34
K	27	44	55	69

Luminous characteristics

	6002/1.2-....-....-0	6002/2.4-....-....-0
Power consumption [W]	28	52
Colour rendering [CRI]	≥ 80	≥ 80
Colour temperature [K]	5,000	5,000
without diffuser		
Luminous flux [lm]	3,000	6,000
Luminaire efficiency [lm/W]	107	115
with diffuser		
Luminous flux [lm]	2,400	4,650
Luminaire efficiency [lm/W]	86	89

Values apply to $T_a = +25\text{ }^\circ\text{C}$.
Luminous flux decrease
• at $T_a = +60\text{ }^\circ\text{C}$ to $\geq 70\%$ of the nominal value.
• during DC operation to 50%.

Ambient conditions

Operating temperature range

-30 ... +60 °C luminaires without through wiring
-30 ... +60 °C luminaires with through wiring; $I_N \leq 10\text{ A}$
-30 ... +50 °C luminaires with through wiring; $I_N \leq 16\text{ A}$

Storage

-30 ... +75 °C

Linear Luminaire with LED

Series EXLUX 6002/1 Version IIB



Technical Data

Service life

Service life	$T_a \leq 25\text{ °C}$	$T_a \leq 45\text{ °C}$	$T_a \leq 60\text{ °C}$
L ₇₀ B ₁₀ C ₁₀	100,000 h	90,000 h	50,000 h

L_xB_yC_z
 At the end of the service life:

- Luminous flux decrease to "x" percent
- up to "y" percent of all luminaires fall below "x"
- up to "z" percent of all luminaires break down completely

E2

Mechanical data

Degree of protection	IP66 / IP67 (IEC 60598)
Protection class	I (with internal PE connection)
Impact strength (IK code)	IK10 (IEC 62262)
Material	
Enclosure	
Material	Polyester resin, glass fibre-reinforced
Colour	colour grey, similar to RAL 7035
Seal	Silicone foam gasket in the lamp cover
Translucent cover	Polycarbonate
Luminaire locking	Central locking which can be opened/closed using a socket key M8 / wrench size 13, hinged lamp cover

Mounting / Installation

Cable glands	<p>Standard luminaire</p> <p>Plastic: 2 x M25 x 1.5 cable glands 8161 and 2 x M25 x 1.5 stopping plugs 8290 (enclosed)</p> <p>Metal: 2 x metal plates M20 x 1.5 connected by means of PE for metal cable entries Attention: cable entries must be ordered separately</p> <p>Special: max. 4 bores for M20, M25, NPSM ½" max. 2 bores for NPT ¾"</p> <p>Metal cable glands: M20 x 1.5, M25 x 1.5; earthing of the metal cable entries by means of metal plates</p>
Connection	<p>Standard: Spring clamp terminals 5-pole: L1, L2, L3, N, PE Clamping range: 1 x 0.75 ... 4 mm² (solid / finely stranded) (2 free clamping units per pole available)</p> <p>Special: Terminal block with covering 5-pole: L1, L2, L3, N, PE Clamping range: 2 x 0.75 ... 6 mm² (solid); 2 x 0.75 ... 4 mm² (finely and extra finely stranded)</p>
Through wiring	<p>Standard luminaire with Light fittings are equipped with internal through wiring. Ingoing and outgoing leads can be connected to the opposite sides. Terminals: see techn. data Wiring cross section: 2.5 mm² for max. 16 A.</p> <p>Optional without On the connection side, there are 2 bores M25 x 1.5 for cable entries for ingoing and outgoing wiring of the connection line (ingoing and outgoing leads on one side).</p>
Assembly	<p>Standard luminaire</p> <p>Standard: 2 x M8 insert nuts in the enclosure</p> <p>Special: Mounting grooves in the enclosure for the use of fastening and ceiling rails for variable luminaire mounting (variable mounting distances for luminaires L = 700 mm: 320 ... 480 mm; L = 1310 mm: 670 ... 930 mm)</p>

Linear Luminaire with LED

Series EXLUX 6002/1 Version IIB

Light Distribution Curves

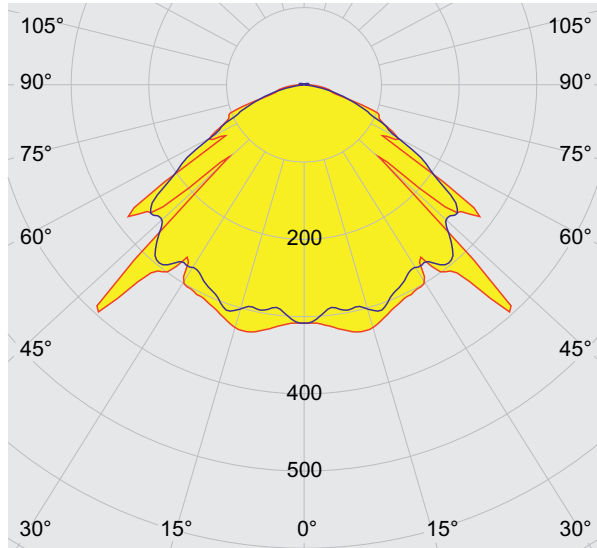

cd/klm 100%
 — C0 - C180 — C90 - C270

16683E00

28 W without diffusor

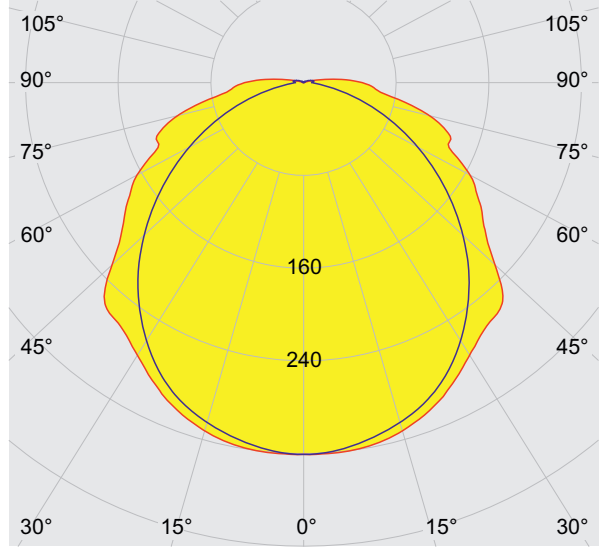

cd/klm 100%
 — C0 - C180 — C90 - C270

16723E00

28 W with diffusor

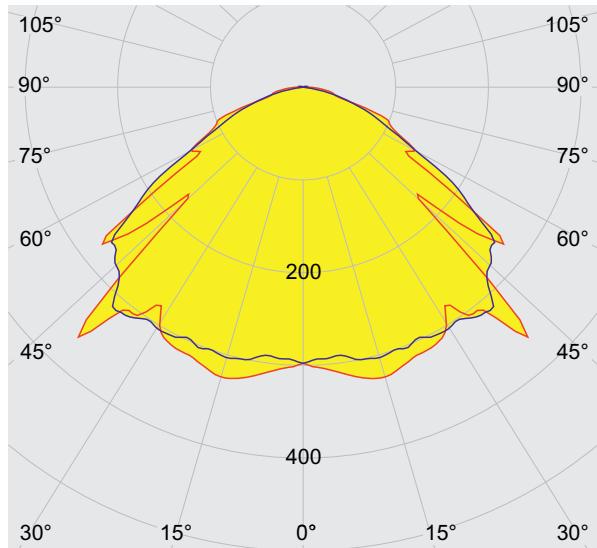

cd/klm 100%
 — C0 - C180 — C90 - C270

16724E00

52 W without diffusor

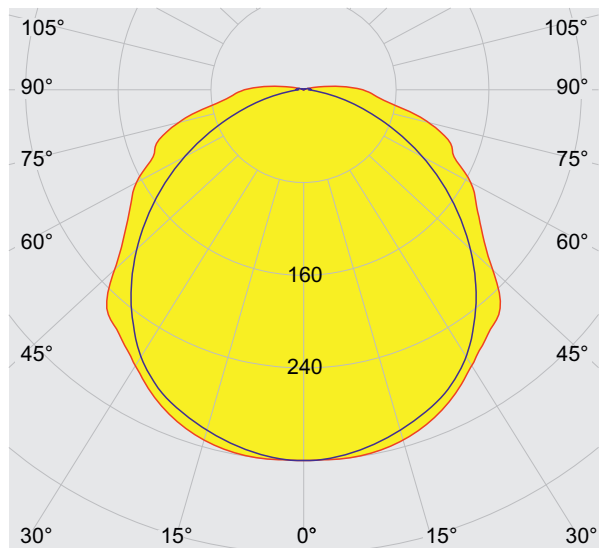

cd/klm 100%
 — C0 - C180 — C90 - C270

16725E00





52 W with diffusor

Linear Luminaire with LED

Series EXLUX 6002/1 Version IIB

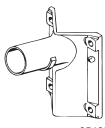
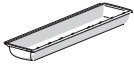
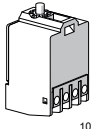
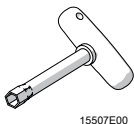
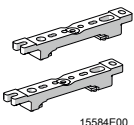
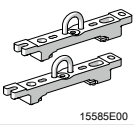

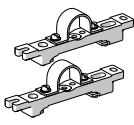
Accessories and Spare Parts

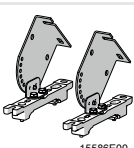
Designation	Figure	Description	Art. no.	Weight kg
Bracket for wall mounting with tube	 05460E00	for side entry lamp; with tube, length 400 mm, \varnothing 42 mm	108947	2.480
Translucent cover		for luminaire L=700	222427	0.639
		for luminaire L=1310	222428	1.149
Switch	 10809E00	Switching element 8080/1-3-L, 2 normally closed contacts	132527	0.026
Socket key	 15507E00	M8 / wrench size 13; to open/close the central locking	222430	0.210
Mounting rail	 15584E00	for a variable mounting distance	1 pair 222826	0.300
Mounting bracket	 15585E00	mounting clamp mounted on a mounting rail for a variable mounting distance	1 pair 222456	0.400
Pole mounting sleeve	 16985E00	for the subsequent mounting on lights 18 W and 36 W, completely with assembly parts	227512	3.200
Pipe clamp	 15583E00	R 1 1/2"	222459	1.200
		R 1 1/4"	222458	1.250
		R 2"	222460	1.300
		with mounting rail for a variable mounting distance; Material: stainless steel	1 pair	
Ring bolt	 05378E00	M8, direct mounting in insert nuts, 1 pair	115736	0.112
Ceiling and wall-mounting bracket	 15586E00	mounted on a mounting rail for a variable mounting distance; Material: stainless steel Lamp can be swiveled in steps of 15°	1 pair 222827	1.200

E2

Linear Luminaire with LED

Series EXLUX 6002/1 Version IIB

Dimensional Drawings (All Dimensions in mm [inches]) - Subject to Alterations

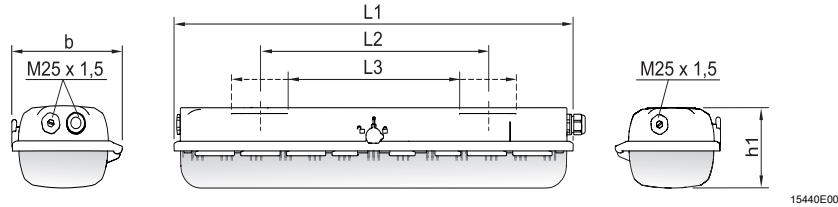

Dimensions	Luminaire	
	28 W	52 W
L1	700 [27.56]	1310 [51.57]
L2 ¹⁾	400 [15.75]	800 [31.50]
L3 ²⁾	320 ... 480 [12.60 ... 18.90]	670 ... 930 [26.38 ... 36.61]
b	184 [7.24]	184 [7.24]
h1	125 [4.92]	125 [4.92]

¹⁾ fixed mounting distance ²⁾ variable mounting distance

EXLUX 6002 Standard luminaire

Dimensional Drawings for Assembly Parts and Accessories (All Dimensions in mm [inches]) - Subject to Alterations

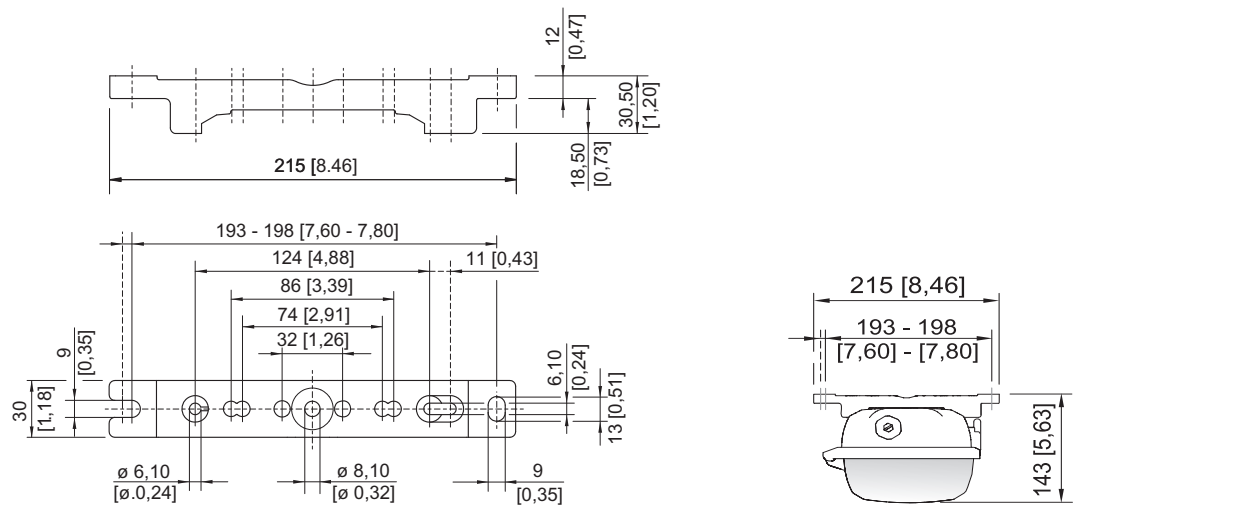

Mounting rail

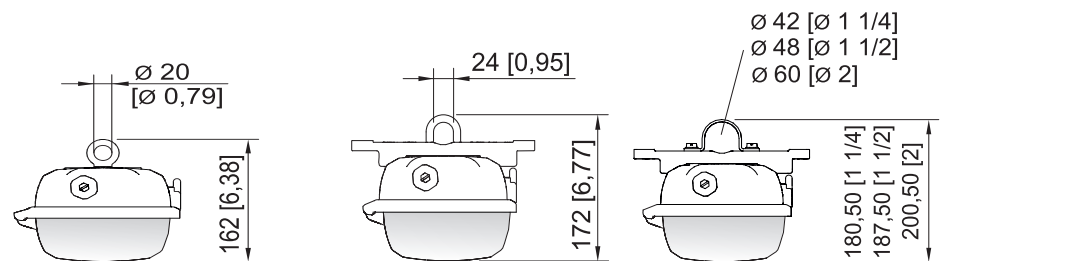

Ring bolt fitted in insert nut of the luminaire

Mounting bracket fitted in mounting rail

Pipe clamp fitted in mounting rail

Linear Luminaire with LED

Series EXLUX 6002/1 Version IIB



Dimensional Drawings for Assembly Parts and Accessories (All Dimensions in mm [inches]) - Subject to Alterations

E2

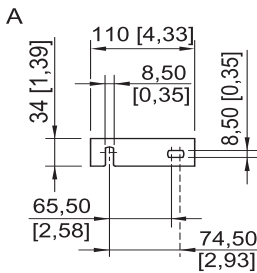
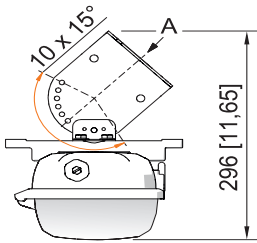

15780E00

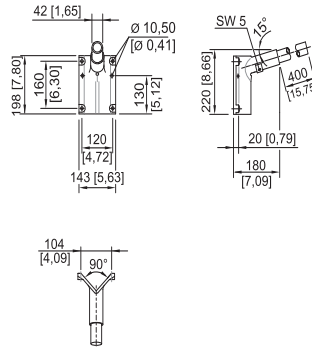

03257E00

Wall mounting bracket fitted in mounting rail

Bracket for wall mounting with pipe section

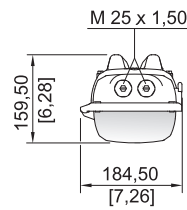
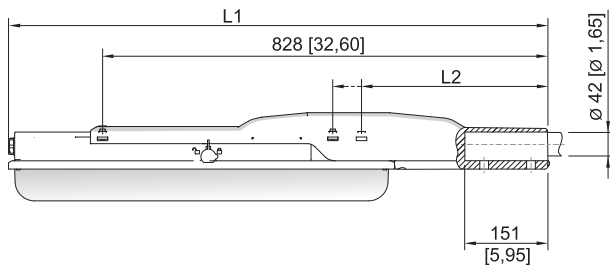

17755E00

Dimension	Light	
	700 mm	1300 mm
L1	978 [38.50]	1587 [62.48]
L2	390 [15.35]	338 [13.31]

Linear Luminaire EXLUX with pole mounting sleeve

We reserve the right to make alterations to the technical data, dimensions, weights, designs and products available without notice. The illustrations cannot be considered binding.