

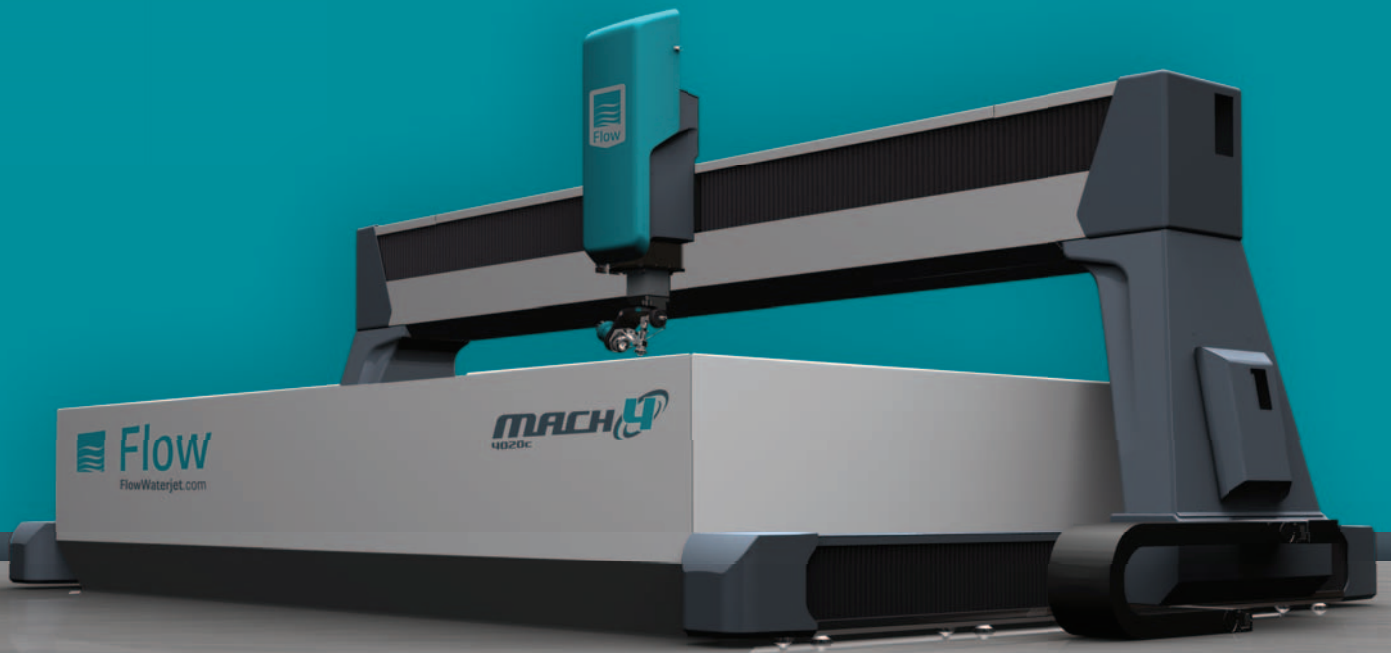

# Flow

MACH 4 WATERJET SERIES



**MACH 4**

YEARS AHEAD.

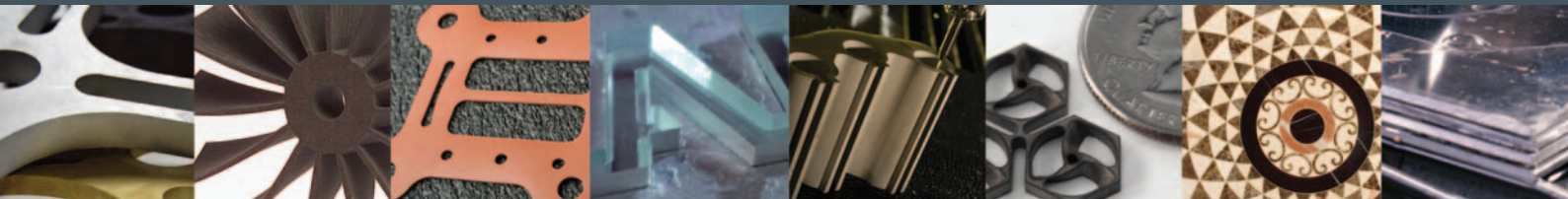



# INVEST IN YOUR FUTURE

Wrapped in a sleek design, every feature on the Mach 4 is purposefully constructed to make you more productive.

## CUTTING HEAD TECHNOLOGY



### PURE WATERJET

Hair-thin pure waterjet stream cuts soft materials.



### STANDARD WATERJET

Uses garnet abrasive to cut virtually any hard material.



### DYNAMIC WATERJET®

Three times faster and more accurate than Standard Waterjet.

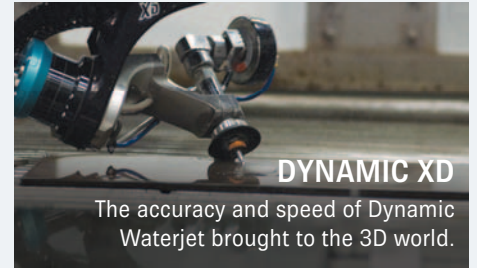

### DYNAMIC XD

The accuracy and speed of Dynamic Waterjet brought to the 3D world.

## A PUMP FOR EVERY APPLICATION

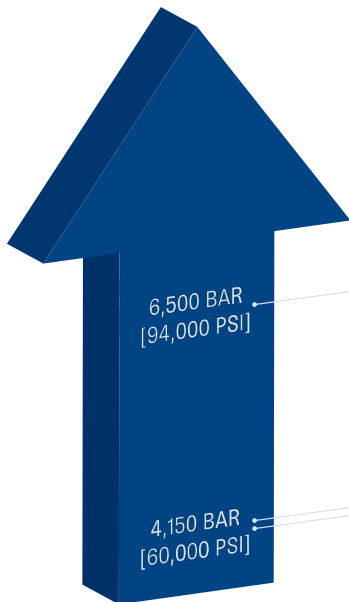

### PRESSURE = PRODUCTIVITY

Flow offers the widest array of high-pressure pumps. Each is fully integrated with sensor driven diagnostics that are monitored by the Mach 4 operator station.



### HYPERJET®

6,500 BAR [94,000 PSI]

With pressures rated at an industry leading 6,500 bar [94,000 psi] and continuous operating pressures of 6,000 bar [87,000 psi], HyperJet pumps provide maximum productivity.

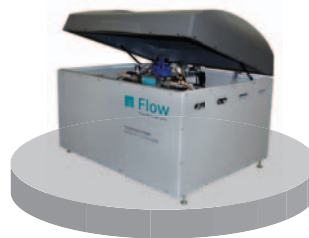

### INTENSIFIER

4,150 BAR [60,000 PSI]

With continuous operating pressure at 4,150 bar [60,000 psi], this is the longest lasting, lowest maintenance ultrahigh-pressure pump in the industry.



### HYPLEX® PRIME

4,150 BAR [60,000 PSI]

With pressures rated at 4,150 bar [60,000 psi] and continuous operating pressures of 3,800 bar [55,000 psi], HyPlex Prime pumps are the highest pressure, most advanced direct drive pumps available today.



**FASTER CUTTING. FASTER REWARDS.**

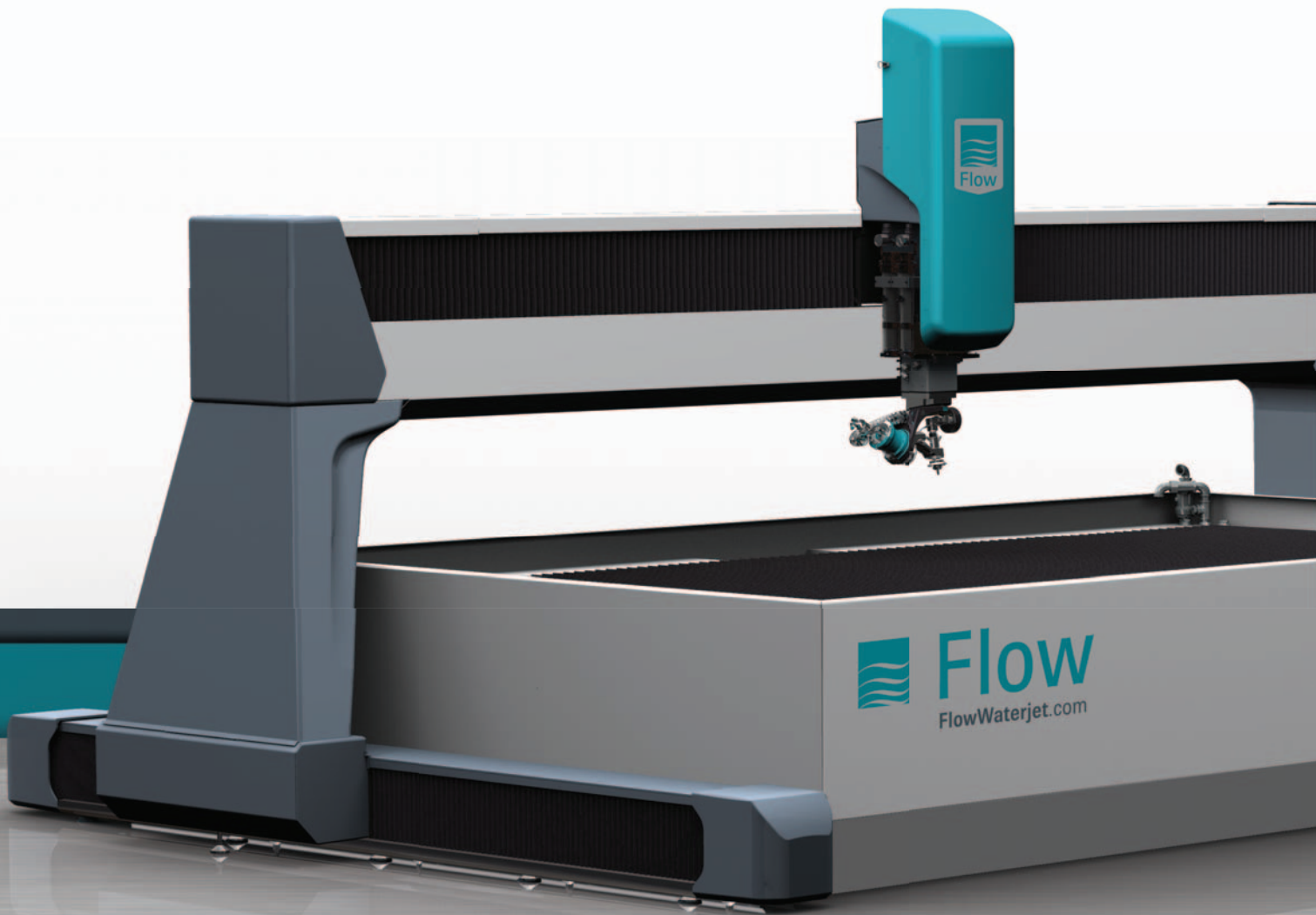

## THE NEXT GENERATION OF WATERJET

### ENGINEERED TOUGH



With durable design throughout, the Mach 4 is made up of precision machined and thermally stress-relieved solid steel castings, easily handling even the most rigorous use day in and day out.

### MODULAR DESIGN

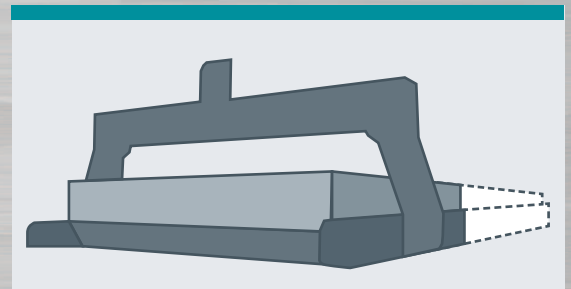

Unlike any other system available, this easily expandable modular design allows your waterjet system to grow with your business. Add increased capabilities and cutting area as needed.



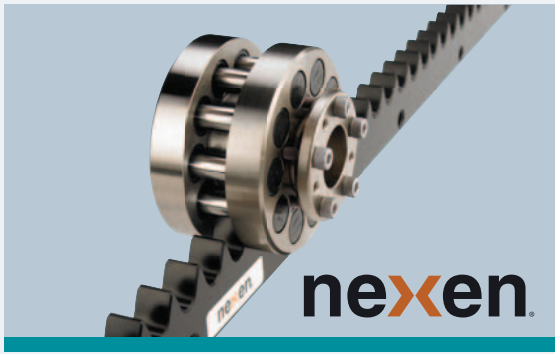

THE BEST RIDE

CLOSE FLAP FOR THE BEST RIDE



**MACH 4 4020c**  
*\*See additional sizes and specifications on back*

**SIMPLE YET POWERFUL SOFTWARE**



Our comprehensive software suite allows you to draw, design, import and program flat stock and 3D parts with ease and efficiency.

**PRESSURE = PRODUCTIVITY**

The physics are simple and the results are conclusive: the faster your waterjet stream moves, the faster you can cut. A faster waterjet stream also uses less abrasive.

**Cut Faster. Lower Costs. Increase Production.**

Whether you are prototyping one-off parts or producing large quantities of parts, higher pressure will get your job done significantly faster and at an overall lower cost.

**POWER DENSITY »**  
HP/2.54 CM<sup>2</sup> (HP/SQ IN)

**JET DIAMETER »**

**JET TAPER »**

**ABRASIVE RATE »**  
HG/MIN (LBS/MIN)

**SMARTSTREAM™ TECHNOLOGY**

Our exclusive SmartStream technology uses patented complex mathematical models that automatically adjust your cutting stream based on the material parameters you choose.

Simply select your material type and thickness from the library of over 100 tested and pre-programmed materials. SmartStream will calculate the correct speed and angles to provide you with a precise part at the fastest speed possible.

**DYNAMIC WATERJET®—DYNAMICALLY SUPERIOR PARTS**

Our patented Dynamic Waterjet works unlike any other system. Using our SmartStream technology, Dynamic Waterjet not only counters stream lag and taper (characteristics inherent to waterjet), but also automatically tilts and monitors the speed of your cutting head on the fly. This ensures the part you pick up off the table is cut as quickly as possible, and to high precision.

- Exacting precision: +/- .0254 mm [+/- .001 in]
- Up to 3x faster than standard systems

**DYNAMIC WATERJET® XD—DYNAMICALLY SUPERIOR PARTS**

Dynamic XD incorporates the unique capabilities of SmartStream technology and Dynamic Waterjet (described above) for angular cutting. This distinctive Flow technology can cut with 5-axis motion, even cutting compound angles with improved speed and accuracy. Easily cut flat stock with up to +/- 60° of motion.

*Test cut for safety required on all formed and 3D parts.*

**2,750 BAR**  
[40,000 PSI]

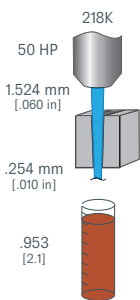

**4,150 BAR**  
[60,000 PSI]

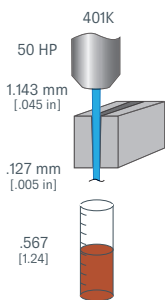

**6,200 BAR**  
[90,000 PSI]

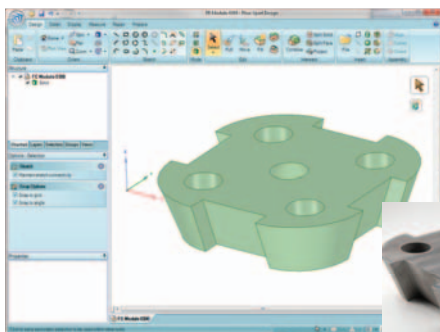
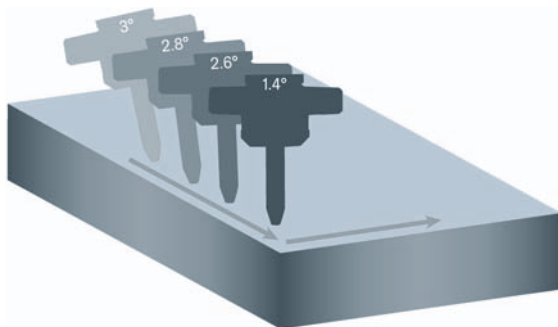
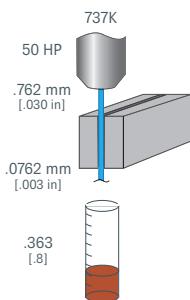

## THE BEST RIDE

Waterjet performance and cut part quality depend heavily on the motion system. The Mach 4 features a state-of-the-art drive system, the Nexen Roller Pinion System (RPS). Offered **exclusively** by Flow, this special motion system combines the best features of linear motors, precision ball screws and pinion systems without the compromises.

**Achieve speed and accuracy with zero backlash.**

## FASTER, MORE ACCURATE CUTTING



Groundbreaking cutting and motion technology provides high speed cutting and unrivaled precision, ensuring you are well equipped for even the toughest job in your shop.

# OPERATOR CONVENIENCE

## EFFICIENCY THROUGH DETAILS

We work hard to provide operator convenience features that allow you to cut faster, more accurate parts. The Mach 4 takes productivity and ergonomics to the next level, making you more efficient through design.

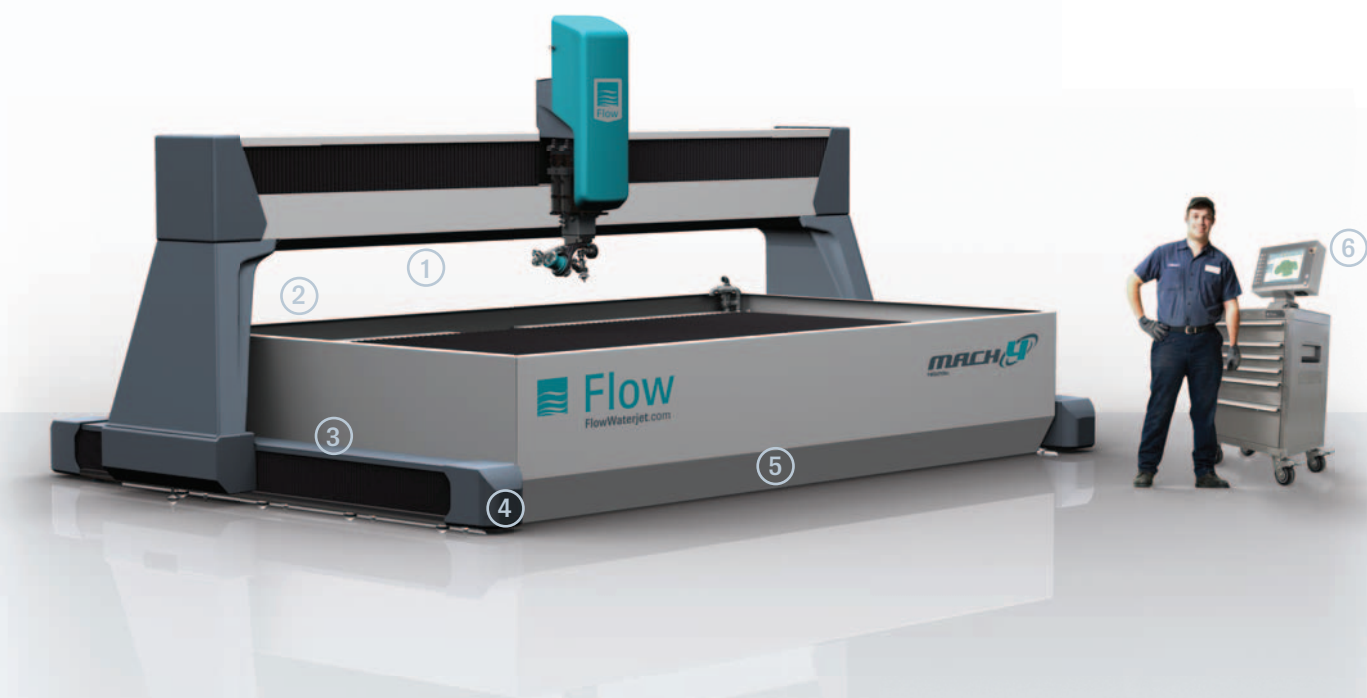

### 1. ENHANCED WORKPIECE VISIBILITY

Exclusive under-bridge LED lighting provides increased visibility, helping to improve part accuracy and reduce operator fatigue.



### 2. HYDROCLEAN™ ABRASIVE REMOVAL

Specialty jets efficiently flush waterjet abrasive, removing it automatically, so you don't have to do it manually. This revolutionary system provides easy removal for less downtime and increased production.



### 3. ACCESSIBILITY STEP

The machine design provides optimal system stability. It can also be used as an integrated operator step, for additional access to your workpiece as needed.



### 4. HANDY AIR & WATER CONNECTIONS

Easily access air and water, both on the same hand-held connection.



### 5. ERGONOMIC TOE-KICK

Designed with the operator in mind, the unique toe-kick allows for comfortable access to your materials and parts.

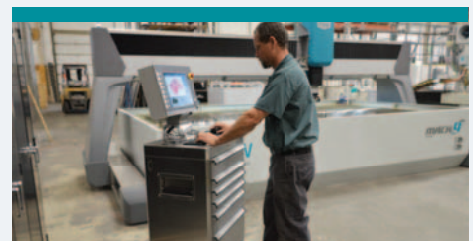

### 6. ROLL-AROUND CONTROL

Move freely about your waterjet, taking your touch screen control console with you for convenience.

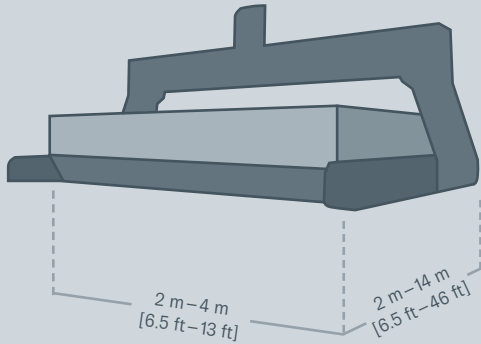

<b>Mach 4 Specifications</b>		
<b>Linear Straightness Accuracy</b>	.025 mm/m	.001 in/3 ft
<b>Repeatability</b>	.025 mm	.001 in
<b>Maximum Speed</b>	36 m/min	1,400 ipm
<b>Z Travel</b>	305 mm	12 in
<b>Bridge (x-axis)</b>	2 m, 3 m, 4 m	6.5 ft, 10 ft, 13 ft
<b>Base (y-axis)</b>	2 m - 14 m (1 m increments)	6.5 ft - 46 ft

## ADDITIONAL OPTIONS & ACCESSORIES

- Catcher Tanks in Stainless Steel or Mild Steel
- Water Level Control
- Multiple Cutting Heads
- HydroClean Abrasive Removal System
- UltraPierce Material Piercing Assist
- High-Pressure Pump Option up to 6,500 bar [94,000 psi]
- Laser Edge Finder
- And More



Headquarters for Europe,  
Middle East and Africa:

### FLOW EUROPE GMBH

Gewerbestraße 95  
75015 Bretten, Germany  
Tel. +49 (0)72 52 53 80  
info@flowgmbh.com

### FLOW EASTERN EUROPE S.R.O.

Holandská 4 • Spielberk Office Centre  
639 00 Brno, Czech Republic  
Tel. +420 511 120 400  
info@flowcorp.cz

### FLOW FRANCE SARL

38, Place des Pavillons  
69007 Lyon, France  
Tel. +33 (0)4 72 80 82 03  
flowfrance@flowfrance.com

### FLOW IBÉRICA, S.L.

Pol. "Európolis" - c/Dublin • Nave 5B  
28232 Las Rozas (Madrid), Spain  
Tel. +34 91 6 40 73 93  
flow.dmv@flowiberica.com

### FLOW ITALIA S.R.L.

Strada per Turbigo, 64  
20010 Arluno (MI), Italy  
Tel. +39 02 90 37 93 83  
info@flowitalia.com

### FLOW MIDDLE EAST & AFRICA

4WA 127, Dubai Airport Freezone  
Dubai, U. A. E.  
Tel. +971 4 260 28 69  
info-middleeast@flowcorp.com

### FLOW UK LTD.

19 Wheatfield Way  
Hinckley LE10 1YG, UK  
Tel. +44 (0)14 55 89 53 00  
info@flowuk.com

[FlowWaterjet.com](http://FlowWaterjet.com)

