

2025

PRODUKTKATALOG

PRODUCT CATALOG / PRODUKT KATALOG

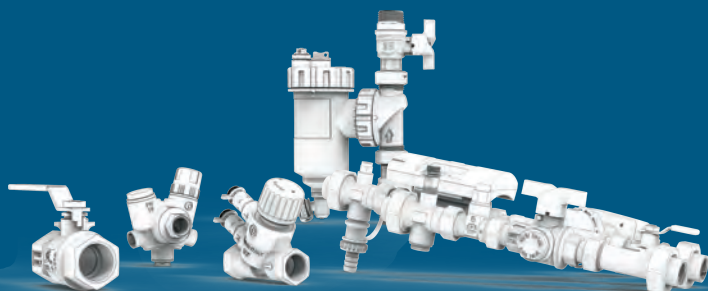

VAND / WATER / WASSER



GAS / GAS / GAS



GULVVARME / MANIFOLDS / VERTEILER



VARME / HEATING / HEIZUNG



HVAC





CERTIFICERINGER • CERTIFICATIONS • ZERTIFIZIERUNGEN



FM01402



ENMS582052



EMS72948



Læs mere på www.pettinaroli.dk om koncernens certificeringer og holdning til bæredygtighed og de 17 verdensmål.

Read more at www.pettinaroli.dk about the group's certifications and attitude towards sustainability and the 17 world goals.

Lesen Sie auf www.pettinaroli.dk mehr über die Zertifizierungen und die Einstellung der Gruppe zur Nachhaltigkeit und die 17 Weltziele



PETTINAROLI A/S, DENMARK

 PETTINAROLI A/S er leverandør af kvalitetskomponenter og komplette systemløsninger til den danske VVS-branche og har derudover samhandel med en lang række europæiske virksomheder. Virksomheden har været på banen siden 1976, under navnet Jørgen Pedersen VVS.

I år 2000 skiftede virksomheden navn til Pettinaroli A/S og blev en del af den italienske koncern Fratelli Pettinaroli SpA, hvor produktion og produktudvikling af varmpressede messingprodukter foregår - og det har det gjort siden 1938.

Pettinaroli A/S er beliggende i Middelfart og fra hovedlageret distribueres det store sortiment til alle danske VVS-grossister samt til 17 lande i Nord-, Mellem- og Østeuropa.

SERVICE, KVALITET og FLEKSIBILITET er vigtige nøgleord i vores hverdag og vore kompetente medarbejdere står altid klar med en hjælpende hånd uanset forespørgsels karakter.

 PETTINAROLI A/S is a supplier of high quality components and complete system solutions to the Danish plumbing industry and a large number of European customers. The company has been around since 1976, where it was founded under the name of Jørgen Pedersen VVS.

In 2000 the company changed its name to Pettinaroli A/S and became part of the Italian group Fratelli Pettinaroli SpA. The production and product development of hot forged brass products takes place in Italy.

Pettinaroli A/S is located in Middelfart and from here Pettinaroli distributes the large range of products for all Danish plumbing wholesalers and to 17 countries in North, Central and Eastern Europe.

QUALITY, SERVICE AND FLEXIBILITY is important keywords in our everyday lives and our experienced staff is always ready to help with any questions

 PETTINAROLI A/S ist Lieferant für Qualitätskomponenten und komplette Systemlösungen für die dänische Sanitärbranche. Weiterhin werden unsere Partner in Skandinavien, in Ost- und Zentraleuropa täglich vom Lager- und Logistikzentrum in Middelfart, Dänemark, beliefert. Das Unternehmen wurde 1976 unter dem Namen Jørgen Pedersen VVS gegründet, und dient somit seit über 30 Jahren als Verkaufs- und Logistikzentrum für 17 Länder europaweit.

Im Jahre 2000 wurde die dänische Gesellschaft, Jørgen Pedersen VVS, ins italienische Unternehmen Fratelli Pettinaroli SpA, aufgenommen und der Name somit auf Pettinaroli A/S geändert. Die gesamte Produktentwicklung und Herstellung der wärmegepressten Messingkomponenten findet in Italien statt und das seit 1938

QUALITÄT, SERVICE UND FLEXIBILITÄT sind Schlüsselparameter im täglichen Betrieb. Unsere kompetenten Mitarbeiter stehen Ihnen jederzeit zur Verfügung. Schicken Sie uns Ihre Anfrage per Fax oder Email zu oder rufen Sie uns einfach direkt an. Per UPS erreichen wir unsere Kunden fast überall in Deutschland innerhalb von 1 bis 2 Tagen (Kleinpakete), in Österreich innerhalb von 3-4 Tagen. Etwa 1.200 einzelne Pettinaroli Waren liegen versandbereit auf Lager in Middelfart.

GODKENDELSER • APPROVALS • ZULASSUNGEN



**GODKENDT
TIL DRILLEVAND**

Find alle godkendelser på de enkelte produkter på www.pettinaroli.dk.

Find all approvals for the individual products at www.pettinaroli.dk.

Alle Zulassungen der Produkte finden Sie unter www.pettinaroli.dk.

PETTINAROLI SPA

● Montage

■ ■ ■ **Fratelli Pettinaroli** er garantien for kvalitet og innovation - **100% Made in Italy**. Fabrikken ligger i San Maurizio d'Opaglio, hvor fabrikkerne optager et areal på 75.000 m2 nedsænket i naturen. **Miljøet** har altid været et tema, som familien Pettinaroli give den største respekt. Fabrikken er udstyret med **solceller**, som producerer 50% af el forbrugt. Derudover dækker solpaneler, fra **EvoSolar**-serien 80% af behovet for varmt brugsvand. **Pettinarolis filosofi** er orienteret mod kvalitet, forskning og udvikling, opmærksomhed på energibespa-

relse og øko-kompatibilitet af produkter. For at nå disse mål koncentrerer virksomheden indsatsen maksimalt på kvalitetstest, ledelseskontrol, innovation af produkter og processer, uddannelse, kompetence og engagement af menneskelige ressourcer. Produktionssystemet og Pettinarolis produkter er naturligvis certificeret efter internationale standarder. Med over **85 års historie** og en solid fremtid i horisonten, er Fratelli Pettinaroli nu synonymt med pålidelighed i over 60 lande rundt om i verden.

🇬🇧 **Fratelli Pettinaroli** is the guarantee of quality and innovation - **100% Made in Italy**. The factory is located in San Maurizio d'Opaglio, where the factories occupy an area of 75,000 m2 immersed in nature. **The environment** has always been a theme that the Pettinaroli family give the utmost respect. The factory is equipped with **solar cells**, which produce 50% of electricity consumption. In addition, solar panels from the **EvoSolar** series cover 80% of the need for domestic hot water. **Pettinaroli's philosophy** is oriented towards quality, research and development, attention to

energy saving and eco-compatibility of products. To achieve these goals, the company concentrates its efforts maximally on quality testing, management control, innovation of products and processes, training, competence and commitment of human resources. The production system and Pettinaroli products are of course certified according to international standards. With over **85 years of history** and a solid future on the horizon, Fratelli Pettinaroli is now synonymous with reliability in over 60 countries around the world.

🇩🇪 **Fratelli Pettinaroli ist der Garant für Qualität und Innovation - 100% Made in Italy**. Die Fabrik befindet sich in San Maurizio d'Opaglio, wo die Fabriken eine Fläche von 75.000 m2 inmitten der Natur einnehmen. **Die Umwelt** war schon immer ein Thema, dem die Familie Pettinaroli größten Respekt entgegenbringt. Die Fabrik ist mit **Solarzellen** ausgestattet, die 50 % des Stromverbrauchs erzeugen. Darüber hinaus decken Sonnenkollektoren der **EvoSolar**-Serie 80 % des Warmwasserbedarfs. **Die Philosophie** von Pettinaroli ist auf Qualität, Forschung und Entwicklung, Aufmerksamkeit auf

*Energieeinsparung und Umweltverträglichkeit der Produkte ausgerichtet. Um diese Ziele zu erreichen, konzentriert das Unternehmen seine Anstrengungen maximal auf Qualitätsprüfung, Managementkontrolle, Innovation von Produkten und Prozessen, Ausbildung, Kompetenz und Engagement der Humanressourcen. Das Produktionssystem und die Pettinaroli-Produkte sind selbstverständlich nach internationalen Standards zertifiziert. Mit über **85 Jahren Geschichte** und einer soliden Zukunft am Horizont steht Fratelli Pettinaroli heute in über 60 Ländern der Welt für Zuverlässigkeit.*

● Lager

Pettinaroli - the Group

Pettinaroli UK
Marflow Hydraulics
Birmingham - UK

Pettinaroli Denmark
Middelfart - DEN



ERHVERVSSEKTORER / BUSINESS SECTORS / GESCHÄFTSSEKTOREN

HVAC

VARME

VAND

GAS



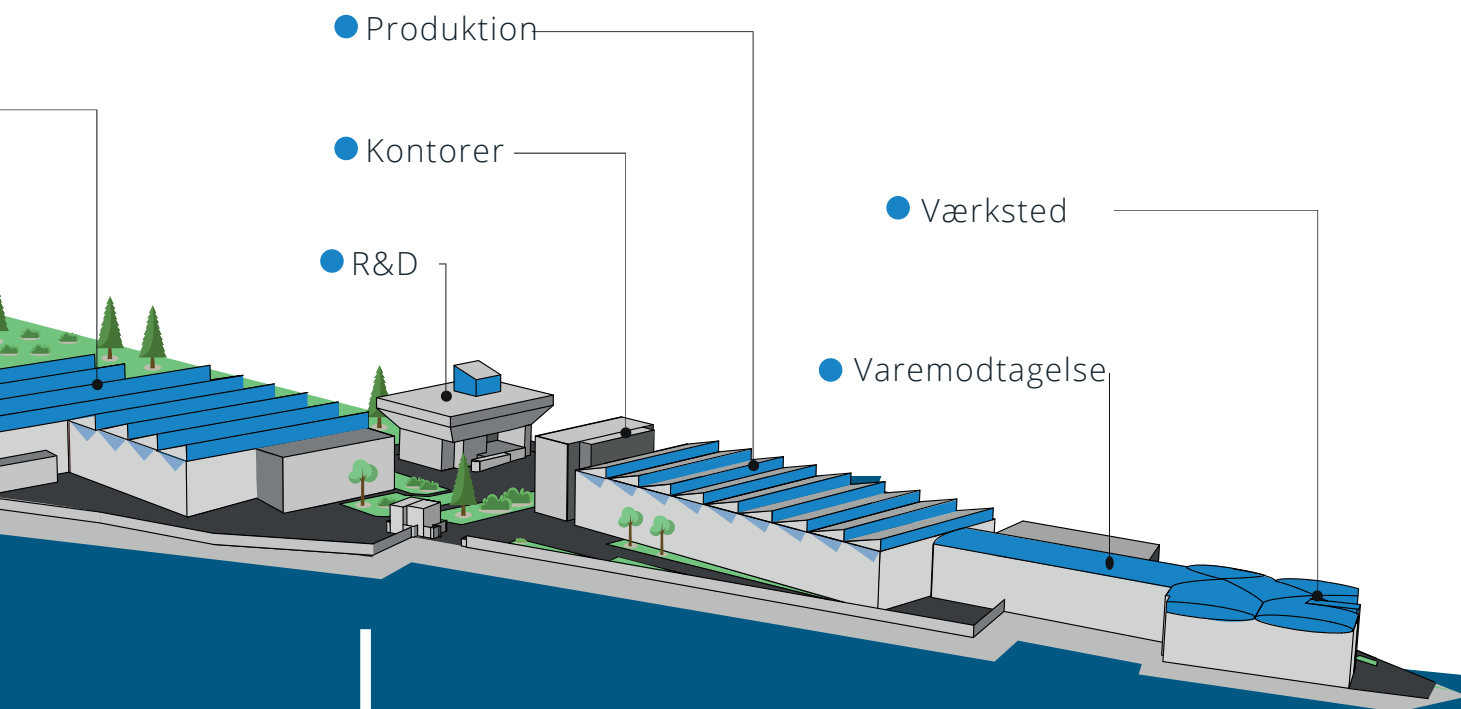

+
20.000.000

**Færdige
produkter**

+
90.000.000

**Komponenter
håndteret**

+
7.000

**Paller
afsendt**

+
150

**Containere
afsendt**

Product	Page	Product	Page	Product	Page	Product	Page	Product	Page	Product	Page
0100AJ	17	109L	37	52CES	7	760DPR	38	DE-017	42	KK850	39
0148	15	109LCRO	37	52CEST	7	760ME	27	DE-018	42	KK850B	39
0148SC	15	148SA	15	52EUR	3	760P	38	DE-019	42	MGVU	35
035/1	28	148SC	15	52EUR/1	3	761DPR	38	DE-023	43	ODR4070H	23
035/2	28	149SC	15	52EUR/2	3	761P	38	DE-026	42	P100	4
035/2TEA-006	34	168/O	13	52MET	8	763H	38	DE-043	42	P100/0	4
035M	29	170	13	52MET/1	8	800P	38	DE-044	42	P100/1	4
035MP/1	29	175GLO	14	52METR	8	800PPR	38	DE-069	42	P100L	4
035P/1	29	184GO	13	52METR/1	8	919	32	DE-071	43	P102	5
036/1	29	184M0	13	52METV	8	927	39	DE-072	43	P102/0	5
036/1TEA	34	188	14	52METV/1	8	92H	44	DE-088	43	P102/4	5
036MP/1	29	188CRM	14	52TEU	3	92L	44	DE-VFB	43	P102/4R	5
036P/1	29	188NDA	14	52TEU/1	3	92VL	44	EC-20001	19	P102T	5
051	16	188TEA	14	52TEUS	7	92XH/2	44	EC-20002	19	PPS	20
051BQC	16	209	9	53EU	3	92XL/2	44	EC-32010-06	22	PPSMP	20
051F	16	209/1	9	56F/2	11	92XVL/2	44	EC-32010-10	22	PS	20
051TEA	16	209B	9	58EU	4	A204	19	EC-32090	22	PSMP	20
052	16	209B/1	9	59	10	A220102-01K	21	EC-32090-K	21	R4070	23
052B	16	240NL	9	59/1	10	A220102-01KA	21	EC-32090-KA	21	R701DIN	41
052TEU	17	240NT	9	59/2	10	A220102-01KADPR	21	EC-32090-KD	21	SK20UPM-1	21
052V	16	248SC	15	59/9	10	A264202	23	EC-32090D	22	SKS	20
053	16	296N	9	696/97	15	A264202D	23	EC-34010-06	22	SKS7025	20
054H	17	3015	28	696/97	32	A404	22	EC-34010-10	22	T40	32
056	17	3015SCR	28	696TM	15	AC7014	31	EC-34090	22	TB20	7
058P	17	3015TEA-006	33	697	15	AC7014L	31	EC-34090D	22	TB30	7
07021B	27	3522M	30	700	41	AC7014T	31	EC-40090	23	TB50	7
070M	30	3523	30	7000PM	26	AC7035	31	EC-50001	19	VA02	19
070TM	30	35T	32	700DIN	41	AC7035T	31	EC-52010-XX	19	VA26	19
073	27	3625	28	701	41	ACC7021	31	EC-52080WD	19	VA32	19
073RAU	27	3625D	39	701C	40	APR40405	32	EC-52090WD	19	VA50	19
073RP	27	4040	30	701CG	40	BE-BASIC	36	ET-405	9	VA64	19
073S	27	4523M	30	701CKN	40	BE-BASICPTM	35	FM0XX	11	VA72	19
074	27	488NDA	14	701CN	40	BI-202	34	G051	18	VA72	19
075	27	502	15	701CRWB	40	BI-202PT	33	G052	18	VA78	19
076	27	510E	6	701CWB	40	BI-203	34	G51	18	VA80	19
0760P	32	510E/1	6	701DIN	41	BI-203PT	33	G51/1	18	XT702	44
077	27	510E/2	6	701WM	41	BI-204	34	G52	18	XT704	44
078	27	510RFV	10	7021	25	BI-204PT	33	IS500	33	XT880	44
079	27	510CS	7	7021SS	26	BI-219	34	IS51	2	XT881	44
0991B	32	510EU	2	7025	24	BI-219PT	33	IS7025	24		
1008N	17	510EU/1	2	7025SYS20	24	BI-220	34	IS7025M	24		
1016N	13	510EU/2	2	7035DM-008	26	BI-220PT	33	IS7025S	24		
1019	14	510EU/3	2	7035M-006	24	BI-227PT	34	IS7035	25		
103	12	510EUM	4	7035SYS20	25	BI-231	34	IS7037	25		
1031	17	51F	11	7035TDM	25	BI-231PT	34	IS7037UDV-3	25		
1032	17	51FG	11	7035TEM-006	24	BI-50XAT	33	IS7037UDV-7	25		
0168B	13	51G	10	7035TEM-008	26	BI-50XXT	33	JV-001	21		
106CN	37	51L	2	7035TOP20	26	BI-7081	33	JV-002D	21		
107CP	39	51NDAV	10	7080/1	31	C80	31	JV-002F	21		
107L	37	520E	6	714COM	7	DE-001	42	K103/2	12		
107LHN	37	520E/1	6	750N	38	DE-002	42	K7025	24		
107LKI	37	520E/2	6	750R	38	DE-003	42	K7035N	25		
107LKIS	37	520E/3	6	751N	38	DE-015	42	K7037N	25		
107LKIT	37	520E/3	32	751R	38	DE-016	42	K927	39		

WS-no.	Page	WS-no.	Page	WS-no.	Page	WS-no.	Page	WS-no.	Page
04 4407 1XX	39	04 6896 50X	33	40 3599 210	22	41 8188 8XX	8	48 0627 0XX	32
04 6746 1XX	28	04 6898 1XX	31	40 3599 606	22	41 8191 7XX	18	48 4900 00X	40
04 6838 XXX	29	04 6899 010	27	40 3599 610	22	41 8192 7XX	18	48 4901 70X	41
04 6838 XXX	29	04 6899 020	27	40 3599 611	22	41 8193 7XX	18	48 4911 00X	40
04 6842 1XX	28	04 6899 022	27	40 3620 00X	38	41 8604 7XX	9	48 4970 6XX	40
04 6845 XXX	28	04 6899 050	27	40 4409 XXX	39	41 9605 7XX	9	48 4971 0XX	40
04 6847 0XX	29	40 1832 00X	38	40 5000 0XX	41	42 0811 7XX	11	48 4973 00X	40
04 6848 0XX	29	40 1833 00X	38	40 5000 1XX	41	42 0813 7XX	11	48 4973 0XX	40
04 6849 935	32	40 1834 00X	38	40 5001 0XX	41	42 0881 708	11	48 4975 7XX	9
04 6856 018	28	40 1835 00X	38	40 5005 026	42	42 0889 7XX	11	48 4975 7XX	9
04 6856 118	34	40 2022 1XX	35	40 5026 0XX	41	42 7141 7XX	3	48 4976 73X	9
04 6857 033	29	40 2022 8XX	36	40 5027 0XX	41	42 7177 03X	17	48 4976 7XX	9
04 6859 XXX	39	40 3568 006	21	40 5494 303	42	42 7340 7XX	3	74 0923 7XX	9
04 6863 2XX	26	40 3568 106	21	40 5494 304	42	42 7497 7XX	5	74 0938 0XX	17
04 6864 2XX	26	40 3568 206	21	40 5495 354	42	42 7872 70X	6	74 3523 0XX	9
04 6865 2XX	26	40 3569 0XX	38	40 5501 00X	43	42 7872 7XX	32		
04 6867 2XX	25	40 3570 0XX	38	40 5512 301	43	42 7916 7XX	10		
04 6868 2XX	25	40 3571 0XX	38	40 5516 300	42	42 7920 7XX	10		
04 6868 903	25	40 3571 800	27	40 5524 303	42	42 7921 7XX	2		
04 6868 907	25	40 3573 006	27	40 5524 304	42	42 7922 7XX	2		
04 6868 908	24	40 3574 0XX	38	40 5525 354	43	42 7923 7XX	2		
04 6868 911	25	40 3574 800	27	40 5526 003	42	42 7924 7XX	2		
04 6868 920	25	40 3575 0XX	38	40 5526 004	42	42 7929 0XX	2		
04 6868 930	33	40 3578 000	37	40 5526 354	43	42 7931 7XX	7		
04 6870 XXX	26	40 3578 002	37	40 5527 000	42	42 7943 7XX	7		
04 68778 808	24	40 3578 300	37	40 5529 005	42	42 7949 702	7		
04 6878 2XX	24	40 3578 600	37	40 5622 304	42	42 7970 7XX	4		
04 6878 4XX	24	40 3578 620	37	40 5622 354	43	42 8119 7XX	6		
04 6878 888	24	40 3578 630	37	40 6662 0XX	15	42 8120 7XX	6		
04 6878 908	24	40 3578 635	37	40 6887 2XX	31	42 8122 70X	6		
04 6879 121	21	40 3578 640	37	40 7112 133	15	42 8188 76X	8		
04 6879 902	25	40 3582 301	19	40 7115 244	15	42 8188 7XX	8		
04 6879 908	25	40 3582 392	19	40 7116 246	15	42 8189 1XX	18		
04 6879 9XX	35	40 3582 393	19	40 7124 704	15	42 8189 30X	18		
04 6880 2XX	24	40 3582 3XX	19	40 7129 146	15	42 8404 0XX	4		
04 6881 2XX	24	40 3582 450	23	40 7139 806	15	42 8494 7XX	4		
04 6882 202	34	40 3582 50X	20	41 0080 0XX	14	42 8495 7XX	4		
04 6882 203	34	40 3582 52X	20	41 7936 73X	7	42 8496 7XX	4		
04 6882 204	34	40 3582 60X	20	41 7936 7XX	7	42 9119 7XX	3		
04 6882 402	33	40 3582 62X	20	41 8051 7XX	10	42 9489 1XX	5		
04 6882 403	33	40 3582 64X	20	41 8072 7XX	3	42 9494 7XX	5		
04 6882 404	33	40 3582 701	21	41 8100 7XX	6	42 9495 7XX	5		
04 6882 906	34	40 3582 70X	20	41 8102 7XX	6	42 9499 7XX	5		
04 6882 916	33	40 3582 800	23	41 8104 7XX	6	43 0335 0XX	14		
04 6882 926	34	40 3582 810	23	41 8122 7XX	3	43 0335 7XX	14		
04 6882 946	34	40 3585 104	39	41 8131 7XX	3	43 0335 8XX	14		
04 6882 954	34	40 3585 124	39	41 8137 7XX	2	43 0338 0XX	14		
04 6885 2XX	29	40 3589 060	32	41 8139 03X	16	43 0377 7XX	13		
04 6885 6XX	28	40 3589 107	39	41 8139 XXX	17	43 0382 7XX	13		
04 6885 XXX	30	40 3596 00X	38	41 8175 0XX	16	43 0453 0XX	14		
04 6889 1XX	30	40 3596 300	19	41 8176 05X	17	43 0461 0XX	14		
04 6889 7XX	30	40 3596 328	19	41 8176 07X	17	44 7081 0XX	15		
04 6889 8XX	30	40 3596 330	19	41 8176 08X	17	44 7082 00X	32		
04 6889 916	32	40 3596 331	19	41 8176 09X	17	44 7082 0XX	15		
04 6890 2XX	30	40 3596 332	19	41 8176 1XX	17	44 7085 0XX	15		
04 6891 218	32	40 3596 332	19	41 8176 1XX	16	44 9110 0XX	13		
04 6891 2XX	30	40 3596 342	19	41 8176 2XX	16	44 9115 0XX	13		
04 6893 0XX	31	40 3596 352	19	41 8176 3XX	16	44 9119 0XX	13		
04 6893 1XX	31	40 3596 353	19	41 8177 0XX	16	46 4230 0XX	4		
04 6893 X22	31	40 3596 524	22	41 8177 22X	16	46 6202 635	19		
04 6894 0XX	31	40 3596 530	19	41 8177 3XX	16	46 6202 780	25		
04 6894 1XX	31	40 3596 724	32	41 8183 7XX	10	46 6202 830	19		
04 6895 015	34	40 3597 601	22	41 8184 7XX	10	46 6209 106	31		
04 6895 125	33	40 3597 602	22	41 8185 7XX	10	46 6209 708	21		
04 6895 50X	33	40 3597 880	23	41 8186 7XX	10	46 6209 730	21		
04 6895 6XX	33	40 3597 920	23	41 8188 7XX	8	46 6209 740	21		
04 6896 016	34	40 3598 610	22	41 8188 7XX	8	46 6209 745	21		
04 6896 026	33	40 3598 611	22	41 8188 83X	8	46 6209 801	21		

VAND / WATER / WASSER

Side / Page /
Site 2 - 17



GAS / GAS / GAS

Side / Page /
Site 18



GULVVARME / MANIFOLDS / VERTEILER

Side / Page /
Site 19 - 36



VARME / HEATING / HEIZUNG

Side / Page /
Site 37 - 43

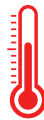

HVAC

Side / Page /
Site 44 - 46



NEW



Preskuglehaner i afzinkningsfri messing CW511L.

Press ball valves in corrosion resistant material CW511L

Preß Kugelhahn in Korrosionsfester Legierung CW511L

Side 4-5 / Page 4-5 / Seite 4-5

NEW



Ventiler til varmt brugsvands-cirkulation. I blyfri og korrosionsbestandigt messing CW511L.

Valves for hot water circulation. In lead-free and corrosion resistant brass CW511L.

Ventile für die Warmwasserzirkulation. Aus bleifreiem und korrosionsbeständigem Messing CW511L.

Side 7 / Page 7 / Seite 7

NEW



Vejrkompenseringsanlæg med fortrådet eller trådløs udeføler.

Weather compensation system with wired or wireless outdoor sensor.

Wetterkompensationssystem mit kabelgebundenem oder kabellosem Außensensor.

Side 19 / Page 19 / Seite 19

NEW



Pakkøløsninger til gulvvarme, med Premium rumtermostat. UD af æsken, OP på væggen.

Package for underfloor heating, with Premium room thermostat.

Paket für Fußbodenheizung, mit Premium Raumthermostat.

Side 20 / Page 20 / Seite 20

NEW

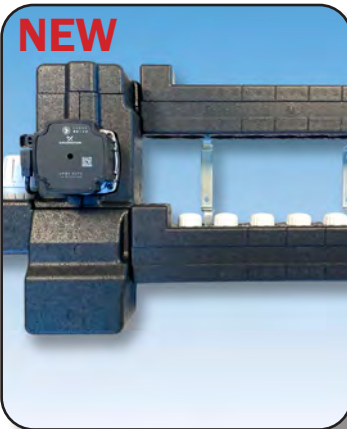

NY serie 7025 fordelersystem med isolering i EPP (Ekspanderet polypropylen).

NEW series 7025 distribution system with insulation in EPP (Expanded polypropylene).

NEUES Verteilersystem der Serie 7025 mit Isolierung aus EPP (Expandiertes Polypropylen).

Side 24 / Page 24 / Seite 24

NEW



Dynamisk strengreguleringsventil "Dynasty" med lineær karakteristik og målerudtag for måling af tryk og temperatur.

Pressure Independent Control valve "Dynasty" with linear characteristic and measuring outlet for pressure and temperature.

Dynamisches Strangregelventil „Dynasty“ mit linearer Kennlinie, zur Messung von Druck und Temperatur

Side 44-45/Page 44-45/Seite 44-45

NEW



Dynamisk strengreguleringsventil "Dynasty" med lineær karakteristik. N x N. Inkl. filter indsats.

Pressure Independent Control Valve "Dynasty" with linear characteristic. N x N. Including filter.

Dynamisches Strangregelventil „Dynasty“ mit linearer Kennlinie. N x N. Inkl. Filtereinsatz.

Side 44-45/Page 44-45/Seite 44-45

NEW



PCS formonteret ventil sæt, by-pass (70 mm centerafstand) serie 92 PICV, filter / afspærringsventil.

PCS preassembled valve kit, flushing by-pass (70 mm interaxis) with 92 Series PICV, FilterBall strainer / shut-off valve.

Vormontierter PCS-Ventilsatz, Bypass (70 mm Achsenabstand) mit PICV der Serie 92, Filter-Ball-Sieb/Absperrventil.

Side 44-45/Page 44-45/Seite 44-45

FLEXIBILITY AND QUALITY

Mere end 85 års erfaring • More than 85 years of experience • Mehr als 85 Jahre Erfahrung

 Stort og bredt produktsortiment fra en af verdens førende producenter af enkeltkomponenter og systemløsninger til VVS-branchen.

Pettinaroli kan tilbyde kuglehæner, ventiler og gulvvarmesystemer af høj kvalitet. Pettinaroli har været på markedet i mere end 85 år, så vi har stor faglig ekspertise indenfor produkter til VVS-branchen.

Pettinarolis kuglehæneprogram er udviklet, så det er super fleksiblt. Med få grundelementer, kan de kombineres på et utal af måder, så ventiler fremkommer i en lang række varianter med forskellige greb og tilslutninger.

I dette katalog findes standardprodukter. Er der ønsker til kombinationer af greb og tilslutninger, som ikke forefindes i kataloget, bedes I henvende jer til vores kontor i Middelfart på info@pettinarioli.dk eller tlf. 6341 0900.

 Large and wide product range from one of the world's leading manufacturers of individual components and system solutions for the plumbing industry.

Pettinaroli can offer high quality ball valves, valves and underfloor heating systems. Pettinaroli has been on the market for more than 85 years, so we have great professional expertise within products for the plumbing industry.

Pettinaroli's ball valve range has been developed to be super flexible. With a few basic elements, they can be combined in countless ways, so that valves appear in a wide range of variants with different handles and connections.

This catalog contains standard products. If there are wishes for combinations of handles and connections that are not found in the catalogue, please contact our office in Middelfart at info@pettinarioli.dk or tel. +45 6341 0900.

 Großes und breites Produktsortiment von einem der weltweit führenden Hersteller von Einzelkomponenten und Systemlösungen für die Sanitärbranche.

Pettinaroli kann hochwertige Kugelhähne, Ventile und Fußbodenheizungssysteme anbieten. Pettinaroli ist seit mehr als 85 Jahren auf dem Markt und verfügt daher über große Fachkompetenz bei Produkten für die Sanitärbranche.

Das Kugelhähnsortiment von Pettinaroli wurde im Hinblick auf höchste Flexibilität entwickelt. Mit wenigen Grundelementen lassen sie sich auf unzählige Arten kombinieren, sodass Ventile in vielfältigen Varianten mit unterschiedlichen Griffen und Anschlüssen erscheinen.

Dieser Katalog enthält Standardprodukte. Wenn Sie Kombinationen von Griffen und Verbindungen wünschen, die nicht im Katalog enthalten sind, wenden Sie sich bitte an unser Büro in Middelfart unter info@pettinarioli.dk oder Tel. +45 6341 0900.

NEW PRODUCTION FACILITIES



I 2024 har Pettinaroli, Danmark udvidet lager- og produktionsfaciliteterne med 999 m². Dette for at imødekomme kundernes krav om fleksibilitet og hurtig levering.

In 2024, Pettinaroli, Denmark expanded its warehouse and production facilities by 999 m² to meet customer demands for flexibility and fast delivery.

Im Jahr 2024 hat Pettinaroli, Dänemark, die Lager- und Produktionsanlagen um 999 m² erweitert. Damit soll den Ansprüchen der Kunden nach Flexibilität und schneller Lieferung entsprochen werden.



Approvals



Scan QR koden og find alle godkendelser.

Scan the QR code and find all approvals.

Scannen Sie den QR-Code und finden Sie alle Zulassungen.

Approvals

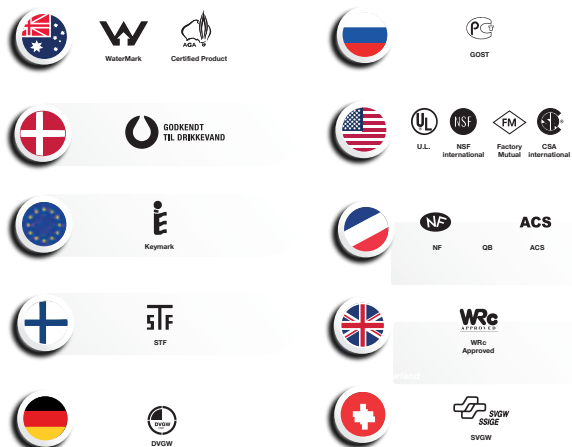

QR codes



QR koderne i dette katalog leder dig ind på Pettinarolis produktsider, hvor du blandt andet kan finde tekniske specifikationer på produkterne.

The QR codes in this catalog will direct you to Pettinaroli's product pages, where you can find technical specifications for the products, among other things.

Die QR-Codes in diesem Katalog führen Sie zu den Produktseiten von Pettinaroli, wo Sie unter anderem technische Spezifikationen zu den Produkten finden.



51L

Kraftig kuglehane med høj hals og fuldt gennemløb. TEA overfladebehandling. Muffe/muffe. Grønt stålhåndtag.

F x F heavyduty fullway ball valve with extended neck and with TEA treatment. Green steel lever.

I x I Schwerer Kugelhahn mit vollem Durchgang und TEA Oberfläche. Long Neck. Grüner Stahlhebel.

ART.NO.	DIMENSION	VVS	BOX	STATUS
55EU-002*	1/4"	41 8137 702	12 / 72	✓
55EU-003*	3/8"	41 8137 703	12 / 72	✓
51L-004	1/2"	42 7911 004	10 / 40	✓
51L-006	3/4"	42 7911 006	8 / 32	✓
51L-008	1"	42 7911 008	4 / 16	✓
51L-010	1.1/4"	42 7911 010	4 / 16	✓
51L-011	1.1/2"	42 7911 011	2 / 4	✓
51L-012	2"	42 7911 012	2 / 4	✓
55EU-013*	2.1/2"	41 8137 713	2	✓
55EU-014*	3"	41 8137 714	1	✓

* med spindelforlænger / with spindle extension / mit Spindelverlängerung



IS51

Isolering i polyethylen til Pettinaroli kuglehane. Incl. to clips for nem montering.

Isolation of polyethylene for Pettinaroli ball valves. Incl. two clips for easy installation.

Isolation aus Polyethylen für Pettinaroli Kugelhähne. Inkl. zwei Clips für einfache Installation.

ART.NO.	DIMENSION	VVS	BOX	STATUS
IS51-004	1/2"	42 7929 004	1	✓
IS51-006	3/4"	42 7929 006	1	✓
IS51-008	1"	42 7929 008	1	✓
IS51-010	1.1/4"	42 7929 010	1	✓
IS51-011	1.1/2"	42 7929 011	1	✓
IS51-012	2"	42 7929 012	1	✓



51EU

Kraftig kuglehane med fuldt gennemløb. TEA overfladebehan ling. Muffe/muffe. Grønt stålhåndtag.

F x F heavyduty fullway ball valve with TEA treatment. Green steel lever.

I x I Schwerer Kugelhahn mit vollem Durchgang. TEA Oberfläche. Grüner Stahlhebel.

ART.NO.	DIMENSION	VVS	BOX	STATUS
51EU-002	1/4"	42 7921 702	12 / 120	✓
51EU-003	3/8"	42 7921 703	12 / 120	✓
51EU-004	1/2"	42 7921 704	12 / 120	✓
51EU-006	3/4"	42 7921 706	12 / 48	✓
51EU-008	1"	42 7921 708	6 / 36	✓
51EU-010	1.1/4"	42 7921 710	4 / 24	✓
51EU-011	1.1/2"	42 7921 711	2 / 16	✓
51EU-012	2"	42 7921 712	2 / 12	✓
51EU-013	2.1/2"	42 7921 713	- / 3	✓
51EU-014	3"	42 7921 714	- / 2	✓
51EU-016	4"	42 7921 716	- / 1	✓



51EU/1

Kraftig kuglehane med fuldt gennemløb. TEA overfladebehan ling. Muffe/nippel. Grønt stålhåndtag.

F x M heavyduty fullway ball valve with TEA treatment. Green steel lever.

I x A Schwerer Kugelhahn mit vollem Durchgang. TEA Oberfläche. Grüner Stahlhebel.

ART.NO.	DIMENSION	VVS	BOX	STATUS
51EU/1-002	1/4"	42 7922 702	12 / 120	✓
51EU/1-003	3/8"	42 7922 703	12 / 120	✓
51EU/1-004	1/2"	42 7922 704	12 / 120	✓
51EU/1-006	3/4"	42 7922 706	10 / 60	✓
51EU/1-008	1"	42 7922 708	6 / 36	✓
51EU/1-010	1.1/4"	42 7922 710	4 / 24	✓
51EU/1-011	1.1/2"	42 7922 711	2 / 16	✓
51EU/1-012	2"	42 7922 712	2 / 12	✓



51EU/2

Kraftig kuglehane med fuldt gennemløb. TEA overfladebehan ling. Nippel/nippel. Grønt stålhåndtag.

M x M heavyduty fullway ball valve with TEA treatment. Green steel lever.

A x A Schwerer Kugelhahn mit vollem Durchgang. TEA Oberfläche. Grüner Stahlhebel.

ART.NO.	DIMENSION	VVS	BOX	STATUS
51EU/2-002	1/4"	42 7923 702	12 / 120	✓
51EU/2-003	3/8"	42 7923 703	12 / 120	✓
51EU/2-004	1/2"	42 7923 704	12 / 120	✓
51EU/2-006	3/4"	42 7923 706	10 / 60	✓
51EU/2-008	1"	42 7923 708	6 / 36	✓
51EU/2-010	1.1/4"	42 7923 710	4 / 24	✓
51EU/2-011	1.1/2"	42 7923 711	2 / 16	✓
51EU/2-012	2"	42 7923 712	2 / 12	✓



51EU/3

Kraftig kuglehane med fuldt gennemløb. TEA overfladebehan ling. Muffe/forskrubning. Grønt stålhåndtag.

Heavyduty fullway femaleball valve with tail and TEA treatment. Green steel lever.

Schwerer Kugelhahn mit vollem Durchgang I x A mit Verschraubung. TEA Oberfläche. Grüner Stahlhebel.

ART.NO.	DIMENSION*	VVS	BOX	STATUS
51EU/3-004	1/2" x 1/2"	42 7924 704	12 / 72	✓
51EU/3-006	3/4" x 3/4"	42 7924 706	8 / 48	✓
51EU/3-008	1" x 1"	42 7924 708	5 / 30	✓
51EU/3-010	1.1/4" x 1.1/4"	42 7924 710	4 / 16	✓

*muffe x nippel/FxM / I x A

For approvals and tech. spec., see QR-code or www.pettinaroli.dk

✓ in stock in Middelfart, X 2-4 weeks



52EUR

Kraftig kuglehane med fuldt gennemløb. TEA overfladebehan ling. Muffe/muffe. Rødt T-greb.

F x F heavyduty fullway ball valve with TEA treatment. Red butterfly handle

I x I Schwere Kugelhahn mit vollem Durchgang, TEA Oberfläche und rotem Flügelgriff.

ART.NO.	DIMENSION	VVS	BOX	STATUS
52EUR-002	1/4"	41 8119 702	12 / 120	✓
52EUR-003	3/8"	41 8119 703	12 / 120	✓
52EUR-004	1/2"	41 8119 704	10 / 100	✓
52EUR-006	3/4"	41 8119 706	6 / 60	✓
52EUR-008	1"	41 8119 708	4 / 40	✓
52EUR-010	1.1/4"	41 8119 710	2 / 20	✓



52EUR/1

Kraftig kuglehane med fuldt gennemløb. TEA overfladebehan ling. Muffe/nippel. Rødt T-greb.

F x M heavyduty fullway ball valve with TEA treatment. Red butterfly handle

I x A Schwere Kugelhahn mit vollem Durchgang, TEA Oberfläche und rotem Flügelgriff.

ART.NO.	DIMENSION	VVS	BOX	STATUS
52EUR/1-002	1/4"	41 8120 702	12 / 120	✓
52EUR/1-003	3/8"	41 8120 703	12 / 120	✓
52EUR/1-004	1/2"	41 8120 704	12 / 120	✓
52EUR/1-006	3/4"	41 8120 706	6 / 60	✓
52EUR/1-008	1"	41 8120 708	4 / 40	✓
52EUR/1-010	1.1/4"	41 8120 710	2 / 20	✓



52EUR/2

Kraftig kuglehane med fuldt gennemløb. TEA overfladebehan ling. Nippel/nippel. Rødt T-greb.

M x M heavyduty fullway ball valve with TEA treatment. Red butterfly handle

A x A Schwere Kugelhahn mit vollem Durchgang, TEA Oberfläche und rotem Flügelgriff.

ART.NO.	DIMENSION	VVS	BOX	STATUS
52EUR/2-002	1/4"	41 8122 702	10 / 100	✓
52EUR/2-003	3/8"	41 8122 703	12 / 120	✓
52EUR/2-004	1/2"	41 8122 704	12 / 120	✓
52EUR/2-006	3/4"	41 8122 706	6 / 60	✓
52EUR/2-008	1"	41 8122 708	4 / 40	✓
52EUR/2-010	1.1/4"	41 8122 710	2 / 20	✓



53EU

Kraftig kuglehane med fuldt gennemløb. TEA overfladebehan ling. Muffe/muffe. Gearhåndtag.

F x F heavyduty fullway ball valve with TEA treatment and gear handle.

I x I Schwere Kugelhahn mit vollem Durchgang, TEA Oberfläche und Handrad mit Planeten-Getriebe.

ART.NO.	DIMENSION	VVS	BOX	STATUS
53EU-002	1/4"	41 8131 702	10 / 80	✓
53EU-003	3/8"	41 8131 703	10 / 80	✓
53EU-004	1/2"	41 8131 704	8 / 64	✓
53EU-006	3/4"	41 8131 706	7 / 56	✓
53EU-008	1"	41 8131 708	6 / 36	✓
53EU-010	1.1/4"	41 8131 710	6 / 12	✓
53EU-011	1.1/2"	41 8131 711	4 / 8	✓
53EU-012	2"	41 8131 712	2 / 4	✓



52TEU

Kraftig kuglehane med fuldt gennemløb. TEA overfladebehan ling. Muffe/muffe. Højt plast T-greb med grøn markering.

F x F heavyduty fullway ball valve with TEA treatment. Extended plastic lever.

I x I Schwere Kugelhahn mit vollem Durchgang, TEA Oberfläche und Kunststoffgriff.

ART.NO.	DIMENSION	VVS	BOX	STATUS
52TEU-002	1/4"	42 7140 702	12 / 120	✓
52TEU-003	3/8"	42 7140 703	12 / 120	✓
52TEU-004	1/2"	42 7140 704	10 / 100	✓
52TEU-006	3/4"	42 7140 706	6 / 60	✓
52TEU-008	1"	42 7140 708	4 / 40	✓
52TEU-010	1.1/4"	42 7140 710	2 / 20	✓



52TEU/1

Kraftig kuglehane med fuldt gennemløb. TEA overfladebehan ling. Muffe/nippel. Højt plast T-greb med grøn markering.

F x M heavyduty fullway ball valve with TEA treatment. Extended plastic lever.

I x A Schwere Kugelhahn mit vollem Durchgang, TEA Oberfläche und Kunststoffgriff.

ART.NO.	DIMENSION	VVS	BOX	STATUS
52TEU/1-002	1/4"	42 7141 702	12 / 120	✓
52TEU/1-003	3/8"	42 7141 703	10 / 100	✓
52TEU/1-004	1/2"	42 7141 704	10 / 100	✓
52TEU/1-006	3/4"	42 7141 706	6 / 60	✓
52TEU/1-008	1"	42 7141 708	4 / 40	✓
52TEU/1-010	1.1/4"	42 7141 710	2 / 20	✓



58EU

Kraftigt kuglehane med låsbar top og fuldt gennemløb. TEA overfladebehandling Muffe/muffe. Grønt stålhåndtag.

F x F heavyduty fullway ball valve with lockable device and with TEA treatment. Green steel lever.

I x I Schwerer Kugelhahn mit vollem Durchgang und TEA Oberfläche. Verschleißbarem Oberteil und grüner Stahlhebel.

ART.NO.	DIMENSION	VVS	BOX	STATUS
58EU-002	1/4"	42 7970 702	16 / 64	✓
58EU-003	3/8"	42 7970 703	16 / 64	✓
58EU-004	1/2"	42 7970 704	12 / 48	✓
58EU-006	3/4"	42 7970 706	10 / 40	✓
58EU-008	1"	42 7970 708	4 / 24	✓
58EU-010	1.1/4"	42 7970 710	2 / 20	✓
58EU-011	1.1/2"	42 7970 711	4 / 18	✓
58EU-012	2"	42 7970 712	2 / 8	✓

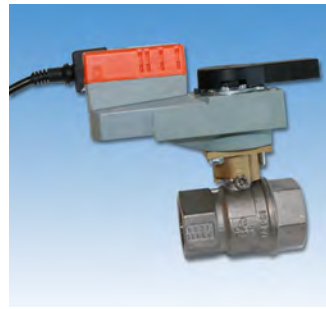

51EUM

Motorstyret ventil til proces- og varmeanlæg. Undgå vandspild og vandskader ved lækager.

Motorised valves for process and heating systems. Avoid wastage of water and water damage from leaks. TEA treated.

Motorisierte Ventile für Prozess- und Heizungsanlagen. Vermeiden Verschwendung von Wasser und damit Schäden durch Leckagen. TEA Oberfläche.

ART.NO.	DIMENSION	VVS	BOX	STATUS
51EUM-004	1/2"	46 4230 004	1	X
51EUM-006	3/4"	46 4230 006	1	X
51EUM-008	1"	46 4230 008	1	X
51EUM-010	1.1/4"	46 4230 010	1	X
51EUM-011	1.1/2"	46 4230 011	1	X
51EUM-012	2"	46 4230 012	1	X



P100L

Preskuglehane med høj hals og fuldt gennemløb. Afzinkningsfri messing m/TEA overfladebehandling. Grønt stålhåndtag. Pres x pres.

Heavyduty fullway ball valve with press fittings ends and extended neck. Corrosion resistant material with TEA treatment. Green steel lever. Press x press.

Kugelhahn mit vollem Durchgang, Preßfittings und Long Neck. Korrosionsfester Legierung mit TEA Oberfläche. Grüner Stahlhebel. Preß x Preß.

ART. NO.	DIMENSION*	VVS	BOX	STATUS
P100L-015	15 x 15	42 8404 015	10 / 40	✓
P100L-018	18 x 18	42 8404 018	10 / 40	✓
P100L-022	22 x 22	42 8404 022	8 / 32	✓
P100L-028	28 x 28	42 8404 028	4 / 16	✓
P100L-035	35 x 35	42 8404 035	4 / 16	✓
P100L-042	42 x 42	42 8404 042	2 / 4	✓
P100L-054	54 x 54	42 8404 054	2 / 4	✓

*V+M: dim. 15, 18, 22, 28, 35 / V: dim. 42, 54

**Isolering side 1 / Isolation page 1 / Isolation Seite 1



P100

Kuglehane med presfittings. Grønt stålhåndtag. Afzinkningsfri messing CW511L m/TEA overfladebehandling. Pres x pres.

Heavyduty fullway ball valve with press x press fittings ends. Corrosion resistant material CW511L with TEA treatment. Green steel lever.

Kugelhahn mit vollem Durchgang. Preß x Preßfittings. Korrosionsfester Legierung CW511L mit TEA Oberfläche. Grüner Stahlhebel.

ART. NO.	DIMENSION*	VVS	BOX	STATUS
P100-015	15 x 15	42 8494 715	10 / 60	✓
P100-018	18 x 18	42 8494 718	10 / 60	✓
P100-022	22 x 22	42 8494 722	10 / 40	✓
P100-028	28 x 28	42 8494 728	8 / 32	✓
P100-035	35 x 35	42 8494 735	4 / 24	✓
P100-042	42 x 42	42 8494 742	1 / 4	✓
P100-054	54 x 54	42 8494 754	1 / 4	✓

*V+M: dim. 15, 18, 22, 28, 35 / V: dim. 42, 54



P100/0

Kuglehane med presfittings. Grønt stålhåndtag. Afzinkningsfri messing CW511L m/TEA overfladebehandling. Muffe x pres.

Heavyduty fullway ball valve with press x F fittings ends. Corrosion resistant material CW511L with TEA treatment. Green steel lever.

Kugelhahn mit vollem Durchgang. Preß x IG fittings. Korrosionsfester Legierung mit TEA Oberfläche. Grüner Stahlhebel.

ART. NO.	DIMENSION*	VVS	BOX	STATUS
P100/0-415	15 x 1/2"	42 8495 715	10 / 60	✓
P100/0-618	18 x 3/4"	42 8495 719	10 / 60	✓
P100/0-622	22 x 3/4"	42 8495 722	10 / 40	✓
P100/0-828	28 x 1"	42 8495 728	8 / 32	✓
P100/0-A35	35 x 1.1/4"	42 8495 735	4 / 24	✓
P100/0-B42	42 x 1.1/2"	42 8495 742	1 / 4	✓
P100/0-C54	54 x 2"	42 8495 754	1 / 4	✓

*V+M: dim. 15, 18, 22, 28, 35 / V: dim. 42, 54

For approvals and tech. spec., see QR-code or www.pettinaroli.dk



P100/1

Kuglehane med presfittings. Grønt stålhåndtag. Afzinkningsfri messing CW511L m/TEA overfladebehandling. Nippel x pres.

Heavyduty fullway ball valve with press x M fittings ends. Corrosion resistant material CW511L with TEA treatment. Green steel lever.

Kugelhahn mit vollem Durchgang. Preß x AG fittings. Korrosionsfester Legierung CW511L mit TEA Oberfläche. Grüner Stahlhebel.

ART. NO.	DIMENSION*	VVS	BOX	STATUS
P100/1-415	15 x 1/2"	42 8496 715	10 / 60	✓
P100/1-618	18 x 3/4"	42 8496 719	10 / 60	✓
P100/1-622	22 x 3/4"	42 8496 722	10 / 40	✓
P100/1-828	28 x 1"	42 8496 728	8 / 32	✓
P100/1-A35	35 x 1.1/4"	42 8496 735	4 / 24	✓
P100/1-B42	42 x 1.1/2"	42 8496 742	1 / 4	✓
P100/1-C54	54 x 2"	42 8496 754	1 / 4	✓

*V+M: dim. 15, 18, 22, 28, 35 / V: dim. 42, 54

✓ in stock in Middelfart, X 2-4 weeks



P102

Kuglehane med presfittings. Blåt al minium T-greb. Afzinkningsfri messing CW511L m/ TEA overfladebehandling. Pres x pres.

Heavyduty fullway ball valve with press x press fittings ends. Corrosion resistant material CW511L with TEA treatment. Blue butterfly handle.

Kugelhahn mit vollem Durchgang. Preß x Preßfittings. Korrosionsfester Legierung CW511L mit TEA Oberfläche. Blauer Flügelgriff.

ART. NO.	DIMENSION*	VVS	BOX	STATUS
P102-015	15 x 15	42 9494 715	10 / 60	✓
P102-018	18 x 18	42 9494 718	10 / 60	✓
P102-022	22 x 22	42 9494 722	10 / 40	✓
P102-028	28 x 28	42 9494 728	8 / 32	✓

*V+M: dim. 15, 18, 22, 28



P102/0

Kuglehane med presfittings. Blåt aluminium T-greb. Afzinkningsfri messing CW511L m/ TEA overfladebehandling. Muffe x pres.

Heavyduty fullway ball valve with press x F fittings ends. Corrosion resistant material CW511L with TEA treatment. Blue butterfly handle.

Kugelhahn mit vollem Durchgang. Preß x IG fittings. Korrosionsfester Legierung CW511L mit TEA Oberfläche. Blauer Flügelgriff.

ART. NO.	DIMENSION*	VVS	BOX	STATUS
P102/0-415	15 x 1/2"	42 9495 715	10 / 60	✓
P102/0-618	18 x 3/4"	42 9495 719	10 / 60	✓
P102/0-622	22 x 3/4"	42 9495 722	10 / 40	✓
P102/0-828	28 x 1"	42 9495 728	8 / 32	✓

*V+M: dim. 15, 18, 22, 28



P102T

Kuglehane med presfittings. Hjt sort plast T-greb. Afzinkningsfri messing CW511L m/ TEA overfladebehandling. Pres x pres.

Heavyduty fullway ball valve with press x press fittings ends. Corrosion resistant material CW511L with TEA treatment. Long black plastic lever.

Kugelhahn mit vollem Durchgang. Korrosionsfester Legierung CW511L mit TEA Oberfläche. Verlängerter schwarzer Flügelgriff. Preß x Preß.

ART. NO.	DIMENSION*	VVS	BOX	STATUS
P102T-015	15 x 15	42 7497 715	10 / 60	✓
P102T-018	18 x 18	42 7497 718	10 / 60	✓
P102T-022	22 x 22	42 7497 722	10 / 40	✓
P102T-028	28 x 28	42 7497 728	8 / 32	✓

*V+M: dim. 15, 18, 22, 28



P102/4R

Kuglehane med presfittings og omløber. Rødt aluminium T-greb. Afzinkningsfri messing m/ TEA overfladebehandling. Pres x omløber.

Heavyduty fullway ball valve with press fitting end and swivel. Corrosion resistant material with TEA treatment. Red butterfly handle. Press x Swivel.

Kugelhahn, Korrosionsfester Legierung mit TEA Oberfläche. Preßfitting und Überwurfmutter. Roter Flügelgriff. Preß x Überwurfmutter.

ART. NO.	DIMENSION*	VVS	BOX	STATUS
P102/4R-618	18 x 3/4"	42 9489 118	10 / 100	✓
P102/4R-622	22 x 3/4"	42 9489 122	10 / 100	✓

*V+M: dim. 18, 22



P102/4

Kuglehane med presfittings og omløber. Blåt aluminium T-greb. Afzinkningsfri messing m/ TEA overfladebehandling. Pres x omløber.

Heavyduty fullway ball valve with press fitting end and swivel. Corrosion resistant material with TEA treatment. Blue butterfly handle. Press x Swivel.

Kugelhahn, Korrosionsfester Legierung mit TEA Oberfläche. Preßfitting und Überwurfmutter. Blauer Flügelgriff. Preß x Überwurfmutter.

ART. NO.	DIMENSION*	VVS	BOX	STATUS
P102/4-615	15 x 3/4"	42 9499 716	10 / 100	✓
P102/4-618	18 x 3/4"	42 9499 719	10 / 100	✓
P102/4-622	22 x 3/4"	42 9499 722	10 / 100	✓

*V+M: dim. 15, 18, 22

For approvals and tech. spec., see QR-code or www.pettinaroli.dk

IST175

PRODUCT INFORMATION

The Ball Valve will be delivered in open position. Test the function immediately after the installation. To secure a proper function of the Ball Valve, especially in potable water installations with high hydro carbonate content, it will be necessary to operate the Ball Valve 6 times/year.

PRODUKTINFORMATION

Der Kugelhahn wird in offener Position geliefert werden. Testen Sie die Funktion sofort nach der Installation. Um eine einwandfreie Funktion des Kugelhahn, vor allem in Trinkwasserinstallationen mit hohem Hydrokarbonat Gehalt zu sichern, wird es notwendig sein, den Betrieb der Kugelhahn 6 mal / Jahr zu bedienen.

PRODUKTINFORMATION

Kuglehanen leveres i åben stilling. Kontroller straks efter installationen at kuglehanen fungerer optimalt. For at tilsiere en god funktion af kuglehanen, specielt i drikkevandsinstallationer med højt indhold af hydro karbonat, anbefales det at betjene kuglehanen 6 gange / år.

✓ in stock in Middelfart, X 2-4 weeks



51CE

Kuglehane "New Compact" med fuldt gennemløb. Muffe/muffe. Rødt stålhåndtag.

F x F "New Compact" fullway ball valve. Red steel lever.

I x I Kugelhahn "New Compact" mit vollem Durchgang und rotem Stahlhebel.

ART. NO.	DIMENSION	WVS	BOX	STATUS
51CE-004	1/2"	41 8102 704	24 / 96	✓
51CE-006	3/4"	41 8102 706	12 / 48	✓
51CE-008	1"	41 8102 708	8 / 48	✓
51CE-010	1.1/4"	41 8102 710	5 / 30	✓
51CE-011	1.1/2"	41 8102 711	3 / 24	✓
51CE-012	2"	41 8102 712	2 / 16	✓



51CE/1

Kuglehane "New Compact" med fuldt gennemløb. Muffe/nippel. Rødt stålhåndtag.

F x M "New Compact" fullway ball valve. Red steel lever.

I x A Kugelhahn "New Compact" mit vollem Durchgang und rotem Stahlhebel.

ART. NO.	DIMENSION	WVS	BOX	STATUS
51CE/1-004	1/2"	41 8100 704	20 / 80	✓
51CE/1-006	3/4"	41 8100 706	12 / 48	✓
51CE/1-008	1"	41 8100 708	8 / 48	✓



51CE/2

Kuglehane "New Compact" med fuldt gennemløb. Nippel/nippel. Rødt stålhåndtag.

M x M "New Compact" fullway ball valve. Red steel lever.

A x A Kugelhahn "New Compact" mit vollem Durchgang und rotem Stahlhebel.

ART. NO.	DIMENSION	WVS	BOX	STATUS
51CE/2-004	1/2"	41 8104 704	18 / 72	✓
51CE/2-006	3/4"	41 8104 706	12 / 48	✓
51CE/2-008	1"	41 8104 708	8 / 48	✓



52CE

Kuglehane "New Compact" med fuldt gennemløb. Muffe/muffe. Rødt T-greb.

F x F "New Compact" fullway ball valve. Red butterfly handle

I x I Kugelhahn "New Compact" mit vollem Durchgang und rotem Flügelgriff.

ART. NO.	DIMENSION	WVS	BOX	STATUS
52CE-004	1/2"	42 8119 704	20 / 80	✓
52CE-006	3/4"	42 8119 706	12 / 48	✓
52CE-008	1"	42 8119 708	9 / 36	✓
52CE-010	1.1/4"	42 8119 710	6 / 24	✓



52CE/1

Kuglehane "New Compact" med fuldt gennemløb. Muffe/nippel. Rødt T-greb.

F x M "New Compact" fullway ball valve. Red butterfly handle

I x A Kugelhahn "New Compact" mit vollem Durchgang und rotem Flügelgriff.

ART. NO.	DIMENSION	WVS	BOX	STATUS
52CE/1-004	1/2"	42 8120 704	24 / 96	✓
52CE/1-006	3/4"	42 8120 706	12 / 48	✓
52CE/1-008	1"	42 8120 708	9 / 36	✓



52CE/2

Kuglehane "New Compact" med fuldt gennemløb. Nippel/nippel. Rødt T-greb.

M x M "New Compact" fullway ball valve. Red butterfly handle

A x A Kugelhahn "New Compact" mit vollem Durchgang und rotem Flügelgriff.

ART. NO.	DIMENSION	WVS	BOX	STATUS
52CE/2-004	1/2"	42 8122 704	18 / 72	✓
52CE/2-006	3/4"	42 8122 706	12 / 48	✓
52CE/2-008	1"	42 8122 708	9 / 36	✓



52CE/3

Kuglehane "New Compact" med fuldt gennemløb. Muffe/forskrunding. Rødt T-greb.

"New Compact" fullway female ball valve with tail. Red butterfly handle

Kugelhahn "New Compact" mit vollem Durchgang I x A mit Verschraubung und rotem Flügelgriff.

ART. NO.	DIMENSION	WVS	BOX	STATUS
52CE/3-004	1/2" x 1/2"	42 7872 704	16 / 96	✓
52CE/3-006	3/4" x 3/4"	42 7872 706	8 / 48	✓
52CE/3-008	1" x 1"	42 7872 708	5 / 30	✓
52CE/3-010	1.1/4" x 1.1/4"	42 7872 710	4 / 24	✓



52CES

Kuglehane "New Compact" med fuldt gennemløb og følertilslutning til varmemåler, M10x1. Muffe/muffe. Rødt T-greb.

F x F "Compact" fullway ball valve and with female M10x1 connection for probe. Red butterfly handle.

I x I Kugelhahn "New Compact" mit vollem Durchgang, Sensor Anschluß, M10x1 und rotem Flügelgriff.

ART. NO.	DIMENSION	VVS	BOX	STATUS
52CES-004	1/2"	41 7936 704	20 / 80	✓
52CES-006	3/4"	41 7936 706	12 / 48	✓
52CES-008	1"	41 7636 708	7 / 28	✓



52CEST

Kuglehane "New Compact" med fuldt gennemløb og følertilslutning til varmemåler, M10x1. Muffe/muffe. Sort plastgreb.

F x F "Compact" fullway ball valve and with female M10x1 connection for probe. Black handle.

I x I Kugelhahn "New Compact" mit vollem Durchgang, Sensor Anschluß, M10x1 und

ART. NO.	DIMENSION	VVS	BOX	STATUS
52CEST-004	1/2"	41 7936 734	15 / 60	✓
52CEST-006	3/4"	41 7936 736	8 / 32	✓
52CEST-008	1"	41 7636 738	7 / 28	✓



52TEUS

Kraftig kuglehane med fuldt gennemløb og aftap. TEA overfladebehandling. Muffe/muffe. Plast T-greb med grøn markering.

F x F heavyduty fullway ball valve with drain-off, TEA treatment and black extended plastic lever.

I x I schwerer Kugelhahn mit vollem Durchgang mit Entleerungsventil, TEA Oberfläche und Kunststoffgriff.

ART. NO.	DIMENSION	VVS	BOX	STATUS
52TEUS-004	1/2"	42 7943 704	7 / 56	✓
52TEUS-006	3/4"	42 7943 706	7 / 56	✓
52TEUS-008	1"	42 7943 708	5 / 30	✓
52TEUS-010	1.1/4"	42 7943 710	6 / 12	✓



51CS

Kuglehane med fuldt gennemløb og aftap. Muffe/muffe. Rødt stålhåndtag.

F x F fullway ball valve with drain-off and red steel lever.

I x I schwerer Kugelhahn mit vollem Durchgang mit Entleerungsventil und rotem Stahlhebel.

ART. NO.	DIMENSION	VVS	BOX	STATUS
51CS-004	1/2"	42 7931 704	12 / 72	✓
51CS-006	3/4"	42 7931 706	10 / 60	✓
51CS-008	1"	42 7931 708	6 / 36	✓
51CS-010	1.1/4"	42 7931 710	5 / 20	✓
51CS-011	1.1/2"	42 7931 711	2 / 16	✓
51CS-012	2"	42 7931 712	2 / 16	✓



714COM

Aftap, forniklet til serie 51CS, 52CS, og 51EUS.

Drain off, nickel plated, for Art. series CS, TEUS and EUS.

Entleerung, vernickelt, für Art. Serien CS, TEUS und EUS.

DIMENSION	VVS	BOX	STATUS
1/4"	42 7949 702	10 / 200	✓



TB20

Termisk balance ventil til varmtvand cirkulation uden bypass. I blyfri og korrosionsbestandigt messing CW511L.

Adjustable thermal balancing valve for sanitary hot water recirculation systems.

Einstellbares thermisches Ausgleichsventil für sanitäre Warmwasser-Zirkulationssysteme.

VAREN.	DIM.	GEVIND	VVS	BOX	STATUS
TB20-004	1/2"	Muffe/Muffe		8	✓
TB20-006	3/4"	Muffe/Muffe		8	✓
TB20/2-006	3/4"	Nippel/Nippel		8	✓



TB30

Termisk balance ventil til varmtvand cirkulation, med termisk styret bypass til Legionella desinfektion. CW511L.

Adjustable thermal balancing valve for sanitary hot water recirculation systems.

Einstellbares thermisches Ausgleichsventil für sanitäre Warmwasser-Zirkulationssysteme.

VAREN.	DIM.	GEVIND	VVS	BOX	STATUS
TB30-004	1/2"	Muffe/Muffe		8	✓
TB30-006	3/4"	Muffe/Muffe		8	✓
TB30/2-006	3/4"	Nippel/Nippel		8	✓



TB50

Termisk balance ventil til varmtvand cirkulation, med termisk styret bypass. Indbygget aksial ventil til aktuator. Legionella desinfektion. CW511L.

Adjustable thermal balancing valve for sanitary hot water recirculation systems.

Einstellbares thermisches Ausgleichsventil für sanitäre Warmwasser-Zirkulationssysteme.

VAREN.	DIM.	GEVIND	VVS	BOX	STATUS
TB50-004	1/2"	Muffe/Muffe		8	✓
TB50-006	3/4"	Muffe/Muffe		8	✓
TB50/2-006	3/4"	Nippel/Nippel		8	✓



TEA



52METR

Kuglehane med omløber / muffe. TEA overfladebehandling. Rødt -greb.

Ball valve with swivel end x female. TEA treatment. Red butterfly handle.

Kugelhahn mit vollem Durchgang, Überwurfmutter x IG, TEA Oberfläche und rotem Flügelgriff.

ART. NO.	DIMENSION*	VVS	BOX	STATUS
52METR-006	3/4" x 3/4"	42 8188 706	10 / 100	✓
52METR-086	1" x 3/4"	42 8188 707	8 / 80	✓
52METR-008	1" x 1"	42 8188 708	8 / 80	✓

*Dim.: omløber x muffe / swivel end x female / Überwurfmutter x IG

TEA



52METR/1

Kuglehane med omløbermøtrik / nippel. TEA overfladebehandling. Rødt -greb.

Ball valve with swivel end x male. TEA treatment. Red butterfly handle

Kugelhahn mit vollem Durchgang, Überwurfmutter x AG, TEA Oberfläche und rotem Flügelgriff.

ART. NO.	DIMENSION*	VVS	BOX	STATUS
52METR/1-064	3/4" x 1/2"	42 8188 735	10 / 100	✓
52METR/1-006	3/4" x 3/4"	42 8188 736	10 / 100	✓
52METR/1-086	1" x 3/4"	42 8188 737	8 / 80	✓
52METR/1-008	1" x 1"	42 8188 738	8 / 80	✓

*Dim.: omløber x nippel / swivel end x male / Überwurfmutter x AG

TEA



52MET

Kuglehane med omløber / muffe. TEA overfladebehandling. Blåt -greb.

Ball valve with swivel end x female. TEA treatment. Blue butterfly handle.

Kugelhahn mit vollem Durchgang, Überwurfmutter x IG, TEA Oberfläche und blauem Flügelgriff.

ART. NO.	DIMENSION*	VVS	BOX	STATUS
52MET-006	3/4" x 3/4"	41 8188 706	10 / 100	✓
52MET-086	1" x 3/4"	41 8188 707	8 / 80	✓
52MET-008	1" x 1"	41 8188 708	8 / 80	✓

*Dim.: omløber x muffe / swivel end x female / Überwurfmutter x IG

TEA



52MET/1

Kuglehane med omløbermøtrik / nippel. TEA overfladebehandling. Blåt -greb.

Ball valve with swivel end x male. TEA treatment. Blue butterfly handle.

Kugelhahn mit vollem Durchgang, Überwurfmutter x AG, TEA Oberfläche und blauem Flügelgriff.

ART. NO.	DIMENSION*	VVS	BOX	STATUS
52MET/1-064	3/4" x 1/2"	41 8188 735	10 / 100	✓
52MET/1-006	3/4" x 3/4"	41 8188 736	10 / 100	✓
52MET/1-086	1" x 3/4"	41 8188 737	8 / 80	✓
52MET/1-008	1" x 1"	41 8188 738	8 / 80	✓

*Dim.: omløber x nippel / swivel end x male / Überwurfmutter x AG

TEA



52METV

Kuglehane med omløber / muffe. TEA overfladebehandling. Grønt -greb.

Ball valve with swivel end x female. TEA treatment. Green butterfly handle.

Kugelhahn mit vollem Durchgang, Überwurfmutter x IG, TEA Oberfläche und grünem Flügelgriff.

ART. NO.	DIMENSION*	VVS	BOX	STATUS
52METV-006	3/4" x 3/4"	41 8188 806	10 / 100	✓
52METV-086	1" x 3/4"	41 8188 807	8 / 80	✓
52METV-008	1" x 1"	41 8188 808	8 / 80	✓

*Dim.: omløber x muffe / swivel end x female / Überwurfmutter x IG

For approvals and tech. spec., see QR-code or www.pettinaroli.dk

TEA



52METV/1

Kuglehane med omløbermøtrik / nippel. TEA overfladebehandling. Grønt -greb.

Ball valve with swivel end x male. TEA treatment. Green butterfly handle.

Kugelhahn mit vollem Durchgang, Überwurfmutter x AG, TEA Oberfläche und grünem Flügelgriff.

ART. NO.	DIMENSION*	VVS	BOX	STATUS
52METV/1-064	3/4" x 1/2"	41 8188 835	10 / 100	✓
52METV/1-006	3/4" x 3/4"	41 8188 836	10 / 100	✓
52METV/1-086	1" x 3/4"	41 8188 837	8 / 80	✓
52METV/1-008	1" x 1"	41 8188 838	8 / 80	✓

*Dim.: omløber x nippel / swivel end x male / Überwurfmutter x AG

✓ in stock in Middelfart, X 2-4 weeks



209

Vinkelkuglehane med omløbermøtrik/muffe til vandmåler. TEA overfladebehandling. Rødt T-greb.

Angle ball valve with swivel end x female end for water meter. TEA treatment. Red butterfly handle.

Eckkugelhahn mit Überwurfmutter x IG für Wasserzähler. TEA Oberfläche und rotem Flügelgriff. DIN-DVGW Geprüft.

ART. NO.	DIMENSION	VVS	BOX	STATUS
209-064	3/4" X 1/2"	48 4975 704	12 / 48	✓
209-006	3/4" X 3/4"	48 4975 706	12 / 48	✓



209/1

Vinkelkuglehane med omløbermøtrik/nippel til vandmåler. TEA overfladebehandling. Rødt T-greb.

Angle ball valve with swivel end x male end for water meter. TEA treatment. Red butterfly handle.

Eckkugelhahn mit Überwurfmutter x AG für Wasserzähler. TEA Oberfläche und rotem Flügelgriff. DIN-DVGW Geprüft.

ART. NO.	DIMENSION	VVS	BOX	STATUS
209/1-064	3/4" X 1/2"	48 4976 704	8 / 80	✓
209/1-006	3/4" X 3/4"	48 4976 706	12 / 48	✓



209B

Vinkelkuglehane med omløbermøtrik/muffe til vandmåler. TEA overfladebehandling. Blåt T-greb.

Angle ball valve with swivel end x female end for water meter. TEA treatment. Blue butterfly handle.

Eckkugelhahn mit Überwurfmutter x IG für Wasserzähler. TEA Oberfläche und blauem Flügelgriff. DIN-DVGW Geprüft.

ART. NO.	DIMENSION	VVS	BOX	STATUS
209B-064	3/4" X 1/2"	48 4975 734	12 / 48	✓
209B-006	3/4" X 3/4"	48 4975 736	12 / 48	✓



209B/1

Vinkelkuglehane med omløbermøtrik/nippel til vandmåler. TEA overfladebehandling. Blåt T-greb.

Angle ball valve with swivel end x male end for water meter. TEA treatment. Blue butterfly handle.

Eckkugelhahn mit Überwurfmutter x AG für Wasserzähler. TEA Oberfläche und blauem Flügelgriff. DIN-DVGW Geprüft.

ART. NO.	DIMENSION	VVS	BOX	STATUS
209B/1-064	3/4" X 1/2"	48 4976 734	8 / 80	✓
209B/1-006	3/4" X 3/4"	48 4976 736	12 / 48	✓



296N

Kugleaftaphane med slangeforskrning. Rødt stål-greb.

Hose union ball bibcock with red steel lever.

Kugelauslaufventil mit Schlauchtülle. Roter Stahlhebel.

ART. NO.	DIMENSION	VVS	BOX	STATUS
296N-004	1/2"	74 0923 704	10 / 40	✓
296N-006	3/4"	74 0923 706	5 / 20	✓
296N-008	1"	74 0923 708	4 / 16	✓



ET-405

Minikuglehane med sort nylon greb. Hexagonal, TEA belægning, muffe/nippel.

Male/female mini ball valve with black nylon lever. Hexagonal, TEA treatment.

I x A Mini-Kugelhahn mit schwarzem Kunststoffgriff. Hexagonal, TEA Oberfläche.

ART.	DIMENSION	VVS	BOX	STATUS
ET-405-094	1/2" X 12 MM ¹⁾	74 3523 094	25	✓
ET-405-004	1/2" X 15 MM ²⁾	74 3523 004	25	✓

¹⁾ flad pakflade
²⁾ konisk pakflade



240NL

3-vejskuglehane med reduceret gennemløb (82%). L-boret. 4 pakninger.

Three way fullway ball valve. 82% fl compared to normal size. 4 seats. "L" port ball.

3-Wege Kugelhahn mit 82% Durchgang gegenüber normaler Größe. 4 Sitzen. "L" Bohrung.

ART. NO.	DIMENSION	VVS	BOX	STATUS
240NL-003	3/8"	41 8604 703	1	✓
240NL-004	1/2"	41 8604 704	1	✓
240NL-006	3/4"	41 8604 706	1	✓
240NL-008	1"	41 8604 708	1	✓
240NL-010	1.1/4"	41 8604 710	1	✓
240NL-011	1.1/2"	41 8604 711	1	✓
240NL-012	2"	41 8604 712	1	✓

For approvals and tech. spec., see QR-code or www.pettinarioli.dk



240NT

3-vejskuglehane med reduceret gennemløb (82%). T-boret. 4 pakninger.

Three way fullway ball valve. 82% fl compared to normal size. 4 seats. "T" port ball.

3-Wege Kugelhahn mit 82% Durchgang gegenüber normaler Größe. 4 Sitzen. "T" Bohrung.

ART. NO.	DIMENSION	VVS	BOX	STATUS
240NT-003	3/8"	41 8605 703	1	✓
240NT-004	1/2"	41 8605 704	1	✓
240NT-006	3/4"	41 8605 706	1	✓
240NT-008	1"	41 8605 708	1	✓
240NT-010	1.1/4"	41 8605 710	1	✓
240NT-011	1.1/2"	41 8605 711	1	✓
240NT-012	2"	41 8605 712	1	✓





59

Vinkelkuglehane med fuldt gennemløb, muffe/muffe. Rødt T-greb.

F x F heavyduty fullway angle ball valve. Red butterfly handle

IG x IG Eckkugelhahn mit vollem Durchgang und rotem Flügelgriff.

ART. NO.	DIMENSION	WVS	BOX	STATUS
59-004	1/2"	41 8184 704	16 / 64	✓
59-006	3/4"	41 8184 706	10 / 40	✓
59-008	1"	41 8184 708	8 / 32	✓



59/1

Vinkelkuglehane med fuldt gennemløb, muffe/nippel. Rødt T-greb.

F x M heavyduty fullway angle ball valve. Red butterfly handle

IG x AG Eckkugelhahn mit vollem Durchgang und rotem Flügelgriff.

ART. NO.	DIMENSION	WVS	BOX	STATUS
59/1-004	1/2"	41 8183 704	16 / 64	✓
59/1-006	3/4"	41 8183 706	10 / 40	✓
59/1-008	1"	41 8183 708	6 / 24	✓



59/2

Vinkelkuglehane med fuldt gennemløb, nippel/nippel. Rødt T-greb.

M x M heavyduty fullway angle ball valve. Red butterfly handle

AG x AG Eckkugelhahn mit vollem Durchgang und rotem Flügelgriff.

ART. NO.	DIMENSION	WVS	BOX	STATUS
59/2-004	1/2"	41 8186 704	16 / 64	✓
59/2-006	3/4"	41 8186 706	10 / 40	✓
59/2-008	1"	41 8186 708	6 / 24	✓



59/9

Vinkelkuglehane med fuldt gennemløb, nippel/muffe. Rødt T-greb.

M x F heavyduty fullway angle ball valve. Red butterfly handle

AG x IG Eckkugelhahn mit vollem Durchgang und rotem Flügelgriff.

ART. NO.	DIMENSION	WVS	BOX	STATUS
59/9-004	1/2"	41 8185 704	16 / 64	✓
59/9-006	3/4"	41 8185 706	10 / 40	✓
59/9-008	1"	41 8185 708	6 / 24	✓



51NDAV

Kuglehane med fuldt gennemløb, afzinkningsfri. Muffe/muffe. Grønt stålhåndtag.

F x F heavyduty fullway ball valve in corrosion resistant material with green steel lever.

I x I Kugelhahn mit vollem Durchgang aus korrosionsfester Legierung mit grünem Stahlhebel.

ART. NO.	DIMENSION	WVS	BOX	STATUS
51NDAV-003	3/8"	42 7916 703	12 / 120	✓
51NDAV-004	1/2"	42 7916 704	12 / 120	✓
51NDAV-006	3/4"	42 7916 706	12 / 48	✓
51NDAV-008	1"	42 7916 708	6 / 36	✓
51NDAV-010	1.1/4"	42 7916 710	4 / 24	✓
51NDAV-011	1.1/2"	42 7916 711	2 / 16	✓
51NDAV-012	2"	42 7916 712	2 / 12	✓



51CRFV



Kuglehane med fuldt gennemløb, afzinkningsfri, klemringsforskrutninger. Grønt stålhåndtag.

Fullway ball valve with compression ends. Corrosion resistant material. Green steel lever.

Kugelhahn mit vollem Durchgang aus korrosionsfester Legierung. Klemmringverschraubungen. Grüner Stahlhebel.

ART. NO.	DIMENSION	WVS	BOX	STATUS
51CRFV-012	12 (CRM)	41 8051 712	18 / 108	✓
51CRFV-015	15	41 8051 715	18 / 108	✓
51CRFV-018	18	41 8051 718	12 / 72	✓
51CRFV-022	22	41 8051 722	10 / 60	✓
51CRFV-028	28	41 8051 728	6 / 48	✓



51G



Kraftig kuglehane med fuldt gennemløb. Afzinknings- og blyfri messing CW511L. Muffe/muffe. Grønt stålhåndtag.

F x F heavyduty fullway ball valve. CW511L, dezincification and lead-free brass. Green steel handle.

I x I Schwerer Kugelhahn mit vollem Durchgang. CW511L, entzinkungs- und bleifreies Messing. Grüner Stahlgriff.

ART. NO.	DIMENSION	WVS	BOX	STATUS
51G-004	1/2"	42 7920 704	10 / 40	✓
51G-006	3/4"	42 7920 706	8 / 32	✓
51G-008	1"	42 7920 708	4 / 16	✓
51G-010	1.1/4"	42 7920 710	4 / 16	✓



51F

Kuglehane med indbygget snavssamler, mufte/muffe. Let at rengøre under tryk. Patenteret løsning i afzinkningsfri messing. Blåt stålhåndtag.

F x F ball valve with integral fil er. Special non dezincifiable alloy CW602N. Blue steel lever. Patent Pending.

IG x IG Kugelhahn mit integriertem Filter. Spezieller korrosionsfester legierung CW602 mit blauem Stahlhebel. Patentierte.

ART. NO.	DIMENSION	VVS	BOX	STATUS
51F-004	1/2"	42 0813 704	4 / 24	✓
51F-006	3/4"	42 0813 706	4 / 24	✓
51F-008	1"	42 0813 708	3 / 12	✓
51F-010	1.1/4"	42 0813 710	4 / 8	✓
51F-011	1.1/2"	42 0813 711	2 / 4	✓
51FL-012*	2" (Kv 37)	42 0813 712	2	✓
51FH-012	2" (Kv 60)	42 0812 712	2	✓

* anvend 1.1/2 filter, use 1.1/2 filter, 1.1/2" Filter verwendet



NEW

51FG

Filterkuglehane med fuldt gennemløb, CW511L, 0,1% bly. Muffe/muffe. Grønt stålhåndtag.

F x F heavyduty fullway ball valve. CW511L, dezincification and lead-free brass. Green steel handle.

I x I Schwerer Kugelhahn mit vollem Durchgang. CW511L, entzinkungs- und bleifreies Messing. Grüner Stahlgriff.

ART. NO.	DIMENSION	VVS	BOX	STATUS
51FG-004	1/2"	42 0811 704	4 / 24	✓
51FG-006	3/4"	42 0811 706	4 / 24	✓
51FG-008	1"	42 0811 708	3 / 12	✓
51FG-010	1.1/4"	42 0811 710	4 / 8	✓
51FG-011	1.1/2"	42 0811 711	2 / 4	✓
51FGL-012	2"	42 0811 712	2	✓



56F/2

Kuglehane med indbygget snavssamler, fil er af typen FM28, nippel/nippel. Automatisk rengøring af fil er under tryk. Firkanttop.

MxM ballvalve with integral fil er type FM28 easy to inspect and with automatic cleaning device.

AG x AG Kugelhahn mit integriertem rückspülbarem Filter. Automatische Reinigung des Filters unter Druck.

ART. NO.	DIMENSION	VVS	BOX	STATUS
56F/2-008	1"	42 0881 708	4 / 16	✓



FM

Filter i rustfrit stål til kuglehane Art. 51F. FM028 er standard fil er.

Stainless steel fil er for Art. 51F. FM028 is standard Filter.

Filter aus rostfreiem Stahl für Kugelhähne Art. 51F. FM028 ist Standardfilter.

ART. NO.	DIMENSION	VVS	BOX	STATUS
FM028*	Ø 700 µ (0,7 mm)			(STANDARD FILTER)
FM028N-004	1/2" - 3/4"	42 0889 715	25 / 250	✓
FM028-008	1"	42 0889 718	20 / 200	✓
FM028-010	1.1/4"	42 0889 720	15 / 150	✓
FM028-011***	1.1/2"	42 0889 721	8 / 80	✓
FM028-012	2"	42 0889 722	4 / 40	✓

Spørg til leveringstid og antal / Ask for delivery time and qty. / Fragen für Lieferzeit und Anzahl

FM040	Ø 300 µ (0,3 mm)	Enkelt/Simple
FM080	Ø 180 µ (0,18 mm)	Enkelt/Simple

FILTER BALL



- Compact design
- Quarter turn isolation ball valve
- 3 alternative stainer mesh sizes
- Corrosion resistant DZR brass
- 16 bar - 100°C / 10 bar - 150°C
- Sizes: DN15 - DN50

- Kompakt design
- Rustfri filtre med 3 orskellige maskestørrelser
- Korrosionsbestandig messing
- 16 bar - 100°C / 10 bar - 150°C
- DN15 - DN50

- Kompaktes Design
- Rostfreie Filter mit 3 verschiedenen maschengrößen
- Korrosionsfestes Messing
- 16 Bar - 100°C / 10 Bar - 150°C
- DN15 - DN50

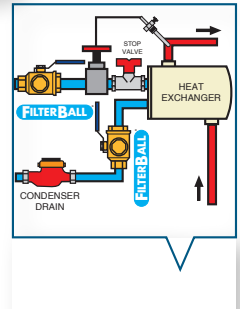
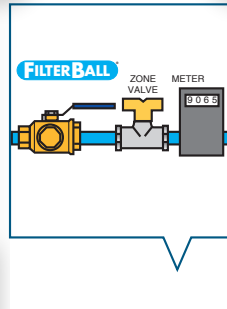
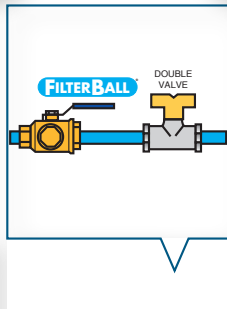
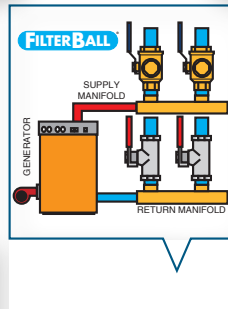
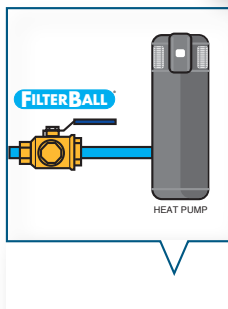
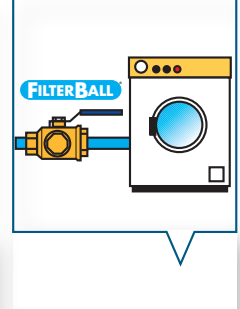
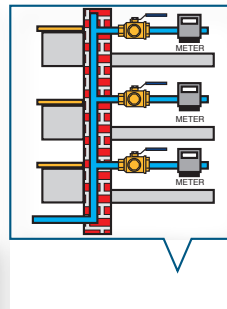
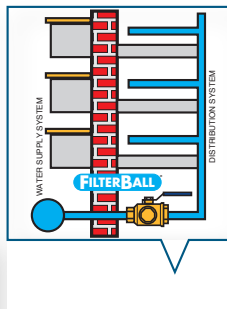
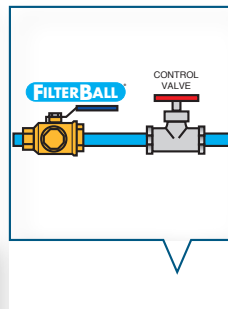
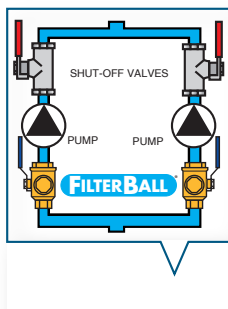



103

EvoMAGic XL magnetisk snavssamler med 360° roterende fitting. 1”N x 1”N flad ende

EvoMAGic XL magnetic dirt separator filter with 360° rotating fitting. 1”M x 1”M flat end

EvoMAGic XL magnetischer Schmutzabscheiderfilter mit 360° drehbarer Halterung. 1”M x 1”M flaches Ende.

ART. NO.	DN	PN (max)	T° (max)	Kvs	VVS	BOX	STATUS
103	25	4 bar	90°C	10	449535 008	1	✓



K103/2

EvoMAGic XL magnetisk snavssamler med 360° roterende fitting. Med 1” kuglehaner.

EvoMAGic XL magnetic dirt separator filter with 360° rotating fitting. Features: with 1” ball valves.

EvoMAGic XL magnetischer Schmutzabscheiderfilter mit 360° drehbarer Armatur. Ausstattung: mit 1” Kugelhähnen.

ART. NO.	DN	PN (max)	T° (max)	Kvs	VVS	BOX	STATUS
K103/2	25	4 bar	90°C	8	449535 108	1	✓

EvoMAGic

EvoMAGic is the compact magnetic dirt separator filters series, easy to install below the boiler, even in limited spaces.

- ✓ compact sizes to fit a y under-boiler space
- ✓ keeps the heating system efficient and in the best possible conditio
- ✓ collects all the dirt and ferrous impurities extending the life of the boiler and the dynamic valves
- ✓ quick and easy installation and maintenance procedures

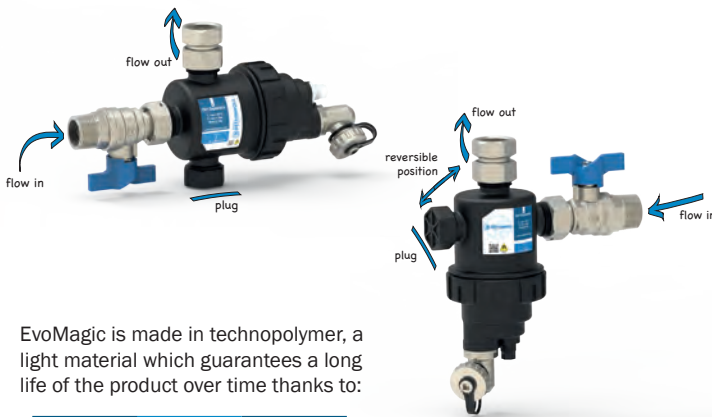

EvoMAGic is made in technopolymer, a light material which guarantees a long life of the product over time thanks to:

- high mechanical performances
- thermal resistance
- corrosion resistant properties

HIGH-PERFORMANCE WATER FILTRATION

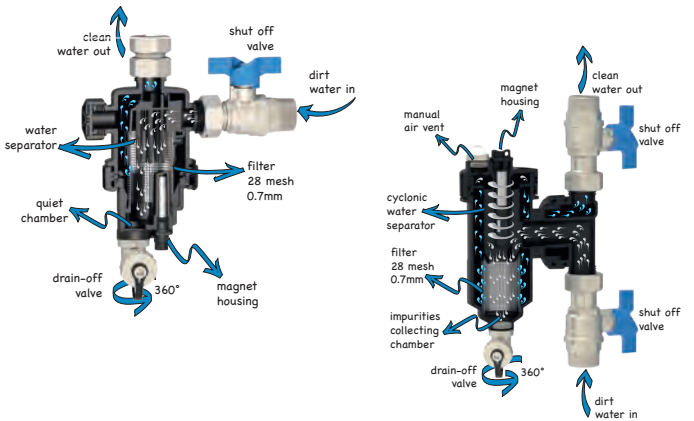

- The dirt water fi ws through the shut off valve into the body fil er
- Magnetic metallic debris are attracted by the hi-power magnets
- Other impurities are blocked by the 28 mesh (0,7 mm) fil er
- Clean water reaches the boiler ensuring its constant protection and correct operation

Scan QR-koden og læs mere om EvoMAGic: Scan the QR code and read more about EvoMAGic: Scannen Sie den QR-Code und lesen Sie mehr über EvoMAGic:



Danish



English

✓ in stock in Middelfart, X 2-4 weeks



168/O

Snavssamler i messing. Rustfrit fil er (O168B) - maskevidde 0,50.

Brass Y pattern fil er. Stainless steel strainer (O168B) - Mesh: 0,50.

Schmutzfänger, Messing. Edelstahl-Filter (O168B) - Gitter: 0,50.



170

Snavssamler i rødgods. Rustfrit fil er (1016N) - maskevidde: 3/8"-1"; 0,40 - 1.1/4"-2"; 0,50, 2.1/2"-4"; 0,80.

Bronze Y pattern fil er. Stainless steel strainer (1016N) - Mesh: 3/8"-1"; 0,40 - 1.1/4"-2"; 0,50, 2.1/2"-4"; 0,80.

Schmutzfänger, Rotgufs. Edelstahl-Filter (1016N) - Gitter: 3/8"-1"; 0,40 - 1.1/4"-2"; 0,50, 2.1/2"-4"; 0,80.

ART. NO.	DIMENSION	VVS	BOX	STATUS
168/0-003	3/8"	44 9110 003	12 / 120	✓
168/0-004	1/2"	44 9110 004	12 / 120	✓
168/0-006	3/4"	44 9110 006	10 / 100	✓
168/0-008	1"	44 9110 008	6 / 60	✓
168/0-010	1.1/4"	44 9110 010	5 / 30	✓
168/0-011	1.1/2"	44 9110 011	3 / 18	✓
168/0-012	2"	44 9110 012	2 / 12	✓

ART. NO.	DIMENSION	VVS	BOX	STATUS
170-004	1/2"	44 9115 004	10 / 100	✓
170-006	3/4"	44 9115 006	6 / 60	✓
170-008	1"	44 9115 008	5 / 50	✓
170-010	1.1/4"	44 9115 010	2 / 20	✓
170-011	1.1/2"	44 9115 011	2 / 16	✓
170-012	2"	44 9115 012	2 / 12	✓
170-013	2.1/2"	44 9115 013	2	✓
170-014	3"	44 9115 014	2	✓
170-016	4"	44 9115 016	1	✓

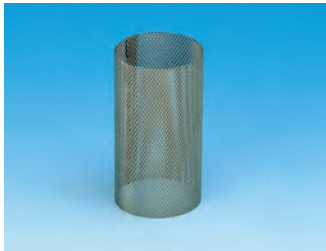

0168B

Rustfri stål filtre til snavssamlere til art. nr. 168/O

S/S strainer dimension for Y pattern fil er. For Art. no. 168/O.

Filter aus rostfreiem Stahl für Typ 168/O.

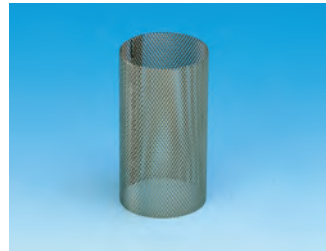

1016N

Rustfri stål filtre til snavssamlere til art. nr. 170

S/S strainer dimension for Y pattern fil er. For Art. no. 170.

Filter aus rostfreiem Stahl für Typ 170.

DIMENSION	Maskevidde (mm)	STATUS
Filter 0168B til art. nr. 168/O		
3/8" - 1/2"	0,50"	✓
3/4"	0,50"	✓
1"	0,50"	✓
1.1/4"	0,50"	✓
1.1/2"	0,50"	✓
2"	0,50"	✓

DIMENSION	Maskevidde (mm)	STATUS
Filter 1016N til art. nr. 170		
	VVS-nr.	
1/4" - 3/8" - 1/2"	44 9119 064 0,40	✓
3/4"	44 9119 066 0,40	✓
1"	44 9119 068 0,40	✓
1.1/4"	44 9119 070 0,50	✓
1.1/2"	44 9119 071 0,50	✓
2"	44 9119 072 0,50	✓
2.1/2"	44 9119 073 0,80	X
3"	44 9119 074 0,80	X
4"	44 9119 076 0,80	X



184GO

Klapkontraventil med gummiskive, messing. Kun vandret montering.

Brass swing check valve with rubber disc. Only horizontal mounting.

Klappen-Rückschlagventil mit Gummischiebe. Messing. Nur horizontale Montage.



184MO

Klapkontraventil med metalskive, messing. Kun vandret montering.

Brass swing check valve with metal disc. Only horizontal mounting.

Klappen-Rückschlagventil mit Metallschiebe. Messing. Nur horizontale Montage.



ART. NO.	DIMENSION	VVS	BOX	STATUS
184GO-004	1/2"	43 0382 704	10 / 100	✓
184GO-006	3/4"	43 0382 706	6 / 60	✓
184GO-008	1"	43 0382 708	5 / 50	✓
184GO-010	1.1/4"	43 0382 710	4 / 40	✓
184GO-011	1.1/2"	43 0382 711	3 / 24	✓
184GO-012	2"	43 0382 712	1 / 10	✓
184GO-013	2.1/2"	43 0382 713	2 / 4	X
184GO-014	3"	43 0382 714	4	X
184GO-016	4"	43 0382 716	2	X

ART. NO.	DIMENSION	VVS	BOX	STATUS
184MO-004	1/2"	43 0377 704	10 / 100	✓
184MO-006	3/4"	43 0377 706	6 / 60	✓
184MO-008	1"	43 0377 708	5 / 50	✓
184MO-010	1.1/4"	43 0377 710	4 / 40	✓
184MO-011	1.1/2"	43 0377 711	3 / 24	✓
184MO-012	2"	43 0377 712	1 / 10	✓
184MO-013	2.1/2"	43 0377 713	2 / 4	✓
184MO-014	3"	43 0377 714	4	✓
184MO-016	4"	43 0377 716	2	✓

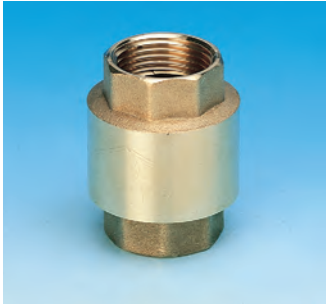

188

Kontraventil til vand, olie og trykluft. Messing. For lodret og vandret montering. Type "Glory".

Horizontal and vertical brass non return valve, "GLORY" type.

Rückschlagventil für Wasser, Öl und Druckluft. Für senkrechte und waagerechte Montage. Typ "GLORY" in Messing.

ART. NO.	DIMENSION	VVS	BOX	STATUS
188-003	3/8"	43 0335 003	16 / 160	✓
188-004	1/2"	43 0335 004	16 / 160	✓
188-006	3/4"	43 0335 006	10 / 100	✓
188-008	1"	43 0335 008	4 / 40	✓
188-010	1.1/4"	43 0335 010	2 / 20	✓
188-011	1.1/2"	43 0335 011	2 / 20	✓
188-012	2"	43 0335 012	1 / 10	✓
188-013	2.1/2"	43 0335 013	2 / 4	✓
188-014	3"	43 0335 014	4	✓
188-016	4"	43 0335 016	2	✓



1019

Bundfil er til kontraventil, Art. 188.

Stainless steel strainer for Art. 188.

Stahlfilter für Rückschlagventil Typ 188.

DIMENSION	VVS	BOX	STATUS
3/8"	43 0335 803	20	✓
1/2"	43 0335 804	20	✓
3/4"	43 0335 806	20	✓
1"	43 0335 808	50	✓
1.1/4"	43 0335 810	50	✓
1.1/2"	43 0335 811	25	✓
2"	43 0335 812	20	✓



188TEA

Kontraventil til vand, olie og trykluft. Messing med TEA belægning. For lodret og vandret montering.

Horizontal and vertical brass with TEA treatment - non return valve,

Rückschlagventil für Wasser, Öl und Druckluft. Für senkrechte und waagerechte Montage. Messing mit TEA Oberfläche

ART. NO.	DIMENSION	VVS	BOX	STATUS
188TEA-004	1/2"	43 0335 754	16 / 160	✓
188TEA-006	3/4"	43 0335 756	10 / 100	✓
188TEA-008	1"	43 0335 758	4 / 40	✓



488NDA

Kontraventil nippel x mufte, afzinkningsfri messing med TEA overfladebehandling

Non return valve, F x M made of non dezincifiable brass alloy with TEA treatment.

Rückschlagventil A x I, Korrosionsfeste Messinglegierung mit TEA Oberfläche

ART. NO.	DIMENSION	VVS	BOX	STATUS
488NDA-004	1/2"	43 0453 004	12 / 240	✓
488NDA-006	3/4"	43 0453 006	9 / 180	✓
488NDA-008	1"	43 0453 008	6 / 120	✓



188NDA

Kontraventil til vand, olie, og trykluft, afzinkningsfri messing, i h.t. BS 6282/1. Muffetilslutning til lodret/vandret mont.

Horizontal and vertical non return valve made of non dezincifiable brass alloy according to BS 6282/1.

Rückschlagventil für Wasser, Öl und Druckluft. Korrosionsfester Messinglegierung gemäß BS 6282/1. IG anschluss für senkrechte und waagerechte Mont.

ART. NO.	DIMENSION	VVS	BOX	STATUS
188NDA-004	1/2"	43 0338 004	16 / 160	✓
188NDA-006	3/4"	43 0338 006	10 / 100	✓
188NDA-008	1"	43 0338 008	6 / 60	✓
188NDA-010	1.1/4"	43 0338 010	4 / 40	✓
188NDA-011	1.1/2"	43 0338 011	4 / 40	✓
188NDA-012	2"	43 0338 012	1 / 10	✓



188CRM

Kontraventil til vand, olie, og trykluft, afzinkningsfri messing, i h.t. BS 6282/1.

Horizontal and vertical non return valve made of non dezincifiable brass alloy to BS 6282/1. Compression ends to BS 864.2.

Rückschlagventil aus korrosionsfester Messinglegierung gemäß BS 6282/1. Klemmverschraubung gemäß BS 864.2.

ART. NO.	DIMENSION	VVS	BOX	STATUS
188CRM-012	12MM	43 0461 012	20 / 200	✓
188CRM-015	15MM	43 0461 015	20 / 200	✓
188CRM-022	22MM	43 0461 022	10 / 100	✓
188CRM-028	28MM	43 0461 028	6 / 60	✓



175GLO

Skydeventil, mufte/mufte, messing.

Brass gate valve, export type.

Absperrschieber, Messing, I x I.

ART. NO.	DIMENSION	VVS	BOX	STATUS
175GLO-004	1/2"	41 0080 004	6 / 60	✓
175GLO-006	3/4"	41 0080 006	5 / 50	✓
175GLO-008	1"	41 0080 008	5 / 50	✓
175GLO-010	1.1/4"	41 0080 010	4 / 32	✓
175GLO-011	1.1/2"	41 0080 011	2 / 16	✓
175GLO-012	2"	41 0080 012	2 / 16	✓
175GLO-013	2.1/2"	41 0080 013	4	✓
175GLO-014	3"	41 0080 014	6	✓
175GLO-016	4"	41 0080 016	1	✓

For approvals and tech. spec., see QR-code or www.pettinaroli.dk

✓ in stock in Middelfart, X 2-4 weeks





696/97

Automatisk udluftningsventil. 696/97 med kontraventil (697).

Automatic air vent. 696/97 with non-return stop valve (697).

Automatischer Entlüftungsventil. 696/97 mit Absperrventil (697).

*10 bar - 115°C non shock

ART. NO.	DIMENSION	VVS	BOX	STATUS
696/97-003	3/8"	44 7082 003	1 / 50	✓
696/97-004	1/2"	44 7082 004	1 / 50	✓
696TM-003	3/8"	44 7081 003	1 / 50	✓
697-003	3/8"	44 7085 003	100	✓
697-004	1/2"	44 7085 004	100	✓



502

Trykreduktionsventil til varmt vand, max. 90°C.

Pressure reducer for hot water 90°C max.

Druckreduzierventil für Warmwasser, 90°C max.

ART. NO.	DIMENSION	VVS	BOX	STATUS
502-004	1/2"	40 6662 004	32	✓
502-006	3/4"	40 6662 006	20	✓
502-008	1"	40 6662 008	20	✓
502-010	1.1/4"	40 6662 010	10	✓
502-011	1.1/2"	40 6662 011	10	✓
502-012	2"	40 6662 012	6	✓

Max. opstrøm 20 bar, Min. nedstrøm 6 bar

Reduktionsforhold: 10:1

Max.temperatur 90°C



148SA-064

Kuglebundstophane med slutmuffe, nippel/nippel 1/2" X 3/4".

Complete boiler drain ball valve with cap. Ø1/2" M x Ø3/4" M.

KFE-Hahn mit Verschlusskappe. Ø1/2" Nippel x Ø3/4" Nippel.

ART. NO.	DIMENSION	VVS	BOX	STATUS
148SA-064	1/2" x 3/4"	40 7112 133	10 / 100	✓



148SC-415

Kuglebundstophane med slutmuffe og slangeforskrning Ø15mm, nippel/nippel 1/2" x 3/4".

Complete boiler drain ball valve with cap. Ø1/2" M x Ø3/4" M. Hose union Ø15.

KFE-Hahn mit Schlauchverschraubung und Verschlusskappe. 1/2" Nippel x 3/4" Nippel. Verschraubung Ø15mm.

ART. NO.	DIMENSION	VVS	BOX	STATUS
148SC-415	1/2" x 15	40 7116 246	10 / 100	✓



149SC-415

Kuglebundstophane med slutmuffe og slangeforskrning Ø15mm. 1/2" muffe x 3/4" nippel.

Complete boiler drain ball valve with cap. Ø3/4" F x Ø1/2" M. Hose union Ø15.

KFE-Hahn mit Verschlusskappe. Ø3/4" IG x Ø1/2" AG. Verschraubung Ø15mm.

ART. NO.	DIMENSION	VVS	BOX	STATUS
149SC-415	1/2" x 15	40 7115 244	10 / 100	✓



248SC-415

Kuglebundstophane med slutmuffe og slangeforskrning Ø15mm. Nippel x nippel 1/2" x 3/4". Sort nylongreb.

Hose union ball valve with cap. Ø1/2" M x 3/4" M. Tail Ø15mm. Black handle

KFE-Hahn Ø3/4" AG x Ø1/2" AG mit schwarzem griff.

ART. NO.	DIMENSION	VVS	BOX	STATUS
248SC-415	1/2" x 15 (MxM)	40 7124 704	10 / 100	✓



0148-006

Slutmuffe med gummipakning og PVC clips til kuglebundstophane. Til serie 148/149/248.

Cap with rubber gasket and PVC chain. For series 148/149/248.

Verschlusskappe mit Gummidichtung und PVC-Klips. Für Serie 148/149/248.

DIMENSION	VVS	BOX	STATUS
3/4" (for 148SC, 149SC, 248SC)	40 7139 806	10 / 200	✓



0148SC-615

Omløber Ø3/4" muffe. Forskrning Ø15 mm. Til serie 148/149/248.

Swivel Ø3/4" F. Hose union Ø 15 mm. For series 148/149/248.

Überwurfmutter Ø3/4" IG. Verschraubung Ø15 mm. Für Serie 148/149/248.

ART. NO.	DIMENSION	VVS	BOX	STATUS
0148SC-615	3/4" x 15	40 7129 146	10	✓



051

Rødt stålhåndtag til alle kuglehæner i serie 5X.

Steel dacromet lever with red plastic sleeve for all ball valves series 5X.

Roter Stahlhebel für alle Kugelhähne in Serie 5X.

TIPO	MM		VVS	BOX	STATUS
1	75	1/4" - 3/8" - 1/2"	41 8175 007	-	✓
2	95	3/4"	41 8175 009	-	✓
3*	120	1" - 1.1/4"	41 8175 012	-	✓
4	150	1.1/2" - 2"	41 8175 015	-	✓
5	200	2.1/2" - 3"	41 8175 020	-	✓
6	250	4"	41 8175 025	-	✓

*Serie CE 1" = TIPO 2



051TEA

Grønt stålhåndtag til alle kuglehæner i serie 5X.

Steel dacromet lever with green plastic sleeve for all ball valves series 5X.

Grüner Stahlhebel für alle Kugelhähne in Serie 5X.

TIPO	MM		VVS	BOX	STATUS
1	75	1/4" - 3/8" - 1/2"	41 8176 327	-	✓
2	95	3/4"	41 8176 329	-	✓
3	120	1" - 1.1/4"	41 8176 332	-	✓
4	150	1.1/2" - 2"	41 8176 335	-	✓
5	200	2.1/2" - 3"	41 8176 340	-	✓
6	250	4"	41 8176 346	-	✓



051BQC

Blåt stålhåndtag til alle kuglehæner i serie 5X.

Steel dacromet lever with blue plastic sleeve for all ball valves series 5X.

Blauer Stahlhebel für alle Kugelhähne in Serie 5X.

TIPO	MM		VVS	BOX	STATUS
1	75	3/8" - 1/2"	41 8176 027	-	✓
2	95	3/4"	41 8176 029	-	✓
3*	120	1" - 1.1/4"	41 8176 032	-	✓
4	150	1.1/2" - 2"	41 8176 035	-	✓
5	200	2.1/2" - 3"	41 8176 040	-	✓

*Serie CE 1" = TIPO 2



051F

Blåt stålhåndtag til Filterball.

Steel dacromet lever with blue plastic sleeve for FilterBall.

Blauer Stahlhebel für FilterBall.

TIPO	MM		VVS	BOX	STATUS
1	95	1/2" - 3/4"	41 8176 129	-	✓
2	120	1"	41 8176 132	-	✓
3	150	1.1/4" - 1.1/2"	41 8176 135	-	✓
4	200	2"	41 8176 140	-	✓



052

Rødt T-greb til alle kuglehæner i serie 5X.

Plastic coated red butterfly handle for all ball valves in series 5X.

Roter Flügelgriff für alle Kugelhähne in Serie 5X.

TIPO	MM		VVS	BOX	STATUS
1	58	1/4" - 3/8" - 1/2"	41 8177 005	-	✓
2	65	3/4"	41 8177 006	-	✓
3*	75	1" - 1.1/4"	41 8177 007	-	✓

*Serie CE 1" = TIPO 2



052V

Grønt T-greb til alle kuglehæner i serie 5X.

Plastic coated green butterfly handle for all ball valves in series 5X.

Grüner Flügelgriff für alle Kugelhähne in Serie 5X.

TIPO	MM		VVS	BOX	STATUS
1	58	1/4" - 3/8" - 1/2"	41 8177 335	-	✓
2	65	3/4"	41 8177 336	-	✓
3*	75	1" - 1.1/4"	41 8177 337	-	✓

*Serie CE 1" = TIPO 2



052B

Blåt T-greb til alle kuglehæner i serie 5X.

Plastic coated blue butterfly handle for all ball valves in series 5X.

Blauer Flügelgriff für alle Kugelhähne in Serie 5X.

TIPO	MM		VVS	BOX	STATUS
1	58	1/4" - 3/8" - 1/2"	41 8177 225	-	✓
2	65	3/4"	41 8177 226	-	✓
3*	75	1" - 1.1/4"	41 8177 227	-	✓

*Serie CE 1" = TIPO 2

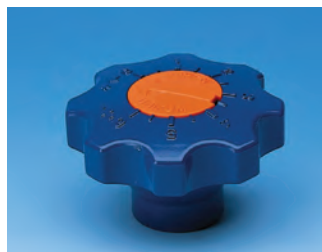

053

Gearhåndtag til alle kuglehæner i serie 5X.

Gear handle for all ball valves in series 5X.

Handrad mit Planeten-Getriebe für alle Kugelhähne in Serie 5X.

TIPO		VVS	BOX	STATUS
1	1/4" - 3/8" - 1/2"	41 8139 031	-	✓
2	3/4"	41 8139 032	-	✓
3*	1" - 1.1/4"	41 8139 033	-	✓
4	1.1/2" - 2"	41 8139 034	-	✓

*Serie CE 1" = TIPO 2

✓ in stock in Middelfart, X 2-4 weeks



1032

Messingmøtrik med korrosionsbeskyttende overflade til kuglehanehåndtag: 051 og G051.

Brass nut and steel nut special dacromet finish or levers Art. 051 and G051.

Messing Schraubenmutter für Hebel Typ 051 und G051.

TIPO	Es		WVS	BOX	STATUS
1-2	13	1/4"-3/8"-1/2"-3/4"	41 8176 082	-	✓
3	17	1" - 1.1/4"	41 8176 083	-	✓
4	21	1.1/2" - 2"	41 8176 084	-	✓
5	26	2.1/2" - 3"	41 8176 085	-	✓
6	30	4"	41 8176 086	-	✓



1031

Sekskantskrue med korrosionsbeskyttende overflade til kuglehanehåndtag: 050, 052.

Hexagonal screw dacromet finish for levers and butterfly handles Art. 050, 052, 1001 and 1003.

Schraube für Hebel und Flügelgriffe.

TIPO	MM		WVS	BOX	STATUS
1	M4	1/4"-3/8"-1/2"-3/4"	41 8176 074	-	✓
2-3	M5	1" - 1.1/4"	41 8176 075	-	✓



052TEU

Specielt langhalset T-greb til alle kuglehæner i serie 5X.

Special "Long Neck" handle for Art. 52TEU.

Besonders verlängerter Flügelgriff für Art. 52TEU.

TIPO		WVS	BOX	STATUS
1	1/2"	42 7177 035	-	✓
2	3/4"	42 7177 036	-	✓
3*	1" - 1.1/4"	42 7177 037	-	✓

*Serie CE 1" = TIPO 2



054H

Spindel forlænger til alle kuglehæner i serie 5X. Fast ydre spindel for limning af isolering.

Fixed spindle extension set for insulation. For all ball valves in series 5X.

Spindelverlängerung für alle Kugelhähne in Serie 5X.

TIPO		WVS	BOX	STATUS
1	1/4" - 3/8" - 1/2"	41 8139 121	-	✓
2	3/4"	41 8139 122	-	✓
3*	1" - 1.1/4"	41 8139 123	-	✓
4	1.1/2" - 2"	41 8139 124	-	✓
5 (054)	2.1/2" - 3"	41 8139 025	-	✓
6 (054)	4"	41 8139 026	-	✓

*Serie CE 1" = TIPO 2

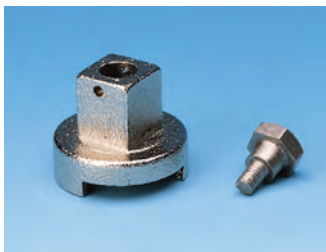

056

Spindeltop til nøgle med skrue til alle kuglehæner i serie 5X.

Lockable square head with screw for all ball valves in series 5X.

Spindeloberteil für Schlüssel mit Schraube für alle Kugelhähne in Serie 5X.

TIPO		WVS	BOX	STATUS
1	1/4" - 3/8" - 1/2"	41 8176 051	-	✓
2	3/4"	41 8176 052	-	✓
3*	1" - 1.1/4"	41 8176 053	-	✓
4	1.1/2" - 2"	41 8176 054	-	✓

*Serie CE 1" = TIPO 2



1008N

Slangeforskrumning til Art. 296N.

Nut and tail for hose union Bibcock Art. 296N. Nickel plated.

Schlauchverschraubung für Typ 296N. Vernickelt.

DIMENSION	WVS	BOX	STATUS
1/2" X 14,5	74 0938 034	-	✓
3/4" X 16,5	74 0938 736	-	X
1" X 20,0	74 0938 038	-	X



058P

Aflåselig top i åbnet eller lukket position med hukommelsstop til stålhåndtag 051.

Lockable device for open and closed position and memory stop for steel lever 051.

Verschießbares Oberteil in geöffneter und geschlossener Position mit Memorystop für Stahlhebel 051.

TIPO		WVS	BOX	STATUS
1	1/4" - 3/8" - 1/2"	41 8176 091	-	✓
2	3/4"	41 8176 092	-	✓
3*	1" - 1.1/4"	41 8176 093	-	✓
4	1.1/2" - 2"	41 8176 094	-	✓
5	2.1/2" - 3"	41 8176 095	-	✓

*Serie CE 1" = TIPO 2



0100AJ

Flange til kuglehæner serie 5X og P100, muliggør montering af ventilmotorer.

Flange for ball valve series 5X and P100, allow installation of valve engines.

Flansch für Kugelhähne Serie 5X und P100, ermöglichen Installation von Ventilmotoren

TIPO		WVS	BOX	STATUS
1	3/8" - 1/2"	41 8176 101	-	✓
2	3/4"	41 8176 102	-	✓
3	1" - 1.1/4"	41 8176 103	-	✓
4	1.1/2" - 2"	41 8176 104	-	✓

✓ in stock in Middelfart, X 2-4 weeks



G51

Gaskuglehane med fuldt gennemløb, muffe/muffe. Gult stålhåndtag.

F x F heavyduty fullway ball valve to UNI C.I.G., EN331. Yellow steel lever.

IG x IG Gaskugelhahn mit vollem Durchgang und gelbem Stahlhebel.

ART. NO.	DIMENSION	VVS	BOX	STATUS
G51-002	1/4"	41 8191 702	12 / 120	✓
G51-003	3/8"	41 8191 703	12 / 120	✓
G51-004	1/2"	41 8191 704	12 / 120	✓
G51-006	3/4"	41 8191 706	12 / 48	✓
G51-008	1"	41 8191 708	6 / 36	✓
G51-010	1.1/4"	41 8191 710	4 / 24	✓
G51-011	1.1/2"	41 8191 711	2 / 16	✓
G51-012	2"	41 8191 712	2 / 12	✓
G51-013	2.1/2"	41 8191 713	3	X
G51-014	3"	41 8191 714	2	X
G51-016	4"	41 8191 716	1	X



G51/1

Gaskuglehane med fuldt gennemløb, muffe/nippel. Gult stålhåndtag.

F x M heavyduty fullway ball valve to UNI C.I.G., EN331. Yellow steel lever.

IG x AG Gaskugelhahn mit vollem Durchgang und gelbem Stahlhebel.

ART. NO.	DIMENSION	VVS	BOX	STATUS
G51/1-002	1/4"	41 8192 702	12 / 120	✓
G51/1-003	3/8"	41 8192 703	12 / 120	✓
G51/1-004	1/2"	41 8192 704	12 / 120	✓
G51/1-006	3/4"	41 8192 706	10 / 60	✓
G51/1-008	1"	41 8192 708	6 / 36	✓
G51/1-010	1.1/4"	41 8192 710	4 / 24	✓
G51/1-011	1.1/2"	41 8192 711	2 / 12	X
G51/1-012	2"	41 8192 712	2 / 12	X



G52

Gaskuglehane med fuldt gennemløb, muffe/muffe. Gult T-greb.

F x F heavyduty fullway ball valve to UNI C.I.G., EN331. Yellow butterfly handle

IG x IG Gaskugelhahn mit vollem Durchgang und gelbem Flügelgriff.

ART. NO.	DIMENSION	VVS	BOX	STATUS
G52-002	1/4"	41 8193 702	12 / 120	✓
G52-003	3/8"	41 8193 703	12 / 120	✓
G52-004	1/2"	41 8193 704	10 / 100	✓
G52-006	3/4"	41 8193 706	6 / 60	✓
G52-008	1"	41 8193 708	4 / 40	✓
G52-010	1.1/4"	41 8193 710	2 / 20	✓

For approvals and tech. spec., see QR-code or www.pettinaroli.dk



G051

Gult stålhåndtag til alle kuglehane i serie G5X.

Steel dacromet lever with yellow plastic sleeve for all ball valves series G5X.

Gelber Stahlhebel für alle Kugelhähne in Serie G5X.

TIPO	MM	VVS	BOX	STATUS
1	75	1/4"-3/8"-1/2"	42 8189 108	✓
2	95	3/4"	42 8189 109	✓
3	120	1" - 1.1/4"	42 8189 112	✓
4	150	1.1/2" - 2"	42 8189 115	X
5	200	2.1/2" - 3"	42 8189 120	X
6	250	4"	42 8189 125	X



G052

Gult T-greb til alle kuglehane i serie G5X.

Plastic coated yellow butterfly handle for all ball valves in series G5X.

Gelber Flügelgriff für alle Kugelhähne in Serie G5X.

TIPO	MM	VVS	BOX	STATUS
1	58	1/4"-3/8"-1/2"	42 8189 305	✓
2	65	3/4"	42 8189 306	✓
3	75	1" - 1.1/4"	42 8189 307	✓



1032

Messingmøtrik med korrosionsbeskyttende overflade til kuglehanehåndtag: 051 og G051.

Brass nut and steel nut special dacromet finish or levers Art. 051 and G051.

Messing Schraubenmutter für Hebel Typ 051 und G051.

TIPO	Es	VVS	BOX	STATUS
1 - 2	13	1/4"-3/8"-1/2"-3/4"	41 8176 082	✓
3	17	1" - 1.1/4"	41 8176 083	✓
4	21	1.1/2" - 2"	41 8176 084	✓
5	26	2.1/2" - 3"	41 8176 085	✓
6	30	4"	41 8176 086	✓



1031

Sekskantskrue med korrosionsbeskyttende overflade til kuglehanehåndtag: 050, 052.

Hexagonal screw dacromet finish for levers and butterfly handles Art. 050, 052, 1001 and 1003.

Schraube für Hebel und Flügelgriffe.

TIPO	MM	VVS	BOX	STATUS
1	M4	1/4"-3/8"-1/2"-3/4"	41 8176 074	✓
2 - 3	M5	1" - 1.1/4"	41 8176 075	✓



Alpha



EC-52010-XX

Alpha trådløst gulvvarmestyring. Anvendes både som simpelt stand-alone og avanceret gulvvarmesystem via gateway og GRATIS app til SmartPhone.

Alpha wireless control system. A simple and a very advanced system in the same box.

Alpha Funksteuerung. Ein einfaches und ein sehr fortschrittliches System in der gleichen Box.

ART. NO.		VVS	BOX	STATUS
EC-52010-06	230V, 1-6 zoner	40 3582 306	1	✓
EC-52010-10	230V, 1-10 zoner	40 3582 310	1	✓

NEW



EC-52080WD

Alpha Premium digital hvid rumtermostat til Alpha trådløst styresystem, 868MHz.

Alpha Premium, wireless remote thermostat, white. 868MHz. Suitable for control system in the Alpha-series.

Alpha Premium Regler für drahtloses System, auf Systemsockel montiert, Weiß. 868MHz. Für Alpha Systeme.

ART. NO.		VVS	BOX	STATUS
EC-52080WD	Hvid/white/Weiß	40 3582 393	1	✓



A204

Energibesparende telestat, NC, 230V, 1W med klik-montering til Pettinaroli fordelersystem. Incl. Pettinaroli adaptor.

Energy saving thermo-electric actuator 1W, 230V, with adapter.

Energiesparende Stellantrieb 1W mit Klick-Montage. Für 230V Systeme. Einsch. Pettinaroli Adapter.

ART. NO.	DIMENSION	VVS	BOX	STATUS
A204	230V - 1W	40 3596 530	1	✓
VA64*	Adapter	40 3596 300	1	✓

* NC/normally closed

EC-52090WD



Digital hvid rumtermostat til Alpha trådløst styresystem, 868MHz.

Complete wireless remote thermostat, white. 868MHz. Suitable for control system in the Alpha-series.

Regler für drahtloses System, auf Systemsockel montiert, Weiß. 868MHz. Für Alpha Systeme.

ART. NO.		VVS	BOX	STATUS
EC-52090WD	Hvid/white/Weiß	40 3582 392	1	✓



EC-50001

Gateway til Alpha serien. Den sørger for, at man kan styre systemet via en GRATIS app.

Gateway. Suitable for control system in the Alpha-series. Used for control via app.

Gateway für die Alpha-Systeme. Dient für Steuerung per app.

ART. NO.		VVS	BOX	STATUS
EC-50001	Hvid/white/Weiß	40 3582 301	1	✓



NEW

EC-20001



Vejrkompenseringsanlæg med fortrådet udeføler.

Weather compensation system with pre-wired outdoor sensor.

Wetterkompensationssystem mit kabelgebundenem Außensensor.

ART. NO.		VVS	BOX	STATUS
EC-20001	Fortrådet udeføler	46 6202 830	1	✓



VAXx

Adapter til telestat. Anvendes til montage af telestat på Pettinaroli eller øvrige fabrikater af fordelersystemer.

Adapters for actuators. For mounting actuators on Pettinaroli or other manufacturers of manifolds.

Adapter. Wird zur Montage von Stellantrieben auf Pettinaroli oder andere Fabrikate von Verteilersystemen verwendet.

ART. NO.	DIM.		VVS	BOX	STATUS
VA64	M28	dark grey	Pettinaroli	40 3596 300	1 ✓
VA02	M30x1,5	grey	Uponor PRO	40 3596 342	1 ✓
VA26	Flansche	dark grey	Giacomini, PHJ, LK, Roth (<2005) Neotherm	40 3596 352	1 ✓
VA32	M28x1,5	green	Wirso (TA), Uponor	40 3596 328	1 ✓
VA50	M30x1,5	dark grey	Tesa, Frese, Honeywell, Cazzaniga, Wavin	40 3596 330	1 ✓
VA72*	Flansche	grey	Danfoss RAV/FJVR	40 3596 332	1 ✓
VA78	Flansche	white	Danfoss RA	40 3596 353	1 ✓
VA80	M30x1,5	light grey	Salus, DVI, Oventrop, Roth, Watts	40 3596 331	1 ✓



NEW

EC-20002

Vejrkompenseringsanlæg med trådløs udeføler.

Weather compensation system with wireless outdoor sensor.

Wetterkompensationssystem mit kabellosem Außensensor.

ART. NO.		VVS	BOX	STATUS
EC-20002	Trådløs udeføler	46 6202 835	1	✓

✓ in stock in Middelfart, X 2-4 weeks



**GULVVARMEPAKKER
UNDERFLOOR HEATING PACKAGES
FUßBODENHEIZUNG PAKETE**

Hurtigere køb og montering af Alpha gulvvarme.
Faster purchase and installations of Alpha underfloor heating systems.
Schnellerer Kauf und Einbau der Alpha-Fußbodenheizung

Alpha



- Ét VVS-nummer til ét system.
- En bestilling – hurtigere og nemmere.
- En kasse til ét projekt. Til én kunde.
- One number for one system
- One order - faster and easier
- One box for one project. To one customer.
- Eine Nummer für ein System
- Eine Bestellung - schneller und einfacher
- Eine Box für ein Projekt. An einen Kunden.



SKS7025

KVIKSHUNT K7025 incl. Alpha styring, Alpha Premium rumtermostater og telestater, 230V. Pakket - nemt og enkelt.

KVIKSHUNT K7025 incl. Alpha control unit, Alpha Premium room thermostat and actuators, 230V.

KVIKSHUNT K7025 incl. Alpha Funksteuerung, Alpha Premium Regler und ein Stellantrieb, 230V.



SKS

KVIKSHUNT incl. Alpha styring, digitale rumtermostater og telestater, 230V.

KVIKSUNT incl. Alpha control unit, digital room thermostat and actuators, 230V.

KVIKSHUNT incl. Alpha Funksteuerung, ein Regler und ein Stellantrieb, 230V.

ART. NO.	VVS	BOX	STATUS
SKS7025-02	2 kredse / 2 Zones / 2 Kreise	40 3582 522	1 ✓
SKS7025-03	3 kredse / 3 Zones / 3 Kreise	40 3582 523	1 ✓
SKS7025-04	4 kredse / 4 Zones / 4 Kreise	40 3582 524	1 ✓
SKS7025-05	5 kredse / 5 Zones / 5 Kreise	40 3582 525	1 ✓
SKS7025-06	6 kredse / 6 Zones / 6 Kreise	40 3582 526	1 ✓
SKS7025-07	7 kredse / 7 Zones / 7 Kreise	40 3582 527	1 ✓
SKS7025-08	8 kredse / 8 Zones / 8 Kreise	40 3582 528	1 ✓
SKS7025-09	9 kredse / 9 Zones / 9 Kreise	40 3582 529	1 ✓
SKS7025-10	10 kredse / 10 Zones / 10 Kreise	40 3582 530	1 ✓

ART. NO.	VVS	BOX	STATUS
SKS-02	2 kredse / 2 Zones / 2 Kreise	40 3582 502	1 ✓
SKS-03	3 kredse / 3 Zones / 3 Kreise	40 3582 503	1 ✓
SKS-04	4 kredse / 4 Zones / 4 Kreise	40 3582 504	1 ✓
SKS-05	5 kredse / 5 Zones / 5 Kreise	40 3582 505	1 ✓
SKS-06	6 kredse / 6 Zones / 6 Kreise	40 3582 506	1 ✓
SKS-07	7 kredse / 7 Zones / 7 Kreise	40 3582 507	1 ✓
SKS-08	8 kredse / 8 Zones / 8 Kreise	40 3582 508	1 ✓
SKS-09	9 kredse / 9 Zones / 9 Kreise	40 3582 509	1 ✓
SKS-10	10 kredse / 10 Zones / 10 Kreise	40 3582 510	1 ✓



PPS

Pakkeløsning: Alpha gulvvarmestyring, Alpha Premium rumtermostater og telestater, 230V. Pakket - nemt og enkelt.

Package: Alpha control unit, Alpha Premium room thermostats and actuators, 230V. Packed - easy and simple.

Paketlösung: Alpha Fußbodenheizungssteuerung, Alpha Premium Raumthermostate und Telestater, 230V. Verpackt - einfach und unkompliziert.



PS

Pakkeløsning: Alpha gulvvarmestyring, rumtermostater og telestater, 230V. Pakket - nemt og enkelt.

Package: Alpha underfloor heating control, room thermostats and actuators, 230V. Packed - easy and simple.

Paketlösung: Alpha Fußbodenheizungssteuerung, Raumthermostate und Telestater, 230V. Verpackt - einfach und unkompliziert.

ART. NO.	VVS	BOX	STATUS
PPS-02	2 kredse / 2 Zones / 2 Kreise	40 3582 622	1 ✓
PPS-03	3 kredse / 3 Zones / 3 Kreise	40 3582 623	1 ✓
PPS-04	4 kredse / 4 Zones / 4 Kreise	40 3582 624	1 ✓
PPS-05	5 kredse / 5 Zones / 5 Kreise	40 3582 625	1 ✓
PPS-06	6 kredse / 6 Zones / 6 Kreise	40 3582 626	1 ✓
PPS-07	7 kredse / 7 Zones / 7 Kreise	40 3582 627	1 ✓
PPS-08	8 kredse / 8 Zones / 8 Kreise	40 3582 628	1 ✓
PPS-09	9 kredse / 9 Zones / 9 Kreise	40 3582 629	1 ✓
PPS-10	10 kredse / 10 Zones / 10 Kreise	40 3582 630	1 ✓

ART. NO.	VVS	BOX	STATUS
PS-02	2 kredse / 2 Zones / 2 Kreise	40 3582 602	1 ✓
PS-03	3 kredse / 3 Zones / 3 Kreise	40 3582 603	1 ✓
PS-04	4 kredse / 4 Zones / 4 Kreise	40 3582 604	1 ✓
PS-05	5 kredse / 5 Zones / 5 Kreise	40 3582 605	1 ✓
PS-06	6 kredse / 6 Zones / 6 Kreise	40 3582 606	1 ✓
PS-07	7 kredse / 7 Zones / 7 Kreise	40 3582 607	1 ✓
PS-08	8 kredse / 8 Zones / 8 Kreise	40 3582 608	1 ✓
PS-09	9 kredse / 9 Zones / 9 Kreise	40 3582 609	1 ✓
PS-10	10 kredse / 10 Zones / 10 Kreise	40 3582 610	1 ✓



PPSMP

Alpha gulvvarmestyring, Premium rumtermostater og telestater, 230V. Pakket - Monteret - Programmeret.

Alpha underfloor heating control unit, Premium room thermostats and actuators, 230V. Packed - Assembled - Programmed.

Alpha Fußbodenheizungssteuerung, Premium Raumthermostate und Telestater, 230V. Verpackt - zusammengebaut - programmiert.



PSMP

Alpha gulvvarmestyring, rumtermostater og telestater, 230V. Pakket - Monteret - Programmeret.

Alpha underfloor heating control unit, room thermostats and actuators, 230V. Packed - Assembled - Programmed.

Alpha Fußbodenheizungssteuerung, Raumthermostate und Telestater, 230V. Verpackt - zusammengebaut - programmiert.

ART. NO.	VVS	BOX	STATUS
PPSMP-02	2 kredse / 2 Zones / 2 Kreise	40 3582 642	1 ✓
PPSMP-03	3 kredse / 3 Zones / 3 Kreise	40 3582 643	1 ✓
PPSMP-04	4 kredse / 4 Zones / 4 Kreise	40 3582 644	1 ✓
PPSMP-05	5 kredse / 5 Zones / 5 Kreise	40 3582 645	1 ✓
PPSMP-06	6 kredse / 6 Zones / 6 Kreise	40 3582 646	1 ✓
PPSMP-07	7 kredse / 7 Zones / 7 Kreise	40 3582 647	1 ✓
PPSMP-08	8 kredse / 8 Zones / 8 Kreise	40 3582 648	1 ✓
PPSMP-09	9 kredse / 9 Zones / 9 Kreise	40 3582 649	1 ✓
PPSMP-10	10 kredse / 10 Zones / 10 Kreise	40 3582 650	1 ✓

ART. NO.	VVS	BOX	STATUS
PSMP-02	2 kredse / 2 Zones / 2 Kreise	40 3582 702	1 ✓
PSMP-03	3 kredse / 3 Zones / 3 Kreise	40 3582 703	1 ✓
PSMP-04	4 kredse / 4 Zones / 4 Kreise	40 3582 704	1 ✓
PSMP-05	5 kredse / 5 Zones / 5 Kreise	40 3582 705	1 ✓
PSMP-06	6 kredse / 6 Zones / 6 Kreise	40 3582 706	1 ✓
PSMP-07	7 kredse / 7 Zones / 7 Kreise	40 3582 707	1 ✓
PSMP-08	8 kredse / 8 Zones / 8 Kreise	40 3582 708	1 ✓
PSMP-09	9 kredse / 9 Zones / 9 Kreise	40 3582 709	1 ✓
PSMP-10	10 kredse / 10 Zones / 10 Kreise	40 3582 710	1 ✓



SK20UPM-1

MINISHUNT til én kreds. Incl. UPM2 15/20 pumpe og 20 mm PEX fittings. Max. 35m².

MINISHUNT with one outlet. Incl. UPM2 15/20 pump and 20 mm PEX fittings. Max. 35m².

MINISHUNT mit eine Entleerung. Incl. UPM2 15/20 Pumpe und 20 mm PEX Fittings. Max. 35m².

ART. NO.	DIMENSION	VVS	BOX	STATUS
SK20UPM-1	1/2"	04 6879 121	1	✓



JV-001

Multiboks til regulering af gulvvarme og kombinerede gulvvarme-/radiatoranlæg. Max. 8 m².

Multi-box for regulating underfloor heating and combined underfloor heating / radiator systems. Max. 8 m².

Multi-Box zur Regelung von Fußbodenheizungen und kombinierten Fußbodenheizungs- / Heizkörpersystemen. Max. 8 m².

ART. NO.	DIMENSION	VVS	BOX	STATUS
JV-001	G 3/4"	40 3568 006	1	✓

NEW



JV-002F

Multiboks incl. fortrådet styring og telestat. 230V. Max. 8 m².

Multi-box incl. wired control unit and actuator. 230V. Max. 8 m².

Multi-Box incl. verdrahtetes Regelung und Stellantrieb. 230V. Max. 8 m².

ART. NO.	DIMENSION	VVS	BOX	STATUS
JV-002F	G 3/4"	04 3568 106	1	✓

NEW



JV-002D

Multiboks incl. trådløs styring, digital rumtermostat og telestat. 230V. Max. 8 m².

Multi-box incl. wireless control unit, room thermostat and actuator. 230V. Max. 8m².

Multi-Box incl. drahtloses Regelung, Raum Thermostat und Stellantrieb. 230V. Max. 8m².

ART. NO.	DIMENSION	VVS	BOX	STATUS
JV-001	G 3/4"	40 3568 206	1	✓



A220102-01KA

PAKKELØSNING: 1-kanal trådløst gulvvarmestyringsystem, incl. styring, telestat og analog rumtermostat. *Digital rumtermostat. Telestat ledningsført, rumtermostat indkodet. UD AF ÆSKEN - OP PÅ VÆGGEN.

Wireless underfloor heating system for 1 zone, incl. control unit, actuator and room thermostat. *

Drahtloses System für 1 Zone.

ART. NO.	DIMENSION	VVS	BOX	STATUS
A220102-01KA	230V - 868MHz	46 6209 730	1	✓

*A220102-01K	230V - 868MHz	40 3582 701	1	✓
--------------	---------------	-------------	---	---

*Digital rumtermostat / Digital room thermostat / Digitaler Raumthermostat



A220102-01KADPR

PAKKELØSNING: 1-kanal trådløst gulvvarmestyringsystem, incl. styring, telestat, analog rumtermostat og radiatorventil. Telestat ledningsført, rumtermostat indkodet. UD AF ÆSKEN - OP PÅ VÆGGEN.

Wireless underfloor heating system for 1 zone, incl. control unit, actuator, room thermostat and radiator valve.

Drahtloses System für 1 Zone.

ART. NO.	DIMENSION	VVS	BOX	STATUS
A220102-01KADPR	230V - 868MHz	46 6209 801	1	✓



EC-32090-KA

PAKKELØSNING: 1-kanal fortrådet gulvvarmestyring, incl. telestat, analog eller *digital rumtermostat.

Wired underfloor heating system for 1 zone, incl. actuator and room thermostat. *Digital Room Thermostat.

Verdrahtetes System für 1 Zone. *Digitaler Raumthermostat.

ART. NO.	DIMENSION	VVS	BOX	STATUS
EC-32090-KA	230V - 868MHz	46 6209 740	1	✓

*EC-32090-KD	230V - 868MHz	46 6209 745	1	✓
--------------	---------------	-------------	---	---



EC-32090-K

PAKKELØSNING: 1-kanal fortrådet gulvvarmestyring, incl. telestat, analog rumtermostat og 1/2" ventil.

Wired underfloor heating system for 1 zone, incl. actuator, analog room thermostat and 1/2" valve.

Verdrahtetes System für 1 Zone und 1/2" Ventile.

ART. NO.	DIMENSION	VVS	BOX	STATUS
EC-32090-K	230V - 868MHz	46 6209 708	1	✓

✓ in stock in Middelfart, X 2-4 weeks



DIRECT • 24V / 230V



EC-34010-XX

Fortrådet gulvvarmestyringsystem "DIRECT" til 6 og 10 zoner, incl. pumpe/stop relæ, 24V.

Wired control unit "DIRECT" for 6 og 10 zones, 24V

Verdrahtetes System "DIRECT" für 6 og 10 Zonen, 24V.

ART. NO.	DIMENSION	VVS	BOX	STATUS
EC-34010-06	6 zoner	40 3597 601	1	✓
EC-34010-10	10 zoner	40 3597 602	1	✓



EC-34090D

Digital og analog rumtermostat til fortrådet gulvvarmesystem. Passer til DIRECT-serien, 24V.

Complete wired thermostat. Suitable for the DIRECT-series, 24V.

Regler für verdrahtetes System. Für DIRECT Systeme, 24V.

ART. NO.	VERSION	VVS	BOX	STATUS
EC-34090D	Digital	40 3598 611	1	✓
EC-34090	Analog	40 3598 610	1	✓



A404

Energibesparende telestat 24V, 1W med klik-montering til Pettinaroli fordelersystem. Incl. Pettinaroli adaptor.

Energy saving thermo-electric actuator 1W, 24V, with adapter.

Energiesparende Stellantrieb 1W mit Klick-Montage. Für 24V Systeme. Einsch. Pettinaroli Adapter.

ART. NO.	DIMENSION	VVS	BOX	STATUS
A404*	24V - 1W	40 3596 524	1	✓

* NC/normally closed



EC-32010-XX

Fortrådet gulvvarmestyringsystem "DIRECT" til 6 og 10 zoner, incl. pumpe/stop relæ, 230V.

Wired control unit "DIRECT" for 6 og 10 zones, 230V

Verdrahtetes System "DIRECT" für 6 og 10 Zonen, 230V.

ART. NO.	DIMENSION	VVS	BOX	STATUS
EC-32010-06	6 zoner	40 3599 606	1	X
EC-32010-10	10 zoner	40 3599 610	1	X



EC-32090D

Digital og analog rumtermostat til fortrådet gulvvarmesystem. Passer til DIRECT-serien, 230V.

Complete wired thermostat. Suitable for the DIRECT-series, 230V.

Regler für verdrahtetes System. Für DIRECT Systeme, 230V.

ART. NO.	VERSION	VVS	BOX	STATUS
EC-32090D	Digital	40 3599 611	1	✓
EC-32090	Analog	40 3594 210	1	✓



A204

Energibesparende telestat, NC, 230V, 1W med klik-montering til Pettinaroli fordelersystem. Incl. Pettinaroli adaptor.

Energy saving thermo-electric actuator 1W, 230V, with adapter.

Energiesparende Stellantrieb 1W mit Klick-Montage. Für 230V Systeme. Einsch. Pettinaroli Adapter.

ART. NO.	DIMENSION	VVS	BOX	STATUS
A204*	230V - 1W	40 3596 530	1	✓

* NC/normally closed

✓ in stock in Middelfart, X 2-4 weeks

Styresystemer til gulvvarme. Udgået af sortiment.

(Tilgængelige rumtermostater)

<i>Alpha/Bravo styresystemer</i>		<i>Alpha/Bravo rumtermostater</i>		<i>Tilgængelig rumtermostat</i>	
	AB4071-06 AB4071-12 (868MHz)		AR4070SF AR4070KF2E (m/gulvføler)		R4070 40 3597 920
	B2070-02 B2070-06 B2070-12 (868MHz)		R4070 R4070E (m/gulvføler)		ODR4070H 40 3597 880
<i>COMFORT styresystemer</i>		<i>COMFORT rumtermostater</i>		<i>Tilgængelige rumtermostater</i>	
	A240112-04 A240112-08 A240112-12		A264202		A264202 40 3582 800
	A240112NW-04 A240112NW-08 A240112NW-12		A264202D		A264202D 40 3582 810
<i>COMFORT IP styresystemer</i>		<i>COMFORT IP rumtermostater</i>		<i>Tilgængelige rumtermostater</i>	
	EC-42010-06 EC-42010-10		EC-42090		EC-40090 40 3582 450
			EC-42090D		
			EC-42090WD		



NEW BRACKETS K7025



KVIKSHUNT: Komplet gulvvarmesystem 2-12 kredse, UPM3 pumpe, 3/4" fordelerrør, 20 mm PEX fittings, u/forindstilling. **NYT forbedret beslag for isolering.**

KVIKSHUNT: Complete underfl or heating system 2-12 outlets. UPM3 pump, 3/4" manifold, 20 mm PEX fittings, without pre-setting. **NEW brackets for insulation.**

KVIKSHUNT

ART. NO.	DIMENSION*	WVS	BOX	STATUS
K7025-02	3/4"	04 6878 202	1	✓
K7025-03	3/4"	04 6878 203	1	✓
K7025-04	3/4"	04 6878 204	1	✓
K7025-05	3/4"	04 6878 205	1	✓
K7025-06	3/4"	04 6878 206	1	✓
K7025-07	3/4"	04 6878 207	1	✓
K7025-08	3/4"	04 6878 208	1	✓
K7025-09	3/4"	04 6878 209	1	✓
K7025-10	3/4"	04 6878 210	1	✓
K7025-11	3/4"	04 6878 211	1	✓
K7025-12	3/4"	04 6878 212	1	✓

NEW 7025SYS20



3/4" komplet fordelersystem incl. 20mm fittings og 2 stk. endestykker. 1" tilslutning. **Med forindstilling**

Complete manifold system, in- and outlet, incl. brackets, fittings and end pieces. 1" connection. **With pre-setting.**

Komplettes Verteilersystem. Mit Wandhalterungen, Fittings und Abschlußstücke. 1" Verbindung. Mit Voreinstellung.

ART. NO.	DIMENSION*	WVS	BOX	STATUS
7025SYS20-02	3/4" x 3/4" / 2	04 6878 402	1	✓
7025SYS20-03	3/4" x 3/4" / 3	04 6878 403	1	✓
7025SYS20-04	3/4" x 3/4" / 4	04 6878 404	1	✓
7025SYS20-05	3/4" x 3/4" / 5	04 6878 405	1	✓
7025SYS20-06	3/4" x 3/4" / 6	04 6878 406	1	✓
7025SYS20-07	3/4" x 3/4" / 7	04 6878 407	1	✓
7025SYS20-08	3/4" x 3/4" / 8	04 6878 408	1	✓
7025SYS20-09	3/4" x 3/4" / 9	04 6878 409	1	✓
7025SYS20-10	3/4" x 3/4" / 10	04 6878 410	1	✓
7025SYS20-11	3/4" x 3/4" / 11	04 6878 411	1	✓
7025SYS20-12	3/4" x 3/4" / 12	04 6878 412	1	✓

NEW 7025



Kompakt paralleleshunt med ligeløbende tilslutningssæt, selvvirkende termostat og integreret kontraventil mellem til- og afgang. Incl. UPM3 pumpe. Max. 250 m²*

Complete mixing kit with circulating pump, thermostatic valve with remote sensor, integrated non return valve*.

Kompletter Mischer mit UPM3 Pumpe. Anschluß, selbstwirkendem Thermostat und integrierte Rückschlagventil*.

ART. NO.	WVS	BOX	STATUS
7025	04 6878 808	1	✓

*Passer til 3/4" 7025 serien / For 3/4" 7025 Serie / Für 3/4" 7025 Serie.

NEW IS7025



Isolering til KVIKSHUNT, shunt* og 3/4" manifold**. EPP (Ekspanderet polypropylen). Til serie 7025.

Insulation for KVIKSHUNT, shunt* and 3/4" manifold**. For series 7025.

Isolierung für KVIKSHUNT, shunt* und 3/4" Fußboden Verteiler**. Typ 7025.

ART. NO.	WVS	BOX	STATUS
IS7025	Insulation for complete KVIKSHUNT	04 6868 908	1 ✓
IS7025*	Insulation for SHUNT (only)	04 6878 888	1 ✓
IS7025**	Insulation for 3/4" for manifold/8 outlets	04 6878 908	1 ✓

3/4" 7035TEM-006



3/4" præsamlet fordelerrør med integreret ventil, returløb. Uden fitting

Pre-assembled linear manifold with micrometric manoeuvre, with thermostatic option or electrical control, for return pipes. Compression ends. Without fittings

Vorgefertigte linienförmige Verteiler mit Mikrometer Regelung. Für Thermostat oder elektrischen Stellantrieb für Rücklaufrohr. Klemmverschraubung.

ART. NO.	DIMENSION	WVS	BOX	STATUS
7035TEM-006-02	3/4" x 3/4"/2	04 6881 202	2	✓
7035TEM-006-03	3/4" x 3/4"/3	04 6881 203	2	✓
7035TEM-006-04	3/4" x 3/4"/4	04 6881 204	2	✓
7035TEM-006-05	3/4" x 3/4"/5	04 6881 205	2	✓
7035TEM-006-06	3/4" x 3/4"/6	04 6881 206	2	✓
7035TEM-006-07	3/4" x 3/4"/7	04 6881 207	1	✓
7035TEM-006-08	3/4" x 3/4"/8	04 6881 208	1	✓

3/4" 7035M-006



3/4" præsamlet fordelerrør, fremløb. Uden fittings

3/4" pre-assembled linear manifold. Without fittings. ellow.

3/4" vorgefertigte linienförmige Verteiler. Ohne fittings.

ART. NO.	DIMENSION	WVS	BOX	STATUS
7035M-006-02	3/4" x 3/4"/2	04 6880 202	2	✓
7035M-006-03	3/4" x 3/4"/3	04 6880 203	2	✓
7035M-006-04	3/4" x 3/4"/4	04 6880 204	2	✓
7035M-006-05	3/4" x 3/4"/5	04 6880 205	2	✓
7035M-006-06	3/4" x 3/4"/6	04 6880 206	2	✓
7035M-006-07	3/4" x 3/4"/7	04 6880 207	1	✓
7035M-006-08	3/4" x 3/4"/8	04 6880 208	1	✓

✓ in stock in Middelfart, X 2-4 weeks



7021

Kompakt parallelshunt med ligeløbende tilslutningssæt, selvvirkende termostat og integreret kontraventil mellem til- og afgang. Incl. UPM3 pumpe. Max. 250 m²*

Complete mixing kit with circulating pump, thermostatic valve with remote sensor, integrated non return valve.*

*Kompletter Mischer mit UPM3 Pumpe. Anschluß, selbstwirkendem Thermostat und integrierte Rückschlagventil.**

ART. NO.	VVS	BOX	STATUS
7021	46 6202 780	1	✓

*Passer til 1" 7035 serien / For 1" 7035 Serie / Für 1" 7035 Serie.



7035SYS20

1" komplet fordelersystem incl. 20mm fittings og 2 stk. endestykker.

Complete manifold system, in- and outlet, incl. brackets, fittings and end pieces

Komplettes Verteilersystem. Einschl. Wandhalterungen, Fittings und Abschlußstücke.

ART. NO.	DIMENSION	VVS	BOX	STATUS
7035SYS20-02	1" x 3/4"/2	04 6868 202	1	✓
7035SYS20-03	1" x 3/4"/3	04 6868 203	1	✓
7035SYS20-04	1" x 3/4"/4	04 6868 204	1	✓
7035SYS20-05	1" x 3/4"/5	04 6868 205	1	✓
7035SYS20-06	1" x 3/4"/6	04 6868 206	1	✓
7035SYS20-07	1" x 3/4"/7	04 6868 207	1	✓
7035SYS20-08	1" x 3/4"/8	04 6868 208	1	✓
7035SYS20-09	1" x 3/4"/9	04 6868 209	1	✓
7035SYS20-10	1" x 3/4"/10	04 6868 210	1	✓
7035SYS20-11	1" x 3/4"/11	04 6868 211	1	✓
7035SYS20-12	1" x 3/4"/12	04 6868 212	1	✓



7035TDM

Fordelesystem frem- og returløb monteret på vægbeslag. Uden fittings

Pre-assembled manifold for panel plants. Incl. supply and return bar, brackets. Without fittings

Vorgefertigte Fertigverteiler für Anlagen. Bestehend aus: Vor- und Rücklauf, Wandhalterungen. Ohne Fittings.

ART. NO.	DIMENSION	VVS	BOX	STATUS
7035TDM-008-02	1" x 3/4"/2	04 6867 202	2	✓
7035TDM-008-03	1" x 3/4"/3	04 6867 203	1	✓
7035TDM-008-04	1" x 3/4"/4	04 6867 204	1	✓
7035TDM-008-05	1" x 3/4"/5	04 6867 205	1	✓
7035TDM-008-06	1" x 3/4"/6	04 6867 206	1	✓
7035TDM-008-07	1" x 3/4"/7	04 6867 207	1	✓
7035TDM-008-08	1" x 3/4"/8	04 6867 208	1	✓
7035TDM-008-09	1" x 3/4"/9	04 6867 209	1	✓
7035TDM-008-10	1" x 3/4"/10	04 6867 210	1	✓
7035TDM-008-11	1" x 3/4"/11	04 6867 211	1	✓
7035TDM-008-12	1" x 3/4"/12	04 6867 212	1	✓

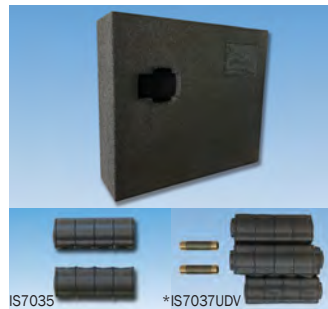

IS7035/IS7037

Isoleringsboks til 3/4" og 1" gulvvarme-manifold. Fordelesystem 2 til 5 kredse.

Insulation box for 3/4" and 1" underfloor heating systems. Manifold system 2 to 5 outlets.

Isolierung für 3/4" und 1" Fußboden Verteiler. Verteilersystem von 2 bis 5 Kreisen.

* 3/4" isoleringssæt - 3/4" Insulation set - 3/4" Isolierung Set

ART. NO.	DIMENSION	VVS	BOX	STATUS
IS7037 - 3/4" and 1"	2-5 outlets	04 6868 920	1	✓
IS7035 - 1"	4 outlets	04 6868 911	1	✓
IS7037UDV-3	add up to 3 outlets	04 6868 903	1	✓
IS7037UDV-7	add up to 7 outlets	04 6868 907	1	✓



3/4" K7037N-006

Udvidelsessæt til midishunt, 2 kredse. 3/4" fordeler frem og retur, samt nippelstykker. Incl. 20/16 fittings

Extension to midishunt, 2 circuits. 3/4" manifold, supply and return bar, incl. coupling. Incl. 20/16 fittings

Erweiterung auf midishunt, 2 Kreise. 3/4" Verteiler, Vor- und Rücklauf. Incl. Kupplung. Incl. 20/16 fittings.

ART. NO.	DIMENSION	VVS	BOX	STATUS
K7037N-006	3/4"	04 6879 902	1	✓



1" K7035N-008

Udvidelsessæt til 1" fordelerrørssæt, 2 kredse. Frem og retur fordeler, samt nippelstykker. Incl. 20/16 fittings

Extension to 1" manifold, 2 circuits. 1" manifold, supply and return bar, incl. coupling. Incl. 20/16 fittings

Erweiterung auf 1" Verteiler, 2 Kreise. 1" Verteiler, Vor- und Rücklauf. Incl. Kupplung. Incl. 20/16 fittings.

ART. NO.	DIMENSION	VVS	BOX	STATUS
K7035N-008	1"	04 6879 908	1	✓

✓ in stock in Middelfart, X 2-4 weeks



7035TEM-008

Præsamlert fordelerrør med integreret ventil, returløb. Uden fitting

Pre-assembled linear manifold with micrometric manoeuvre, with thermostatic option or electrical control, for return pipes. Compression ends. Without fittings

Vorgefertigte linienförmige Verteiler mit Mikrometer Regelung. Für Thermostat oder elektrischen Stellantrieb für Rücklaufrohr. Klemmverschraubung.

ART. NO.	DIMENSION	VVS	BOX	STATUS
7035TEM-008-02	1" x 3/4"/2	04 6865 202	2	✓
7035TEM-008-03	1" x 3/4"/3	04 6865 203	2	✓
7035TEM-008-04	1" x 3/4"/4	04 6865 204	2	✓
7035TEM-008-05	1" x 3/4"/5	04 6865 205	2	✓
7035TEM-008-06	1" x 3/4"/6	04 6865 206	2	✓
7035TEM-008-07	1" x 3/4"/7	04 6865 207	1	✓
7035TEM-008-08	1" x 3/4"/8	04 6865 208	1	✓
7035TEM-008-09	1" x 3/4"/9	04 6865 209	1	✓
7035TEM-008-10	1" x 3/4"/10	04 6865 210	1	✓
7035TEM-008-11	1" x 3/4"/11	04 6865 211	1	✓
7035TEM-008-12	1" x 3/4"/12	04 6865 212	1	✓

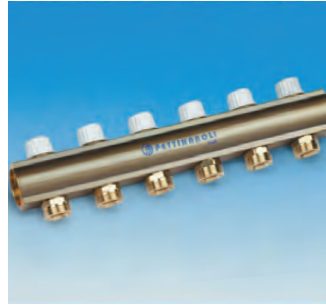

7035DM-008

Præsamlert fordelerrør med integreret ventil, fremløb. Uden fitting

Pre-assembled linear manifold with incorporated lockshield valve. Micrometric regulation. Compression ends. Without fittings. allow.

Vorgefertigte linienförmige Verteiler mit integrierter Freimachungsvorrichtung. Für Thermostat oder elektrischen Stellantrieb. Mikrometer Regelung.

ART. NO.	DIMENSION	VVS	BOX	STATUS
7035DM-008-02	1" x 3/4"/2	04 6863 202	2	✓
7035DM-008-03	1" x 3/4"/3	04 6863 203	2	✓
7035DM-008-04	1" x 3/4"/4	04 6863 204	2	✓
7035DM-008-05	1" x 3/4"/5	04 6863 205	2	✓
7035DM-008-06	1" x 3/4"/6	04 6863 206	2	✓
7035DM-008-07	1" x 3/4"/7	04 6863 207	1	✓
7035DM-008-08	1" x 3/4"/8	04 6863 208	1	✓
7035DM-008-09	1" x 3/4"/9	04 6863 209	1	✓
7035DM-008-10	1" x 3/4"/10	04 6863 210	1	✓
7035DM-008-11	1" x 3/4"/11	04 6863 211	1	✓
7035DM-008-12	1" x 3/4"/12	04 6863 212	1	✓



7000PM

Linjær messing fordeler.

Drawn brass bar linear manifold. Yellow.

Linienförmiger Messing Fertigverteiler.

ART. NO.	DIMENSION	VVS	BOX	STATUS
7000PM-064-02	3/4" x 1/2"/2	04 6870 132	10	✓
7000PM-064-03	3/4" x 1/2"/3	04 6870 133	10	✓
7000PM-064-04	3/4" x 1/2"/4	04 6870 134	10	✓
7000PM-064-05	3/4" x 1/2"/5	04 6870 135	10	✓
7000PM-064-06	3/4" x 1/2"/6	04 6870 136	10	✓
7000PM-064-07	3/4" x 1/2"/7	04 6870 137	10	✓
7000PM-064-08	3/4" x 1/2"/8	04 6870 138	10	✓

ART. NO.	DIMENSION	VVS	BOX	STATUS
7000PM-084-02	1" x 1/2"/2	04 6870 232	8	X
7000PM-084-03	1" x 1/2"/3	04 6870 233	8	X
7000PM-084-04	1" x 1/2"/4	04 6870 234	8	X
7000PM-084-05	1" x 1/2"/5	04 6870 235	8	X
7000PM-084-06	1" x 1/2"/6	04 6870 236	8	X
7000PM-084-07	1" x 1/2"/7	04 6870 237	8	X
7000PM-084-08	1" x 1/2"/8	04 6870 238	8	X
7000PM-084-09	1" x 1/2"/9	04 6870 239	8	X
7000PM-084-10	1" x 1/2"/10	04 6870 240	8	X
7000PM-084-11	1" x 1/2"/11	04 6870 241	8	X
7000PM-084-12	1" x 1/2"/12	04 6870 242	8	X



7021SS

Kompakt parallelshunt til rustfri stål topmetermanifold type 7035TOP20. Med tilslutningssæt, selvvirkende thermostat og integreret kontraventil incl. UPM3 pumpe.

Complete mixing kit with circulating pump, thermostatic valve with remote sensor, integrated non return valve.

Kompletter Mischer mit UPM3 Pumpe. Anschluß, selbstwirkendem Thermostat und integrierte Rückschlagventil.

ART. NO.	VVS	BOX	STATUS
7021SS		1	✓



7035TOP20

1" komplet fordelsystem rustfrit stål med topmeter incl. 20 mm fittings og slut prop.

Complete stainless steel manifold system with balancing top, in- and outlet, incl. brackets, fittings and end plug

Komplettes Verteilersystem mit Topmeter. Einschl. Wandhalterungen, Fittings und Endstopfen.

ART. NO.	DIMENSION	VVS	BOX	STATUS
7035TOP20-02	1" x 3/4"/2	04 6864 202	1	X
7035TOP20-03	1" x 3/4"/3	04 6864 203	1	X
7035TOP20-04	1" x 3/4"/4	04 6864 204	1	X
7035TOP20-05	1" x 3/4"/5	04 6864 205	1	X
7035TOP20-06	1" x 3/4"/6	04 6864 206	1	X
7035TOP20-07	1" x 3/4"/7	04 6864 207	1	X
7035TOP20-08	1" x 3/4"/8	04 6864 208	1	X
7035TOP20-09	1" x 3/4"/9	04 6864 209	1	X
7035TOP20-10	1" x 3/4"/10	04 6864 210	1	X
7035TOP20-11	1" x 3/4"/11	04 6864 211	1	X
7035TOP20-12	1" x 3/4"/12	04 6864 212	1	X

✓ in stock in Middelfart, X 2-4 weeks



MINISHUNT

MINISHUNT (SK20UPM-1) til én kredse. Incl. UPM2 15/20 pumpe og 20 mm PEX fittings. Max. 35 m².

MINISHUNT with one outlet. Incl. UPM2 15/20 pump and 20 mm PEX fittings. Max. 35m².

MINISHUNT mit eine Entleerung. Incl. UPM2 15/20 Pumpe und 20 mm PEX Fittings. Max. 35m².

ART. NO.		VVS	
761P-004	Fremløbsventil (anlæg), 1/2" Straight radiator valve, 1/2" Heizkörper- Durchgangsventil für Thermostat	40 3574 034	
073S	Pakdåse til fremløbsventil 761P Stuffing box for art. no. 761P Packdose für art. no. 761P	04 6899 010	
076	Indsats for fremløbsventil 761P 1/2" Headwork for 761P 1/2" Ventileinsatz für 761P 1/2"	40 3571 800	
650DIN-004	Returløbsventil (anlæg) Angle lockshield valve Heizkörper-Eck-Rücklaufverschraubung	40 3581 004	
761DPR-004	Returventil m/forindstilling (gulvarme) Straight radiator valve, with pre-setting device Heizkörper-Durchgangsventil mit Vorinstellung	40 3574 034	
107LKIT	Termostathoved for minishunt Thermostatic head for minikit Thermostatkorpf für Minishunt	40 3578 000	
076RAU	Ventil til termostat ventil 761DPR Valve for Straight radiator valve, 761DPR Ventile für Heizkörper-Durchgangsventil, 761DPR	40 3574 800	
GR-UPM-20	UPM2 15/20 pumpe til minishunt, 1 kredse UPM2 15/20 Pump for minishunt, 1 outlet UPM2 15/20 Pumpe für Minishunt, 1 Kreis		



7021 / 7025

Kompakt paralleleshunt med ligeløbende tilslutningssæt, selvvirkende termostat og integreret kontraventil mellem til- og afgang. Incl. UPM3 pumpe. Max. 250 m²
Complete mixing kit with circulating pump.

Kompletter Mischer mit UPM3 Pumpe.

ART. NO.		VVS	
073S	Pakdåse til fremløbsventil 761P Stuffing box for art. no. 761P Packdose für art. no. 761P	04 6899 010	
760ME-006	Fremløbsventil til paralleleshunt Thermostatic valve "only for shunt 7021", 3/4" angle valve Thermostatventil "nur für Mischer 7021", 3/4" Eckventil	40 3573 006	
751N-006	Ligeløbende returkobling. Forniklet. Nickel plated lockshield straight radiator valve Heizkörper-Rücklaufverschraubung	40 1834 006	
07021B	Bundestykke til paralleleshunt 7021 Bottom part for Mixing Kit 7021 Verschluss für Mischer 7021		
107LKIS	Termostathoved til paralleleshunt 7021 Thermostatic head for Mixing Kit 7021 Thermostatkopf für Mischer 7021	40 3578 002	
GR-UPM3	UPM3 pumpe 15/70 til paralleleshunt 7021 og 7025 UPM3 pump 15/70 for Mizing Kit 7021 and 7025 UPM Pumpe 15/70 für Mischer 7021 and 7025		

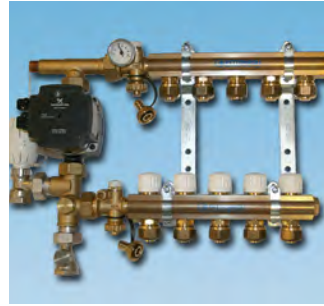

KVIKSHUNT

KVIKSHUNT: 2-12 kredse, UPM3 pumpe, 3/4" fordelerrør, 20 mm PEX fittings, u/forindstilling.

KVIKSHUNT: Complete underfl or heating system 2-12 outlets. UPM3 pump, 3/4" manifold, 20 mm PEX fittings, with ut pre-setting

KVIKSHUNT: Komplette Verteilersystem 2-12. UPM3 Pumpe, 3/4" Verteiler, 20 mm PEX Fittings, ohne Voreinstellung.

ART. NO.		VVS	
107CP-M28	Manuelt håndhjul til fordelerrør, retur Manual handwheel for manifold, return Handrad für Verteilerrohr Rücklauf	40 3589 107	
073S	Pakdåse til fremløbsventil 761P Stuffing box for art. no. 761P Packdose für art. no. 761P	04 6899 010	
073	Indsats for fordelerrør, retur Headwork for manifold, return Ventileinsatz für Verteilerrohr Rücklauf	04 6899 020	
T-60	Termometer 0-60°C Thermometer 0-60°C Thermometer 0-60°C		
GR-UPM3	Pumpe til KVIKSHUNT UPM3 15/50 (2-3 afg.) og 15/70, 4-12 afg. Pump for KVIKSHUNT UPM3 15/50 (2-3 outlets) and 15/70, 4-12 outlets Pumpe für KVIKSHUNT UPM3 15/50 (2-3 Kreise) und 15/70, 4-12 Kreise		
079	Ventilsæde til KVIKSHUNT Headwork til KVIKSHUNT Ventileinsatz für KVIKSHUNT		
073RP	Til forindstilling af gulvarmefordelerrør, retur Anvendes hvis én zone har to kredse som IKKE er lige lange Anvendes også til MINISHUNT solgt frem til 2016	04 6899 022	



7035

1" komplet fordelersystem incl. 10 mm fittings og 2 st . endestykker.

Complete manifold system, in- and outlet, incl. brackets, fittings and end pieces

Komplettes Verteilersystem. Einsch. Wandhalterungen, Fittings und Abschlußstücke.

ART. NO.		VVS	
0760P	Manuelt håndhjul, fordelerrør retur Manual handwheel, manifold return Handrad für Verteilerrohr Rücklauf	40 3589 060	
073S	Pakdåse til fremløbsventil 761P Stuffing box for art. no. 761P Packdose für art. no. 761P	04 6899 010	
073	Indsats for fordelerrør, retur Headwork for manifold, return Ventileinsatz für Verteilerrohr Rücklauf	04 6899 020	
074	Indsats (flowregulering) for fordelerrør, frem 7035DM, 1" Headwork for manifold 7035DM, 1" Ventileinsatz für 7035DM, 1"		
075	Ventilsæde til fremløb samt returløb, alm. fordelerrør, 1" Headwork for manifold, 7035DM and 7035TEM, 1" Ventileinsatz für 7035DM und 7035TEM, 1"		
078	Ventilsæde til topmeterfordelerrør, fremløb, 1" Headwork for manifold, 7035TO, 1" Ventileinsatz für 7035TO, 1"		
077	Topmeter til fordelerrør 7035TOP, 1" Balancing top meter for manifold 7035TOP, 1" Topmeter für verteilerrohre 7035TOP, 1"	04 6899 050	



3015

Komplet forskruningssæt lavet af messing, til PE og PEX rør. Rå messing.

Complete adapting set made of brass alloy for polyethylene pipes. Yellow.

Kompressionsfittings. Komplet aus Messing für PE und PEX Rohre. Gelb.

ART. NO.	3/4" gevind/18 mm konus	VVS	BOX	STATUS
3015-006-12/8	3/4" x 12/8	04 6845 111	10 / 200	✓
3015-006-12/10	3/4" x 12/10	04 6845 112	10 / 200	✓
3015-006-14/10	3/4" x 14/10	04 6845 114	10 / 200	X
3015-006-15/10	3/4" x 15/10	04 6845 115	10 / 200	✓
3015-006-16/11	3/4" x 16/11	04 6845 126	10 / 200	X
3015-006-16/116	3/4" x 16/11,6	04 6845 127	10 / 200	X
3015-006-16/12	3/4" x 16/12	04 6845 136	10 / 200	✓
3015-006-16/124	3/4" x 16/12,4	04 6845 137	10 / 200	X
3015-006-16/13	3/4" x 16/13	04 6845 616	10 / 200	X
3015-006-17/13	3/4" x 17/13	04 6845 117	10 / 200	✓
3015-006-18/13	3/4" x 18/13	04 6845 118	10 / 200	X

ART. NO.	DIMENSION	VVS	BOX	STATUS
3/4" gevind/18 mm konus				
3015-006-18/14	3/4" x 18/14	04 6845 128	5 / 100	X
3015-006-20/144	3/4" x 20/14,4	04 6845 120	5 / 100	X
3015-006-20/16	3/4" x 20/16	04 6845 620	5 / 100	✓
1" gevind/24,7mm konus				
3015-008-20/16	1" x 20/16	04 6845 150	5 / 100	X
3015-008-25/20	1" x 25/20	04 6845 155	5 / 100	X



3015SCR

Koblingssæt for ALUPEX- rør. Afzinkningsfri messing.

Complete adapting set made of brass for multilayer pipe. Non dezincifiable alloy. Yellow.

Korrosionsfeste Messinglegierung für ALU-PEX. Gelb

ART. NO.	DIMENSION	VVS	BOX	STATUS
3/4" gevind/18 mm konus				
3015SCR-006-16/116	3/4" x 16/11,6	04 6746 135	10 / 200	X
3015SCR-006-16/12	3/4" x 16/12	04 6746 136	10 / 200	✓
3015SCR-006-17/12	3/4" x 17/12	04 6746 137	10 / 200	X
3015SCR-006-20/155	3/4" x 20/15,5	04 6746 140	10 / 200	X
3015SCR-006-20/16	3/4" x 20/16	04 6746 141	10 / 200	✓
1" gevind - 24,7mm konus				
3015SCR-008-26/20	1" x 26/20	04 6746 156	10 / 200	X



3625

Komplet forskruningssæt af messing til kobber- og bløde stålør. Rå messing.

Complete adapting set made of brass for copper and soft steel pipes. Yellow.

Kompressionsfittings. Komplet aus Messing für Kupfer oder Weichstahlrohre. Gelb.

ART. NO.	DIMENSION	VVS	BOX	STATUS
3/4" gevind /8 mm konus				
3625-006-095	3/4" x 9,5	04 6842 109	10 / 200	X
3625-006-10	3/4" x 10	04 6842 110	10 / 200	X
3625-006-12	3/4" x 12	04 6842 112	10 / 200	✓
3625-006-127	3/4" x 12,7	04 6842 113	10 / 200	X
3625-006-14	3/4" x 14	04 6842 114	10 / 200	X
3625-006-15	3/4" x 15	04 6842 115	10 / 200	✓
3625-006-16	3/4" x 16	04 6842 116	10 / 200	X
3625-006-18	3/4" x 18	04 6842 118	10 / 200	X



035/1

Nippelkobling til kobber og polyethylen rør. Til manifold art. 7000PM.

Straight male coupling for copper and polyethylene pipes. For manifold 7000PM. Connection BS864.2 15mm copper.

Nippelkupplung für Kupfer und Polyethylenrohre. Für Fertigverteiler Typ 7000PM. Verschraubungen BS864.2 15mm Kupfer.

ART. NO.	DIMENSION	VVS	BOX	STATUS
035/1-064	1/2" x 3/4"	04 6885 644	20 / 400	✓



035/2

Lige koblingsnippel til kobber og polyethylen rør. Til art. 3015, 3525 og 3625.

Straight coupling for copper/polyethylene. For Art. 3015, 3525 and 3625. Yellow.

Kupplung für Kupfer/Polyethylen. Für Typen 3015, 3525 und 3625. Gelb.

ART. NO.	DIMENSION	VVS	BOX	STATUS
035/2-006	3/4" x 3/4"	04 6856 018	35 / 350	✓

✓ in stock in Middelfart, X 2-4 weeks



035M

Nippelkobling til manifold art. 7000 PM.
Straight male coupling for manifolds series 7000PM. Yellow.

Nippelkuppling für Fertigverteiler Typ 7000PM.

ART. NO.	DIMENSION	VVS	BOX	STATUS
035M-034	3/8" x 1/2"	04 6885 203	20 / 200	X
035M-044	1/2" x 1/2"	04 6885 204	20 / 200	✓



036/1

Lige koblingsmuffe til kobber og polyethylen rør. Til art. 3015, 3525 og 3625.

Straight female coupling for copper or polyethylene pipe. For Art. 3015, 3525 and 3625. Yellow.

Kupplungsmuffe für Kupfer oder Polyethylenrohre. Für Typen 3015, 3525 und 3625. Gelb.

ART. NO.	DIMENSION	VVS	BOX	STATUS
036/1-046	1/2" x 3/4"	04 6857 033	10 / 200	✓



035MP/1

Forskruningssæt nippel x ALUPEX. Rå messing.

Brass wall late straight male x multilayer pipe. Yellow.

Kompressionsfittings AG x ALU-PEX. Gelb.

ART. NO.	DIMENSION	VVS	BOX	STATUS
035MP/1-004-14/10	1/2" x 14/10	04 6838 614	12 / 120	X
035MP/1-004-17/12	1/2" x 17/12	04 6838 617	12 / 120	X
035MP/1-006-20/15,5	3/4" x 20/15,5	04 6838 720	12 / 120	X



036MP/1

Forskruningssæt muffe x ALUPEX. Rå messing.

Brass wall late straight female x multilayer pipe. Yellow.

Kompressionsfittings IG x ALU-PEX. Gelb.

ART. NO.	DIMENSION	VVS	BOX	STATUS
036MP/1-004-14/10	1/2" x 14/10	04 6838 014	12 / 120	X
035MP/1-004-17/12	1/2" x 17/12	04 6838 017	12 / 120	X
035MP/1-006-20/15,5	3/4" x 20/15,5	04 6838 120	12 / 120	X



035P/1

Forskruningssæt nippel x Ø25/20 polyethylen rør. Rå messing.

Brass wall late straight male x polyethylene pipe. Yellow.

Kompressionsfittings AG x Ø25/20 Polyethylenrohr. Gelb.

ART. NO.	DIMENSION	VVS	BOX	STATUS
035P/1-003-12/10	3/8" x 12/10	04 6848 003	12 / 120	X
035P/1-004-16/13	1/2" x 16/13	04 6848 004	12 / 120	X
035P/1-004-20/16	1/2" x 20/16	04 6848 014	12 / 120	✓
035P/1-006-20/16	3/4" x 20/16	04 6848 006	12 / 120	X
035P/1-006-25/20	3/4" x 25/20	04 6848 026	12 / 120	X
035P/1-008-25/20	1" x 25/20	04 6848 008	12 / 120	X



036P/1

Forskruningssæt 1" muffe x polyethylen rør. Rå messing.

Brass wall late straight female x polyethylene pipe. Yellow.

Kompressionsfittings 1" IG x Polyethylenrohr. Gelb.

ART. NO.	DIMENSION	VVS	BOX	STATUS
036P/1-003-12/10	3/8" x 12/10	04 6847 003	12 / 120	X
036P/1-004-16/13	1/2" x 16/13	04 6847 004	12 / 120	X
036P/1-004-20/16	1/2" x 20/16	04 6847 014	12 / 120	X
036P/1-006-20/16	3/4" x 20/16	04 6847 006	12 / 120	X

✓ in stock in Middelfart, X 2-4 weeks



3522M

Messingprop med pakning til liniære manifold serie 7000PM, 7025 og 7035.

Brass cap with washer for linear manifolds series 7000PM, 7025 and 7035.

Messingstopfen mit Dichtung für linienförmige Fertigverteiler Typ 7000PM, 7025 und 7035.

ART. NO.	DIMENSION	VVS	BOX	STATUS
3522M-003	3/8"	04 6889 703	50 / 500	X
3522M-004	1/2"	04 6889 704	50 / 500	✓
3522M-006	3/4"	04 6889 706	50 / 500	✓
3522M-008	1"	04 6889 708	25 / 250	✓
3522M-010	1.1/4"	04 6889 710	25 / 250	✓
3522M-011	1.1/2"	04 6889 711	5 / 50	X



3523

Messingprop med pakning. For afspærring af en gulvvarmekreds.

Brass cap with washer. For shutting of a circuit of the manifold.

Messingstopfen mit Dichtung. Für eine Fußbodenheizkreis zu Absperrren.

ART. NO.	DIMENSION	VVS	BOX	STATUS
3523-006	*3/4"	04 6889 820	10 / 200	✓
3523-008	1"	04 6889 808	10 / 200	✓

*7035TDM/MIDISHUNT/KVIKSHUNT



4523M

Udvendig x indvendig reduktionsadapter med pakning. Til manifold serie 7000PM, 7025 og 7035.

M x F brass reducing adapter with washer. For linear manifolds series 7000PM, 7025 and 7035. Yellow.

AG x IG Reduktionsadapter mit Dichtung. Für linienförmige Fertigverteiler Serie 7000PM, 7025 und 7035. Gelb.

ART. NO.	DIMENSION	VVS	BOX	STATUS
4523M-062	3/4" x 1/4"	04 6889 131	25 / 250	X
4523M-063	3/4" x 3/8"	04 6889 132	25 / 250	X
4523M-082	1" x 1/4"	04 6889 140	25 / 250	X
4523M-083	1" x 3/8"	04 6889 141	25 / 250	X
4523M-084	1" x 1/2"	04 6889 142	25 / 250	✓



4040

Udvendig x udvendig kobling til manifold serie 7000PM, 7025 og 7035.

M x M coupling for manifolds series 7000PM, 7025 and 7035. Yellow.

AG x AG Kupplung für Fertigverteiler Serie 7000PM, 7025 und 7035. Gelb.

ART. NO.	DIMENSION	VVS	BOX	STATUS
4040-006	3/4" x 3/4"	04 6885 106	25 / 250	✓
4040-008	*1" x 1"	04 6885 108	10 / 100	✓
4040-010	1.1/4" x 1.1/4"	04 6885 110	10 / 100	X
4040-011	1.1/2" x 1.1/2"	04 6885 311	5 / 50	X

*Til fordelerrør 7035TDM



070M

Endekobling udv. x indv. x indv. Til linære manifold serie 7000PM, 7025 og 7035.

Brass end coupling male x female x female. For linear manifolds series 7000PM, 7025, and 7035. Yellow.

Endkupplung AG x IG x IG. Für linienförmige Fertigverteiler Serie 7000PM, 7025 und 7035. Gelb.

ART. NO.	DIMENSION	VVS	BOX	STATUS
070M-643	3/4" x 1/2" x 3/8"	04 6890 235	10 / 200	X
070M-644	3/4" x 1/2" x 1/2"	04 6890 237	10 / 200	X
070M-843	1" x 1/2" x 3/8"	04 6890 256	10 / 200	✓
070M-844	1" x 1/2" x 1/2"	04 6890 257	10 / 200	✓
070M-A44	1.1/4" x 1/2" x 1/2"	04 6890 286	10 / 200	X



070TM

Termometerholder kobling til art. T40. Til lineære manifold serie 7000PM, 7025 og 7035.

Thermometer holder coupling for Art. T40. For linear manifolds series 7000PM, 7025 and 7035. Yellow.

Thermometerhalter Kupplung für Typ T40. Für linienförmige Fertigverteiler Typ 7000PM, 7025 und 7035. Gelb.

ART. NO.	DIMENSION	VVS	BOX	STATUS
070TM-883	1" x 1" x 3/8"	04 6891 269	10 / 100	X
070TM-AA3	1.1/4" x 1.1/4" x 3/8"	04 6891 299	10 / 100	X

✓ in stock in Middelfart, X 2-4 weeks



C80

Zinkmalet vægboks. Med justerbar ramme og 6 skruer til fastgørelse af monteringsholderne. Til manifold uden shunt og/eller KVIKSHUNT.

Zinc painted stove-enamelled wall box. With adjustable frame and 6 screws to fix the mounting brackets.

Verzinkter, einbrennlackierter Wandschrank. Mit justierbarem Rahmen und 6 Schrauben zur Befestigung der Montierhalterungen.

ART. NO.	DIMENSION (L x H x D)	VVS	BOX	STATUS
C80-2	/2 (600x700x120 - 170)	04 6887 206	1	X
C80-3	/3 (850 x 700 x 120 - 170)	04 6887 208	1	X
C80-4	/4 (1000x700x120-170)	04 6887 210	1	X
C80-5	/5 (1200x700x120-170)	04 6887 212	1	X



7080/1

Vægbeslag til manifold 7000, 7035, 7035TEM og 7035DM. Til installation i vægboks C70.

Steel zinc rag bolt for manifolds 7000PM, 7035M, 7035TEM and 7035DM. For installation in box C70 and C80.

Stahl Zink Halterung für Fertigverteiler 7000PM, 7035M, -TEM und -DM. Für Montage im Schrank C70 und C80.

ART. NO.	DIMENSION	VVS	BOX	STATUS
7080/1-006	3/4"	04 6898 106	10 / 40	✓
7080/1-008	1"	04 6898 108	10 / 40	✓
7080/1-010	1.1/4"	04 6898 110	10 / 40	✓



AC7014

Komplet afslutningsstykke til fordelersystem. Bestående af påfyldnings-/aftapshane og luftudlader.

Terminal set for manifold system incl. drain valve and manual air vent.

Komplettes Abschlußstück für Verteilersystem. Bestehend aus Endkupplung, und Entlüftungsventil.

ART. NO.	DIMENSION	VVS	BOX	STATUS
AC7014-008	1"	04 6893 008	2 / 20	✓
AC7014-010	1.1/4"	04 6893 010	2 / 20	✓
AC7014T-008*	1"	04 6893 108	2 / 20	✓
AC7014T-010*	1.1/4"	04 6893 110	2 / 20	✓

* med termometer / with thermometer / mit Thermometer



AC7035T

Komplet afslutningsstykke til fordelersystem. Bestående af påfyldnings-/aftapshane, luftudlader og termometer.

Terminal set for manifold system incl. drain valve, automatic air vent and thermometer.

Komplettes Abschlußstück für Verteilersystem. Bestehend aus Endkupplung, Entlüftungsventil und Thermometer.

ART. NO.	DIMENSION	VVS	BOX	STATUS
AC7035-008	1"	04 6894 008	2 / 20	✓
AC7035-010	1.1/4"	04 6894 010	2 / 20	✓
AC7035T-008*	1"	04 6894 108	2 / 20	✓
AC7035T-010*	1.1/4"	04 6894 110	2 / 20	✓

* med termometer / with thermometer / mit Thermometer



AC7014L/LT

Komplet tilslutningsstykke til 3/4" fordelersystem. Med påfyldnings-/aftapshane og luftskruer. Med/uden termometer.

Terminal set for 3/4" manifold system incl. drain valve and manual air vent. With/without Thermometer.

Komplettes Abschlußstück für 3/4" Verteilersystem. Met Endkupplung und Entlüftungsventil. Mit/ohne Thermometer

ART. NO.	DIMENSION	VVS	BOX	STATUS
AC7014L	3/4"	04 6893 222	1	✓
AC7014LT*	3/4"	04 6893 322	1	✓

* med termometer / with thermometer / mit Thermometer



ACC7021

Komplet vinkelstykke til parallelshunt art. no. 7021 (1" fordeler).

Angle set for mixing kit art.no. 7021 (1" manifold).

Winkelsatz für Mischer 7021 (1" Verteilersystem).

ART. NO.	VVS	BOX	STATUS
ACC7021	46 6209 106	10 / 100	✓

✓ in stock in Middelfart, X 2-4 weeks



696/97

Automatisk udluftningsventil med kontra-ventil.

Automatic air vent with non-return stop valve.

Automatischer Entlüftungsventil mit Absperventil.

ART. NO.	DIMENSION	VVS	BOX	STATUS
696/97-003	3/8"	44 7082 003	1 / 50	✓
696/97-004	1/2"	44 7082 004	1 / 50	✓



52CE/3

Kuglehane "New Compact" med fuldt gennemløb. Muffe/forskrugging. Rødt T-greb.

"New Compact" fullway female ball valve with tail. Red butterfly handle

Kugelhahn "New Compact" mit vollem Durchgang I x A mit Verschraubung und rotem Flügelgriff.

ART. NO.	DIMENSION	VVS	BOX	STATUS
52CE/3-004	1/2" x 1/2"	42 7872 704	16 / 96	✓
52CE/3-006	3/4" x 3/4"	42 7872 706	8 / 48	✓
52CE/3-008	1" x 1"	42 7872 708	5 / 30	✓
52CE/3-010	1.1/4" x 1.1/4"	42 7872 710	4 / 24	✓



35T

Termometerholder kobling til manifold serie 7035TDM med tilslutning 18 (G3/4").

Thermometer holder coupling for manifold outlets series 7035TDM, with Euroconus connection G3/4".

Thermometerhalter Kupplung für Fertigverteiler Abgänge 7035TDM mit Anschluß 18(G3/4").

ART. NO.	DIMENSION	VVS	BOX	STATUS
35T x 18 x 18 x 003	18 x 18 (G3/4") x 3/8"	04 6891 218	15 / 150	X



T40

Termometer 0-60 °C eller 0-80 °C skala med gevindtilslutning Ø3/8" udv.

Thermometer 0-60 °C or 0-80 °C scale with threaded connection Ø3/8".

Thermometer 0-60 °C oder 0-80 °C Skala mit Gewindeanschluß Ø3/8".

ART. NO.	DIMENSION	VVS	BOX	STATUS
T40-60	/60 - 3/8" (0 - 60 °C)	48 0627 063	10 / 100	✓
T40-80	/80 - 3/8" (0 - 80 °C)	48 0627 083	10 / 100	✓



0991B

Unbrakonøgle for indregulering af manifold 7035DM og 7035TDM.

Hexagonal key 6 mm for lockshield valves series 991 and manifold series 7035D.

Sechskantschlüssel 6 mm für Rücklaufverschraubungen Serie 991 und Verteiler serie 7035D.

MM	VVS	BOX	STATUS
6 (0991B)	04 6889 916	100	✓



0760P

Håndhjul til radiatorventiler og manifold 7035TDM og 7035TEM.

Handwheel for radiator valves and manifold 7035TDM and 7035TEM.

Handrad für 7035TDM und 7035TEM.

ART. NO.	VVS	BOX	STATUS
0760P	40 3589 060	20 / 200	✓



919

Åben ringnøgle til brugsvands- og gulvvarmefordeler. Til spænding af omløber Art. 3015, 3625, BI-219 og BI-220.

Key for nuts tightening. For Art. 3015, 3625, BI-219 and BI-220.

Schlüssel zur Befestigung der Überwurfmutter Typ 3015, 3625, BI-219 und BI-220.

ART. NO.	VVS	BOX	STATUS
919-24/30	04 6849 935	10	✓



APR40405

Termoelektrisk telestat uden adapter. 0-10V - 24V - 1W.

Thermo-electric actuator without adapter. 0-10V - 24V - 1W.

Thermoelektrischer Stellantrieb ohne Adapter. 0-10V - 24V - 1W

ART. NO.	DIMENSION	VVS	BOX	STATUS
APR40405-00-1N	1-10W	40 3596 724	1	✓



BI-50X

Brugsvandsfordelerrør CC50, 2, 3 og 4 afgange. Messing med TEA-overflade. Med fittings til PEX eller A U-PEX.

Manifold CC50, 2, 3 or 4 outlets. Brass with TEA-surface. With fittings for PEX or ALU-PEX pipes.

Verteiler CC50, 2, 3 und 4 Abgänge. Messing mit TEA Oberfläche. Mit Fittings für PEX oder ALU-PEX.

CC50

VARENDR.	DIMENSION	WVS	BOX	STATUS
Incl. Fittings 15/10 mm (PEX)				
BI-502XT (15/10)	3/4" x 1/2" x 2	04 6895 502	1 / 15	✓
BI-503XT (15/10)	3/4" x 1/2" x 3	04 6895 503	1 / 10	✓
BI-504XT (15/10)	3/4" x 1/2" x 4	04 6895 504	1 / 8	✓
Incl. Fittings 16/12 mm (ALU-PEX)				
BI-502AT (16/12)	3/4" x 1/2" x 2	04 6896 502	1 / 15	✓
BI-503AT (16/12)	3/4" x 1/2" x 3	04 6896 503	1 / 10	✓
BI-504AT (16/12)	3/4" x 1/2" x 4	04 6896 504	1 / 8	✓



BI-20XPT

Brugsvandsfordelerrør CC35, 2, 3 eller 4 afgange. Messing med TEA-overflade. Med/uden 15 mm fittings til PEX

Manifold CC35 2, 3 or 4 outlets. Brass with TEA-surface. With / without 15 mm fitting or polyethylene pipe.

Verteiler CC 35 2, 3 oder 4 Abgänge. Messing mit TEA Oberfläche. Mit/ohne 15 mm Fittings (PEX)

CC35

ART. NO.	DIMENSION	WVS	BOX	STATUS
BI-202PT	3/4" x 1/2" x 2	04 6882 402	8 / 96	✓
BI-203PT	3/4" x 1/2" x 3	04 6882 403	8 / 96	✓
BI-204PT	3/4" x 1/2" x 4	04 6882 404	8 / 96	✓



BI-20XPT

Brugsvandsfordelerrør CC35, 2, 3 eller 4 afgange. Messing med TEA-overflade. Med/uden 15 mm fittings til PEX

Manifold CC35 2, 3 or 4 outlets. Brass with TEA-surface. With / without 15 mm fitting or polyethylene pipe.

Verteiler CC 35 2, 3 oder 4 Abgänge. Messing mit TEA Oberfläche. Mit/ohne 15 mm Fittings (PEX)

CC35

ART. NO.	DIMENSION	WVS	BOX	STATUS
Incl. Fittings 15mm				
BI-202PT-15/10	3/4" x 1/2" x 2	04 6895 402	1 / 15	✓
BI-203PT-15/10	3/4" x 1/2" x 3	04 6895 403	1 / 10	✓
BI-204PT-15/10	3/4" x 1/2" x 4	04 6895 404	1 / 10	✓
Incl. Fittings 16mm				
BI-202PT-16/12	3/4" x 1/2" x 2	04 6896 402	1 / 15	✓
BI-203PT-16/12	3/4" x 1/2" x 3	04 6896 403	1 / 10	✓
BI-204PT-16/12	3/4" x 1/2" x 4	04 6896 404	1 / 10	✓



FITTINGS TEA

Forskrumningssæt til PEX og ALUPEX-rør. Messing med TEA-overflade

Complete adapting set for polyethylene and multilayer pipe. Brass with TEA-surface.

Kompressionsfittings aus Messing für PEX und ALU-PEX Rohre. Mit TEA Oberfläche.

VARENDR.	DIMENSION	WVS	BOX	STATUS
3015TEA-006-15/10	3/4" x 15/10 (PE / ALU-PEX)	04 6895 615	10 / 200	✓
3015TEA-006-18/13	3/4" x 18/13 (PE / ALU-PEX)	04 6895 618	10 / 200	✓
3015TEA-006-20/16	3/4" x 20/16 (PE / ALU-PEX)	04 6895 620	10 / 200	✓
BI-219PT	1/2"x16/12 (ALU-PEX)	04 6896 026	50 / 500	✓
BI-220PT	1/2"x15/10 (PEX)	04 6895 125	50 / 500	✓



BI-7081

Vægbeslag til 3/4" fordelerrør sæt af 2 stk.

Wall bracket for 3/4" manifold, set of 2 pcs.

Halterung für 3/4" Fertigverteiler, 2 Stück.

ART. NO.	DIM.	WVS	BOX	STATUS
BI-7081	3/4"	04 6882 916	1 / 25	✓



IS500

Isolering til brugsvandsfordelerrør 4 afgreninger.

Insulation for manifold, 4 outlets

Isolierung für Brauchwasserverteilerrohr 4 Abzweige..

ART. NO.	DIM.	WVS	BOX	STATUS
IS500	3/4"	04 6868 930	1 / 50	✓



BI-231PT

Endeprop til 3/4" fordelerrør. Messing med TEA-overflade

Cap for 3/4" manifolds. Brass with TEA-surface.

Endstopfen für 3/4" Verteiler. Messing mit TEA Oberfläche.

VARENR.	DIMENSION	VVS	BOX	STATUS
BI-231PT	3/4"	04 6882 926	1/10	✓

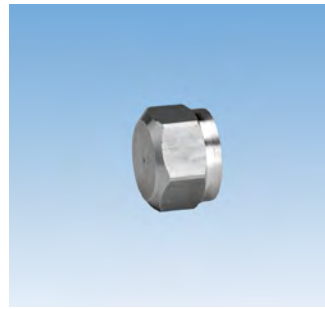

BI-227PT

Slutmuffe til 3/4" fordelerrør. Messing med TEA-overflade

Cap for 3/4" manifolds. Brass with TEA-surface.

Messingstopfen für 3/4" Verteiler. Messing mit TEA Oberfläche.

VARENR.	DIMENSION	VVS	BOX	STATUS
BI-227PT	3/4"	04 6882 946	1/30	✓



035/2TEA-006

Nippelstykke til 3/4" fordelerrør. Messing med TEA-overflade

Male coupling for 3/4" manifolds. Brass with TEA-surface.

Nippelkupplung für 3/4" Verteiler. Messing mit TEA Oberfläche.

VARENR.	DIMENSION	VVS	BOX	STATUS
035/2TEA-006	3/4"x3/4"	04 6856 118	10/200	✓

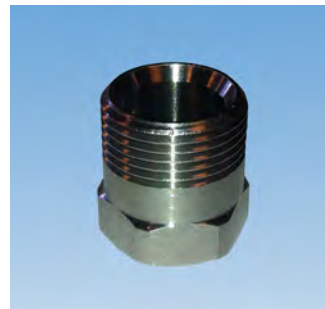

036/1TEA-064

Koblingsmuffe til 3/4" fordelerrør. Messing med TEA-overflade

Female coupling for 3/4" manifolds. Brass with TEA-surface.

Kupplungsmuffe für 3/4" Verteiler. Messing mit TEA Oberfläche.

VARENR.	DIMENSION	VVS	BOX	STATUS
036/1TEA-064	3/4" x 1/2" (N x M)	04 6882 954	10/200	✓



BI-20X

Brugsvandsfordelerrør CC35, med 2, 3 og 4 afgange. Rå messing. Med/uden 15 mm fittings til PEX

Brass manifold CC35 with 2, 3 and 4 outlets for water- and heating systems. With/without 15 mm fittings (PEX)

Messing Verteilerrohr CC35 mit 2, 3 und 4 Abgängen für Wasser und Wärmesystemen. Mit/ohne 15 mm Fittings (PEX).

CC35

ART. NO.	DIMENSION	VVS	BOX	STATUS
BI-202	3/4" x 1/2" x 2	04 6882 202	8 / 96	✓
BI-203	3/4" x 1/2" x 3	04 6882 203	8 / 96	✓
BI-204	3/4" x 1/2" x 4	04 6882 204	8 / 96	✓
Incl. Fittings 15mm				
BI-202-15/10	3/4" x 1/2" x 2	04 6895 202	1 / 15	✓
BI-203-15/10	3/4" x 1/2" x 3	04 6895 203	1 / 10	✓
BI-204-15/10	3/4" x 1/2" x 4	04 6895 204	1 / 10	✓



BI-2XX

Fittings til brugsvandsfordelerrør. Rå messing. Til PEX og ALU-PEX rør.

Fittings for brass manifold. For PEX and ALU-PEX.

Kompressionsfittings aus Messing für PEX und ALU-PEX Rohre.

ART. NO.	DIMENSION	VVS	BOX	STATUS
FITTINGS - rå messing / brass / Messing				
BI-219	1/2"x16/12 (ALU-PEX)	04 6896 016	50 / 500	✓
BI-220	1/2"x15/10 (PEX)	04 6895 015	50 / 500	✓
BI-231	3/4"	04 6882 906	50 / 500	✓



Hvor mange kredse skal du bruge?

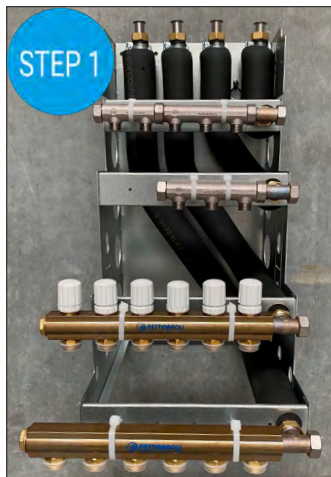
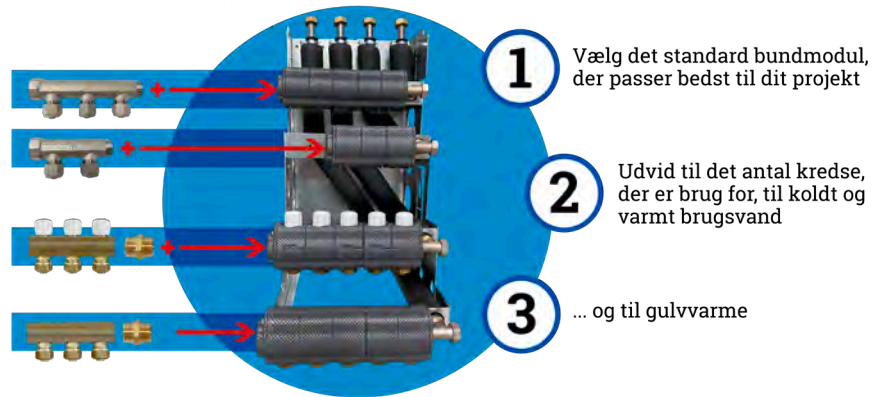

Standard BUNDMODUL:
BE-BASICPTM-653

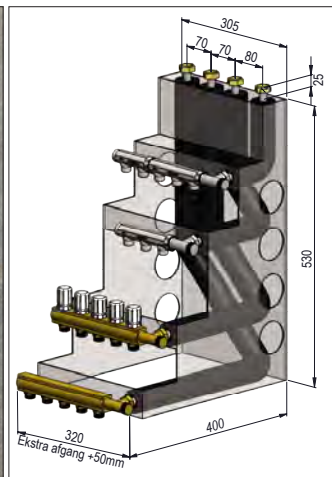

BE-BASICPTM: passer til Termix og Metrotherm fjernvarmeunits

- hjælper med at holde styr på rørene!

Pettinarolis BUNDMODUL sikrer en hurtig og nem installation af såvel gulv-varme og brugsvand i alle tænkelige projekter.

Selve BUNDMODULET har en funktionel, robust og stabil opsætning. Det består af et solidt kabinet med beslag for brugsvand, gulvvarme samt diverse tilbehør.

BUNDMODULET er incl. føderør for manifold, som er fuldt isoleret iht. DS452, der sikrer et minimalt varmetab fra installationen.

Med denne løsning opnås et ensartet udseende på varme- og brugsvandsinstallationer. Samtidig spares der tid ved montering, samt risikoen for fejlmontering minimeres i alle former for boligbyggeri.

BUNDMODULER til fjernvarmeunits

Pettinaroli tilbyder et standard BUNDMODUL, som passer til Termix og Metrotherm (model TM) fjernvarmeunits.

BUNDMODULET er opbygget over et robust kabinet og kan placeres i et almindeligt 60 cm køkkenskab.

Standardbundmodulerne er konfigureret med:

- 5 eller 6 gulvvarmekredse
- 5 koldtvandskredse
- 3 varmtvandskredse
- incl. isolering

Læs mere om bundmoduler og skaktløsninger:



STANDARDLØSNINGER (STEP 1):

Centerafstand: cc70/80 ved forsyningsrørene

Passer til: Termix og Metrotherm
BE-BASICPTM-553 (5GV, 5KV, 3VV)
BE-BASICPTM-653 (6GV, 5KV, 3VV)

VVS-nr. 40 2022 155
VVS-nr. 40 2022 165



BI-50X/IS500

Udvidelsessæt til standardløsninger af bundmoduler og skaktløsninger.

Brugsvandsfordelerrør med TEA overflade til varmt og koldt vand. Centerafstand: 50 mm med 2, 3 eller 4 afgange, incl. 3/4" - 15/10 fittings

Isolering med 4 afgange, som passer til brugsvandsfordelerrøret

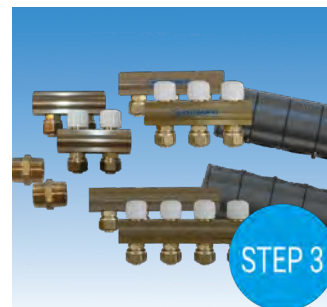

MGUV-0X

Udvidelsessæt til standardløsninger af bundmoduler og skaktløsninger.

3/4" gulvvarmefordelerrør - frem og retur - 2, 3 og 4 afgange.

Incl. samlestykke nippel/nippel, incl. 3/4" - 20/16 fittings samt isolering

ART. NO.	BESKRIVELSE	VVS	BOX	STATUS
BI-502XT (15/10)	3/4" x 1/2" x 2	04 6895 502	1	✓
BI-503XT (15/10)	3/4" x 1/2" x 3	04 6895 503	1	✓
BI-504XT (15/10)	3/4" x 1/2" x 4	04 6895 504	1	✓
IS500	4 afg.	04 6868 930	1	✓

*Standardløsninger med dag til dag levering.

ART. NO.	BESKRIVELSE	VVS	BOX	STATUS
MGUV-02	2 afg.	04 6879 926	1	✓
MGUV-03	3 afg.	04 6879 936	1	✓
MGUV-04	4 afg.	04 6879 946	1	✓

*Standardløsninger med dag til dag levering.



Hvor mange kredse skal du bruge?

Vælg den standard skaktløsning, der passer bedst til dit projekt

Udvid til det antal kredse, der er brug for, til koldt og varmt brugsvand

... og til gulvvarme

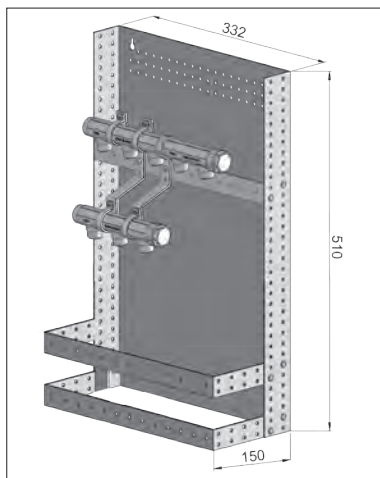
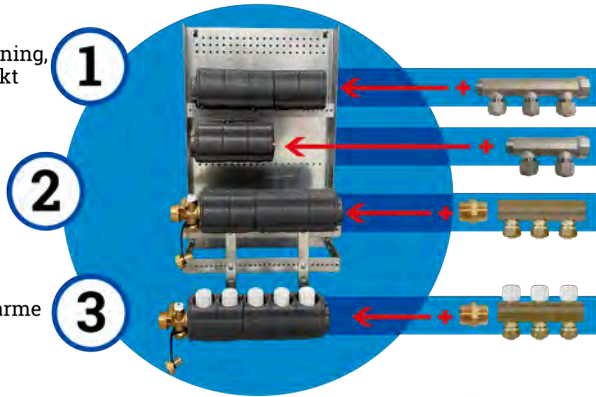

Skaktløsning med mål uden gulvvarme og brugsvand.



Skaktløsning med ekstra tilbehør: gul varmestyring og telestater.



* Skaktløsning med 5 eller 6 gulvvarme-, 5 koldtvals- og 3 varmtvandskredse.

Pettinarolis skaktløsning sikrer på samme måde som BUNDMODULET, en hurtig og nem installation af såvel gulvvarme, vand til radiatorer og brugsvand i alle tænkelige projekter og boligbyggerier.

Skaktløsningen er lidt mere enkel i opbygningen, men har også en funktionel og stabil opsætning. Den består af en bagplade, beslag for brugsvand, radiatorer og gulvvarme.

Det er en meget fleksibel løsning på trængte steder og bl.a. optimal ved renovering og nybyg af etageejendomme.

Der opnås på samme vis, som med BUNDMODULET, en ensartet kvalitet og udseende på varme- og brugsvandsinstallationer.

Der kan hurtigt spares meget tid ved montering, samtidig med at risikoen for fejlmontering minimeres.

STANDARDLØSNINGER*:

BE-BASIC-053	Skaktløsning, KUN brugsvand 5KV og 3VV	VVS-nr. 40 2022 805
BE-BASIC-553	*Skaktløsning, 5GV, 5KV og 3VV	VVS-nr. 40 2022 855
BE-BASIC-653	*Skaktløsning, 6GV, 5KV og 3VV	VVS-nr. 40 2022 865

Læs mere om bundmoduler og skaktløsninger.



BI-50X/IS500

Udvidelsessæt til standardløsninger af bundmoduler og skaktløsninger.

Brugsvandsfordelerrør med TEA overflade til varmt og koldt vand. Centerafstand: 50 mm med 2, 3 eller 4 afgange, incl. 3/4" - 15/10 fittings

Isolering med 4 afgange, som passer til brugsvandsfordelerrøret

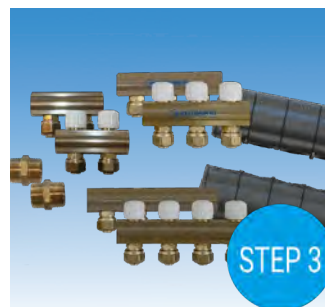

MGUVU-0X

Udvidelsessæt til standardløsninger af bundmoduler og skaktløsninger.

3/4" gulvvarmefordelerrør - frem og retur - 2, 3 og 4 afgange.

Incl. samlestykke nippel/nippel, incl. 3/4" - 20/16 fittings samt isolering

ART. NO.	BESKRIVELSE	VVS	BOX	STATUS
BI-502XT (15/10)	3/4" x 1/2" x 2	04 6895 502	1	✓
BI-503XT (15/10)	3/4" x 1/2" x 3	04 6895 503	1	✓
BI-504XT (15/10)	3/4" x 1/2" x 4	04 6895 504	1	✓
IS500	4 afg.	04 6868 930	1	✓

*Standardløsninger med dag til dag levering.

ART. NO.	BESKRIVELSE	VVS	BOX	STATUS
MGVU-02	2 afg.	04 6879 926	1	✓
MGVU-03	3 afg.	04 6879 936	1	✓
MGVU-04	4 afg.	04 6879 946	1	✓

*Standardløsninger med dag til dag levering.



107LKIT

Termostathoved til MINISHUNT.
Thermostatic head for MINISHUNT.
Thermostatkopf für MINISHUNT.

TIL MINISHUNT

ART. NO.	DIMENSION	WVS	BOX	STATUS
107LKIT	M28 x 1,5	40 3578 000	1	✓



107LKIS

Termostathoved til KVIKSHUNT og parallelshunt 7021/7K025.
Thermostatic head for KVIKSHUNT and Mixing Kit 7021/K7025.
Thermostatkopf für KVIKSHUNT und Mischer 7021/K7025.

TIL KVIKSHUNT

ART. NO.	DIMENSION	WVS	BOX	STATUS
107LKIS	M28 x 1,5	40 3578 002	1	✓



107LKIH

Termostathoved med anlægsføler, temperaturskala **40° - 65°C**.
Thermostatic head, temperatur range, 40° - 65°C.
Thermostatkopf für, Temperature 40° - 65°C.

TIL KVIKSHUNT

ART. NO.	DIMENSION	WVS	BOX	STATUS
107LKIH	40° - 65°C	40 3578 630	1	✓



109L

"DOMIGNON" termostathoved højglanspoleret med indbygget væskefyldt føler. Temperaturlås og tyverisikret anordning.
"DOMIGNON" thermostatic head with liquid sensor incorporated with temperature locking device and anti-theft device.
"DOMIGNON" Thermostatkopf, mit eingebautem Flüssigkeitsfühler, Temperatursperre und Diebstahl-sicherung.

ART. NO.	DIMENSION	WVS	BOX	STATUS
109L*	28 x 1,5	40 3578 640	1	✓
109LCRO**	28 x 1,5	40 3578 635	1	✓

* Hvid, white, Weiss ** Krom, Chromium, Krom



107LHN

Termostathoved med indbygget væskefyldt føler og temperaturlåsering. Til Heimeier tilslutning eller lign. (M30X1,5).
Thermostatic head with liquid sensor incorporated with temperature locking device. For Heimeier connection or similar.
Thermostatkopf mit eingebautem Flüssigkeitsfühler und Temperatursperre. Für Heimeier Anschluß oder ähnliches.

ART. NO.	DIMENSION	WVS	BOX	STATUS
107LHN	M30 x 1,5	40 3578 620	1	✓



107L

"OVAL" termostathoved med indbygget væskefyldt føler. Til ventiler serie 760P og 800P.
"OVAL" thermostatic head with liquid sensor incorporated with temperature locking device. For all thermostatic valves.
"OVAL" Thermostatkopf mit eingebautem Flüssigkeitsfühler. Für Ventilserien 760P und 800P.

ART. NO.	DIMENSION	WVS	BOX	STATUS
107L	M28 x 1,5	40 3578 600	1	✓



106CN

Termostathoved med indbygget voksføler, med temperaturlåsering. Til ventiler serie 760P og 800P.
Thermostatic head with wax sensor incorporated with temperature locking device. For all thermostatic valves.
Thermostatkopf mit eingebautem Feststofffühler und Temperatursperre. Für Ventilserien 760P og 800P

ART. NO.	DIMENSION	WVS	BOX	STATUS
106CN	M28 x 1,5	40 3578 300	1	✓



10 bar - 110°C non shock

760P/760DPR

Vinkelløbende radiatorventil til termostat eller aktuator. Indvendigt gevind. Forniklet. (760DPR - med forindstilling).

Angle radiator valve, with thermostatic option or thermo-electric control. Female thread. Nickel plated. (760DPR with pre-setting device).

Heizkörper-Eckventil für Thermostat oder elektrischer Stellantrieb. IG. Vernickelt. (760DPR mit Voreinstellung).

ART. NO.	DIMENSION	VVS	BOX	STATUS
760P-003	3/8"	40 3571 003	10 / 100	✓
760P-004	1/2"	40 3571 004	10 / 100	✓
760P-006	3/4"	40 3571 006	5 / 50	✓
760DPR-003	3/8"	40 3575 033	10 / 100	X
760DPR-004	1/2"	40 3575 034	10 / 100	X



10 bar - 110°C non shock

761P/761DPR

Ligeløbende radiatorventil til termostat eller aktuator. Indvendigt gevind. Forniklet. (761DPR - med forindstilling).

Straight radiator valve, with thermostatic option or thermo-electric control. Female thread. Nickel plated. (761DPR with pre-setting device).

Heizkörper-Durchgangsventil für Thermostat oder elektrischer Stellantrieb. IG. Vernickelt. (761DPR mit Voreinstellung).

ART. NO.	DIMENSION	VVS	BOX	STATUS
761P-003	3/8"	40 3570 003	10 / 100	✓
761P-004	1/2"	40 3570 004	10 / 100	✓
761P-006	3/4"	40 3570 006	5 / 50	✓
761DPR-003	3/8"	40 3574 033	10 / 100	X
761DPR-004	1/2"	40 3574 034	10 / 100	✓



10 bar - 110°C non shock

763H

Ligeløbende radiatorventil med høj Kv værdi til termostat eller aktuator. Indvendigt gevind. Forniklet.

Straight micrometric high fl w radiator valve, with thermostatic option or thermo-electric control. Female thread. Nickel plated.

Heizkörper-Durchgangsventil mit hohe Kv Werte für Thermostat oder elektrischer Stellantrieb. IG. Vernickelt.

ART. NO.	DIMENSION	VVS	BOX	STATUS
763H-006	3/4"	40 3620 006	5 / 50	✓



10 bar - 110°C non shock

800P/800PPR

Omvendt vinkelløbende radiatorventil til termostat eller aktuator. Indvendigt gevind. Forniklet.

Inverse angle radiator valve with thermostatic option or thermo-electric control. Female thread. Nickel plated.

Heizkörper-Axialventil für Thermostat oder elektrischer Stellantrieb. Innengewinde. Vernickelt.

ART. NO.	DIMENSION	VVS	BOX	STATUS
800P-004	1/2"	40 3569 004	10 / 100	X

Med forindstilling/with presetting device/mit Voreinstellung				
800PPR-004	1/2"	40 3569 034	10 / 100	X



10 bar - 110°C non shock

750N

Vinkelløbende returkobling. Forniklet.

Nickel plated lockshield angle radiator valve.

Heizkörper-Rücklaufverschraubung. Eckform. Vernickelt.

ART. NO.	DIMENSION	VVS	BOX	STATUS
750N-006	3/4"	40 1835 006	5 / 50	✓



10 bar - 110°C non shock

751N

Ligeløbende returkobling. Forniklet.

Nickel plated lockshield straight radiator valve.

Heizkörper-Rücklaufverschraubung. Durchgangsform. Vernickelt.

ART. NO.	DIMENSION	VVS	BOX	STATUS
751N-006	3/4"	40 1834 006	5 / 100	✓



10 bar - 110°C non shock

750R

Vinkelløbende regulerbar returkobling med O-ring. Indvendigt gevind. Forniklet.

Angle micrometric radiator lockshield valve with O-ring. Female thread. Nickel plated.

Heizkörper-Eck-Rücklaufverschraubung mit O-ring. Voreinstell- und absperrbar. Innengewinde. Vernickelt.

ART. NO.	DIMENSION	VVS	BOX	STATUS
750R-003	3/8"	40 1833 003	10 / 100	✓
750R-004	1/2"	40 1833 004	10 / 100	✓



10 bar - 110°C non shock

751R

Ligeløbende regulerbar returkobling med O-ring. Indvendigt gevind. Forniklet.

Straight micrometric radiator lockshield valve with O-ring. Female thread. Nickel plated.

Heizkörper-Durchgangs-Rücklaufverschraubung mit O-ring. Voreinstell- und absperrbar. Innengewinde. Vernickelt.

ART. NO.	DIMENSION	VVS	BOX	STATUS
751R-003	3/8"	40 1832 003	10 / 100	✓
751R-004	1/2"	40 1832 004	10 / 100	✓

✓ in stock in Middelfart, X 2-4 weeks



927

Drejelig H-ventil for enkelte og dobbelte rørsystemer. Termostatventil, aftap og by-pass. Forniklet.

Turnable H-valve for single-double pipe systems. Thermostatic valve, drainable and by-pass feature. Nickel plated.

Drehbares H-ventil für Ein- oder Zweistranganlagen. Thermostatventile, Entleerungsventil und By-pass. Vernickelt.

ART. NO.	DIMENSION	WVS	BOX	STATUS
927-006	3/4" x 18	04 4407 106	1 / 25	X
927-064	3/4" x 1/2"	04 4407 133	1 / 25	X

10 bar - 110°C non shock



K927

Drejbar H-ventil for enkelt og dobbelt rørsystem. Komplet med termostatventil, aftap, bypass og beskyttelseskappe.

Complete kit with 50 mm centre inlets and Euroconus (G3/4" x 18 mm) connections. the kit includes: thermostatic head (N28 x 1,5) Art.. 927 and Art. 0927.

H-Ventil für Ein- und Zweistrangsysteme. Komplett mit Thermostatventil, Entleerung, Bypass sowie Schutzkappe.

ART. NO.	DIMENSION	WVS	BOX	STATUS
K927C*	M28 x 1,5	40 4409 106	1 / 5	✓
K927**	M28 x 1,5	40 4409 126	1 / 5	✓
K927ZC*	M30 x 1,5	40 4409 230	1 / 5	X
K927Z**	M30 x 1,5	40 4409 330	1 / 5	✓

*Krom, Chromium, Krom **Hvid, white, Weiss

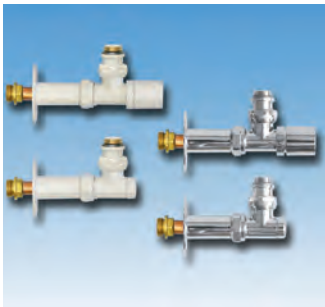

KK850

Design ventsæt i krom eller hvid. 1/2" vinkelløbende.

Design valve set in chrome or white. 1/2" angle valve.

Designventilsatz in Chrom oder Weiß. 1/2" Eckform.

ART. NO.	DIMENSION	WVS	BOX	STATUS
KK850*	1/2"	40 3585 104	1	✓
KK850B**	1/2"	40 3585 124	1	✓

*Krom, Chromium, Krom **Hvid, white, Weiss



3625D

Fitting til kobber / stålrør. For design ventsæt art.nr. KK850. Krom eller hvid.

Fitting for copper / steel pipes. For design valve set art.no. KK850. Chrome or white.

Montage für Kupfer / Stahlrohre. Für Designventilsatz Art.Nr. KK850, Chrom oder Weiß.

ART. NO.	DIMENSION	WVS	BOX	STATUS
3625D-006-15	3/4" x 15 mm	04 6859 015	1	✓
3625DB-006-15	3/4" x 15 mm	04 6859 315	1	✓

3625DB



107CP

Håndhjul til fordelerrør (fremløb) og serie 760P, 800P og 927.

Handwheel for manifold and radiator valve series 760P, 800P (M28 x 1,5) and valve 927 (M300 x 1,5).

Weißes Handrad für Verteilerrohr, Heizkörperventile Serie 760, 800P (M28 x 1,5) und Ventil Typ 927 (M300 x 1,5).

ART. NO.	WVS	BOX	STATUS
M28x1,5	40 3589 107	30	✓
M30x1,5	40 3589 127	30	X



701CG

Vandmålerforskruningssæt med kontrol-
lerbar kontraventil. CW724R 0,1% bly. 1 stk.
m/kontraventil og 1 stk. u/kontraventil.

Water meter set with controlla-
ble non-return valve. CW724R 0.1% lead. 1 pc
with non-return valve and 1 pc without check valve.

Wasserzähler-Einschraubset mit steuerba-
rem Rückschlagventil. CW724R 0,1 % Blei.

Med Kontraventil
With non-return valve
Mit Rückschlagventil

ART. NO.	DIMENSION	VVS	BOX	STATUS
701CG-004	1/2" x 3/4"	484911004	50	✓
701CG-006	3/4" x 1"	484911006	25	✓

DIM: (nippel x omløber / Tail x nut / A x I)



701CKN

Varmemålerforskruning med omløber
og grafitbelagt fib pakning. Rå messing.

Heat meter connection union. With
graphite coated fibre packing.ellow.

Wärmezählerverschraubung mit graphit-
beschichteter Fibernichtung. Gelb.

ART. NO.	DIMENSION	VVS	BOX	STATUS
701CKN-004	1/2" x 3/4" (set of 2)	48 4971 004	50	✓
701CKN-006	3/4" x 1" (set of 2)	48 4971 006	30	X
701CKN-008	1" x 1.1/4"	48 4971 008	30	✓
701CKN-010	1.1/4" x 1.1/2"	48 4971 010	50	X
701CKN-011	1.1/2" x 2"	48 4971 011	40	✓

DIM: (nippel x omløber / Tail x nut / A x I)



701C

Vandmålerforskruning med omløber
(CA701C) og NBR pakning (GU701). Rå
messing.

Complete brass water meter connection
union. With NBR rubber washer (GU701).
Yellow.

Wasserzählerverschraubung mit NBR
Dichtung (GU701). Gelb.

ART. NO.	DIMENSION	VVS	BOX	STATUS
701C-004	1/2" x 3/4"	48 4900 004	15 / 150	✓
701C-006	3/4" x 1"	48 4900 006	10 / 100	✓
701C-008	1" x 1.1/4"	48 4900 008	10 / 100	✓

DIM: (nippel x omløber / Tail x nut / A x I)



701CN

Vandmålerforskruning med NBR pakning
og kort omløber. Rå messing.

Complete brass water meter connection
union with short nut. NBR rubber washer.
Yellow.

Wasserzählerverschraubung mit kurzer
Überwurfmutter und NBR Dichtung. Gelb.

ART. NO.	DIMENSION	VVS	BOX	STATUS
701CN-004	1/2" x 3/4"	48 4970 604	15 / 150	✓

DIM: (nippel x omløber / Tail x nut / A x I)



701CWB

Vandmålerforskruning med omløber og
NBR pakning (GU701). Rå messing med
TEA overfladebelægning

Complete brass water meter connection
union. With NBR rubber washer (GU701).
Yellow with TEA treatment.

Wasserzählerverschraubung mit NBR
Dichtung (GU701). Gelb mit TEA Ober-
fläche.

ART. NO.	DIMENSION	VVS	BOX	STATUS
701CWB-004	1/2" x 3/4"	48 4973 004	15 / 150	✓
701CWB-006	3/4" x 1"	48 4973 006	10 / 100	✓
701CWB-008	1" x 1.1/4"	48 4973 008	10 / 100	✓

DIM: (nippel x omløber / Tail x nut / A x I)



701CRWB

Vandmålerforskruning med NBR pakning.
Afzinkningsfri messing med TEA overflad -
belægning.

Complete brass water meter connection
union. NBR rubber washer. Non dezinci-
fiable all y with TEA treatment.

Wasserzählerverschraubung mit NBR
Dichtung. Korrosionsfeste Messingle-
gierung mit TEA Oberfläche.

ART. NO.	DIMENSION	VVS	BOX	STATUS
701CRWB-010	1.1/4" x 1.1/2"	48 4973 010	5 / 50	✓
701CRWB-011	1.1/2" x 2"	48 4973 011	4 / 40	✓
701CRWB-012	2" x 2.1/2"	48 4973 012	2 / 20	✓

DIM: (nippel x omløber / Tail x nut / A x I)

✓ in stock in Middelfart, X 2-4 weeks



701WM

Vandmålerforskruning med NBR pakning. Kort model. Rå messing.

Complete brass water meter connection union. With NBR rubber washer. Short version. Yellow.

Komplette Wasserzählerverschraubung mit NBR Dichtung. Kurzes modell. Gelb.

ART. NO.	DIMENSION	VVS	BOX	STATUS
701WM-006	3/4" x 1"	48 4901 706	10 / 100	✓

DIM: (nippel x omlober / Tail x nut / A x I)



R701DIN

Nippelende af messing, mufte/nippel til radiatorforskruning art. 701DIN. Rå messing.

Brass tail piece F x M for radiator union Art. 701DIN. Yellow.

Nippelende aus Messing, IG x AG für Heizkörperverschraubung Typ 701DIN. Gelb.

ART. NO.	DIMENSION	VVS	BOX	STATUS
R701DIN-003	3/8" x 1/2"	40 5000 103	30	X
R701DIN-004	1/2" x 3/4"	40 5000 104	30	X
R701DIN-006	3/4" x 1"	40 5000 106	30	✓
R701DIN-008	1" x 1.1/4"	40 5000 108	30	✓

DIM: (mufte x nippel / femail x mail / I x A)



700

Radiatorforskruning, vinkelløbende, mufte/nippel. O-ring på pakfladen. Rå messing.

Three piece elbow radiator union F x M. Metallic seal + O-ring. Yellow.

Heizkörperverschraubung, Eckform, IG x AG. Gelb.

ART. NO.	DIMENSION	VVS	BOX	STATUS
700-003	3/8"	40 5027 003	20 / 200	X
700-004	1/2"	40 5027 004	15 / 150	✓
700-006	3/4"	40 5027 006	20 / 80	✓
700-008	1"	40 5027 008	10 / 40	✓
700-010	1.1/4"	40 5027 010	5 / 20	✓
700-011	1.1/2"	40 5027 011	25	X
700-012	2"	40 5027 012	12	X



701

Radiatorforskruning, ligeløbende, mufte/nippel. O-ring på pakfladen. Rå messing

Three piece straight radiator union F x M. Metallic seal + O-ring. Yellow.

Heizkörperverschraubung, Durchgangsform, IG x AG. Gelb.

ART. NO.	DIMENSION	VVS	BOX	STATUS
701-003	3/8"	40 5026 003	25 / 250	✓
701-004	1/2"	40 5026 004	20 / 200	✓
701-006	3/4"	40 5026 006	25 / 100	✓
701-008	1"	40 5026 008	15 / 60	✓
701-010	1.1/4"	40 5026 010	8 / 32	✓
701-011	1.1/2"	40 5026 011	50	✓
701-012	2"	40 5026 012	30	X



700DIN

Radiatorforskruning, vinkelløbende, mufte/nippel. Metallisk tætning. Rå messing. I henhold til DIN 3842.

Three piece elbow radiator union F x M. Metallic seal. DIN 3842. Yellow.

Heizkörperverschraubung, Eckform, IG x AG. DIN 3842. Gelb.

ART. NO.	DIMENSION	VVS	BOX	STATUS
700DIN-003	3/8"	40 5001 003	20 / 200	✓
700DIN-004	1/2"	40 5001 004	15 / 150	✓
700DIN-006	3/4"	40 5001 006	20 / 80	✓
700DIN-008	1"	40 5001 008	10 / 40	✓



701DIN

Radiatorforskruning, ligeløbende, mufte/nippel. Metallisk tætning. Rå messing. I henhold til DIN 3842.

Three piece straight radiator union F x M. Metallic seal. DIN 3842. Yellow.

Heizkörperverschraubung, Durchgangsform, IG x AG. DIN 3842. Gelb.

ART. NO.	DIMENSION	VVS	BOX	STATUS
701DIN-003	3/8"	40 5000 003	25 / 250	✓
701DIN-004	1/2"	40 5000 004	20 / 200	✓
701DIN-006	3/4"	40 5000 006	25 / 100	✓
701DIN-008	1"	40 5000 008	15 / 60	✓

✓ in stock in Middelfart, X 2-4 weeks



DE-001/DE-003

Nøgle til luftskrue, blank metal. 5 mm.
Key, metal.
Schlüssel für entlüftungsventil, metall, blank.

ART. NO.	WVS	BOX	STATUS
DE-001	40 5516 300	100	✓
DE-003 (kraftig/heavy/Schwer)	40 5529 005	100	✓



DE-002

Nøgle til luftskrue, hvid plast. 5 mm.
Key, white plastic.
Schlüssel für entlüftungsventil, kunststoff, Weiß.

ART. NO.	WVS	BOX	STATUS
DE-002	40 5527 000	100	✓



DE-018/DE-015

Afslutningsprop med O-ring til radiator. Forkromet.
Radiator plug with O-ring, chromium plated.
Abschlußstopfen mit O-ring, verchromt.

ART. NO.	DIMENSION	WVS	BOX	STATUS
DE-018	3/8"	40 5494 303	100	✓
DE-015	1/2"	40 5494 304	100	✓



DE-019/DE-016

Luftskrue med O-ring til radiator. Forkromet.
Radiator air vent with O-ring, chromium plated.
Entlüftungsventil mit O-ring, verchromt.

ART. NO.	DIMENSION	WVS	BOX	STATUS
DE-019	3/8"	40 5524 303	100	✓
DE-016	1/2"	40 5524 304	100	✓



DE-026/DE-044

Luftskrue med O-ring til radiator. Forkromet/hvid.
Radiator air vent with O-ring, turnable, white/chromium plated.
Entlüftungsventil mit O-ring, drehbar, weiss/verchromt.

ART. NO.	DIMENSION	WVS	BOX	STATUS
DE-026	3/8"	40 5526 003	100	✓
DE-044	1/2"	40 5526 004	100	✓



DE-017

Reduktion med O-ring til radiator. Forkromet.
Reduction with O-ring for radiator, chromium plated.
Reduktion mit O-ring, verchromt.

ART. NO.	DIMENSION	WVS	BOX	STATUS
DE-017	3/8" x 1/2"	40 5005 026	100	✓



DE-043

Aftapningsventil med O-ring, drejelig til radiator. Forkromet/hvid.
Radiator drain valve with O-ring, turnable, chromium plated.
Entleerungsventil mit O-ring, drehbar, verchromt.

ART. NO.	DIMENSION	WVS	BOX	STATUS
DE-043	1/2"	40 5622 304	100	✓



DE-069

Afslutningsprop med silikone profilering til radiator. Forkromet.
Plug for radiator, chromium plated.
Abschlußstopfen mit silikonprofilering, verchromt.

ART. NO.	DIMENSION	WVS	BOX	STATUS
DE-069	1/2"	40 5495 354	100	✓

✓ in stock in Middelfart, X 2-4 weeks



DE-071

Luftskrue med silikone profilring til radiator, forkromet.

Radiator air vent, chromium plated.

Entlüftungsventil mit silikonprofilring, verchromt.

ART. NO.	DIMENSION	VVS	BOX	STATUS
DE-071	1/2"	40 5525 354	100	✓



DE-072

Luftskrue med silikone profilring til radiator, drejelig. Forkromet/hvid.

Radiator air vent, turnable, chromium plated.

Entlüftungsventil mit silikon Profilring, drehbar, verchromt.

ART. NO.	DIMENSION	VVS	BOX	STATUS
DE-072	1/2"	40 5526 354	100	✓



DE-088

Aftapningsventil med silikone profilring til radiator, drejelig. Forkromet/hvid.

Drain valve for radiator, turnable, white/chromium plated.

Entleerungsventil mit silikon Profilring, drehbar, verchromt/weiss.

ART. NO.	DIMENSION	VVS	BOX	STATUS
DE-088	1/2"	40 5622 354	100	✓



DE-023

Luftskrue til radiator, forkromet, nøgle.

Radiator air vent (key), chromium plated.

Entlüftungsventil, schlüssel, verchromt.

ART. NO.	DIMENSION	VVS	BOX	STATUS
DE-023	1/8"	40 5512 301	100	✓



DE-VFB

Luftskrue med hjul til radiator, rå messing.

Radiator air vent with wheel, brass.

Entlüftungsventil mit rad, gelbes Messing.

ART. NO.	DIMENSION	VVS	BOX	STATUS
DE-VFB-001	1/8"	40 5501 001	200	✓
DE-VFB-002	1/4"	40 5501 002	100	✓
DE-VFB-003	3/8"	40 5501 003	100	✓
DE-VFB-004	1/2"	40 5501 004	100	✓



NEW



92

Dynamisk strengreguleringsventil "Dynasty" med lineær karakteristik og målerudtag for måling af tryk og temperatur. M x M.

PICV "Dynasty" with linear characteristic and measuring outlet for measuring pressure and temperature. F x F.

Dynamisches Strangregelventil „Dynasty“ mit linearer Kennlinie, zur Messung von Druck und Temperatur. M x M.

ART. NO.	DIMENSION	FLOW	WVS	BOX	STATUS
92VL-004	1/2"	150 l/h	40 7072 104	1	✓
92L-004	1/2"	450 l/h	40 7072 004	1	✓
92H-004	1/2"	850 l/h		1	✓
92L-006	3/4"	1000 l/h		1	✓
92H-006	3/4"	1850 l/h		1	✓
92L-008	1"	2500 l/h		1	✓
92H-008	1"	3300 l/h		1	✓



92X

Dynamisk strengreguleringsventil "Dynasty" med lineær karakteristik. N x N. Inkl. filter indsats.

Dynamic string control valve "Dynasty" with linear characteristic. N x N. Including filter insert.

Dynamisches Strangregelventil „Dynasty“ mit linearer Kennlinie. N x N. Inkl. Filtereinsatz.

ART. NO.	DIMENSION	FLOW	WVS	BOX	STATUS
92XVL/2-004	1/2"	150 l/h		1	✓
92XL/2-004	1/2"	450 l/h		1	✓
92XVL/2-006	3/4"	150 l/h		1	✓
92XL/2-006	3/4"	450 l/h		1	✓
92XVL/2-008	1"	850 l/h		1	✓
92XL/2-008	1"	1000 l/h		1	✓
92XH/2-008	1"	1800 l/h		1	✓



XT702

Presamlet ventil sæt, by-pass (70 mm centerafstand) med dynamisk strengreguleringsventil art.nr. 92 og FilterBall.

PCS preassembled valve kit, flushing by-pass (70 mm interaxis) with PICV 92 Series and FilterBall.

Vormonterter PCS-Ventilsæt, Spülbypass (70 mm Achsenabstand) mit PICV 92-Serie und FilterBall.

ART. NO.	DIMENSION	FLOW	WVS	BOX	STATUS
XT702-004-150	1/2"	150 l/h		1	✓
XT702-004-450	1/2"	450 l/h		1	✓
XT702-006-1000	3/4"	1000 l/h		1	✓
XT702-006-1850	3/4"	1850 l/h		1	✓



XT704

Premonteret ventil sæt, by-pass (70 mm centerafstand) med art. nr. 92 og FilterBall (filter/afspærringsventil). Funktioner: tilslutningssæt med aftapningsventil.

PCS preassembled valve kit, flushing by-pass (70 mm interaxis) with Dynasty 92 Series PICV and FilterBall shut off valve.

Vormonterter Ventil sæt, Spülbypass (70 mm) mit PICV 92-Serie und FilterBall.

ART. NO.	DIMENSION	FLOW	WVS	BOX	STATUS
XT704-004-150	1/2"	150 l/h		1	✓
XT704-004-450	1/2"	450 l/h		1	✓
XT704-006-1000	3/4"	1000 l/h		1	✓
XT704-006-1850	3/4"	1850 l/h		1	✓



XT880

Premonteret ventil sæt, by-pass (80 mm centerafstand) med Dynasty 92, FilterBall filter / afspærringsventil.

PCS Preassembled valve kit, by-pass (80 mm center distance) with Dynasty 92, FilterBall filter / shut-off valve.

Vormonterter Ventil sæt, Bypass (80 mm Mittenabstand) mit Dynasty 92, FilterBall-Filter/Absperrventil.

ART. NO.	DIMENSION	FLOW	WVS	BOX	STATUS
XT880-006-008-2500	3/4" x 1"	2500 l/h		1	✓
XT880-006-008-3300	3/4" x 1"	3300 l/h		1	✓
XT880-008-5200	1" x 1"	5200 l/h		1	✓



XT881

Premonteret ventil sæt, by-pass (80 mm centerafstand) med Dynasty 92 og FilterBall. Funktioner: tilslutningssæt med aftapningsventil og ekstra PT-port.

PCS hydraulic kit with DYNASTY dynamic balancing valve, Filterball, cleaning by-pass, drain valve with venting option and additional pressure taps.

Vormontertes Ventilset.

ART. NO.	DIMENSION	FLOW	WVS	BOX	STATUS
XT881-008-2500	1" x 1"	2500 l/h		1	✓
XT881-008-3300	1" x 1"	3300 l/h		1	✓
XT881-008-5200	1" x 1"	5200 l/h		1	✓

DYNASTY

Den nye Dynasty-serie art. nr. 92 er designet til at give alle fordelene ved den eksisterende PICV-ventilerie med den ekstra fordel at den kan operere i stærkt forurenset vand. Ventilen har en lineær karakteristik, og den er også designet til at blive rengjort, udskiftet og samlet uden at påvirke ventilens ydeevne.

The new **Dynasty** range of PICV has been designed to give all the advantages of the existing PICV valve range with the added benefit of **operating in heavily contaminated water**. The valve has a **Linear characteristic** and it has also been **designed to allow the internals to be removed, clean and replaced** without effecting the performance of the valve.



92VL-92L 1/2"

92H 1/2"

92L-92H 3/4"

92L-92H 1" - 92H 1 1/4"

92H 1 1/2" - 92H 2"

92X/2

FUNKTIONER OG FORDELE FEATURES AND ADVANTAGES

- ✓ Lavt minimumstryk kræves ved opstart
- ✓ LOW MINIMUM PRESSURE required for start-up
- ✓ Termiske aktuatorer og elektromekaniske aktuatorer tilgængelige
- ✓ THERMAL ACTUATORS and ELECTRO MECHANICAL ACTUATORS available
- ✓ Snavsafvisende membran, langtidstestet med 900 PPM jernoxid Fe2O3 (5 microns).
- ✓ DIRT RESISTANT DIAPHRAGM, life-tested according to proprietary **test with dirty water**, constantly contaminated by **900 PPM of Iron Oxide Fe2O3 (5 microns)**.

- ✓ Kompakt ventil
- ✓ COMPACT size
- ✓ Lineær karakteristik
- ✓ LINEAR and Equalpercentage characteristic thru actuator
- ✓ Nem vedligeholdelse
- ✓ EASY maintenance

TEKNISKE SPECIFIKATIONER TECHNICAL SPECIFICATIONS

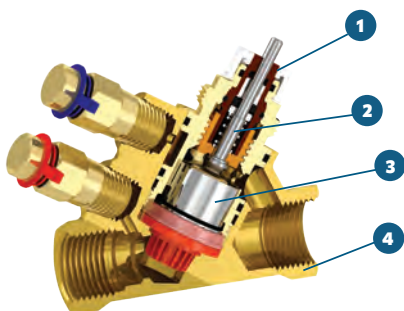

	MATERIALE LIST	Material list
Reguleringsventil (2) Regulating valve (2)	Højtydende polymer, rustfri stål	High performance polymer, stainless steel
Forindstillingsknap (1) Pre-setting knob (1)	ABS + Polycarbonate	ABS + Polycarbonate
Membran (3) Membrane based diaphragm (3)	Højtydende polymer, WMQ silikon, rustfrit	High performance polymer, WMQ silicon, stainless steel, HNBR
Hus (4) Body (4)	Korrosionsbestandig messing CW602N	Corrosion resistant brass CW602N
O-ring O-rings	EPDM-x	EPDM-x

- ✓ INTERN FORUDINDSTILLING med slagreduktion af reguleringsventilen
- ✓ INTERNAL PRESETTING with strike reduction of the control valve

- ✓ TILGÆNGELIG membran for nem vedligeholdelse
- ✓ ACCESSIBLE diaphragm for easy maintenance

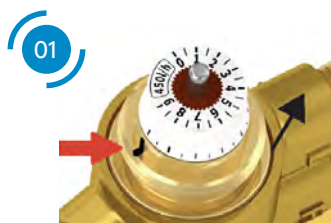

Kvalitetssikring / Quality Guarantee / Qualitätssicherung



Pettinaroli har igennem mange år kvalitetssikret sine produkter: Kvalitetssystemet har siden starten været certificeret af BSI, British Standard Institution og er senest med succes blevet opdateret til ISO 9001:2015. De mange års arbejdet med kvalitetssikring har været medvirkende til den høje produktkvalitet, der kendetegner vort firma. Godkendelser på de enkelte produkter forefindes på www.pettinaroli.dk eller www.pettinaroli.com

At Pettinaroli we have sought third party quality assurance for our products for years: Since 1990 our quality system has been certified by the British Standard Institution. Over the years the system has been successfully updated to ISO 9001:2015. All our efforts in terms of our quality system have certainly contributed to the high quality of our products that characterizes our business. Approvals on single products can be found on www.pettinaroli.dk/en or www.pettinaroli.com.

Seit vielen Jahren streben wir bei Pettinaroli nach DIN-Normen für unsere Produkte: Unser Qualitätssystem ist seit 1990 von der British Standard Institution zertifiziert. Über den Jahren ist das System mit Erfolg auf ISO 9001:2015 zertifiziert. Alle unsere Anstrengungen in Bezug auf unser Qualitätssystem haben zu der hohen Produktqualität unseres Unternehmens beigetragen. Zulassungen für einzelne Produkte sind auf www.pettinaroli.dk/en oder www.pettinaroli.com zu finden.

Tekniske data / Technical Data / Technische Data

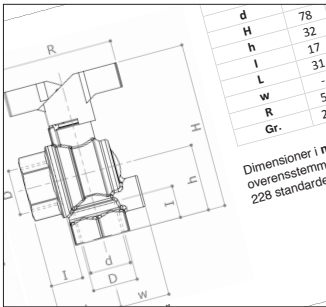

Vedr. tekniske datablade og godkendelser etc. på Pettinaroli kuglehaner og ventiler henviser vi til vores hjemmeside www.pettinaroli.dk.

Concerning technical data sheets and approvals etc. on Pettinarolis complete ball valve range, we refer to our website www.pettinaroli.dk/en.

Technische Datenblätter und Zulassungen der Pettinaroli Kugelhähne und Ventile finden Sie unter www.pettinaroli.dk/en

Salgs- og leveringsbetingelser / Conditions of sales and delivery



Pettinaroli A/S holder sig til de enhver tid gældende almindelige salgs- og leveringsbetingelser for VVS-materiel udstykket af VVS-fabrikantforeningen.

Den komplette tekst for vore salgs- og leveringsbetingelser findes på www.pettinaroli.dk

Pettinaroli A/S sticks to the current general terms and conditions of sales and delivery for plumbing supplies set by plumbing manufacturers association.

The full text of our terms and conditions can be found on www.pettinaroli.dk/en

Pettinaroli hält sich an den aktuellen allgemeinen Verkaufs- und Lieferbedingungen von der Sanitär-Herstellerverband.

Siehe www.pettinaroli.dk/en

Godkendelser / Approvals / Zulassungen



Pettinaroli ventiler godkendes til drikkevand under den danske GDV-ordning eller under den internationale (tyske) DVGW-ordning. Begge typer certifikater kvalificerer produkterne til brug i drikkevandsinstallationer i Danmark.

På www.pettinaroli.dk/godkendelser finder du en oversigt over de udstedte certifikater samt en oversigt over produkter, hvor behandlingen ligger hos myndighederne og certifikat forventes snarest.

Vær opmærksom på, at enkelte produktvarianter/dimensioner kan være friholdt af ansøgning/certificering.

You can find approvals at www.pettinaroli.dk/en/approvals and www.pettinaroli.com

Zulassungen finden Sie unter www.pettinaroli.dk/en/approvals und www.pettinaroli.com.



PETTINAROLI SpA - Italy



PETTINAROLI A/S - Denmark



Her er nogle data, der opsummerer nogle af de tiltag der er foretaget over de senere år i Pettinarolis produktion i Italien. Dette for at begrænse påvirkningerne af vores aktiviteter på det omgivende miljø.

Here is some data that summarizes some of the initiatives taken in recent years in Pettinaroli's production in Italy. To limit the impact of our activities on the surrounding environment.

Hier einige Daten, die einige der Initiativen zusammenfassen, die in den letzten Jahren in Pettinarolis Produktion in Italien ergriffen wurden, um die Auswirkungen unserer Aktivitäten auf die Umgebung zu begrenzen.



Making your work every day easier



PETTINAROLI A/S
Mandal Allé 21 • DK-5500 Middelfart • DENMARK
Tel. +45 6341 0900 • info@pettinaroli.dk • www.pettinaroli.dk
Rev. 04-2025

