

DATRON HIGH-SPEED MILLING TOOLS

Precision. Power. In Aluminium and More...



DATRON

CNC Milling Tools

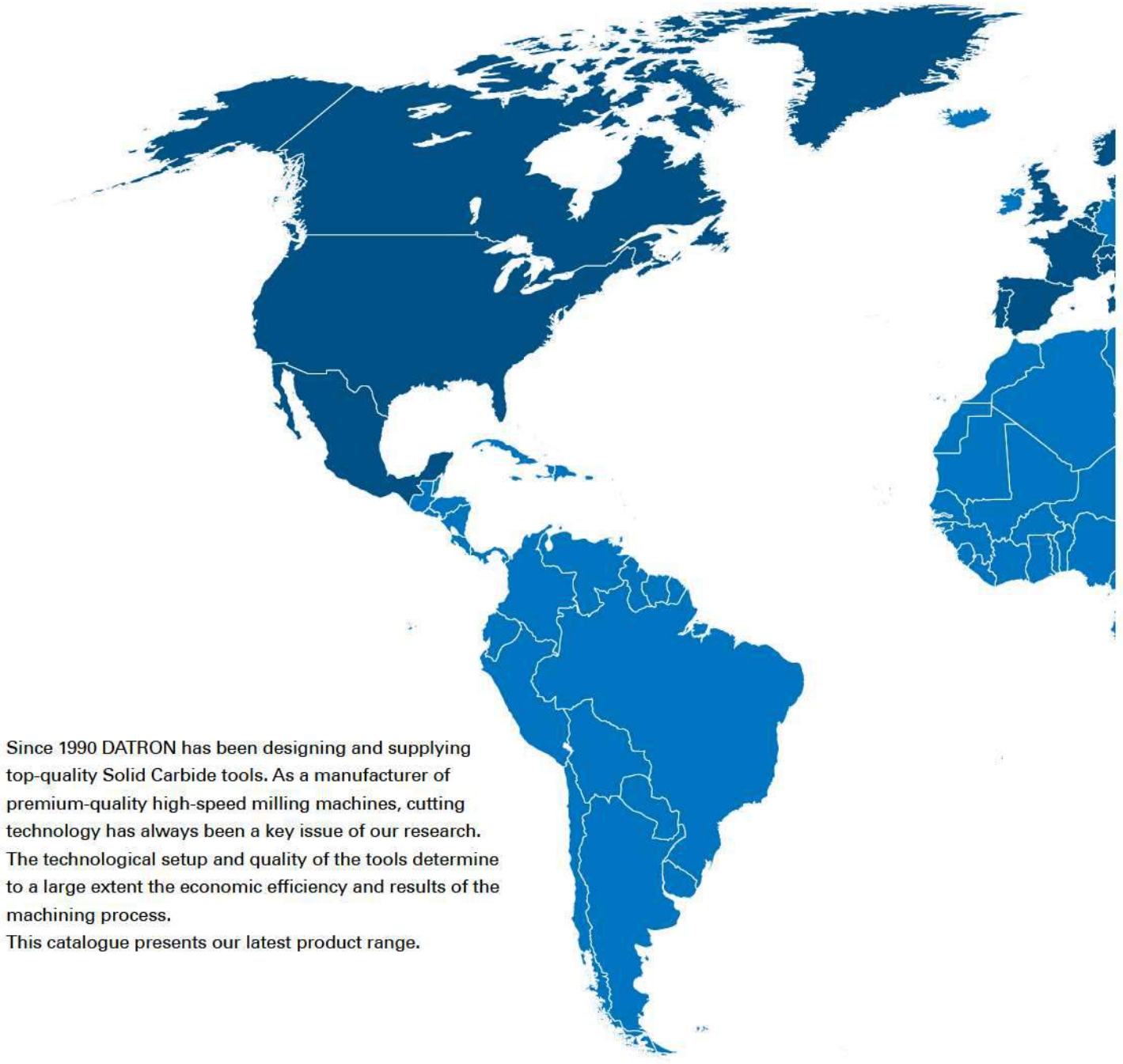

Since 1990 DATRON has been designing and supplying top-quality Solid Carbide tools. As a manufacturer of premium-quality high-speed milling machines, cutting technology has always been a key issue of our research. The technological setup and quality of the tools determine to a large extent the economic efficiency and results of the machining process. This catalogue presents our latest product range.

DATRON has a Worldwide Presence!

To offer you fast delivery, we distribute our milling tools all over the world in cooperation with national and international representatives.

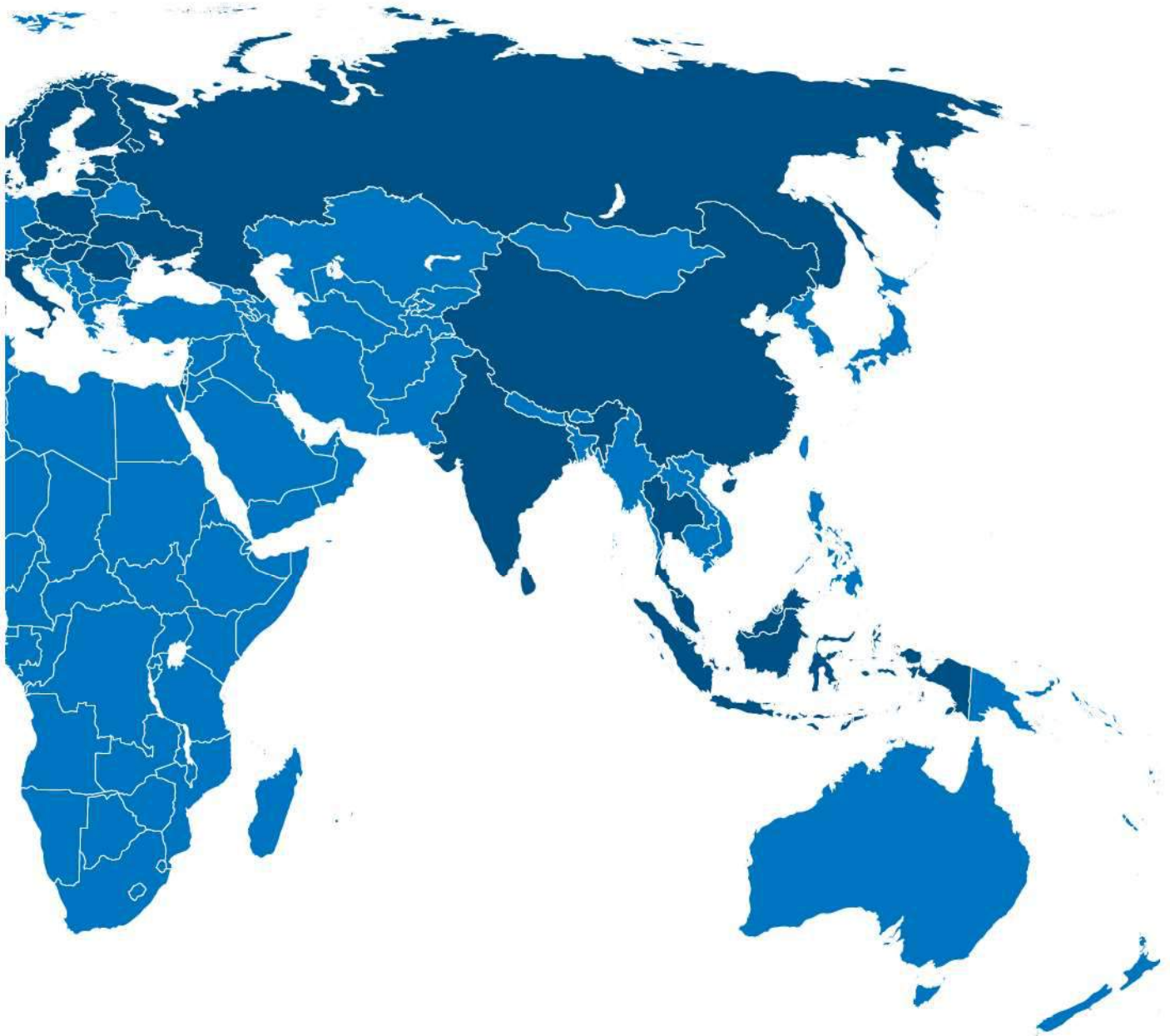

Table of Contents

TOOLS

MATERIAL

Aluminum Copper Bronze Brass Steel Plastic Wood PU Foams



END MILLS

	Single Flute End Mill	++	+	+	+		++	++
	Single Flute End Mill with Coating (ALCRONA)	+		++	+			+
	Single Flute End Mill with Polished Cutting Edge for Acrylic Glass						++	
	Single Flute End Mill with Toric Cut	++	+	+	+		++	++
	Single Flute End Mill, Specially Balanced	++	+	+	+		++	++
	Single Flute End Mill 4-IN-1	++	+	+	+		++	++
	Single Flute End Mill Left Hand Spiral, Right Hand Cutting	++		+	+		++	++
	Double Flute End Mill	++	++	+	++		++	+
	Double Flute End Mill with Toric Cut	++	++	+	++		++	+
	Double Flute End Mill, Contour Milling	++			++		++	+
	Double Flute End Mill HSC+	+	+		+		++	+
	Double Flute End Mill HSC Fire	++			++		+	+
	Double Flute End Mill with Internal Cooling	++	++	+	++		++	++
	Double Flute End Mill for Steel Machining					++	++	
	Triple Flute End Mill, Roughing Mill for Copper		++					
	Triple Flute End Mill, Smoothing Mill for Copper		++					
	Triple Flute End Mill with Toric Cut	+	+		+			++
	Triple Flute End Mill for PU Foam							++
	Triple Flute End Mill with Coating (X.CEED)					++	++	
	Four Flute End Mill with Coating (ALCRONA)					++	++	
	Micro-Toothed End Mill							
	Micro-Toothed End Mill with Coating (X.CEED/Diamond)							
	Diamond Mill for CRP/GRP							

FACE MILLING TOOLS

	Single Flute End Mill, Stepped	++	+		++		+	+
	Double Flute End Mill, Stepped	++	+		++		+	+
	Double Flute End Mill, Stepped with Edge Radius	++	+		++		+	+
	Double Flute End Mill, Stepped with Edge Radius and Polished Flute for Acrylic Glass						++	
	Face Milling Tool Monoblock	++	++	+	++	++	++	+

BALL NOSE END MILLS

	Ball Nose End Mill, One Flute	++		+	+		++	++
	Ball Nose End Mill, One Flute and Polished for Acrylic Glass						++	
	Ball Nose End Mill, Two Flutes	++	++	++	++		++	++
	Ball Nose End Mill, Two Flutes with Toric Cut	++	++	++	++		++	++
	Ball Nose End Mill, Two Flutes with Coating (ALCRONA)					++	++	
	Ball Nose End Mill, Four Flutes with Coating (ALCRONA)					++	++	

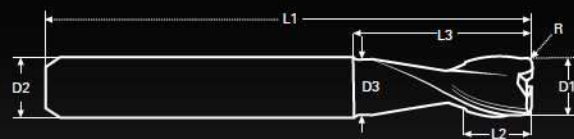

GRP/CRP
Acrylic Glass

GEOMETRY
Number of Flutes

GRP/CRP	Acrylic Glass	GEOMETRY Number of Flutes	D1 (mm)	D2 (mm)	D3 (mm)	L1 (mm)	L2 (mm)	L3 (mm)	R (mm)	Thread Size	A (°)	CT	Page
		1	0.3 - 10.0	3.0 - 10.0	-	38.0 - 100.0	1.0 - 40.0	-	-	-	-	-	12
+		1	2.0 - 6.0	6.0	-	50.0 - 58.0	5.0 - 22.0	-	-	-	-	x	14
	++	1	1.0 - 10.0	6.0 - 10.0	-	50.0 - 75.0	4.0 - 32.0	-	-	-	-	-	15
		1	1.0 - 6.0	6.0	0.9 - 5.3	50.0 - 60.0	4.0 - 14.0	7.0 - 30.0	-	-	-	-	16
		1	5.0 - 12.0	6.0 - 12.0	4.8 - 11.0	50.0 - 85.0	8.5 - 32.5	13.5 - 52.0	-	-	-	-	17
		1	3.0 - 12.0	6.0 - 12.0	2.8 - 11.0	40.0 - 95.0	5.0 - 36.0	13.0 - 61.0	-	-	-	-	18
		1	1.5 - 6.0	6.0	-	50.0 - 60.0	7.0 - 20.0	-	-	-	-	-	20
		2	0.1 - 12.0	3.0 - 12.0	5.7 - 11.7	38.0 - 100.0	0.2 - 40.0	22.0 - 35.0	-	-	-	-	22
		2	0.5 - 6.0	3.0 - 6.0	0.45 - 5.7	38.0 - 60.0	0.75 - 20.0	4.0 - 33.0	-	-	-	-	24
		2	3.0 - 12.0	6.0 - 12.0	-	57.0 - 70.0	8.0 - 25.0	-	-	-	-	-	25
		2	1.5 - 6.0	3.0 - 6.0	-	40.0 - 58.0	4.0 - 12.0	-	-	-	-	-	26
		2	6.0 - 10.0	6.0 - 10.0	-	50.0 - 70.0	12.0 - 32.0	-	-	-	-	-	27
		2	6.0 - 12.0	6.0 - 12.0	5.6 - 11.2	60.0 - 80.0	14.0 - 32.0	32.0 - 48.0	-	-	-	-	28
		2	0.9 - 3.0	3.0	-	38.0	1.1 - 7.0	-	-	-	-	-	29
		3	3.0 - 10.0	6.0 - 10.0	-	50.0 - 60.0	6.0 - 22.0	-	-	-	-	-	30
		3	1.0 - 8.0	6.0 - 8.0	-	50.0	2.2 - 16.0	-	-	-	-	-	31
		3	3.0 - 12.0	6.0 - 12.0	2.8 - 11.8	58.0 - 83.0	8.0 - 26.0	12.0 - 38.0	-	-	-	-	32
		3	3.0 - 10.0	6.0 - 10.0	2.7 - 9.5	50.0 - 115.0	6.0 - 52.0	22.0 - 82.0	-	-	-	-	33
		3	1.75 - 6.0	3.0 - 6.0	-	40.0 - 50.0	3.0 - 10.0	-	-	-	-	x	34
		4	2.0 - 12.0	6.0 - 12.0	-	50.0 - 100.0	7.0 - 45.0	-	-	-	-	x	35
++		8	0.6 - 3.0	3.0 - 3.175	-	38.0	3.0 - 12.0	-	-	-	-	-	36
++		8	0.6 - 6.0	3.0 - 6.0	-	38.0 - 50.0	3.0 - 22.0	-	-	-	-	x	37
++		1-2	3.0 - 10.0	6.0 - 10.0	2.8 - 9.2	50.0 - 60.0	5.0 - 12.0	6.0 - 17.0	-	-	-	x	38
		1	14.0 - 24.0	8.0 - 12.0	-	45.0 - 60.0	5.0 - 8.5	-	-	-	-	-	40
		2	8.0 - 20.0	6.0 - 12.0	-	50.0 - 82.0	6.0 - 10.0	-	-	-	-	-	41
		2	12.0 - 20.0	6.0 - 8.0	-	50.0	6.0 - 8.0	-	0.5	-	-	-	42
	++	2	10.0 - 16.0	6.0 - 8.0	-	50.0	6.0	-	1.0	-	-	-	43
		2	20.0 - 24.0	-	18.5 - 22.5	-	10.0	38.0 - 63.0	0.8	-	-	-	44
		1	1.0 - 10.0	3.0 - 10.0	-	40.0 - 60.0	4.0 - 20.0	-	0.5 - 5.0	-	-	-	46
	++	1	1.0 - 6.0	6.0	0.9 - 5.8	50.0	4.0 - 14.0	12.0 - 22.0	0.5 - 2.5	-	-	-	47
		2	0.3 - 8.0	3.0 - 8.0	-	39.0 - 50.0	0.5 - 12.0	-	0.15 - 4.0	-	-	-	48
		2	0.4 - 12.0	3.0 - 12.0	0.35 - 11.7	39.0 - 100.0	0.6 - 20.0	2.0 - 40.0	0.2 - 6.0	-	-	-	49
		2	0.4 - 3.0	3.0	-	38.0 - 39.0	1.2 - 6.0	-	0.2 - 1.25	-	-	-	50
		4	2.0 - 12.0	6.0 - 12.0	-	57.0 - 100.0	6.0 - 45.0	-	1.0 - 6.0	-	-	-	51

Table of Contents



TOOLS

MATERIAL



Aluminum Copper Bronze Brass Steel Plastic Wood PU Foams



TORIC END MILLS

	Double Flute End Mill with Edge Radius	++	+		++		+	+
	Double Flute End Mill with Edge Radius and Coating (Triple-Cut)	++	+		++		+	+
	Four Flute End Mill with Edge Radius and Coating (X.CEED)						++	
	Four Flute End Mill with Double Radius and Coating (X.CEED)						++	

COUNTERSINK TOOLS

	Countersink Tool	++		+	+		++	++
	Countersink Tool for Acrylic glass						++	
	Countersink Tool for PU Foam							++
	Milling Countersink Tool	++		+	+		++	++
	V-Slotting Mill	++		+	+		++	++

DRILLS

	Drill, 3mm Shank	++	++	++	++	+	++	+
	Drill, 1/8" Shank	++	++	++	++	+	++	+
	Drill, 6mm Shank	++	++	++	++		++	+

THREAD MILLS

	Thread Mill	++	++	++	++	+	++	+
	Milling Thread Mill	++	+		++		++	+
	Multi Thread Mill	++			++		++	

EXTERNAL RADIUS END MILLS

	External Radius End Mill	++		+	+		++	++
	External Radius End Mill, Polished for Acrylic Glass						++	
	Deburring End Mill, Two Flutes						++	

STANDARD ENGRAVING TOOLS

	Standard Engraving Tool	++	++	++	++		++	+
	Standard Engraving Tool, Specialty Balanced	++	++	++	++		++	+
	Standard Engraving Tool for Steel Machining						++	
	Standard Engraving Tool for Hard-Metal Machining with Coating (ALCRONA)			+			++	

T-SLOTTING MILLS

	T-Slotting Mills	++		+	+		++	++
--	------------------	----	--	---	---	--	----	----

DOVETAIL MILLING TOOLS

	Dovetail Milling Tool	++		+	+		++	++
--	-----------------------	----	--	---	---	--	----	----



GRP/CRP	Acrylic Glass	GEOMETRY Number of Flutes	D1 (mm)	D2 (mm)	D3 (mm)	L1 (mm)	L2 (mm)	L3 (mm)	R (mm)	Thread Size	A (°)	CT	Page
		2	6.0 - 8.0	6.0 - 8.0	5.8 - 7.8	50.0 - 60.0	6.0 - 12.0	21.0 - 23.0	0.2 - 1.0	-	-	-	54
		2	3.0 - 10.0	3.0 - 10.0	2.7 - 9.2	50.0 - 72.0	4.0 - 11.0	14.0 - 32.0	0.3 - 1.0	-	-	x	55
		4	2.0 - 10.0	6.0 - 10.0	1.8 - 9.2	50.0 - 72.0	4.0 - 11.0	12.0 - 32.0	0.2 - 1.0	-	-	x	56
		4	3.0 - 6.0	6.0	-	50.0	1.0	-	0.8	-	-	x	57
		2 - 4	3.0 - 14.0	3.0 - 10.0	-	40.0 - 50.0	1.1 - 8.2	-	-	-	40 - 140	-	60
	+	3/6	0.1 - 4.0	6.0	6.0 - 16.0	50.0	3.0 - 6.0	-	-	-	90	-	61
		3	4.0	6.0	10.0 - 16.0	50.0	3.0 - 6.0	-	-	-	90	-	62
		1	2.0 - 5.0	6.0	-	50.0	1.0 - 5.0	-	-	-	90	-	63
		2	5.0 - 8.0	6.0 - 10.0	-	50.0 - 70.0	10.0 - 16.0	-	-	-	60 - 120	-	64
		2	0.15 - 6.5	3.0	-	38.0	2.0 - 12.0	-	-	-	130	-	66
		2	0.15 - 6.5	3.175	-	38.0	1.0 - 12.0	-	-	-	130 - 165	-	68
		2	3.0 - 6.0	6.0	-	50.0 - 60.0	21.0 - 31.0	-	-	-	130	-	70
	+	4	0.8 - 8.0	3.0 - 6.0	0.49 - 3.0	40.0 - 60.0	0.09 - 1.55	3.0 - 30.0	-	M1 - M10 PG7 - PG48 Whitworth < 1/2"	55 - 80	-	73
		3	2.0 - 5.6	3.0 - 6.0	1.5 - 5.4	40.0 - 50.0	1.0 - 2.0	8.5 - 12.0	-	M2.5 - M16 PG7 - PG48	60 - 80	-	74
		k.A.	2.3 - 6.0	6.0 - 10.0	-	50.0	8.0 - 16.0	-	-	M3 - M8	60	-	75
		2/4	2.0 - 5.0	6.0	6.0 - 16.0	50.0	0.5 - 6.0	-	0.5 - 6.0	-	-	-	78
	+	3	4.0 - 5.0	6.0	6.0 - 10.0	50.0	1.0 - 3.0	-	1.0 - 3.0	-	-	-	79
		2	0.8 - 2.4	3.0	-	40.0	0.3	-	0.3	-	-	-	80
	+	1	0.05 - 6.0	4.0 - 6.0	-	40.0 - 50.0	-	-	-	-	20 - 180	-	82
	+	1	0.1	6.0	-	50.0	-	-	-	-	30 - 90	-	84
		1	0.1 - 0.2	6.0	-	50.0	-	-	-	-	20 - 90	-	85
	+	1	0.1 - 0.2	4.0	-	40.0	-	-	-	-	30 - 45	-	86
		2 - 6	3.0 - 15.0	3.0 - 6.0	1.6 - 6.0	40.0 - 50.0	0.8 - 4.5	6.0 - 25.0	-	-	-	-	88
		2	3.0 - 6.0	3.0 - 6.0	2.0 - 5.0	39.0 - 50.0	0.29 - 6.0	6.0	-	-	5 - 60	-	90

Why Single Flute End Mills?	8
Table of Abbreviations	10
HSK Clamping System	
Polygon Clamping Technology	92
DATRON HSK-E Collets	93
DATRON Clamping Device	94
DATRON Reduction Inserts	94

Direct Clamping System	
DATRON Adapter Collets	95
DATRON Insertion Tools and Limit Stop Rings	95
Expendable Material	
VacuCard	98
Cooling Lubricants	100

General Information	
Tool Technology	104
Coatings	105
Guide Values for Speed and Feed	106
CCT	107
Individual Tools	107

DATRON

Single Flute End Mills

When high cutting performance and surface quality are required for machining light metal or plastics, single flute end mills give you a clear advantage. Yet they often face user resentments. In a joint scientific research project, DATRON and the PTW (Institute of Production Management, Technology and Machine Tools) of the TU Darmstadt have been able to dispel those concerns.

The benefits of single flute end mills, especially those with the patented DATRON counter-balanced tip have become obvious.

Single Flute End Mills are Best

When increased demands are made on machining quality, while also requiring high cutting volumes, the single flute end mill is superior to double flute tools, which our customers widely confirm. During the PTW testing, Aluminium parts milled with single and double flute solid carbide ball nose tools were examined under identical circumstances.

Significantly Improved Roughness

The result: On the workpiece the single flute end mill created regular feed marks, a signal for stable machining. In contrast, uneven tool traces of a double flute end mill are proof of lower surface quality. Surface roughness values confirm this: After machining with the double flute end mill, the values for SR were 60% and for Rz 50% higher than those achieved with the single flute end mill.

Optimal Chip Removal Increases Speed and Quality

The explanation for this is relatively simple: To combine the goals of achieving the greatest cutting volume in the shortest time possible during roughing, plus a high surface quality during finishing, several requirements have to be met. Chip formation and removal through the chip channel of the tool have to be designed optimally, taking into account both the material and the machining process. For this purpose, the geometrically conditioned single flute end mill offers clear advantages over multi flute tools when machining soft materials.

Counter-Balanced Tip Allows Higher Speeds

The "icing on the cake," is provided by the DATRON patented counter-balanced tip. Compared to unbalanced single flute end mills, the vibration velocity at the machine's resonance peak can decrease by more than 50%.

At higher speeds, the advantage of single flute end mills is around 50% (according to the test). Conversely, this means: The stable cutting speed range becomes significantly greater.











Put it to the Test: A Single Flute – Many Advantages!



DATRON

Table of Abbreviations

Legend

 Machinable Materials	 Ball Nose	 Shank Form
 Number of Flutes	 Flute with Edge Radius	 Point Angle
 Hardness Grade	 Sharp-Edged Flute	 Spiral Angle
 Solid Carbide	 Feed Direction	

D1	Flute Diameter
D2	Shank Diameter
D3	Toric Cut Diameter
L1	Total Length
L2	Flute Length
L3	Usable Length
α	Angle
R	Radius
BS	Coating

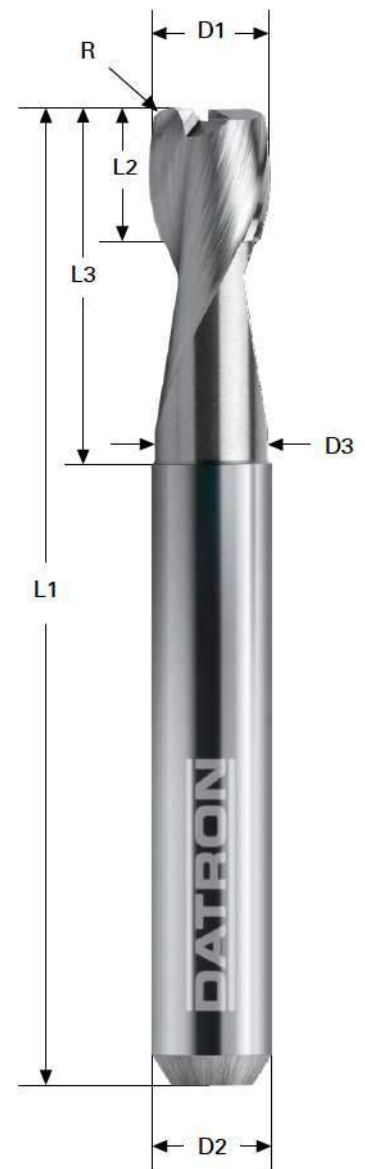

DATRON

End Mills

Single Flute End Mill	12	Triple Flute End Mill, Roughing Mill for Copper	30
Single Flute End Mill with Coating (ALCRONA)	14	Triple Flute End Mill, Smoothing Mill for Copper	31
Single Flute End Mill with Polished Cutting Edge for Acrylic Glass	15	Triple Flute End Mill with Toric Cut	32
Single Flute End Mill with Toric Cut	16	Triple Flute End Mill with polished Flute for PU Foam	33
Single Flute End Mill Specially Balanced	17	Triple Flute End Mill with Coating (X.CEED)	34
Single Flute End Mill 4-IN-1	18	Four Flute End Mill with Coating (ALCRONA)	35
Single Flute End Mill Left Hand Spiral, Right Hand Cutting	20	Micro-Toothed End Mill	36
Double Flute End Mill	22	Micro-Toothed End Mill with Coating (X.CEED/Diamond)	37
Double Flute End Mill with Toric Cut	24	Diamond Mill for CRP/GRP	38
Double Flute End Mill, Contour Milling	25		
Double Flute End Mill HSC+	26		
Double Flute End Mill HSC Fire	27		
Double Flute End Mill with Internal Cooling	28		
Double Flute End Mill for Steel Machining	29		



DATRON

Single Flute End Mill

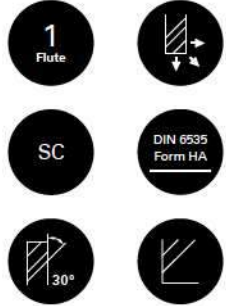
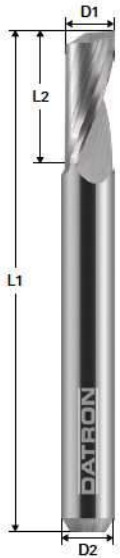

Aluminium



Plastic



Wood



Copper



Bronze



Brass



3 mm Shank

Art. No.	D1 (mm)	D2 (mm)	L1 (mm)	L2 (mm)
0068003E	0.3	3.0	38.0	1.0
0068004E	0.4	3.0	38.0	1.0
0068005E	0.5	3.0	38.0	1.5
0068006E	0.6	3.0	38.0	2.5
0068008E	0.8	3.0	38.0	3.0
0068010E	1.0	3.0	38.0	4.0
0068015E	1.5	3.0	38.0	5.0
0068016E	1.6	3.0	38.0	5.0
0068020G	2.0	3.0	40.0	6.0
0068020E	2.0	3.0	40.0	8.0
0068020L	2.0	3.0	40.0	10.0
0068020W	2.0	3.0	65.0	15.0
0068024A	2.4	3.0	40.0	5.5
0068024E	2.4	3.0	40.0	8.0
0068024L	2.4	3.0	40.0	10.0
0068030E	3.0	3.0	40.0	10.0
0068030Y	3.0	3.0	65.0	10.0
0068030Z	3.0	3.0	40.0	10.5
0068030W	3.0	3.0	65.0	15.0

1/8" Shank

Art. No.	D1 (mm)	D2 (mm)	L1 (mm)	L2 (mm)
0068606E	0.6	3.175	38.0	3.0
0068608E	0.8	3.175	38.0	3.0
0068610E	1.0	3.175	38.0	3.0
0068612E	1.2	3.175	38.0	4.0
0068615E	1.5	3.175	38.0	4.0
0068620G	2.0	3.175	40.0	5.0
0068620E	2.0	3.175	38.0	8.0
0068620F	2.0	3.175	40.0	11.5
0068624E	2.4	3.175	38.0	8.0
0068630E	3.0	3.175	38.0	9.0
0068630F	3.0	3.175	40.0	11.5

4 mm Shank

Art. No.	D1 (mm)	D2 (mm)	L1 (mm)	L2 (mm)
0068415Y	1.5	4.0	40.0	5.0
0068432Y	2.0	4.0	40.0	8.0
0068430Y	3.0	4.0	40.0	10.0
0068434Y	4.0	4.0	40.0	10.0

6 mm Shank

Art. No.	D1 (mm)	D2 (mm)	L1 (mm)	L2 (mm)
0068410E	1.0	6.0	50.0	4.0
0068415A	1.5	6.0	50.0	3.0
0068415E	1.5	6.0	50.0	7.0
0078415E	1.5	6.0	58.0	7.0
0068432A	2.0	6.0	50.0	5.0
0068432E	2.0	6.0	50.0	7.0
0078420E	2.0	6.0	58.0	7.0
0068432L	2.0	6.0	50.0	11.0
0078424E	2.4	6.0	50.0	8.0
0068425A	2.5	6.0	50.0	5.0
0078425E	2.5	6.0	58.0	8.0
0068430A	3.0	6.0	50.0	5.0
0068430E	3.0	6.0	50.0	8.0
0078430E	3.0	6.0	58.0	8.0
0068430S	3.0	6.0	50.0	10.0
0078430S	3.0	6.0	58.0	10.0
0068430L	3.0	6.0	50.0	12.0
0078435E	3.5	6.0	58.0	10.0
0068434A	4.0	6.0	50.0	5.0
0068434B	4.0	6.0	50.0	7.0
0068434E	4.0	6.0	50.0	10.0
0078440E	4.0	6.0	58.0	10.0
0068434L	4.0	6.0	50.0	12.0
0068434Z	4.0	6.0	45.0	14.0
0068434S	4.0	6.0	60.0	14.0
0078440L	4.0	6.0	58.0	18.0
0068434F	4.0	6.0	58.0	20.0
0068435B	5.0	6.0	50.0	8.0
0068435E	5.0	6.0	50.0	12.0
0068435L	5.0	6.0	58.0	22.0
0068460C	6.0	6.0	50.0	8.0
0068460E	6.0	6.0	50.0	14.0
0068460L	6.0	6.0	60.0	20.0
0068460A	6.0	6.0	58.0	25.0
0068460B	6.0	6.0	65.0	30.0

8 mm Shank

Art. No.	D1 (mm)	D2 (mm)	L1 (mm)	L2 (mm)
0068079E	7.0	8.0	60.0	14.0
0068080E	8.0	8.0	60.0	14.0
0068080L	8.0	8.0	60.0	20.0
0068080A	8.0	8.0	60.0	25.0
0068080B	8.0	8.0	80.0	32.0

10 mm Shank

Art. No.	D1 (mm)	D2 (mm)	L1 (mm)	L2 (mm)
0068470E	10.0	10.0	60.0	20.0
0068470L	10.0	10.0	100.0	40.0

DATRON

Single Flute End Mill with Coating (ALCRONA)

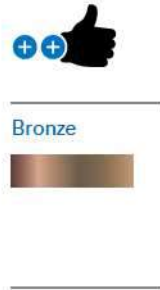
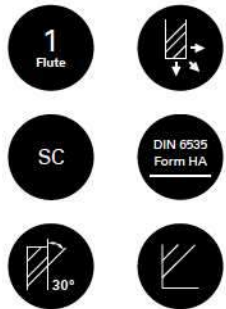

6 mm Shank

Art. No.	D1 (mm)	D2 (mm)	L1 (mm)	L2 (mm)
0068932A	2.0	6.0	50.0	5.0
0068932E	2.0	6.0	50.0	7.0
0068930E	3.0	6.0	50.0	8.0
0068930S	3.0	6.0	50.0	10.0
0068930L	3.0	6.0	50.0	12.0
0068934E	4.0	6.0	50.0	10.0
0068934S	4.0	6.0	50.0	14.0
0068934L	4.0	6.0	58.0	20.0
0068935E	5.0	6.0	50.0	12.0
0068935L	5.0	6.0	58.0	22.0
0068960E	6.0	6.0	50.0	14.0
0068960L	6.0	6.0	58.0	20.0

DATRON

Single Flute End Mill with Polished Cutting Edge for Acrylic Glass

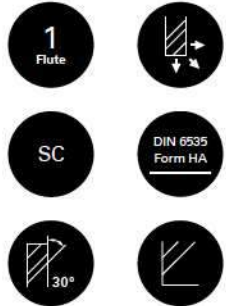
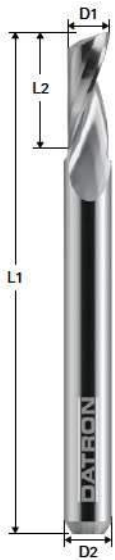

Acrylic Glass



Plastic



Art. No.	D1 (mm)	D2 (mm)	L1 (mm)	L2 (mm)
0078310E	1.0	6.0	50.0	4.0
0078320E	2.0	6.0	50.0	7.0
0078320L	2.0	6.0	50.0	11.0
0078330E	3.0	6.0	50.0	8.0
0078330L	3.0	6.0	50.0	12.0
0078334E	4.0	6.0	50.0	10.0
0078334L	4.0	6.0	60.0	22.0
0078335E	5.0	6.0	50.0	12.0
0078335L	5.0	6.0	60.0	22.0
0078360E	6.0	6.0	50.0	14.0
0078360L	6.0	6.0	60.0	22.0
0078338E	8.0	8.0	60.0	22.0
0078338L	8.0	8.0	70.0	32.0
0078338E	10.0	10.0	75.0	32.0

DATRON

Single Flute End Mill with Toric Cut

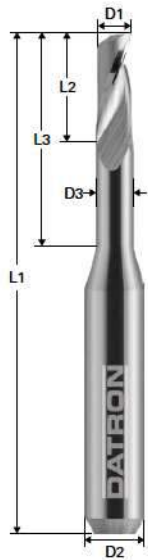

- 1 Flute
- SC
- DIN 6535 Form HA
- 30°

Aluminium

Wood

Plastic

Copper

Brass

Bronze

6 mm Shank

Art. No.	D1 (mm)	D2 (mm)	D3 (mm)	L1 (mm)	L2 (mm)	L3 (mm)
00684910	1.0	6.0	0.9	50.0	4.0	7.0
00684915	1.5	6.0	1.4	50.0	7.0	11.0
0068492K	2.0	6.0	1.8	50.0	4.0	12.0
0068492E	2.0	6.0	1.8	50.0	7.0	14.0
0068493K	3.0	6.0	2.7	50.0	4.0	14.0
0068493E	3.0	6.0	2.7	50.0	8.0	14.0
0068493D	3.0	6.0	2.7	50.0	4.0	17.0
0068493S	3.0	6.0	2.7	50.0	8.0	17.0
0068493F	3.0	6.0	2.7	50.0	4.0	21.0
0068493L	3.0	6.0	2.7	50.0	8.0	21.0
0068494K	4.0	6.0	3.6	50.0	5.0	18.0
0068494E	4.0	6.0	3.6	50.0	10.0	18.0
0068494D	4.0	6.0	3.6	50.0	5.0	21.0
0068494S	4.0	6.0	3.6	50.0	10.0	21.0
0068495K	5.0	6.0	4.4	60.0	5.0	22.0
0068495E	5.0	6.0	4.4	50.0	12.0	22.0
0068496K	6.0	6.0	5.3	60.0	5.0	24.0
0068496E	6.0	6.0	5.3	50.0	14.0	24.0
0068496F	6.0	6.0	5.3	60.0	5.0	30.0
0068496L	6.0	6.0	5.3	60.0	14.0	30.0

DATRON

Single Flute End Mill Specially Balanced

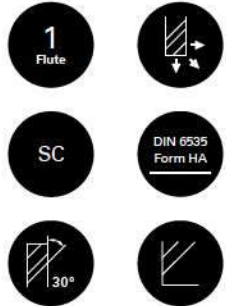

Aluminium Wood



Plastic



Copper Brass



Bronze



6 mm Shank

Art. No.	D1 (mm)	D2 (mm)	D3 (mm)	L1 (mm)	L2 (mm)	L3 (mm)
0068085E	5.0	6.0	4.8	50.0	8.75	13.5
0068086E	6.0	6.0	5.5	50.0	10.5	16.5
0068086L	6.0	6.0	5.5	50.0	16.0	23.5
0068086X	6.0	6.0	5.5	55.0	21.0	27.0

8 mm Shank

Art. No.	D1 (mm)	D2 (mm)	D3 (mm)	L1 (mm)	L2 (mm)	L3 (mm)
0068085S	5.0	8.0	4.8	50.0	8.75	13.5
0068086S	6.0	8.0	5.5	50.0	10.5	16.5
0068088K	8.0	8.0	7.4	50.0	8.0	12.5
0068088E	8.0	8.0	7.4	60.0	14.0	26.0
0068088S	8.0	8.0	7.4	60.0	21.0	31.0
0068088L	8.0	8.0	7.4	60.0	26.0	34.0
0068080D	8.0	8.0	7.4	70.0	14.0	43.0
0068088X	8.0	8.0	7.4	70.0	31.0	42.0

10 mm Shank

Art. No.	D1 (mm)	D2 (mm)	D3 (mm)	L1 (mm)	L2 (mm)	L3 (mm)
0068090K	10.0	10.0	9.2	50.0	10.0	15.6
0068090E	10.0	10.0	9.2	60.0	17.5	27.5
0068090L	10.0	10.0	9.2	60.0	26.0	34.0
0068090M	10.0	10.0	9.2	85.0	26.0	34.0
0068090X	10.0	10.0	9.2	70.0	32.5	42.5
0068090S	10.0	10.0	9.2	80.0	17.5	52.0

12 mm Shank

Art. No.	D1 (mm)	D2 (mm)	D3 (mm)	L1 (mm)	L2 (mm)	L3 (mm)
0068092K	12.0	12.0	11.0	60.0	12.0	19.0
0068092E	12.0	12.0	11.0	70.0	21.0	33.0
0068092L	12.0	12.0	11.0	70.0	31.5	42.0

DATRON

Single Flute End Mill 4-IN-1, Balanced, Wiper Flat, Twice Polished

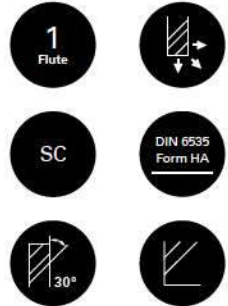
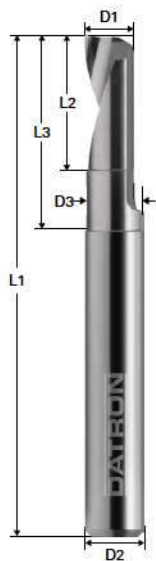

Aluminium Wood



Plastic



Copper Brass



Bronze



6 mm Shank

Art. No.	D1 (mm)	D2 (mm)	D3 (mm)	L1 (mm)	L2 (mm)	L3 (mm)
0068803A	3.0	6.0		40.0	5.0	
0068803K	3.0	6.0		45.0	9.0	
0068803E	3.0	6.0	2.8	50.0	9.0	13.0
0068803L	3.0	6.0	2.8	50.0	9.0	16.0
0068803X	3.0	6.0		50.0	13.0	
0068804A	4.0	6.0		40.0	5.0	
0068804K	4.0	6.0		45.0	9.0	
0068804E	4.0	6.0	3.7	50.0	9.0	16.0
0068804L	4.0	6.0	3.7	55.0	9.0	21.0
0068804X	4.0	6.0		55.0	16.0	
0068805A	5.0	6.0		45.0	7.0	
0068805K	5.0	6.0		50.0	11.0	
0068805E	5.0	6.0	4.6	60.0	11.0	21.0
0068805L	5.0	6.0	4.6	60.0	11.0	26.0
0068805X	5.0	6.0		55.0	16.0	
0068806A	6.0	6.0		45.0	7.0	
0068806K	6.0	6.0		50.0	13.0	
0068806E	6.0	6.0	5.5	60.0	13.0	26.0
0068806L	6.0	6.0	5.5	65.0	13.0	31.0
0068806X	6.0	6.0		55.0	21.0	

8 mm Shank

Art. No.	D1 (mm)	D2 (mm)	D3 (mm)	L1 (mm)	L2 (mm)	L3 (mm)
0068808A	8.0	8.0		45.0	9.0	
0068808K	8.0	8.0		55.0	17.0	
0068808E	8.0	8.0	7.4	65.0	17.0	31.0
0068808L	8.0	8.0	7.4	75.0	17.0	41.0
0068808X	8.0	8.0		65.0	26.0	

10 mm Shank

Art. No.	D1 (mm)	D2 (mm)	D3 (mm)	L1 (mm)	L2 (mm)	L3 (mm)
0068810A	10.0	10.0		50.0	11.0	
0068810K	10.0	10.0		60.0	21.0	
0068810E	10.0	10.0	9.2	75.0	21.0	41.0
0068810L	10.0	10.0	9.2	85.0	21.0	51.0
0068810X	10.0	10.0		70.0	32.0	

12 mm Shank

Art. No.	D1 (mm)	D2 (mm)	D3 (mm)	L1 (mm)	L2 (mm)	L3 (mm)
0068812A	12.0	12.0		55.0	14.0	
0068812K	12.0	12.0		65.0	26.0	
0068812E	12.0	12.0	11.0	85.0	26.0	51.0
0068812L	12.0	12.0	11.0	95.0	26.0	61.0
0068812X	12.0	12.0		75.0	36.0	

DATRON

Single Flute End Mill Left Hand Spiral, Right Hand Cutting

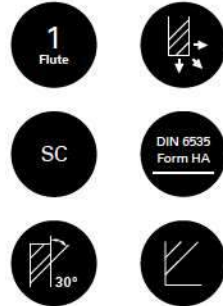
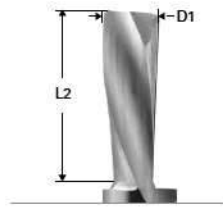

Aluminium



Plastic



Wood



Bronze



Brass



6 mm Shank

Art. No.	D1 (mm)	D2 (mm)	L1 (mm)	L2 (mm)
0068471E	1.5	6.0	50.0	7.0
0068472E	2.0	6.0	50.0	7.0
0068473E	3.0	6.0	50.0	8.0
0068474E	4.0	6.0	50.0	10.0
0068475E	5.0	6.0	50.0	12.0
0068476E	6.0	6.0	50.0	14.0
0068476L	6.0	6.0	60.0	20.0

DATRON

Double Flute End Mill

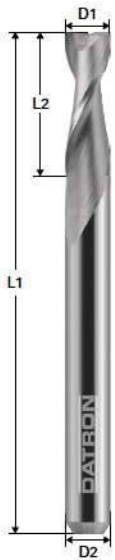

- 2 Flutes
- SC
- 30°
- DIN 6535 Form HA



Aluminium



Copper



Brass



Plastic



Bronze



Wood



3 mm Shank

Art. No.	D1 (mm)	D2 (mm)	L1 (mm)	L2 (mm)
00680010	0.1	3.0	38.0	0.2
00680020	0.2	3.0	39.0	0.4
00680025	0.25	3.0	39.0	0.4
0068003	0.3	3.0	39.0	0.9
0068004K	0.4	3.0	38.0	0.6
0068004	0.4	3.0	38.0	2.5
0068005K	0.5	3.0	38.0	1.0
0068005	0.5	3.0	38.0	2.5
0068006K	0.6	3.0	38.0	1.0
0068006	0.6	3.0	38.0	3.0
0068008	0.8	3.0	38.0	4.0
0068009	0.9	3.0	38.0	5.0
0068010S	1.0	3.0	38.0	2.3
0068010K	1.0	3.0	38.0	3.0
0068010	1.0	3.0	38.0	5.0
0068010L	1.0	3.0	40.0	8.0
0068012S	1.2	3.0	38.0	2.3
0068012K	1.2	3.0	38.0	3.0
0068012	1.2	3.0	38.0	5.0
0068015	1.5	3.0	38.0	5.0
0068015S	1.5	3.0	38.0	10.0
0068016	1.6	3.0	38.0	6.0
0068020K	2.0	3.0	38.0	4.0
0068020	2.0	3.0	38.0	9.0
0068024K	2.4	3.0	38.0	5.0
0068024	2.4	3.0	40.0	8.0
0068030K	3.0	3.0	40.0	6.0
0068030A	3.0	3.0	40.0	10.0
0068030L	3.0	3.0	40.0	12.0
0068030X	3.0	3.0	60.0	25.0

1/8" Shank

Art. No.	D1 (mm)	D2 (mm)	D3 (mm)	L1 (mm)	L2 (mm)	L3 (mm)
0068604	0.4	3.175		38.0	2.5	
0068605	0.5	3.175		38.0	3.0	
0068606	0.6	3.175		38.0	3.0	
0068608	0.8	3.175		38.0	5.0	
0068609	0.9	3.175		38.0	5.0	
0068610K	1.0	3.175		38.0	3.0	
0068610	1.0	3.175		38.0	4.0	
0068612	1.2	3.175		38.0	5.0	
0068613	1.3	3.175		38.0	5.0	
0068615	1.5	3.175		38.0	6.0	
0068616	1.6	3.175		38.0	6.0	
0068617	1.7	3.175		38.0	6.0	
0068618	1.8	3.175		38.0	6.0	
0068620K	2.0	3.175		38.0	4.0	
0068620	2.0	3.175		38.0	8.0	
0068624K	2.4	3.175		38.0	5.0	
0068624	2.4	3.175		38.0	8.0	
0068625	2.5	3.175		38.0	8.0	
0068630K	3.0	3.175		38.0	6.0	
0068630	3.0	3.175		38.0	10.0	

6 mm Shank

Art. No.	D1 (mm)	D2 (mm)	D3 (mm)	L1 (mm)	L2 (mm)	L3 (mm)
0068430K	3.0	6.0		40.0	6.0	
0068430	3.0	6.0		50.0	7.0	
0068430G	3.0	6.0		50.0	11.0	
0068434K	4.0	6.0		40.0	6.0	
0068434	4.0	6.0		50.0	8.0	
0068435K	5.0	6.0		40.0	6.0	
0068435A	5.0	6.0		50.0	8.0	
0068435	5.0	6.0		50.0	10.0	
0068460Y	6.0	6.0		40.0	6.0	
0068460K	6.0	6.0		50.0	10.0	
0078806	6.0	6.0	5.7	60.0	10.0	22.0
0068460	6.0	6.0		50.0	18.0	
0068460G	6.0	6.0		58.0	20.0	
0068460X	6.0	6.0		75.0	30.0	
0068460W	6.0	6.0		75.0	40.0	
0068460Z	6.0	6.0		100.0	40.0	

8 mm Shank

Art. No.	D1 (mm)	D2 (mm)	D3 (mm)	L1 (mm)	L2 (mm)	L3 (mm)
0078808	8.0	8.0	7.7	60.0	10.0	24.0
0068081	8.0	8.0		63.0	16.0	
0068081L	8.0	8.0		60.0	32.0	
0068082	8.0	8.0		100.0	40.0	

10 mm Shank

Art. No.	D1 (mm)	D2 (mm)	D3 (mm)	L1 (mm)	L2 (mm)	L3 (mm)
0068100	10.0	10.0		40.0	10.0	
0078810	10.0	10.0	9.7	50.0	10.0	20.0
0078810L	10.0	10.0	10.0	70.0	17.0	35.0
0068100A	10.0	10.0		72.0	25.0	
0068083	10.0	10.0		100.0	40.0	

12 mm Shank

Art. No.	D1 (mm)	D2 (mm)	D3 (mm)	L1 (mm)	L2 (mm)	L3 (mm)
0078812	12.0	12.0	11.7	50.0	10.0	20.0
0078812L	12.0	12.0		60.0	20.0	
0078812B	12.0	12.0		60.0	30.0	

DATRON

Double Flute End Mill with Toric Cut

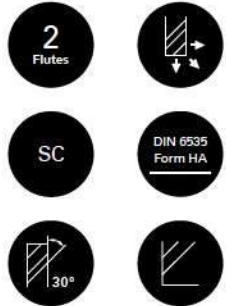

Aluminium



Copper



Brass



Plastic



Bronze



Wood



3 mm Shank

Art. No.	D1 (mm)	D2 (mm)	D3 (mm)	L1 (mm)	L2 (mm)	L3 (mm)
00781005	0.5	3.0	0.45	40.0	0.75	4.0
00781006	0.6	3.0	0.55	40.0	0.9	4.0
00781007	0.7	3.0	0.65	38.0	1.05	4.0
00781008	0.8	3.0	0.75	38.0	1.2	6.0
00781009	0.9	3.0	0.85	38.0	1.3	6.0
00781010	1.0	3.0	0.95	38.0	1.5	6.0
00781011	1.0	3.0	0.95	38.0	1.5	9.0
00781012	1.2	3.0	1.15	38.0	1.8	9.0
00781015	1.5	3.0	1.45	38.0	2.2	9.0
00781020	2.0	3.0	1.95	38.0	3.0	12.0
00781025	2.5	3.0	2.4	40.0	3.5	15.0

6 mm Shank

Art. No.	D1 (mm)	D2 (mm)	D3 (mm)	L1 (mm)	L2 (mm)	L3 (mm)
00781034	4.0	6.0	3.8	50.0	8.0	16.0
00781036	6.0	6.0	5.7	60.0	20.0	33.0

DATRON

Double Flute End Mill Contour Milling

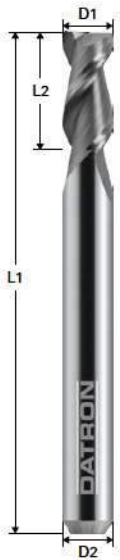

-
-
-
-

Aluminium

Brass

Plastic

Wood

Art. No.	D1 (mm)	D2 (mm)	L1 (mm)	L2 (mm)
0068033	3.0	6.0	57.0	8.0
0068034	4.0	6.0	57.0	11.0
0068035	5.0	6.0	57.0	13.0
0068036	6.0	6.0	57.0	13.0
0068040	8.0	8.0	60.0	20.0
0068041	8.0	8.0	60.0	25.0
0068042	10.0	10.0	70.0	25.0
0068043	12.0	12.0	70.0	25.0

DATRON

Double Flute End Mill HSC+

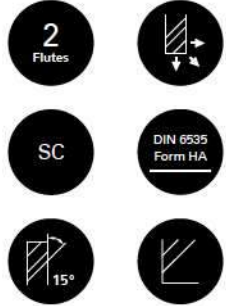

Plastic



Aluminium



Copper



Brass



Wood



3 mm Shank

Art. No.	D1 (mm)	D2 (mm)	L1 (mm)	L2 (mm)
0068815A	1.5	3.0	40.0	6.0
0068820A	2.0	3.0	40.0	6.0
0068830A	3.0	3.0	40.0	10.0

1/8" Shank

Art. No.	D1 (mm)	D2 (mm)	L1 (mm)	L2 (mm)
0068815	1.5	3.175	40.0	6.0
0068820	2.0	3.175	40.0	6.0
0068824	2.4	3.175	40.0	6.0
0068820K	3.0	3.175	40.0	6.0
0068830	3.0	3.175	40.0	10.0

6 mm Shank

Art. No.	D1 (mm)	D2 (mm)	L1 (mm)	L2 (mm)
0068866	1.9	6.0	50.0	6.0
0068862K	2.0	6.0	50.0	4.0
0068862	2.0	6.0	50.0	6.0
0068867	2.4	6.0	50.0	5.0
0068863K	3.0	6.0	50.0	6.0
0068863	3.0	6.0	50.0	10.0
0068864	4.0	6.0	50.0	8.0
0068865	5.0	6.0	50.0	10.0
0068860K	6.0	6.0	50.0	7.0
0068860	6.0	6.0	58.0	12.0

DATRON

Double Flute End Mill HSC Fire

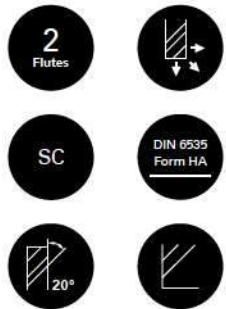

Aluminium



Brass



Plastic



Wood



6 mm Shank

Art. No.	D1 (mm)	D2 (mm)	L1 (mm)	L2 (mm)
0068876S	6.0	6.0	50.0	12.0
0068876K	6.0	6.0	50.0	17.0
0068876	6.0	6.0	60.0	22.0
0068876L	6.0	6.0	70.0	32.0

8 mm Shank

Art. No.	D1 (mm)	D2 (mm)	L1 (mm)	L2 (mm)
0068878S	8.0	8.0	50.0	12.0
0068878K	8.0	8.0	50.0	17.0
0068878	8.0	8.0	60.0	22.0
0068878L	8.0	8.0	70.0	32.0

10 mm Shank

Art. No.	D1 (mm)	D2 (mm)	L1 (mm)	L2 (mm)
0068870S	10.0	10.0	50.0	12.0
0068870K	10.0	10.0	50.0	17.0
0068870	10.0	10.0	60.0	22.0
0068870L	10.0	10.0	70.0	32.0

DATRON

Double Flute End Mill with Internal Cooling

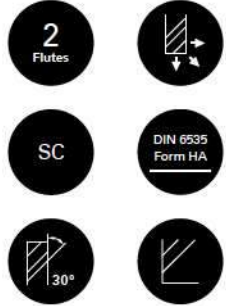

Aluminium



Copper



Brass



Plastic



Wood



Bronze



6 mm Shank

Art. No.	D1 (mm)	D2 (mm)	D3 (mm)	L1 (mm)	L2 (mm)	L3 (mm)
0068906K	6.0	6.0		60.0	14.0	
0068906	6.0	6.0		60.0	22.0	
0068906L	6.0	6.0	5.6	60.0	22.0	32.0

8 mm Shank

Art. No.	D1 (mm)	D2 (mm)	D3 (mm)	L1 (mm)	L2 (mm)	L3 (mm)
0068908K	8.0	8.0		60.0	16.0	
0068908	8.0	8.0		60.0	22.0	
0068908L	8.0	8.0	7.4	60.0	22.0	32.0

10 mm Shank

Art. No.	D1 (mm)	D2 (mm)	D3 (mm)	L1 (mm)	L2 (mm)	L3 (mm)
0068910K	10.0	10.0		70.0	26.0	
0068910	10.0	10.0		70.0	32.0	
0068910L	10.0	10.0	9.2	70.0	32.0	38.0

12 mm Shank

Art. No.	D1 (mm)	D2 (mm)	D3 (mm)	L1 (mm)	L2 (mm)	L3 (mm)
0068912K	12.0	12.0		80.0	26.0	
0068912	12.0	12.0		80.0	32.0	
0068912L	12.0	12.0	11.2	80.0	32.0	48.0

DATRON

Double Flute End Mill for Steel Machining (X.CEED)



Steel



3 mm Shank

Art. No.	D1 (mm)	D2 (mm)	L1 (mm)	L2 (mm)
0078008S	0.9	3.0	38.0	1.1
0078008K	0.9	3.0	38.0	1.8
0078010S	1.0	3.0	38.0	1.2
0078010K	1.0	3.0	38.0	2.0
0078011S	1.1	3.0	38.0	1.2
0078011K	1.1	3.0	38.0	2.2
0078012S	1.2	3.0	38.0	1.2
0078012K	1.2	3.0	38.0	2.4
0078013S	1.3	3.0	38.0	1.2
0078013K	1.3	3.0	38.0	2.6
0078014S	1.4	3.0	38.0	1.4
0078014K	1.4	3.0	38.0	2.8
0078015S	1.5	3.0	38.0	1.4
0078015K	1.5	3.0	38.0	3.0
0078016S	1.6	3.0	38.0	1.4
0078016K	1.6	3.0	38.0	3.2
0078017S	1.7	3.0	38.0	1.4
0078017K	1.7	3.0	38.0	3.4
0078018S	1.8	3.0	38.0	1.5
0078018K	1.8	3.0	38.0	3.6
0078019S	1.9	3.0	38.0	1.5
0078019K	1.9	3.0	38.0	4.0
0078020S	2.0	3.0	38.0	1.8
0078020K	2.0	3.0	38.0	6.0
0078021K	2.1	3.0	38.0	5.0
0078022K	2.2	3.0	38.0	5.0
0078023K	2.3	3.0	38.0	5.0
0078024K	2.4	3.0	38.0	5.0
0078025S	2.5	3.0	38.0	2.0
0078025K	2.5	3.0	38.0	7.0
0078030K	3.0	3.0	38.0	7.0

DATRON

Triple Flute End Mill Roughing Mill for Copper

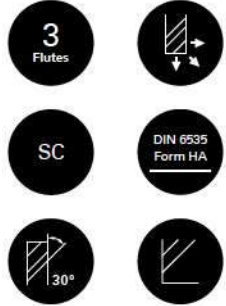
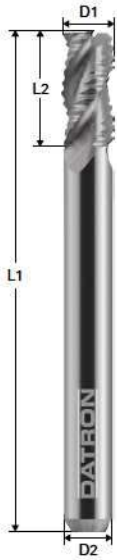

Copper



Art. No.	D1 (mm)	D2 (mm)	L1 (mm)	L2 (mm)
00685903	3.0	6.0	50.0	6.0
00685906	6.0	6.0	50.0	12.0
00685908	8.0	8.0	50.0	16.0
00685910	10.0	10.0	60.0	22.0

DATRON

Triple Flute End Mill Smoothing Mill for Copper

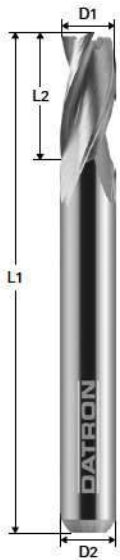

-
-
-
-
-
-



Copper



Art. No.	D1 (mm)	D2 (mm)	L1 (mm)	L2 (mm)
00685610	1.0	6.0	50.0	2.2
00685615	1.5	6.0	50.0	3.2
00685620	2.0	6.0	50.0	4.2
00685630	3.0	6.0	50.0	6.0
00685640	4.0	6.0	50.0	8.0
00685660	6.0	6.0	50.0	11.0
00685680	8.0	8.0	50.0	16.0

DATRON

Triple Flute End Mill with Toric Cut

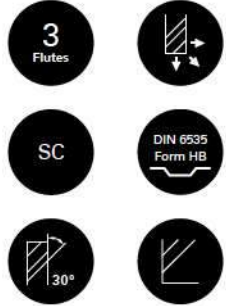
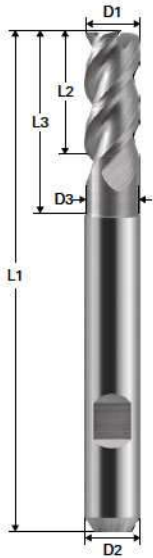

Wood



Aluminium



Brass



Copper



Art. No.	D1 (mm)	D2 (mm)	D3 (mm)	L1 (mm)	L2 (mm)	L3 (mm)
0068033A	3.0	6.0	2.8	58.0	8.0	12.0
0068034A	4.0	6.0	3.8	58.0	11.0	16.0
0068035A	5.0	6.0	4.8	58.0	13.0	19.0
0068036A	6.0	6.0	5.7	58.0	13.0	19.0
0068040A	8.0	8.0	7.8	63.0	19.0	27.0
0068042A	10.0	10.0	9.8	72.0	22.0	32.0
0068043A	12.0	12.0	11.8	83.0	26.0	38.0

DATRON

Triple Flute End Mill with Toric Cut for PU Foam

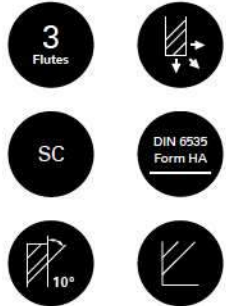
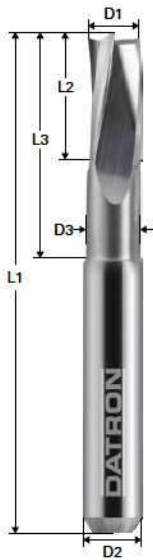

PU Foams



6 mm Shank

Art. No.	D1 (mm)	D2 (mm)	D3 (mm)	L1 (mm)	L2 (mm)	L3 (mm)
00680530	3.0	6.0	2.7	75.0	12.0	41.0
0068053K	3.0	6.0	2.7	50.0	6.0	22.0
00680540	4.0	6.0	3.6	75.0	15.0	41.0
0068054K	4.0	6.0	3.6	50.0	8.0	22.0
00680550	5.0	6.0	4.5	75.0	20.0	41.0
0068055K	5.0	6.0	4.5	50.0	12.0	22.0
00680560	6.0	6.0	5.5	75.0	27.0	42.0
0068056A	6.0	6.0	5.5	100.0	27.0	71.0
0068056K	6.0	6.0	5.5	50.0	12.0	22.0

8 mm Shank

Art. No.	D1 (mm)	D2 (mm)	D3 (mm)	L1 (mm)	L2 (mm)	L3 (mm)
00680580	8.0	8.0	7.5	75.0	28.0	42.0
0068058A	8.0	8.0	7.5	100.0	42.0	71.0
0068058K	8.0	8.0	7.5	50.0	16.0	25.0

10 mm Shank

Art. No.	D1 (mm)	D2 (mm)	D3 (mm)	L1 (mm)	L2 (mm)	L3 (mm)
00680510	10.0	10.0	9.5	115.0	52.0	82.0
0068051K	10.0	10.0	9.5	60.0	20.0	30.0

DATRON

Triple Flute End Mill with Coating (X.CEED)

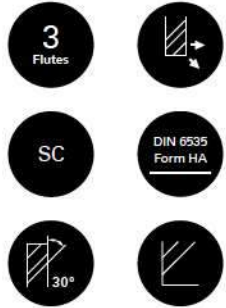

Steel



Art. No.	D1 (mm)	D2 (mm)	L1 (mm)	L2 (mm)
0068551	1.75	3.0	40.0	3.0
0068552	2.0	6.0	50.0	6.0
0068553	3.0	6.0	50.0	6.0
0068554	4.0	6.0	50.0	8.0
0068555	5.0	6.0	50.0	10.0
0068556	6.0	6.0	50.0	10.0

DATRON

Four Flute End Mill with Coating (ALCRONA)

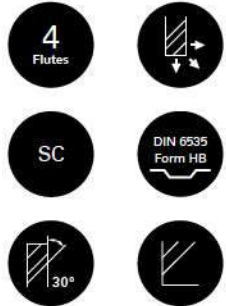
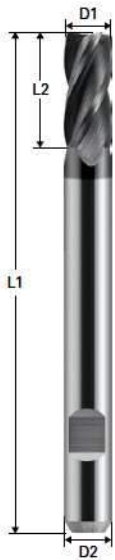

Steel



6 mm Shank

Art. No.	D1 (mm)	D2 (mm)	L1 (mm)	L2 (mm)
0078402	2.0	6.0	50.0	7.0
00784025	2.5	6.0	50.0	8.0
0078403	3.0	6.0	57.0	8.0
0078403A	3.0	6.0	57.0	19.0
00784035	3.5	6.0	57.0	10.0
0078404	4.0	6.0	57.0	11.0
0078404A	4.0	6.0	57.0	19.0
0078404B	4.0	6.0	75.0	25.0
00784045	4.5	6.0	57.0	11.0
0078405	5.0	6.0	57.0	13.0
0078405A	5.0	6.0	75.0	30.0
00784055	5.5	6.0	57.0	13.0
0078406	6.0	6.0	57.0	13.0
0078406A	6.0	6.0	75.0	30.0
0078406B	6.0	6.0	100.0	40.0

8 mm Shank

Art. No.	D1 (mm)	D2 (mm)	L1 (mm)	L2 (mm)
00784065	6.5	8.0	63.0	16.0
0078407	7.0	8.0	63.0	16.0
0078408	8.0	8.0	63.0	19.0
0078408A	8.0	8.0	75.0	30.0

10 mm Shank

Art. No.	D1 (mm)	D2 (mm)	L1 (mm)	L2 (mm)
0078409	9.0	10.0	72.0	19.0
0078410	10.0	10.0	72.0	22.0
0078410A	10.0	10.0	75.0	30.0
0078410B	10.0	10.0	100.0	40.0

12 mm Shank

Art. No.	D1 (mm)	D2 (mm)	L1 (mm)	L2 (mm)
0078412	12.0	12.0	83.0	26.0
0078412A	12.0	12.0	100.0	45.0

DATRON

Micro-Toothed End Mill

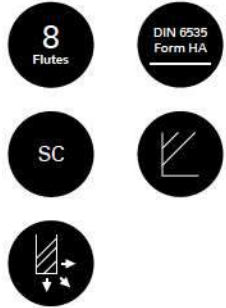

GRP/CRP



3 mm Shank

Art. No.	D1 (mm)	D2 (mm)	L1 (mm)	L2 (mm)
0068106	0.6	3.0	38.0	3.0
0068107	0.7	3.0	38.0	3.5
0068108	0.8	3.0	38.0	5.0
0068110	1.0	3.0	38.0	5.0
0068111	1.1	3.0	38.0	5.0
0068112	1.2	3.0	38.0	5.0
0068115	1.5	3.0	38.0	8.0
0068120	2.0	3.0	38.0	8.0
0068124	2.4	3.0	38.0	8.0
0068130	3.0	3.0	38.0	12.0

1/8" Shank

Art. No.	D1 (mm)	D2 (mm)	L1 (mm)	L2 (mm)
00686506	0.6	3.175	38.0	3.0
00686508	0.8	3.175	38.0	5.0
00686510	1.0	3.175	38.0	5.0
00686511	1.1	3.175	38.0	7.0
00686512	1.2	3.175	38.0	7.0
00686513	1.3	3.175	38.0	7.0
00686514	1.4	3.175	38.0	7.0
00686515	1.5	3.175	38.0	7.0
00686516	1.6	3.175	38.0	8.5
00686517	1.7	3.175	38.0	8.5
00686518	1.8	3.175	38.0	8.5
00686519	1.9	3.175	38.0	8.5
00686520	2.0	3.175	38.0	8.0
00686521	2.1	3.175	38.0	9.0
00686522	2.2	3.175	38.0	9.0
00686523	2.3	3.175	38.0	9.0
00686524	2.4	3.175	38.0	9.0
00686530	3.0	3.175	38.0	10.0

DATRON

Micro-Toothed End Mill with Coating (X.CEED/Diamond)

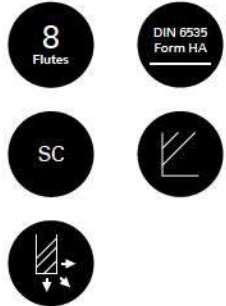
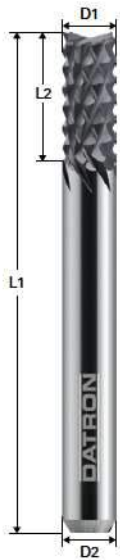

GRP/CRP



3 mm Shank

Art. No.	D1 (mm)	D2 (mm)	L1 (mm)	L2 (mm)	CT
006T106	0.6	3.0	40.0	3.0	X.CEED
006T107	0.7	3.0	40.0	3.5	X.CEED
006T110	1.0	3.0	40.0	5.0	X.CEED
006T115	1.5	3.0	40.0	8.0	X.CEED
006T120	2.0	3.0	40.0	8.0	X.CEED
006T124	2.4	3.0	40.0	8.0	X.CEED
006T130	3.0	3.0	40.0	12.0	X.CEED

6 mm Shank

Art. No.	D1 (mm)	D2 (mm)	L1 (mm)	L2 (mm)	CT
0068164	4.0	6.0	50.0	16.0	X.CEED
0068165	5.0	6.0	50.0	22.0	X.CEED
0068166S	6.0	6.0	50.0	12.0	X.CEED

1/8" Shank

Art. No.	D1 (mm)	D2 (mm)	L1 (mm)	L2 (mm)	CT
0073126B	2.0	3.175	38.0	9.0	Diamond
0073126C	2.4	3.175	38.0	9.0	Diamond
0073126D	3.0	3.175	38.0	9.0	Diamond

DATRON

Diamond Mill for CRP/GRP

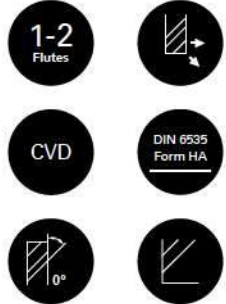
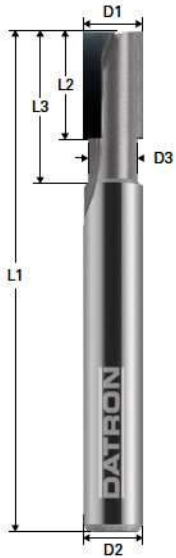

CRP/GRP



Art. No.	D1 (mm)	D2 (mm)	D3 (mm)	L1 (mm)	L2 (mm)	L3 (mm)	Number of Flutes
00781203	3.0	6.0	2.8	50.0	5.0	10.0	1
00781204	4.0	6.0	3.8	50.0	6.0	6.0	2
00781206	6.0	6.0	5.6	50.0	10.0	14.0	2
00781208	8.0	8.0	7.2	50.0	12.0	16.0	2
00781210	10.0	10.0	9.2	60.0	8.0	17.0	2

DATRON

Face Milling Tools

Single Flute End Mill, Stepped	40
Double Flute End Mill, Stepped	41
Double Flute End Mill, Stepped with Edge Radius	42
Double Flute End Mill, Stepped with Edge Radius and Polished Flute for Acrylic Glass	43
Face Milling Tool Monoblock	44

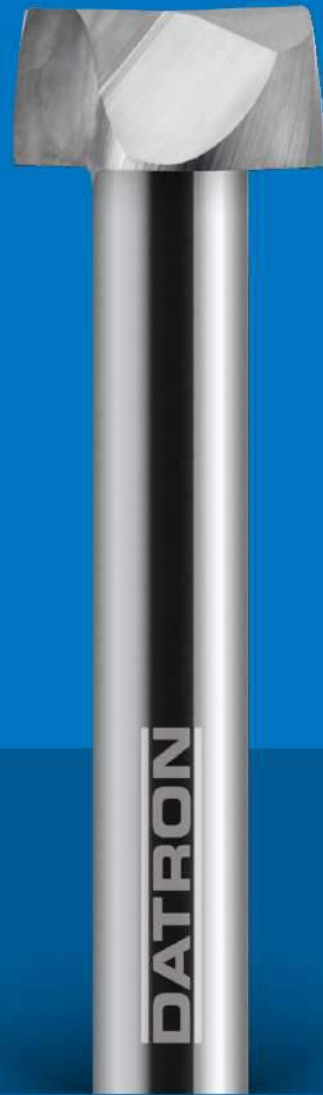

DATRON

Single Flute End Mill Stepped

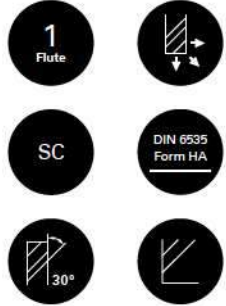

Aluminium



Brass



Copper



Wood



Plastic



Art. No.	D1 (mm)	D2 (mm)	L1 (mm)	L2 (mm)
0068814A	14.0	8.0	45.0	5.0
0068820B	20.0	10.0	50.0	7.0
0068824A	24.0	12.0	60.0	8.5

DATRON

Double Flute End Mill Stepped



- 2 Flutes
- SC
- 30°
- DIN 6535 Form HA

Aluminium

Brass

Copper

Plastic

Wood

6 mm Shank

Art. No.	D1 (mm)	D2 (mm)	L1 (mm)	L2 (mm)
0068441	8.0	6.0	50.0	10.0
0068440	10.0	6.0	50.0	10.0
0068442G	12.0	6.0	50.0	6.0
0068442A	14.0	6.0	50.0	6.0

8 mm Shank

Art. No.	D1 (mm)	D2 (mm)	L1 (mm)	L2 (mm)
0068443G	14.0	8.0	50.0	6.0
0068444G	20.0	8.0	50.0	8.0

10 mm Shank

Art. No.	D1 (mm)	D2 (mm)	L1 (mm)	L2 (mm)
0078812A	12.0	10.0	50.0	10.0
0078814A	14.0	10.0	50.0	10.0
0078816A	16.0	10.0	50.0	10.0
0078816B	16.0	10.0	82.0	12.0
0078818A	18.0	10.0	50.0	10.0
0078820A	20.0	10.0	50.0	10.0

12 mm Shank

Art. No.	D1 (mm)	D2 (mm)	L1 (mm)	L2 (mm)
0078814	14.0	12.0	50.0	10.0
0078816	16.0	12.0	50.0	10.0
0078818	18.0	12.0	50.0	10.0
0078820	20.0	12.0	50.0	10.0

DATRON

Double Flute End Mill Stepped with Edge Radius

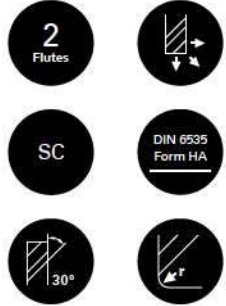

Aluminium



Brass



Copper



Wood



Plastic



Art. No.	D1 (mm)	D2 (mm)	L1 (mm)	L2 (mm)	R (mm)
0068442	12.0	6.0	50.0	6.0	0.5
0068443	14.0	8.0	50.0	6.0	0.5
0068444	20.0	8.0	50.0	8.0	0.5

DATRON

Double Flute End Mill

Stepped with Edge Radius and Polished Flute for Acrylic Glass

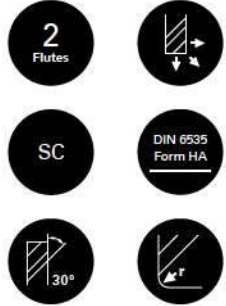

Acrylic Glass



Plastic



6 mm Shank

Art. No.	D1 (mm)	D2 (mm)	L1 (mm)	L2 (mm)	R (mm)
0078440	10.0	6.0	50.0	6.0	1.0
0078442	12.0	6.0	50.0	6.0	1.0

8 mm Shank

Art. No.	D1 (mm)	D2 (mm)	L1 (mm)	L2 (mm)	R (mm)
0078444	14.0	8.0	50.0	6.0	1.0
0078446	16.0	8.0	50.0	6.0	1.0

DATRON

Face Milling Tool Monoblock

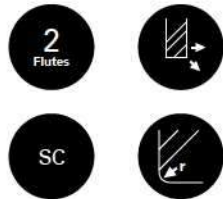

Aluminium

Brass

Plastic

Bronze



Copper

Steel

Wood



Art. No.	Type	D1 (mm)	D3 (mm)	L1 (mm)	L2 (mm)
0078920*	HSK-E-25	20.0	18.5	40.0	10.0
0078920L*	HSK-E-25	20.0	18.5	60.0	10.0
0078924*	HSK-E-32	24.0	22.5	45.0	10.0
0078924L*	HSK-E-32	24.0	22.5	65.0	10.0

Art. No.	Article Description	For Face Milling Tool	Material
0078920A	Cutting Insert (polished)	0078920 / 20L / 24 / 24L	Aluminium
0078920B	Cutting Insert	0078920 / 20L / 24 / 24L	Steel

Art. No.	Article Description
0078920C	Screw Set with 10 Screws and Screwdriver

Please note: This tool can only be measured with the DATRON tool length sensor.

*Please specify which cutting insert is needed when ordering!

DATRON

Ball Nose End Mills

Ball Nose End Mill, One Flute	46
Ball Nose End Mill, One Flute and Polished for Acrylic Glass	47
Ball Nose End Mill, Two Flutes	48
Ball Nose End Mill, Two Flutes with Toric Cut	49
Ball Nose End Mill, Two Flutes with Coating (ALCRONA)	50
Ball Nose End Mill, Four Flutes with Coating (ALCRONA)	51



DATRON

Ball Nose End Mill One Flute

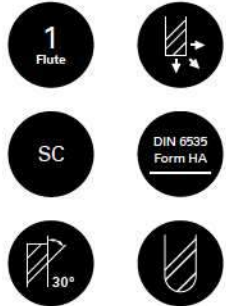
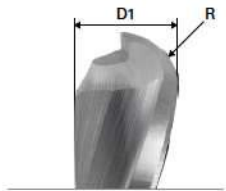

Aluminium



Plastic



Wood



Bronze



Brass



Art. No.	D1 (mm)	D2 (mm)	L1 (mm)	L2 (mm)	R (mm)
0068171E	1.0	3.0	40.0	4.0	0.5
0068172E	2.0	6.0	50.0	7.0	1.0
0068173E	3.0	6.0	50.0	8.0	1.5
0068174E	4.0	6.0	50.0	10.0	2.0
0068175E	5.0	6.0	50.0	12.0	2.5
0068176E	6.0	6.0	50.0	14.0	3.0
0068178E	8.0	8.0	60.0	14.0	4.0
0068179E	10.0	10.0	60.0	20.0	5.0

DATRON

Ball Nose End Mill One Flute and Polished for Acrylic Glass

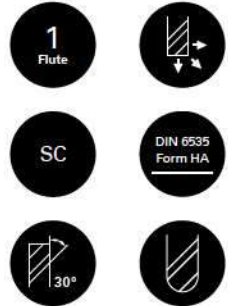
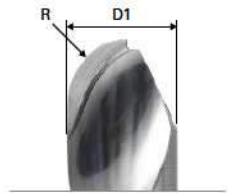

Acrylic Glass



Plastic



6 mm Shank

Art. No.	D1 (mm)	D2 (mm)	D3 (mm)	L1 (mm)	L2 (mm)	L3 (mm)	R (mm)
0068191E	1.0	6.0	0.9	50.0	4.0	12.0	0.5
0068191S	1.5	6.0	1.4	50.0	5.0	12.0	0.75
0068192E	2.0	6.0	1.8	50.0	6.0	20.0	1.0
0068192S	2.5	6.0	2.3	50.0	7.0	20.0	1.25
0068193E	3.0	6.0	2.8	50.0	8.0	21.0	1.5
0068194E	4.0	6.0	3.8	50.0	10.0	21.0	2.0
0068195E	5.0	6.0	4.8	50.0	12.0	22.0	2.5
0068196E	6.0	6.0	5.8	50.0	14.0	22.0	3.0

DATRON

Ball Nose End Mill Two Flutes

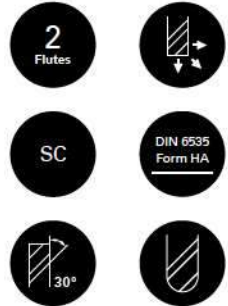
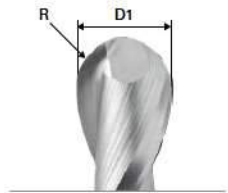

Art. No.	D1 (mm)	D2 (mm)	L1 (mm)	L2 (mm)	R (mm)
00684003	0.3	3.0	40.0	0.5	0.15
00684005	0.5	3.0	39.0	0.8	0.25
00684007	0.7	3.0	39.0	2.1	0.35
0068400	1.0	3.0	38.0	3.0	0.5
0068403	3.0	6.0	50.0	4.0	1.5
0068404	4.0	6.0	50.0	5.0	2.0
0068405	5.0	6.0	50.0	5.0	2.5
0068406	6.0	6.0	50.0	10.0	3.0
0068408	8.0	8.0	50.0	12.0	4.0

DATRON

Ball Nose End Mill Two Flutes with Toric Cut

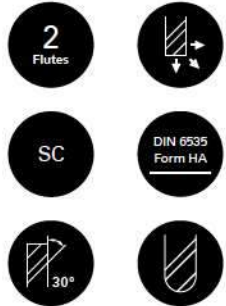
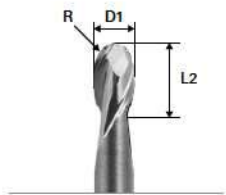
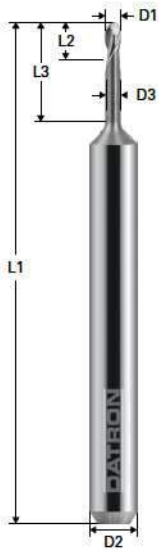

Art. No.	D1 (mm)	D2 (mm)	D _s (mm)	L1 (mm)	L2 (mm)	L3 (mm)	R (mm)
00782004	0.4	3.0	0.35	39.0	0.6	2.0	0.2
00782005	0.5	3.0	0.45	39.0	0.75	4.0	0.25
00782006	0.6	3.0	0.55	39.0	0.9	4.0	0.3
00782008	0.8	3.0	0.75	39.0	1.2	6.0	0.4
00782010	1.0	3.0	0.95	39.0	1.5	6.0	0.5
00782011	1.0	3.0	0.95	39.0	1.5	9.0	0.5
00782012	1.2	3.0	1.15	39.0	1.8	9.0	0.6
00782015	1.5	3.0	1.45	39.0	2.2	9.0	0.75
00782020	2.0	3.0	1.95	39.0	3.0	12.0	1.0
0078502	2.0	6.0	1.8	75.0	5.0	20.0	1.0
0078503	3.0	6.0	2.8	75.0	6.0	20.0	1.5
0078504	4.0	6.0	3.8	75.0	8.0	20.0	2.0
0078505	5.0	6.0	4.8	100.0	20.0	40.0	2.5
0078506	6.0	6.0	5.8	100.0	20.0	40.0	3.0
0078508	8.0	8.0	7.8	100.0	20.0	40.0	4.0
0078510	10.0	10.0	9.8	100.0	20.0	40.0	5.0
0078512	12.0	12.0	11.7	100.0	20.0	40.0	6.0

DATRON

Ball Nose End Mill Two Flutes with Coating (ALCRONA)

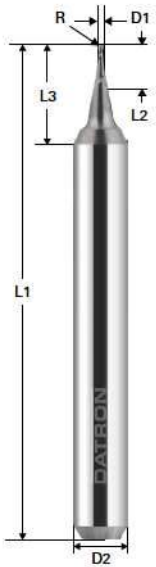

Steel



3 mm Shank

Art. No.	D1 (mm)	D2 (mm)	L1 (mm)	L2 (mm)	R (mm)
00684004	0.4	3.0	39.0	1.2	0.2
00684010	0.5	3.0	39.0	1.5	0.25
00684006	0.6	3.0	39.0	1.8	0.3
00684008	0.8	3.0	38.0	2.4	0.4
00684015	1.5	3.0	38.0	3.0	0.75
0068402	2.0	3.0	38.0	4.0	1.0
00684025	2.5	3.0	38.0	5.0	1.25
0068401	3.0	3.0	38.0	6.0	1.5

DATRON

Ball Nose End Mill Four Flutes with Coating (ALCRONA)



Steel



6 mm Shank					
Art. No.	D1 (mm)	D2 (mm)	L1 (mm)	L2 (mm)	R (mm)
0078542	2.0	6.0	57.0	6.0	1.0
0078543	3.0	6.0	57.0	8.0	1.5
0078543A	3.0	6.0	57.0	20.0	1.5
0078544	4.0	6.0	57.0	11.0	2.0
0078544A	4.0	6.0	57.0	20.0	2.0
0078545	5.0	6.0	57.0	13.0	2.5
0078545A	5.0	6.0	75.0	30.0	2.5
0078546	6.0	6.0	57.0	13.0	3.0
0078546A	6.0	6.0	75.0	30.0	3.0

8 mm Shank					
Art. No.	D1 (mm)	D2 (mm)	L1 (mm)	L2 (mm)	R (mm)
0078548	8.0	8.0	63.0	19.0	4.0
0078548A	8.0	8.0	75.0	30.0	4.0

10 mm Shank					
Art. No.	D1 (mm)	D2 (mm)	L1 (mm)	L2 (mm)	R (mm)
0078550	10.0	10.0	72.0	22.0	5.0
0078550A	10.0	10.0	75.0	30.0	5.0

12 mm Shank					
Art. No.	D1 (mm)	D2 (mm)	L1 (mm)	L2 (mm)	R (mm)
0078552	12.0	12.0	83.0	26.0	6.0
0078552A	12.0	12.0	100.0	45.0	6.0

DATRON

Toric End Mills

Double Flute End Mill with Edge Radius	54
Double Flute End Mill with Edge Radius and Coating (Triple-Cut)	55
Four Flute End Mill with Edge Radius and Coating (X.CEED)	56
Four Flute End Mill with Double Radius and Coating (X.CEED)	57



DATRON

Double Flute End Mill with Edge Radius

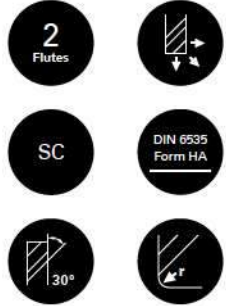
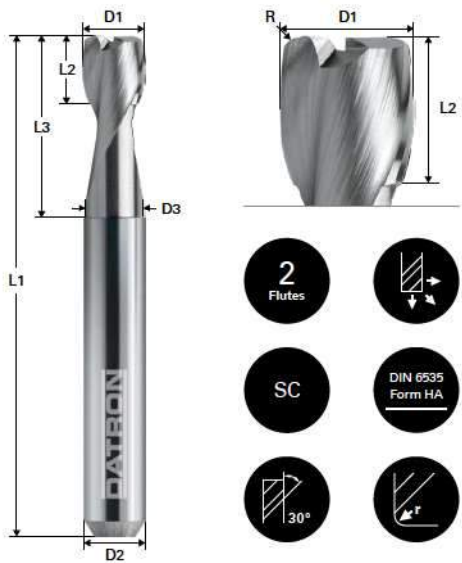

Aluminium



Brass



Copper



Plastic



Wood



6 mm Shank

Art. No.	D1 (mm)	D2 (mm)	D3 (mm)	L1 (mm)	L2 (mm)	L3 (mm)	R (mm)
0068460S	6.0	6.0		50.0	6.0		0.5
0068460F	6.0	6.0	5.8	58.0	7.0	21.0	1.0

8 mm Shank

Art. No.	D1 (mm)	D2 (mm)	D3 (mm)	L1 (mm)	L2 (mm)	L3 (mm)	R (mm)
0068080K	8.0	8.0		50.0	12.0		1.0
0078808R	8.0	8.0	7.7	60.0	10.0	22.0	0.2
0068080	8.0	8.0	7.8	60.0	9.0	23.0	1.0

DATRON

Double Flute End Mill with Edge Radius and Coating (Triple-Cut)



3 mm Shank

Art. No.	D1 (mm)	D2 (mm)	D3 (mm)	L1 (mm)	L2 (mm)	L3 (mm)	R (mm)
00781043	3.0	3.0	2.7	50.0	4.0	14.0	0.3
00781063	3.0	3.0	2.7	50.0	4.0	14.0	1.0

4 mm Shank

Art. No.	D1 (mm)	D2 (mm)	D3 (mm)	L1 (mm)	L2 (mm)	L3 (mm)	R (mm)
00781044	4.0	4.0	3.7	50.0	5.0	16.0	0.4
00781064	4.0	4.0	3.7	50.0	5.0	16.0	1.0

5 mm Shank

Art. No.	D1 (mm)	D2 (mm)	D3 (mm)	L1 (mm)	L2 (mm)	L3 (mm)	R (mm)
00781045	5.0	5.0	4.6	54.0	6.0	18.0	0.5
00781065	5.0	5.0	4.6	54.0	6.0	18.0	1.0

6 mm Shank

Art. No.	D1 (mm)	D2 (mm)	D3 (mm)	L1 (mm)	L2 (mm)	L3 (mm)	R (mm)
00781046	6.0	6.0	5.5	58.0	7.0	21.0	0.5
00781066	6.0	6.0	5.5	58.0	7.0	21.0	1.0

8 mm Shank

Art. No.	D1 (mm)	D2 (mm)	D3 (mm)	L1 (mm)	L2 (mm)	L3 (mm)	R (mm)
00781048	8.0	8.0	7.4	63.0	9.0	27.0	0.5
00781068	8.0	8.0	7.4	63.0	9.0	27.0	1.0

10 mm Shank

Art. No.	D1 (mm)	D2 (mm)	D3 (mm)	L1 (mm)	L2 (mm)	L3 (mm)	R (mm)
00781050	10.0	10.0	9.2	72.0	11.0	32.0	0.5
00781070	10.0	10.0	9.2	72.0	11.0	32.0	1.0

DATRON

Four Flute End Mill with Edge Radius and Coating (X.CEED)

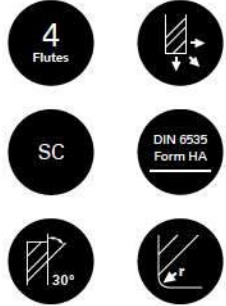

Steel



6 mm Shank

Art. No.	D1 (mm)	D2 (mm)	D3 (mm)	L1 (mm)	L2 (mm)	L3 (mm)	R (mm)
0078620	2.0	6.0	1.8	50.0	4.0	12.0	0.2
0078620A	2.0	6.0	1.8	50.0	4.0	16.0	0.2
0078623	3.0	6.0	2.7	50.0	4.0	14.0	0.3
0078623A	3.0	6.0	2.7	50.0	4.0	18.0	0.3
0078624	4.0	6.0	3.7	50.0	5.0	16.0	0.4
0078625	5.0	6.0	4.6	54.0	6.0	18.0	0.5
0078625A	5.0	6.0	4.6	54.0	6.0	18.0	1.0
0078626	6.0	6.0	5.5	57.0	7.0	21.0	0.5
0078626A	6.0	6.0	5.5	57.0	7.0	21.0	1.0

8 mm Shank

Art. No.	D1 (mm)	D2 (mm)	D3 (mm)	L1 (mm)	L2 (mm)	L3 (mm)	R (mm)
0078628	8.0	8.0	7.4	63.0	9.0	27.0	0.5
0078628A	8.0	8.0	7.4	63.0	9.0	27.0	1.0

10 mm Shank

Art. No.	D1 (mm)	D2 (mm)	D3 (mm)	L1 (mm)	L2 (mm)	L3 (mm)	R (mm)
0078630	10.0	10.0	9.2	72.0	11.0	32.0	0.5
0078630A	10.0	10.0	9.2	72.0	11.0	32.0	1.0

DATRON

Four Flute End Mill with Double Radius and Coating (X.CEED)

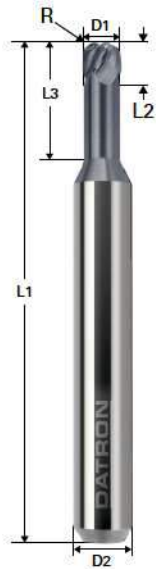

-
-
-
-
-
-



Steel



6 mm Shank

Art. No.	D1 (mm)	D2 (mm)	L1 (mm)	L2 (mm)	R (mm)
00686903	3.0	6.0	50.0	1.0	0.8
00686904	4.0	6.0	50.0	1.0	0.8
00686906	6.0	6.0	50.0	1.0	0.8

DATRON

Countersink Tools

Countersink Tool	60
Countersink Tool for Acrylic Glass	61
Countersink Tool for PU Foam	62
Milling Countersink Tool	63
V-Slotting Mill	64



DATRON

Countersink Tool

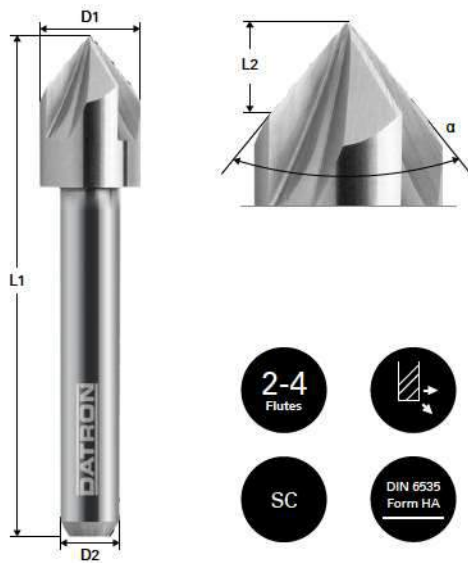

Aluminium



Plastic



Wood



Bronze



Brass



Art. No.	D1 (mm)	D2 (mm)	L1 (mm)	L2 (mm)	α (°)	Number of Flutes
0068478A	3.0	3.0	40.0	2.5	60	2
0068478	3.0	3.0	40.0	1.5	90	2
0068479B	6.0	6.0	50.0	8.2	40	3
0068480B	6.0	6.0	50.0	5.1	60	4
0068479C	6.0	6.0	50.0	4.2	70	3
0068479	6.0	6.0	50.0	3.0	90	3
0068479A	6.0	6.0	50.0	1.7	120	4
0068479D	6.0	6.0	50.0	1.1	140	3
0068480	8.0	6.0	50.0	4.0	90	3
0068480C	8.0	6.0	50.0	3.3	100	4
0068480A	8.0	6.0	50.0	2.3	120	3
0068483	10.0	6.0	50.0	5.0	90	3
0068483A	10.0	6.0	50.0	2.8	120	4
0068483E	12.0	6.0	50.0	3.4	120	4
0068483D	12.0	8.0	50.0	6.0	90	4
0068483H	14.0	8.0	50.0	7.0	90	4
0068483B	10.0	10.0	50.0	5.0	90	3

DATRON

Countersink Tool for Acrylic Glass

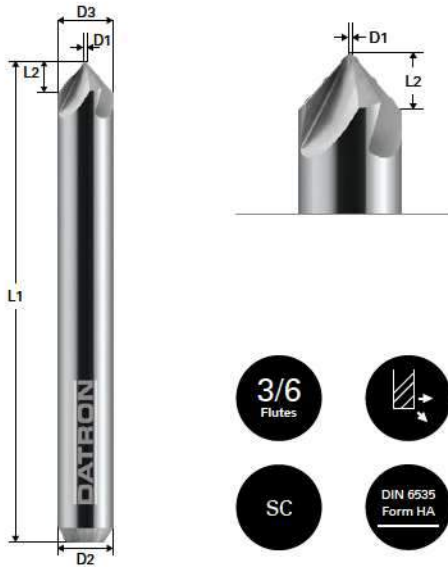

Acrylic Glass



Plastic



6 mm Shank							
Art. No.	D1 (mm)	D2 (mm)	D3 (mm)	L1 (mm)	L2 (mm)	α (°)	Number of Flutes
00685806	0.1	6.0	6.0	50.0	3.0	90	6
00685808	0.1	6.0	8.0	50.0	4.0	90	6
00685810	4.0	6.0	10.0	50.0	3.0	90	3
00685812	4.0	6.0	12.0	50.0	4.0	90	3
00685814	4.0	6.0	14.0	50.0	5.0	90	3
00685816	4.0	6.0	16.0	50.0	6.0	90	3

DATRON

Countersink Tool for PU Foam

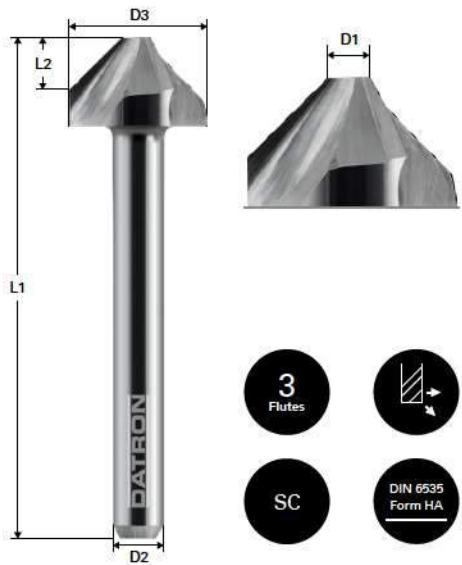

PU Foams



6 mm Shank							
Art. No.	D1 (mm)	D2 (mm)	D3 (mm)	L1 (mm)	L2 (mm)	α (°)	
0068485C	4.0	6.0	10.0	50.0	3.0	90	
0068485D	4.0	6.0	12.0	50.0	4.0	90	
0068485E	4.0	6.0	14.0	50.0	5.0	90	
0068485F	4.0	6.0	16.0	50.0	6.0	90	

DATRON

Milling Countersink Tool



Aluminium



Plastic



Wood



Bronze



Brass



6 mm Shank

Art. No.	D1 (mm)	D2 (mm)	L1 (mm)	L2 (mm)	α (°)
0068772D	2.0	6.0	50.0	1.0	90
0068772E	2.0	6.0	50.0	1.5	90
0068772	2.0	6.0	50.0	1.9	90
0068772F	2.0	6.0	50.0	2.5	90
0068772A	2.0	6.0	50.0	2.9	90
0068772G	2.0	6.0	50.0	4.0	90
0068772B	2.0	6.0	50.0	4.9	90
0068773D	3.0	6.0	50.0	1.0	90
0068773E	3.0	6.0	50.0	1.5	90
0068773G	3.0	6.0	50.0	2.0	90
0068773F	3.0	6.0	50.0	2.5	90
0068773	3.0	6.0	50.0	2.9	90
0068773A	3.0	6.0	50.0	3.9	90
0068773B	3.0	6.0	50.0	4.9	90
0068774D	4.0	6.0	50.0	1.0	90
0068774E	4.0	6.0	50.0	1.5	90
0068774G	4.0	6.0	50.0	2.0	90
0068774F	4.0	6.0	50.0	2.5	90
0068774	4.0	6.0	50.0	2.9	90
0068774A	4.0	6.0	50.0	3.9	90
0068774B	4.0	6.0	50.0	5.0	90
0068775D	5.0	6.0	50.0	1.0	90
0068775E	5.0	6.0	50.0	1.5	90
0068775G	5.0	6.0	50.0	2.0	90
0068775F	5.0	6.0	50.0	2.5	90
0068775	5.0	6.0	50.0	3.0	90
0068775A	5.0	6.0	50.0	4.0	90
0068775B	5.0	6.0	50.0	5.0	90

DATRON

V-Slotting Mill

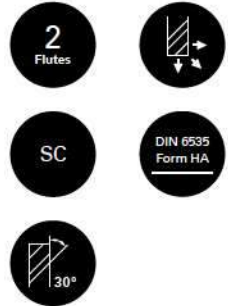
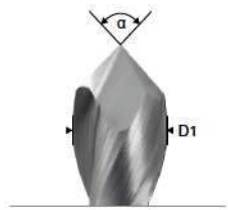

Aluminium



Plastic



Wood



Bronze



Brass



6 mm Shank

Art. No.	D1 (mm)	D2 (mm)	L1 (mm)	L2 (mm)	α (°)
0068795A	5.0	6.0	50.0	10.0	60
0068795	5.0	6.0	50.0	10.0	90
0068795B	5.0	6.0	50.0	10.0	120

8 mm Shank

Art. No.	D1 (mm)	D2 (mm)	L1 (mm)	L2 (mm)	α (°)
0068796A	6.0	8.0	58.0	12.0	60
0068796	6.0	8.0	58.0	12.0	90
0068796B	6.0	8.0	58.0	12.0	120

10 mm Shank

Art. No.	D1 (mm)	D2 (mm)	L1 (mm)	L2 (mm)	α (°)
0068798A	8.0	10.0	70.0	16.0	60
0068798	8.0	10.0	70.0	16.0	90
0068798B	8.0	10.0	70.0	16.0	120

DATRON
Drills

Drill, 3 mm Shank	66
Drill, 1/8" Shank	68
Drill, 6 mm Shank	70



DATRON

Drill 3 mm Shank



Aluminium



Copper



Bronze



Brass



Plastic



Steel



Wood



3 mm Shank

Art. No.	D1 (mm)	D2 (mm)	L1 (mm)	L2 (mm)
00682015	0.15	3.0	38.0	2.0
0068202	0.2	3.0	38.0	3.5
00682025	0.25	3.0	38.0	3.5
0068203	0.3	3.0	38.0	3.5
00682035	0.35	3.0	38.0	3.5
0068204	0.4	3.0	38.0	6.0
00682045	0.45	3.0	38.0	6.0
0068205	0.5	3.0	38.0	6.0
00682055	0.55	3.0	38.0	6.0
0068206	0.6	3.0	38.0	6.5
00682065	0.65	3.0	38.0	6.5
0068207	0.7	3.0	38.0	10.5
00682075	0.75	3.0	38.0	10.5
0068208	0.8	3.0	38.0	10.5
00682085	0.85	3.0	38.0	10.5
0068209	0.9	3.0	38.0	10.5
00682095	0.95	3.0	38.0	10.5
0068210	1.0	3.0	38.0	10.5
00682105	1.05	3.0	38.0	10.5
0068211	1.1	3.0	38.0	10.5
00682115	1.15	3.0	38.0	10.5
0068212	1.2	3.0	38.0	10.5
00682125	1.25	3.0	38.0	10.5
0068213	1.3	3.0	38.0	10.5
00682135	1.35	3.0	38.0	10.5
0068214	1.4	3.0	38.0	10.5
00682145	1.45	3.0	38.0	10.5
0068215	1.5	3.0	38.0	10.5
00682155	1.55	3.0	38.0	10.5
0068216	1.6	3.0	38.0	10.5
00682165	1.65	3.0	38.0	10.5
0068217	1.7	3.0	38.0	10.5
00682175	1.75	3.0	38.0	10.5
0068218	1.8	3.0	38.0	10.5
00682185	1.85	3.0	38.0	10.5

Art. No.	D1 (mm)	D2 (mm)	L1 (mm)	L2 (mm)
0068219	1.9	3.0	38.0	10.5
00682195	1.95	3.0	38.0	10.5
0068220	2.0	3.0	38.0	10.5
00682205	2.05	3.0	38.0	10.5
0068221	2.1	3.0	38.0	10.5
00682215	2.15	3.0	38.0	10.5
0068222	2.2	3.0	38.0	10.5
00682225	2.25	3.0	38.0	10.5
0068223	2.3	3.0	38.0	10.5
00682235	2.35	3.0	38.0	10.5
0068224	2.4	3.0	38.0	10.5
00682245	2.45	3.0	38.0	10.5
0068225	2.5	3.0	38.0	10.5
00682255	2.55	3.0	38.0	10.5
0068226	2.6	3.0	38.0	10.5
00682265	2.65	3.0	38.0	10.5
0068227	2.7	3.0	38.0	10.5
00682275	2.75	3.0	38.0	10.5
0068228	2.8	3.0	38.0	10.5
00682285	2.85	3.0	38.0	10.5
0068229	2.9	3.0	38.0	10.5
00682295	2.95	3.0	38.0	10.5
0068230	3.0	3.0	38.0	10.5
0068231	3.1	3.0	38.0	12.0
0068232	3.2	3.0	38.0	12.0
0068233	3.3	3.0	38.0	12.0
0068234	3.4	3.0	38.0	12.0
0068235	3.5	3.0	38.0	12.0
0068236	3.6	3.0	38.0	12.0
0068237	3.7	3.0	38.0	12.0
0068238	3.8	3.0	38.0	12.0
0068239	3.9	3.0	38.0	12.0
0068240	4.0	3.0	38.0	12.0
0068241	4.1	3.0	38.0	12.0
0068242	4.2	3.0	38.0	12.0
0068243	4.3	3.0	38.0	12.0
0068244	4.4	3.0	38.0	12.0
0068245	4.5	3.0	38.0	12.0
0068246	4.6	3.0	38.0	12.0
0068247	4.7	3.0	38.0	12.0
0068248	4.8	3.0	38.0	12.0
0068249	4.9	3.0	38.0	12.0
0068250	5.0	3.0	38.0	12.0
0068251	5.1	3.0	38.0	12.0
0068252	5.2	3.0	38.0	12.0
0068253	5.3	3.0	38.0	12.0
0068254	5.4	3.0	38.0	12.0
0068255	5.5	3.0	38.0	12.0
0068256	5.6	3.0	38.0	12.0
0068257	5.7	3.0	38.0	12.0
0068258	5.8	3.0	38.0	12.0
0068259	5.9	3.0	38.0	12.0
0068260	6.0	3.0	38.0	12.0
0068261	6.1	3.0	38.0	12.0
0068262	6.2	3.0	38.0	12.0
0068263	6.3	3.0	38.0	12.0
0068264	6.4	3.0	38.0	12.0
0068265	6.5	3.0	38.0	12.0

DATRON

Drill 1/8" Shank



- 2 Flutes
- SC (Shank HSS)
- DIN 6535 Form HA
- 30°
- 130°
≥ 3.0 mm
- 165°
≥ 3.0 mm

Aluminium

Copper

Bronze

Brass

Plastic

Steel

Wood

1/8" Shank				
Art. No.	D1 (mm)	D2 (mm)	L1 (mm)	L2 (mm)
0068701	0.1	3.175	38.0	1.0
00687015	0.15	3.175	38.0	2.5
0068702	0.2	3.175	38.0	3.2
00687025	0.25	3.175	38.0	3.5
0068703	0.3	3.175	38.0	5.5
00687035	0.35	3.175	38.0	5.5
0068704	0.4	3.175	38.0	5.5
00687045	0.45	3.175	38.0	5.5
0068705	0.5	3.175	38.0	5.5
00687055	0.55	3.175	38.0	5.5
0068706	0.6	3.175	38.0	7.0
00687065	0.65	3.175	38.0	8.5
0068707	0.7	3.175	38.0	10.5
00687075	0.75	3.175	38.0	10.5
0068708	0.8	3.175	38.0	10.5
00687085	0.85	3.175	38.0	10.5
0068709	0.9	3.175	38.0	10.5
00687095	0.95	3.175	38.0	10.5
0068710	1.0	3.175	38.0	10.5
00687105	1.05	3.175	38.0	10.5
0068711	1.1	3.175	38.0	10.5
00687115	1.15	3.175	38.0	10.5
0068712	1.2	3.175	38.0	10.5
00687125	1.25	3.175	38.0	10.5
0068713	1.3	3.175	38.0	10.5
00687135	1.35	3.175	38.0	10.5
0068714	1.4	3.175	38.0	10.5
00687145	1.45	3.175	38.0	10.5
0068715	1.5	3.175	38.0	10.5
00687155	1.55	3.175	38.0	10.5
0068716	1.6	3.175	38.0	10.5
00687165	1.65	3.175	38.0	10.5
0068717	1.7	3.175	38.0	10.5
00687175	1.75	3.175	38.0	10.5
0068718	1.8	3.175	38.0	10.5

Art. No.	D1 (mm)	D2 (mm)	L1 (mm)	L2 (mm)
00687185	1.85	3.175	38.0	10.5
0068719	1.9	3.175	38.0	10.5
00687195	1.95	3.175	38.0	10.5
0068720	2.0	3.175	38.0	10.5
00687205	2.05	3.175	38.0	10.5
0068721	2.1	3.175	38.0	10.5
00687215	2.15	3.175	38.0	10.5
0068722	2.2	3.175	38.0	10.5
00687225	2.25	3.175	38.0	10.5
0068723	2.3	3.175	38.0	10.5
00687235	2.35	3.175	38.0	10.5
0068724	2.4	3.175	38.0	10.5
00687245	2.45	3.175	38.0	10.5
0068725	2.5	3.175	38.0	10.5
00687255	2.55	3.175	38.0	10.5
0068726	2.6	3.175	38.0	10.5
00687265	2.65	3.175	38.0	10.5
0068727	2.7	3.175	38.0	10.5
00687275	2.75	3.175	38.0	10.5
0068728	2.8	3.175	38.0	10.5
00687285	2.85	3.175	38.0	10.5
0068729	2.9	3.175	38.0	10.5
00687295	2.95	3.175	38.0	10.5
0068730	3.0	3.175	38.0	10.5
00687305	3.05	3.175	38.0	10.5
0068731	3.1	3.175	38.0	10.5
0068732	3.2	3.175	38.0	12.0
0068733	3.3	3.175	38.0	12.0
0068734	3.4	3.175	38.0	12.0
0068735	3.5	3.175	38.0	12.0
0068736	3.6	3.175	38.0	12.0
0068737	3.7	3.175	38.0	12.0
0068738	3.8	3.175	38.0	12.0
0068739	3.9	3.175	38.0	12.0
0068740	4.0	3.175	38.0	12.0
0068741	4.1	3.175	38.0	12.0
0068742	4.2	3.175	38.0	12.0
0068743	4.3	3.175	38.0	12.0
0068744	4.4	3.175	38.0	12.0
0068745	4.5	3.175	38.0	12.0
0068746	4.6	3.175	38.0	12.0
0068747	4.7	3.175	38.0	12.0
0068748	4.8	3.175	38.0	12.0
0068749	4.9	3.175	38.0	12.0
0068750	5.0	3.175	38.0	12.0
0068751	5.1	3.175	38.0	12.0
0068752	5.2	3.175	38.0	12.0
0068753	5.3	3.175	38.0	12.0
0068754	5.4	3.175	38.0	12.0
0068755	5.5	3.175	38.0	12.0
0068756	5.6	3.175	38.0	12.0
0068757	5.7	3.175	38.0	12.0
0068758	5.8	3.175	38.0	12.0
0068759	5.9	3.175	38.0	12.0
0068760	6.0	3.175	38.0	12.0
0068761	6.1	3.175	38.0	12.0
0068762	6.2	3.175	38.0	12.0
0068763	6.3	3.175	38.0	12.0
0068764	6.4	3.175	38.0	12.0
0068765	6.5	3.175	38.0	12.0

DATRON

Drill 6 mm Shank

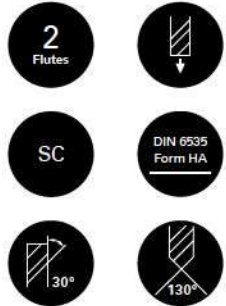

Aluminium



Copper



Bronze



Brass



Plastic



Wood



6 mm Shank

Art. No.	D1 (mm)	D2 (mm)	L1 (mm)	L2 (mm)
0068230L	3.0	6.0	50.0	21.0
0068231L	3.1	6.0	50.0	21.0
0068232L	3.2	6.0	50.0	21.0
0068233L	3.3	6.0	50.0	21.0
0068234L	3.4	6.0	50.0	21.0
0068235L	3.5	6.0	50.0	21.0
0068236L	3.6	6.0	50.0	21.0
0068237L	3.7	6.0	50.0	21.0
0068238L	3.8	6.0	50.0	21.0
0068239L	3.9	6.0	50.0	21.0
0068240L	4.0	6.0	50.0	21.0
0068240X	4.0	6.0	60.0	31.0
0068241L	4.1	6.0	50.0	21.0
0068242L	4.2	6.0	50.0	21.0
0068243L	4.3	6.0	50.0	21.0
0068244L	4.4	6.0	50.0	21.0
0068245L	4.5	6.0	50.0	21.0
0068245X	4.5	6.0	60.0	31.0
0068246L	4.6	6.0	50.0	21.0
0068247L	4.7	6.0	50.0	21.0
0068248L	4.8	6.0	50.0	21.0
0068249L	4.9	6.0	50.0	21.0
0068250L	5.0	6.0	50.0	21.0
0068250X	5.0	6.0	60.0	31.0
0068251L	5.1	6.0	50.0	21.0
0068252L	5.2	6.0	50.0	21.0
0068253L	5.3	6.0	50.0	21.0
0068254L	5.4	6.0	50.0	21.0
0068255L	5.5	6.0	50.0	21.0
0068255X	5.5	6.0	60.0	31.0
0068256L	5.6	6.0	50.0	21.0
0068257L	5.7	6.0	50.0	21.0
0068258L	5.8	6.0	50.0	21.0
0068259L	5.9	6.0	50.0	21.0
0068260L	6.0	6.0	50.0	21.0
0068260X	6.0	6.0	60.0	31.0

DATRON

Thread Mills

Thread Mill Parameters Tool Database 72

Thread Mill 73

Milling Thread Mill 74

Multi Thread Mill 75



DATRON

Thread Mill Parameters Tool Database

Art. No.	Nominal Diameter (mm)	Actual Diameter (mm)	RPM (1/min)	C	D3 (mm)	A/R (°)	L2 (mm)
0068418/L	0.80	0.80	35.000	40	0.49	60	0.09
0068418S	0.95	0.95	35.000	40	0.65	60	0.09
0068418	1.4	1.4	35.000	40	0.8	60	0.1
0068419L	1.4	1.4	30.000	40	0.8	60	0.1
0068419X	1.4	1.4	32.000	40	0.8	60	0.1
0068420	2.0	2.0	35.000	40	1.0	60	0.2
0068420L	2.0	2.0	30.000	40	1.0	60	0.2
0068420X	2.0	2.0	32.000	40	1.0	60	0.2
0068450	6.0	6.0	25.000	40	1.9	55	0.7
0068450A	8.0	8.0	25.000	40	3.0	55	1.55
0068451	4.0	4.08	25.000	40	1.97	60	0.5
0068451A	8.0	8.0	25.000	40	3.0	60	1.6
0068451L	4.0	4.08	22.000	40	1.97	60	0.5
0068451X	4.0	4.08	24.000	40	1.97	60	0.5
0068452	6.0	5.95	25.000	40	2.98	80	1.3

*The parameters of the thread milling cutters are only valid for HSC Pro and CNC VX.X.
The parameters are not required for the DATRON next control system.

DATRON

Milling Thread Mill Parameters Tool Database

Art. No.	Nominal Diameter (mm)	Actual Diameter (mm)	RPM (1/min)	C	D2 (mm)	A/R (°)	L2 (mm)
0068419A	2.0	2.0	45.000	40	1.34	60	0.2
0068420A	3.0	3.0	40.000	40	1.97	60	0.3
0046454	6.0	5.95	33.000	40	4.14	80	1.2
0068454A	6.0	5.95	33.000	40	2.75	60	1.2
0068456	4.8	4.6	25.000	40	3.35	60	0.5
0068457	6.0	5.95	25.000	40	4.0	60	0.5
0068458	8.0	7.95	25.000	40	5.4	60	0.5

*The parameters of the milling thread mills are only valid for HSC Pro and CNC VX.X.
The parameters are not required for the DATRON next control system.

DATRON

Multi Thread Mill Parameters Tool Database

Art. No.	Nominal Diameter (mm)	Actual Diameter (mm)	RPM (1/min)	C	D3 (mm)	A/R (°)	L2 (mm)
00684503	2.3	2.3	21.200	M3	0	60	0
00684544	3.0	2.98	14.300	M4	0	60	0
00684555	3.8	3.72	12.800	M5	0	60	0
00684566	4.5	4.48	10.850	M6	0	60	0
00684568	6.1	6.0	8.000	M8	0	60	0

*The parameters of the multi thread mills are only valid for HSC Pro and CNC VX.X.
The parameters are not required for the DATRON next control system.

DATRON

Thread Mill

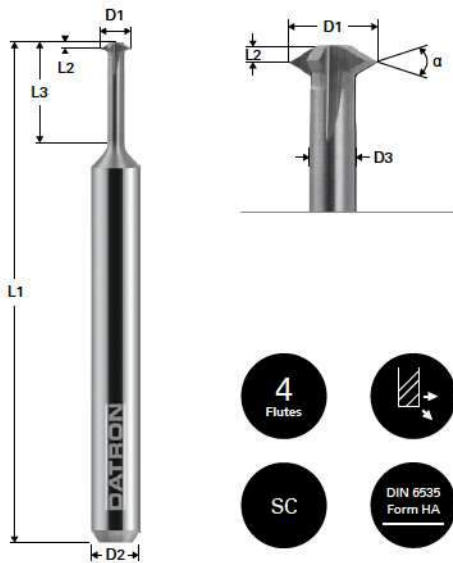

3 mm Shank								
Art. No.	Thread	D1 (mm)	D2 (mm)	D3 (mm)	L1 (mm)	L2 (mm)	L3 (mm)	α (°)
0068418	M1.0 - M 1.2	0.8	3.0	0.49	40.0	0.09	3.0	60
0068418L	M1.0 - M 1.2	0.8	3.0	0.49	40.0	0.09	6.0	60
0068418S	M1.4	0.95	3.0	0.49	40.0	0.09	3.0	60
0068419	M1.6 - M2.5	1.4	3.0	0.65	40.0	0.1	6.0	60
0068419L	M1.6 - M2.5	1.4	3.0	0.9	40.0	0.1	10.0	60
0068419X	M1.6 - M2.5	1.4	3.0	0.9	60.0	0.1	6.0	60
0068420	M2.5 - M4	2.0	3.0	0.9	40.0	0.2	8.0	60
0068420L	M2.5 - M4	2.0	3.0	1.0	40.0	0.2	12.0	60
0068420X	M2.5 - M4	2.0	3.0	1.0	50.0	0.2	8.0	60

6 mm Shank								
Art. No.	Thread	D1 (mm)	D2 (mm)	D3 (mm)	L1 (mm)	L2 (mm)	L3 (mm)	α (°)
0068451	M5 - M10	4.0	6.0	1.0	50.0	0.5	12.0	60
0068451L	M5 - M10	4.0	6.0	2.0	50.0	0.5	16.0	60
0068451X	M5 - M10	4.0	6.0	2.0	58.0	0.5	30.0	60
0068450	Whitworth < 1/2"	6.0	6.0	3.0	50.0	0.7	12.0	55
0068452	PG7 - PG48	6.0	6.0	3.0	50.0	1.3	12.0	80
0068451A	M10 - M36	8.0	6.0	3.0	50.0	1.6	12.0	60
0068450A	Whitworth < 1/2"	8.0	6.0	3.0	50.0	1.55	12.0	55

DATRON

Milling Thread Mill

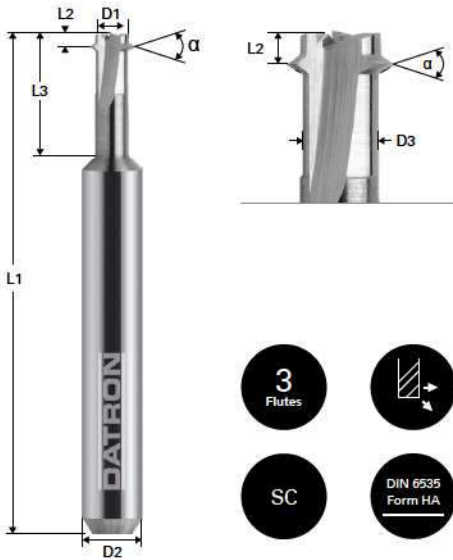

Aluminium



Brass



Plastic



Copper



Wood



3 mm Shank

Art. No.	Thread	D1 (mm)	D2 (mm)	D3 (mm)	L1 (mm)	L2 (mm)	L3 (mm)	α (°)
0068419A	M2.5 - M3	2.0	3.0	1.5	40.0	1.0	8.5	60
0068420A	M4 - M5	3.0	3.0	2.2	40.0	1.0	10.0	60

6 mm Shank

Art. No.	Thread	D1 (mm)	D2 (mm)	D3 (mm)	L1 (mm)	L2 (mm)	L3 (mm)	α (°)
0068456	M6	3.6	6.0	3.4	50.0	1.0	12.0	60
0068457	M8 - M10	4.2	6.0	4.0	50.0	1.5	12.0	60
0068454A	Metric Cable Thread	4.2	6.0	4.0	50.0	2.0	12.0	60
0068454	PG7 - PG48	4.4	6.0	4.2	50.0	2.0	12.0	80
0068458	M12 - M16	5.6	6.0	5.4	50.0	1.5	12.0	60

DATRON

Multi Thread Mill

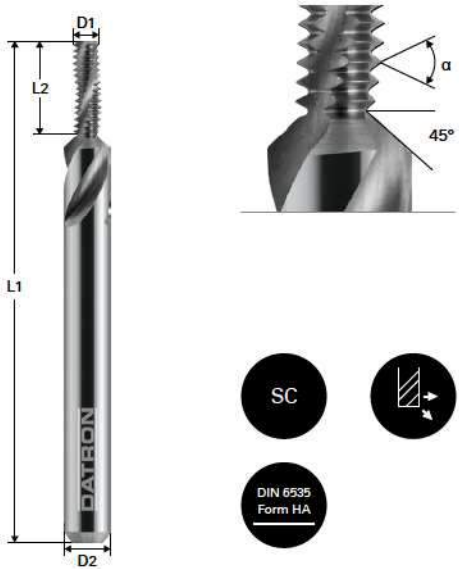

Aluminium Plastic



Brass



6 mm Shank

Art. No.	Thread	D1 (mm)	D2 (mm)	L1 (mm)	L2 (mm)	α (°)
00684503	M3	2.3	6.0	50.0	8.0	60
00684504	M4	3.0	6.0	50.0	8.0	60
00684544	M4	3.0	6.0	50.0	12.0	60
00684505	M5	3.8	6.0	50.0	12.0	60
00684555	M5	3.8	6.0	50.0	16.0	60

8 mm Shank

Art. No.	Thread	D1 (mm)	D2 (mm)	L1 (mm)	L2 (mm)	α (°)
00684506	M6	4.5	8.0	50.0	12.0	60
00684566	M6	4.5	8.0	50.0	16.0	60

10 mm Shank

Art. No.	Thread	D1 (mm)	D2 (mm)	L1 (mm)	L2 (mm)	α (°)
00684508	M8	6.0	10.0	50.0	12.0	60
00684588	M8	6.0	10.0	50.0	16.0	60

DATRON

External Radius End Mills

External Radius End Mill 78

External Radius End Mill, Polished
for Acrylic Glass 79

Deburring End Mill, Two Flutes 80

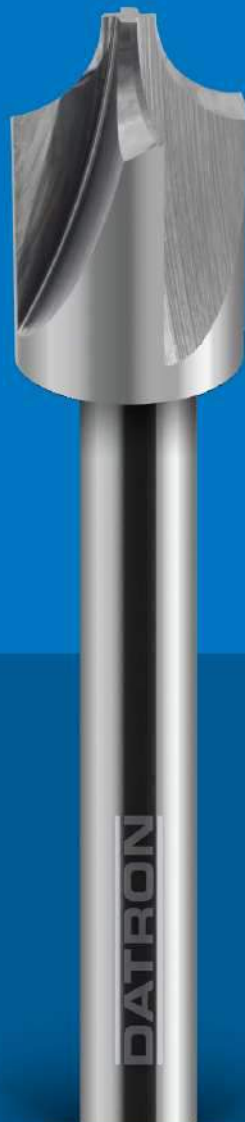

DATRON

External Radius End Mill

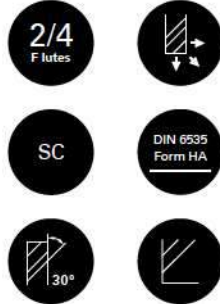
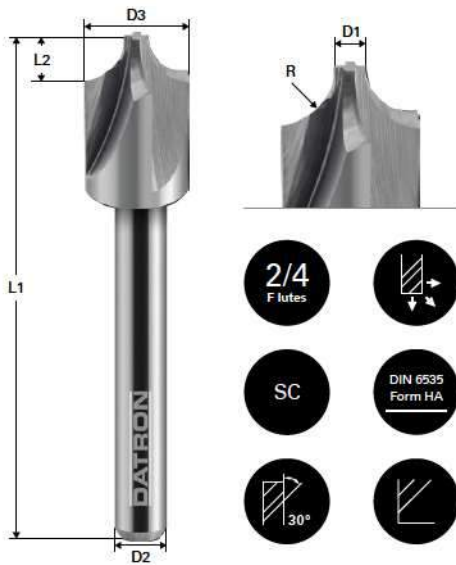

Aluminium



Plastic



Wood



Bronze



Brass



6 mm Shank

Art. No.	D1 (mm)	D2 (mm)	D3 (mm)	L1 (mm)	L2 (mm)	R (mm)	Number of Flutes
0068412	2.0	6.0	6.0	50.0	2.0	2.0	2
00684115	3.0	6.0	6.0	50.0	1.5	1.5	2
00684125	3.0	6.0	8.0	50.0	2.5	2.5	4
00684145	3.0	6.0	12.0	50.0	4.5	4.5	4
0068415	3.0	6.0	13.0	50.0	5.0	5.0	4
0068411	4.0	6.0	6.0	50.0	1.0	1.0	2
0068413	4.0	6.0	10.0	50.0	3.0	3.0	4
00684135	4.0	6.0	11.0	50.0	3.5	3.5	4
0068414	4.0	6.0	12.0	50.0	4.0	4.0	4
0068416	4.0	6.0	16.0	50.0	6.0	6.0	4
0068410	5.0	6.0	6.0	50.0	0.5	0.5	2

DATRON

External Radius End Mill Polished for Acrylic Glass



- 3
Flutes
- Right-hand flute
- SC
- DIN 6535
Form HA



Acrylic Glass



Plastic



6 mm Shank						
Art. No.	D1 (mm)	D2 (mm)	D3 (mm)	L1 (mm)	L2 (mm)	R (mm)
00685710	4.0	6.0	6.0	50.0	1.0	1.0
00685720	4.0	6.0	8.0	50.0	2.0	2.0
00685730	4.0	6.0	10.0	50.0	3.0	3.0
00685715	5.0	6.0	8.0	50.0	1.5	1.5
00685725	5.0	6.0	10.0	50.0	2.5	2.5

DATRON

Deburring End Mill Two Flutes



Steel



3 mm Shank

Art. No.	D1 (mm)	D2 (mm)	L1 (mm)	L2 (mm)	R (mm)
00784908	0.8	3.0	40.0	0.3	0.3
00784909	0.9	3.0	40.0	0.3	0.3
00784910	1.0	3.0	40.0	0.3	0.3
00784911	1.1	3.0	40.0	0.3	0.3
00784912	1.2	3.0	40.0	0.3	0.3
00784913	1.3	3.0	40.0	0.3	0.3
00784914	1.4	3.0	40.0	0.3	0.3
00784915	1.5	3.0	40.0	0.3	0.3
00784916	1.6	3.0	40.0	0.3	0.3
00784917	1.7	3.0	40.0	0.3	0.3
00784918	1.8	3.0	40.0	0.3	0.3
00784919	1.9	3.0	40.0	0.3	0.3
00784920	2.0	3.0	40.0	0.3	0.3
00784921	2.1	3.0	40.0	0.3	0.3
00784922	2.2	3.0	40.0	0.3	0.3
00784923	2.3	3.0	40.0	0.3	0.3
00784924	2.4	3.0	40.0	0.3	0.3

DATRON

Standard Engraving Tools

Standard Engraving Tool	82
Standard Engraving Tool, Specially Balanced	84
Standard Engraving Tool for Steel Machining	85
Standard Engraving Tool for Hard Metal Machining with Coating (ALCRONA)	86

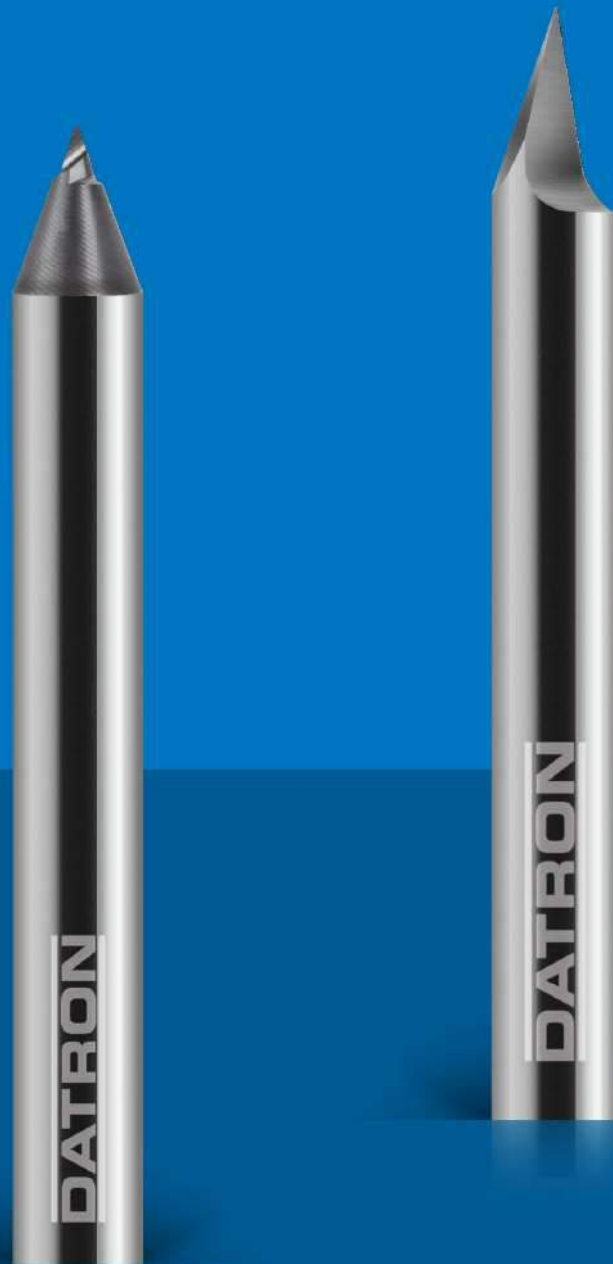

DATRON

Standard Engraving Tool

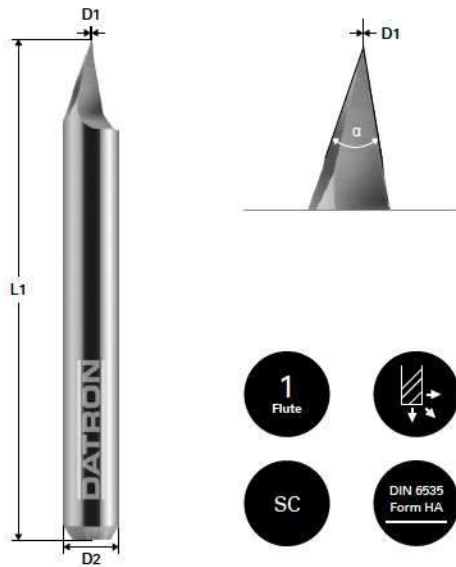

Aluminium

Bronze

Plastic



Copper

Brass



Wood



Acrylic Glass



3 mm Shank

Art. No.	D1 (mm)	D2 (mm)	L1 (mm)	α (°)
0068278	0.05	3.0	40.0	20
0068279	0.1	3.0	40.0	20
0068279A	0.1	3.0	40.0	30
0068280	0.1	3.0	40.0	40
0068280A	0.1	3.0	40.0	45
0068281	0.1	3.0	40.0	60
0068282	0.1	3.0	40.0	90
0068278A	0.2	3.0	40.0	20
0068279B	0.2	3.0	40.0	30
0068280B	0.2	3.0	40.0	40
0068281A	0.2	3.0	40.0	60
0068280D	0.5	3.0	40.0	40
0068284	3.0	3.0	40.0	180

1/8" Shank

Art. No.	D1 (mm)	D2 (mm)	L1 (mm)	α (°)
0068679	0.1	3.175	40.0	20
0068679A	0.1	3.175	40.0	30
0068680	0.1	3.175	40.0	40
0068681	0.1	3.175	40.0	60
0068682	0.1	3.175	40.0	90

4 mm Shank

Art. No.	D1 (mm)	D2 (mm)	L1 (mm)	α (°)
0068270	0.1	4.0	40.0	20
0068273	0.1	4.0	40.0	30
0068274	0.1	4.0	40.0	40
0068276	0.1	4.0	40.0	60
0068277	0.1	4.0	40.0	90

6 mm Shank

Art. No.	D1 (mm)	D2 (mm)	L1 (mm)	α (°)
0068284B	0.05	6.0	50.0	20
0068284C	0.1	6.0	50.0	20
0068283	0.1	6.0	50.0	30
0068283L	0.1	6.0	50.0	40
0068285	0.1	6.0	50.0	50
0068285A	0.1	6.0	50.0	60
0068286	0.1	6.0	50.0	90
0068287	0.1	6.0	50.0	120
0068284D	0.2	6.0	50.0	20
0068283D	0.2	6.0	50.0	30
0068285D	0.2	6.0	50.0	60
0068283E	0.3	6.0	50.0	30
0068285E	0.3	6.0	50.0	60
0068284F	0.4	6.0	50.0	20
0068283F	0.4	6.0	50.0	30
0068285F	0.4	6.0	50.0	60
0068283G	0.6	6.0	50.0	30
0068288	6.0	6.0	50.0	180

DATRON

Standard Engraving Tool Specially Balanced

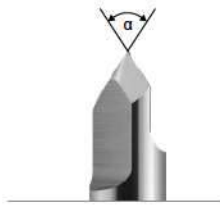
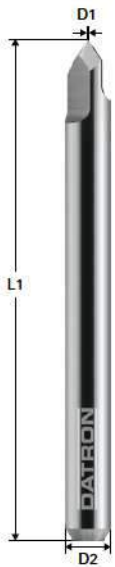

6 mm Shank					
Art. No.	D1 (mm)	D2 (mm)	L1 (mm)	α (°)	
0068282G	0.1	6.0	50.0	30	
0068284G	0.1	6.0	50.0	40	
0068285G	0.1	6.0	50.0	60	
0068286G	0.1	6.0	50.0	90	

DATRON

Standard Engraving Tool for Steel Machining



Steel



6 mm Shank

Art. No.	D1 (mm)	D2 (mm)	L1 (mm)	α (°)
0068510	0.1	6.0	50.0	20
0068511	0.1	6.0	50.0	30
0068512	0.1	6.0	50.0	40
0068513	0.1	6.0	50.0	60
0068514	0.1	6.0	50.0	90
0068510A	0.2	6.0	50.0	20
0068511A	0.2	6.0	50.0	30
0068512A	0.2	6.0	50.0	40
0068513A	0.2	6.0	50.0	60
0068514A	0.2	6.0	50.0	90

DATRON

Standard Engraving Tool for Hard Metal Machining with Coating (ALCRONA)



Steel



Bronze



GRP/CRP



4 mm Shank

Art. No.	D1 (mm)	D2 (mm)	L1 (mm)	α (°)
0068520	0.1	4.0	40.0	30
0068521	0.1	4.0	40.0	45
0068520A	0.2	4.0	40.0	30
0068521A	0.2	4.0	40.0	45

DATRON

T-Slotting Mills

T-Slotting Mill

88

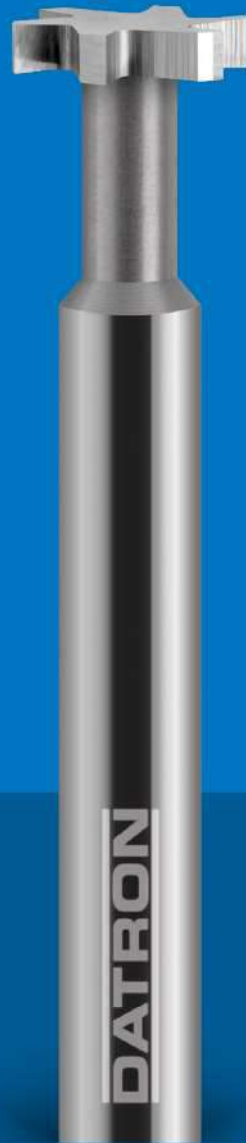

DATRON

T-Slotting Mill



Aluminium



Plastic



Wood



Bronze



Brass



Art. No.	D1 (mm)	D2 (mm)	D3 (mm)	L1 (mm)	L2 (mm)	L3 (mm)	Number of Flutes
0068425	3.0	3.0	1.6	40.0	0.8	6.0	2
0068424D	6.0	6.0	3.0	50.0	2.8	8.0	4
0068424L	8.0	6.0	3.5	50.0	0.7	6.0	4
0068424K	8.0	6.0	3.5	50.0	1.0	6.0	4
0068424	8.0	6.0	3.5	50.0	1.3	6.0	4
0068424S	8.0	6.0	3.5	50.0	4.5	9.0	4
0068423	10.0	6.0	4.0	50.0	2.0	12.0	4
0068423A	10.0	6.0	4.0	50.0	2.0	12.0	6
0068426	15.0	6.0	6.0	50.0	3.0	25.0	4
0068424A	8.0	8.0	3.5	50.0	1.3	6.0	4

DATRON

Dovetail Milling Tools

Dovetail Milling Tool

90



DATRON

Dovetail Milling Tool

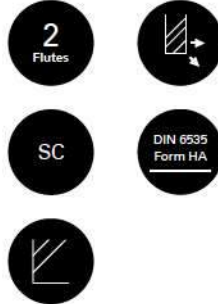
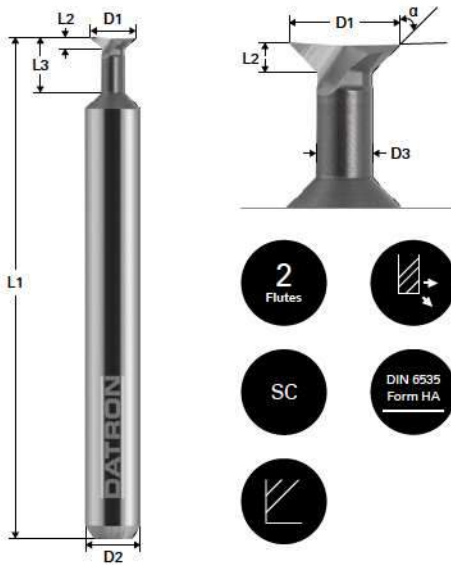

Aluminium



Plastic



Wood



Bronze



Brass



Art. No.	D1 (mm)	D2 (mm)	D3 (mm)	L1 (mm)	L2 (mm)	L3 (mm)	α (°)
0068290	3.0	3.0	2.0	40.0	3.0	6.0	5
0068783	3.0	3.0	2.0	40.0	0.87	6.0	30
0068783A	3.0	3.0	2.0	40.0	0.5	6.0	45
0068783B	3.0	3.0	2.0	40.0	0.29	6.0	60
0068690	3.175	3.175	2.0	39.0	3.0	6.0	5
0068784	4.0	6.0	2.0	50.0	1.73	6.0	30
0068784A	4.0	6.0	2.0	50.0	1.0	6.0	45
0068784B	4.0	6.0	2.0	50.0	0.58	6.0	60
0068785	5.0	6.0	2.5	50.0	2.17	6.0	30
0068785A	5.0	6.0	2.5	50.0	1.25	6.0	45
0068785B	5.0	6.0	2.5	50.0	0.72	6.0	60
0068291	6.0	6.0	5.0	50.0	6.0	6.0	5
0068786	6.0	6.0	3.0	50.0	2.6	6.0	30
0068786A	6.0	6.0	3.0	50.0	1.5	6.0	45
0068786B	6.0	6.0	3.0	50.0	0.87	6.0	60

DATRON

Tool Clamping Technology

HSK Clamping System

Polygon Clamping Technology	92
DATRON HSK-E Collets	93
DATRON Clamping Device	94
DATRON Reduction Inserts	94

Direct Clamping System

DATRON Adapter Collets	95
DATRON Insertion Tools and Limit Stop Rings	95

DATRON

Polygon Clamping Technology

The HSK-E polygon collet chucks have been developed for precise and safe cutting, also at high speeds.

The stable, rotation-symmetrical design has an excellent concentricity of less than $3\mu\text{m}$. This permits high quality milling results at a speed of up to 48,000 RPM.

With passive vibration damping, the life of the high frequency spindle and the cutting tool is significantly improved.



Functional Principle of the Polygonal Clamping Technology

Clamping Diameter Polygonal

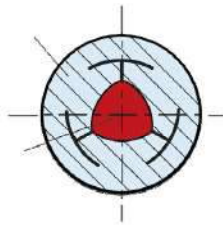

1. Before Clamping

The polygon-shaped geometry of the shank insert can be clearly seen in the unloaded, relieved state.

Clamping Diameter is Round

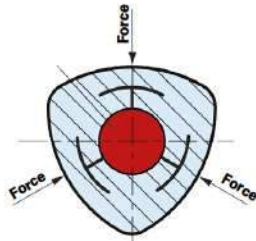

2. In the Clamping Fixture

Force is applied at three points by means of the hydraulic clamping fixture. This makes the shank insert circular.

Joining Shank

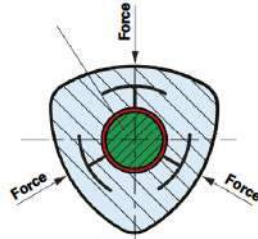

3. Inserting the Tool Shank

Now the tool shank can be easily and quickly mounted in the insert.

Clamping Diameter Shrinks

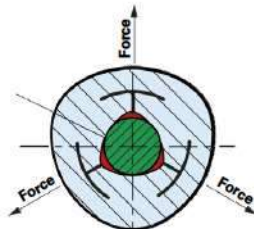

4. The Tool is Clamped

The pressure of the clamping fixture and the force transmission are reduced. The elastically deformed collet chuck comes back to its polygon shape. Now the tool is firmly and centrally clamped.

DATRON

HSK-E Collets

The HSK-E inserts offered by DATRON are solidly built and come with a concentricity of <math><3\mu\text{m}</math> and guarantee highest precision during the machining process.



Art. No.	D1 (mm)	D2 (mm)	D3 (mm)	L1 (mm)	L2 (mm)
0068300G	3.0	20.0	HSK-E 25	40.0	30.0
0068300S	3.0	14.0	HSK-E 25	40.0	30.0
0068311D	3.175	20.0	HSK-E 25	40.0	30.0
0068301G	4.0	20.0	HSK-E 25	40.0	30.0
0068302G	5.0	20.0	HSK-E 25	40.0	30.0
0068303G	6.0	20.0	HSK-E 25	40.0	30.0
0068303S	6.0	14.0	HSK-E 25	40.0	30.0
0068304G	8.0	20.0	HSK-E 25	40.0	30.0
0068305G	10.0	20.0	HSK-E 25	40.0	30.0
0068300V	3.0	20.0	HSK-E-32	50.0	30.0
0068301V	4.0	20.0	HSK-E-32	50.0	30.0
0068302V	5.0	20.0	HSK-E-32	50.0	30.0
0068303V	6.0	20.0	HSK-E-32	50.0	30.0
0068307I	6.0	25.0	HSK-E-32	55.0	35.0
0068308I	8.0	25.0	HSK-E-32	55.0	35.0
0068309I	10.0	25.0	HSK-E-32	55.0	35.0
0068310I	12.0	25.0	HSK-E-32	55.0	35.0

DATRON

Clamping Device

The hydraulic clamping fixture for polygon clamping technique, equipped with hand pump and manometer, does not require any source of energy and can therefore be used in a very flexible manner. Just a few steps are required for the clamping process. Clamping is completed within 20 seconds.

Compared to the shrink technique, this wear-free process does not require any heating up or cooling down phases.



Art. No.	Article Description		
0068340	Clamping Device	20	HSK-E 25

DATRON

Reduction Inserts

The reducing inserts allow the use of different HSK collet chucks on the clamping device.

Art. No.	Article Description	for D2	Adapter Type
0068341S	Reduction Insert	14	HSK-E 25
0068341D	Reduction Insert	20	HSK-E 25
0068341E	Reduction Insert	25	HSK-E 32



DATRON

Adapter Collets

With the DATRON adapter collets you may use different tool shank diameters in one spindle collet chunk only. The adapters are pre-pressed and therefore reusable. To open the adapter collets you need the DATRON adapter insertion tool Art. No. 0068337D for 6mm and 8mm adapters.



Art. No.	D1 (mm)	D2 (mm)	D3 (mm)
0068336G	1.0	6.0	7.55
0068336H	1.1	6.0	7.55
0068336J	1.2	6.0	7.55
0068336K	1.3	6.0	7.55
0068336L	1.4	6.0	7.55
0068336M	1.5	6.0	7.55
0068336N	1.6	6.0	7.55
0068336P	1.7	6.0	7.55
0068336Q	1.8	6.0	7.55
0068350	1/8"	6.0	7.55
0068350A	1/8"	6.35	7.55

Art. No.	D1 (mm)	D2 (mm)	D3 (mm)
0068350C	1/8"	8.0	10.5
0068336B	2.0	6.0	7.55
0068336A	2.0	8.0	10.5
0068336	3.0	6.0	7.55
0068336C	3.0	8.0	10.5
0068350D	4.0	6.0	7.55
0068336D	4.0	8.0	10.5
0068336R	5.0	8.0	10.5
0068336F	6.0	8.0	10.5
0068337D	Adapter Insertion Tool for 6 mm and 8 mm Collet Chucks		

DATRON

Limit Stop Rings and Insertion Tool

The limit stop rings are used to fasten the tool shafts in the automatic tool change. To push the rings on the 6mm and 8mm shanks we recommend the DATRON insertion tool.



Art. No.	D1 (mm)	D2 (mm)	Material	Limit Stop Ring
0068000	3.0	7.55	Plastic	For Tool Change Station 0069220
0068000Y	4.0	10.50	Brass	For Tool Change Station 0069220
0068001	3.175	7.55	Plastic	For Tool Change Station 0069220
0068002	6.0	10.50	Brass	For Tool Change Station 0069221
0068002H	6.0	15.00	Brass	For Tool Change Station 0069223
0068002J	6.0	18.00	Brass	For Tool Change Station 0069227
0068002Z	6.35	10.50	Brass	For Tool Change Station 0069221
0068001D	8.0	12.50	Brass	For Tool Change Station 0069222
0068002K	8.0	18.00	Brass	For Tool Change Station 0069227
0068180	Limit Stop Ring Insertion Tool for 6 mm Shank Tools			
0068180A	Limit Stop Ring Insertion Tool for 8 mm Shank Tools			

DATRON

Expendable Material

VacuCard	98
----------	----

Cooling Lubricants	100
--------------------	-----

DATRON
VacuCard

This paperboard serves as the “sacrificial layer” during vacuum clamping. This special fabric structure distributes the vacuum homogeneously and ensures a uniform suction force over the entire clamping surface.

- Distributes vacuum homogeneously
- Uniform suction force
- Format matches the DATRON vacuum plates



Art. No.	Article Description	Unit per PU	Size (mm)
0A01616*	VacuCard	50	450 x 650 x 0.7
0A01617*	VacuCard	50	500 x 1,000 x 0.7
0A01617A*	VacuCard	50	700 x 1,000 x 0.7
0A01617I*	VacuCard (neo)	50	500 x 200 x 0.7
0A01617K*	VacuCard (neo)	50	500 x 400 x 0.7

* from 4 PU freight costs are incurred

DATRON
VacuCard++ Defies the Rules of Physics

Clamping of small parts with vacuum

What is VacuCard++?

VacuCard++ is a special, patent-pending paperboard which is used as a sacrificial layer between the work piece and the vacuum plate. Unlike the DATRON VacuCard, the VacuCard++ has an additional grid-like sealing/adhesive layer that significantly increases the holding force during vacuum clamping and considerably reduces vacuum loss.

For Which Applications can the VacuCard++ be Used?

- Milling small parts made of plate material
- Consolidated PCB machining without separating webs
- Milling thin and soft plate material
- Milling plate material with a rough surface

How does the VacuCard++ Work?

- The sealing/adhesive layer holds parts that are so small that vacuum alone would not be enough to hold them
- Increases the holding force during vacuum clamping with suction-cup effect

- Prevents work pieces from slipping when large milling forces are used
- Reduces the vacuum consumption and prevents early collapse
- Distributes the vacuum evenly over the work piece
- Prevents raising of edges in soft and flexible work pieces
- Machined work pieces can be removed without any residue

Technical Data

- Paperboard with redundant suction-cup effect due to a grid-like sealing/adhesive layer
- Combination of adhesion and vacuum clamping
- Reduced vacuum consumption due to limited air permeability and protective film cover
- Disposed of as paper waste
- Durability depends on the storage

The patented VacuCard++ is based on the standard VacuCard and has a grid-like adhesive structure. Thanks to this special adhesive layer, the VacuCard++ has a considerably higher combined clamping force and fixes even small, light parts with high process reliability.

- Grid-like adhesive layer (10 mm x 10 mm)
- Delicate parts are firmly clamped
- Homogeneous vacuum distribution
- Format matches the DATRON vacuum plates

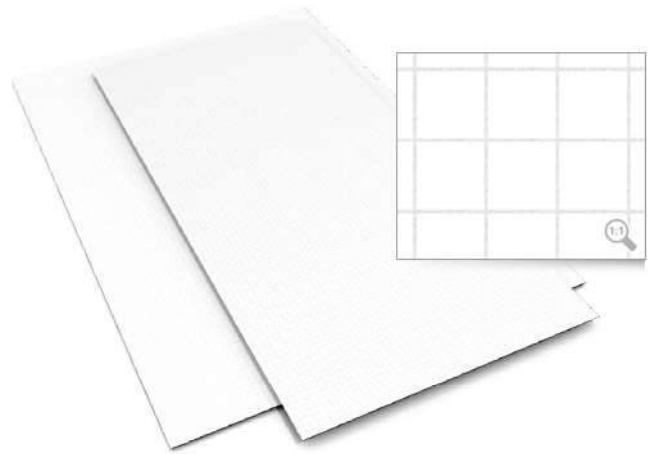

Art. No.	Article Description	Unit per PU	Size (mm)
0A01618G*	VacuCard++	10	450 x 650 x 0.7
0A01618D*	VacuCard++	50	450 x 650 x 0.7
0A01618H*	VacuCard++	10	500 x 1,000 x 0.7
0A01618E*	VacuCard++	50	500 x 1,000 x 0.7
0A01618I*	VacuCard++	10	700 x 1,000 x 0.7
0A01618F*	VacuCard++	50	700 x 1,000 x 0.7

* from 4 PU freight costs are incurred

DATRON VacuCard+++

DATRON VacuCard+++

The patented VacuCard+++ is based on the standard VacuCard and has a grid-like adhesive structure (5 mm x 5 mm). Thanks to this special adhesive layer, the VacuCard+++ has a considerably higher combined clamping force and fixes even small, light parts up to 10 mm diameter with high process reliability.

- Grid-like adhesive layer (5 mm x 5 mm)
- Smallest parts are firmly clamped
- Homogeneous vacuum distribution
- Format matches the DATRON vacuum plates

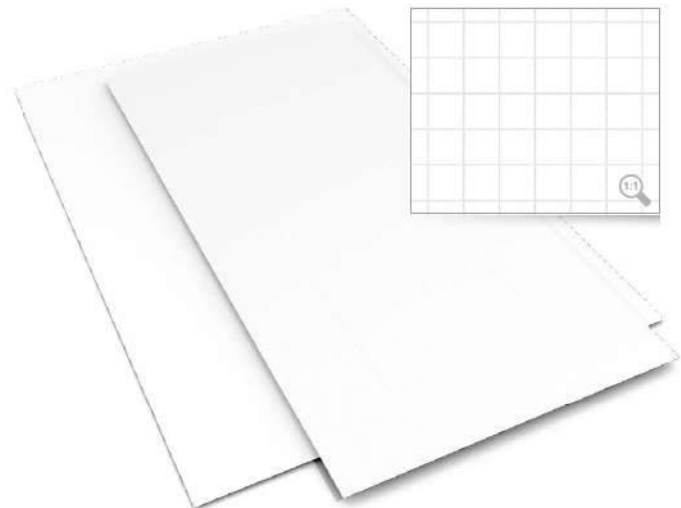

Art. No.	Article Description	Unit per PU	Size (mm)
0A01618M*	VacuCard+++	10	500 x 1,000 x 0.7
0A01618K*	VacuCard+++	100	500 x 1,000 x 0.7
0A01618N*	VacuCard+++	10	700 x 1,000 x 0.7
0A01618W*	VacuCard+++ (neo)	20	500 x 400 x 0.7

* from 4 PU freight costs are incurred

DATRON

Cooling Lubricants for Minimum Lubrication

Beyond CNC machines and tools, DATRON is now also offering the appropriate cooling lubricants. These new cooling lubricants, called ProCut, are only appropriate for minimum lubrication. Due to the very low consumption, this puts the price per liter into perspective. In addition, operating and personnel costs for the machine and part cleaning are saved to a great degree, as well as, for example, changing the lubricant. DATRON is still offering minimum lubrication systems for Microjet, which optimally moisten the workpieces with their flexibly adjustable spray nozzles.



Art. No.

Package Size
(L)

0069266

10

DATRON ProCut 56

ProCut 56 is made of pure hydrocarbon and works as a replacement for ethanol. It shows its strengths in the machining of workpieces made of aluminium and plastics, especially in conjunction with DATRON's CleanCut chip extraction. The lubricant allows burr-free machining of the workpieces. It also prevents the formation of material work-ups on the tool. No explosion protection is required for chip extraction. ProCut 56 is completely volatile and leaves no residue on the workpiece. Thus, this MM-lubricant is especially appropriate for companies or departments where the use of ethanol is not allowed and for machining materials that react aggressively when in contact with ethanol. No further cleansing is required with this cooling lubricant.

Consumption without CleanCut: **80 ml/hour**
(about. 30% of ethanol consumption)
CleanCut consumption: **270 ml/hour**



Art. No.

Package Size
(L)

0069266A

10

DATRON ProCut 56-2

ProCut 56-2 is made of pure hydrocarbon with light lubrication and works as a replacement for ethanol. It is designed for Plexiglas machining or for materials with high surface quality. Thus, this MM-lubricant is especially appropriate for companies or departments where the use of ethanol is not allowed and for workpieces requiring high surface quality. Cleansing is required with this cooling lubricant.

Consumption without CleanCut: **95 ml/hour**
CleanCut consumption: **200 ml/hour**



DATRON ProCut 200

The lubricant ProCut 200 was specially developed for steel machining. Significantly longer tool durability is achieved when machining hard materials with the help of this very yielding MM lubricant. Final cleaning is required with this cooling lubricant.

Consumption: **20 ml/hour**

Art. No.	Package Size (L)
0069266B	10
0069266D	5

DATRON

General Information

ToolTechnology	104
Coatings	105
Guide Values for Speed and Feed	106
Competence Center Tools	107
Individual Tools	107

DATRON

Tool Technology



Quality and Precision "Made in Germany":

The tools are manufactured on top-of-the-range, fully automatic grinding machines which results in constant high quality and an excellent price/efficiency ratio. Permanent quality control and research on our inhouse milling machines – also under extreme milling conditions – are your guarantee for the extraordinary quality and efficiency of the DATRON tools.

- Development
- Testing
- Production
- Drilling from 0.1 mm
- Milling from 0.1 mm
- Thread Milling from M1



Profitability:

Using DATRON's high-quality micrograin Solid Carbide tools will result in especially long tool life.

The tool's efficiency is further increased by a new coating.

- Maximum milling ability
- Maximum tool life
- Maximum process reliability



DATRON Technology:

The cutting geometry of the DATRON milling tools contains the DATRON know-how of more than 25 years in HSC cutting. Constant advancement and optimisation stand for state-of-the-art tools.

- Intelligent geometry
- Latest grinding machines
- Top-quality micro-grain Solid Carbide

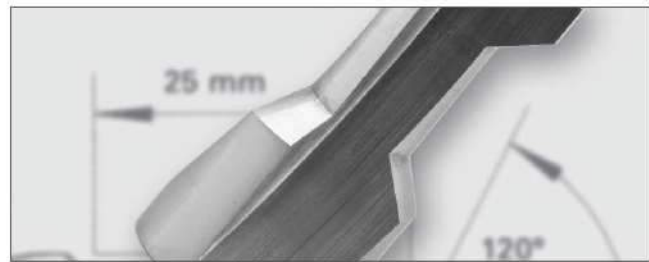

Individual Tool Service:

DATRON special-purpose tools will solve your machining problem! On the basis of your drawings or specifications we will manufacture a Solid Carbide special-purpose tool in the high DATRON quality you can expect. Here we offer e. g. special mills for musical instruments, multi-level drills and special tools for forms and moulds.

Coatings

BALINIT® X.CEED Coating

Hardness and High Coating Adhesion



Layer properties	
Material	AlTiN
Micro hardness	3,300 HV
Frictional value	0.4 (dry against steel)
Max. application temperature	900°C
Colour	blue-gray

Hardness, oxidation-resistance and thermal stability of X.CEED have been optimised for use in hard and high-speed machining. Even for high-strength and hard-to-cut materials, the layer protects against abrasion and adhesion over the entire cutting speed range. The good sliding properties reduce the cutting forces.

BALINIT® ALCRONA Coating

Low Frictional Value and Hot Hardness



Layer properties	
Material	AlCrN
Micro hardness	3,200 HV
Frictional value	0.35 (dry against Steel)
Max. application temperature	1,100°C
Colour	light-gray

Excellent wear-resistance, thermal shock stability and hot hardness – those are the properties, which have been decisively modified, in order to further improve the proven ALCRONA layer. By optimising the process parameters and modifying the layer structure, the performance profile of the new layer is significantly increased. ALCRONA is the new top allrounder in chip removal.

BALINIT® ALNOVA Coating

High Thermal Shock Resistance, Good Chip Removal



Layer properties	
Material	AlCrN based
Micro hardness	3,200 HV
Frictional value	0.3 (dry against Steel)
Max. application temperature	>1,100°C
Colour	light-gray

BALINIT® ALNOVA is especially characterized by optimal layer adhesion, high thermal shock resistance, good chip removal and extremely high tool stability at the cutting edges. With its extremely sturdy and smooth surface, the coating is ideally suited for tools exposed to very high machining temperatures.

Diamond Coating

High Hardness and Chemical Resistance



Layer properties	
Material	Diamond
Micro hardness	10,000 HV
Frictional value	0.4 (dry against Steel)
Max. application temperature	700°C
Colour	dark-gray

The unique material properties of multilayer diamond coatings offer considerable performance potential, which can be used for machining graphite as well as carbide and ceramic green compacts. These highly abrasive materials can be machined very efficiently today, thanks to exactly constructed CVD diamond layers on carbide.

DATRON

Guide Values for Speed and Feed

Formulas for Calculating the Milling Parameters	
Formula	Parameter
<p>Cutting Speed</p> $V_c = \frac{\pi * d * n}{1000}$	<p>V_c = Cutting Speed (mm/min) d = Tool Diameter (mm) n = Speed (rpm)</p>
<p>Feed Speed</p> $V_f = f_z * n * z$	<p>v_f = Feed Speed (mm/min) f_z = Tooth Feed (mm/min) n = Speed (rpm) z = Tooth Number (-)</p>
<p>Cutting Capacity</p> $P_c = \frac{Q}{V_{sp}}$	<p>P_c = Cutting capacity (kW) Q = Chip Volume per Unit Time (cm³/min) V_{sp} = spec. Chip-Cutting Volume (cm³/min/kW)</p>
<p>Chip Volume per Unit Time</p> $Q = a_e * a_p * v_f$	<p>Q = Chip Volume per Unit Time (cm³/min) a_e = Radial Working Engagement (mm) a_p = Cutting Depth (mm) v_f = Feed Speed (mm/min)</p>

Machining of Plastics

When machining plastics, such as duroplasts and thermoplasts, generally select lower speeds and higher feeds as compared to aluminium.

Engraving with Engraving Tools

Select the following values for engraving aluminium or brass with a graver:
 Speed approx. 30,000 rpm
 Feed approx. 0.7 m/min

DATRON

Competence Center Tools

In order to consult you individually, we have established the DATRON Competence Center Tools (CCT). This specialist team is your first and central contact for all technical inquiries regarding tools.

DATRON

Individual Tools

Do you need a special tool? This is no problem at DATRON!

DATRON produces individual tools for your special application reflecting your requirements. These tools represent DATRON top quality being manufactures according to your drawings/ specifications on the most modern, fully automatic grinding machines. Examples are stepped milling tools, stepped drills, special form and micro tools.

Simply enter your data in the table below and send it to us via fax or e-mail.

By fax to: +49 (0)6151-14 19-39
By e-mail to: cct@datron.de

Name	Your Individual Data
Milling Tool Comparable with Article Number	Art. No.:
D1 Cutting Edge Diameter	
D2 Shank Diameter	
D3 Toric Cut Diameter	
L1 Total Length*	
L2 Cutting Edge Length	
L3 Effective Length, Toric Cut	
R Radius	
CT Coating	

* The total length L1 can vary.

Remarks



PLACE YOUR ORDER NOW:



By E-Mail: tools@datron.de



Order Hotline: +49 (0)6151-1419-111

Tool Consultancy/Competence Center Tools: +49 (0)6151-1419-480



or by Fax: +49 (0)6151-1419-39

© 2017 DATRON AG

Please see our "safety rules to operate the machine". They can be requested from DATRON or viewed at www.safety.datron.de.

The information in this brochure contains current descriptions or performance features which are subject to change due to further development of the products. Some product images might include optional components. The descriptions and performance features are binding only if they are expressly agreed in writing at the time of conclusion of the contract.

All content in this brochure is the property of DATRON AG or its licensors and is subject to intellectual and industrial property rights of the copyright holders. If you copy this content, print it or make it in any form available, you agree to recognize all trademarks, copyrights and other proprietary rights. You further agree not to edit aforementioned content. With the exception of aforesaid limited right of use DATRON AG does not grant you any explicit or implicit rights or licences under any trademark, copyright or other rights in relation to intellectual or industrial property. DATRON, DATRON neo and DATRON next are registered trademarks of DATRON AG. DATRON neo is a registered design patent.

DATRON AG
In den Gänsäckern 5
64367 Mühlthal, Germany

Tel.: +49(0)6151-1419-0
Fax: +49(0)6151-1419-29
www.datron.de