

**|BGFIX<sup>®</sup>|**





## Stairway 1 m

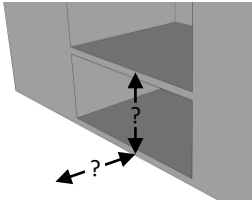
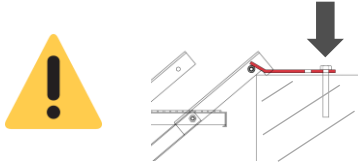
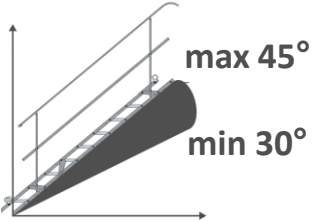

**|BGFIX<sup>®</sup>|**

General Information

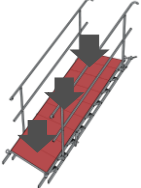
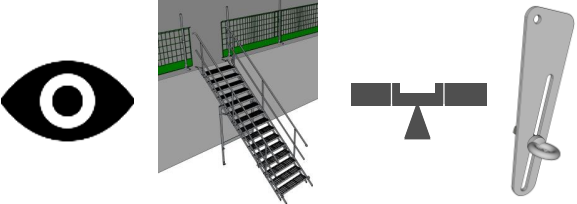
**EN 12811-1:2003**

<p>Work safe</p>	
<p>Check the distance and the height</p>	
<p>Anchor the stairway</p>	
<p>Inclination: min 30° - max 45°</p>	
<p>Point load: max. 150 kg</p>	
<p>Distributed load: ≤100 kg/m2</p>	
<p>Check the stairway</p>	
<p>Remove dirt and snow</p>	

Product Overview

**Stairway 1 m / 3 steps**  
**Weight: 45 kg**

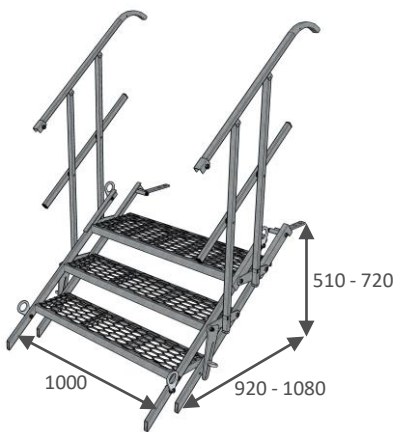

mm

**Stairway 1 m / 6 steps**  
**Weight: 73 kg**

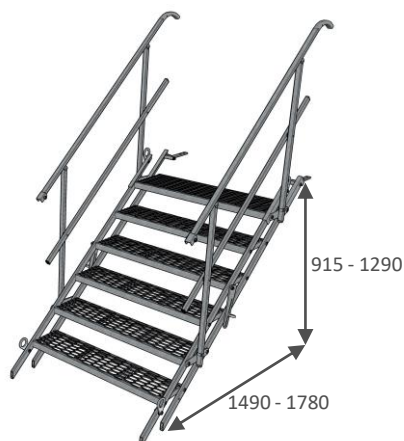

mm

**Stairway 1 m / 9 steps**  
**Weight: 99 kg**

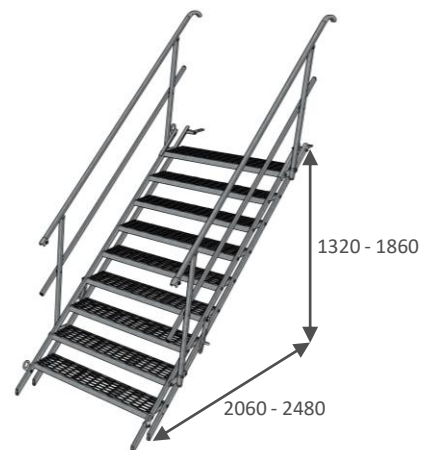

mm

**Stairway 1 m / 12 steps**  
**Weight: 132 kg**

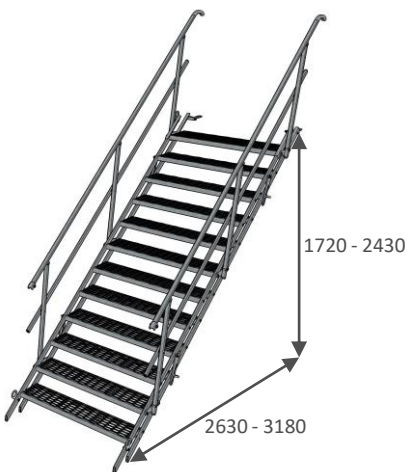

mm

**Stairway 1 m / 15 steps**  
**Weight: 175 kg**

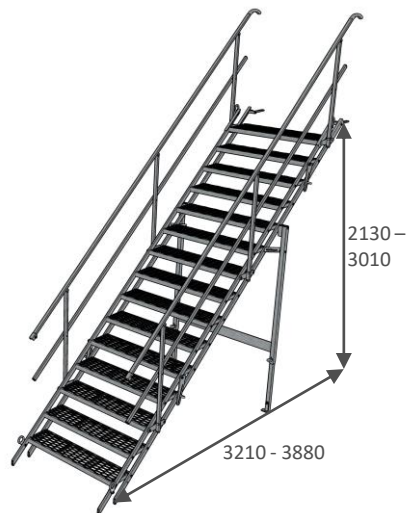

mm

**Stairway 1 m / 18 steps**  
**Weight: 208 kg**

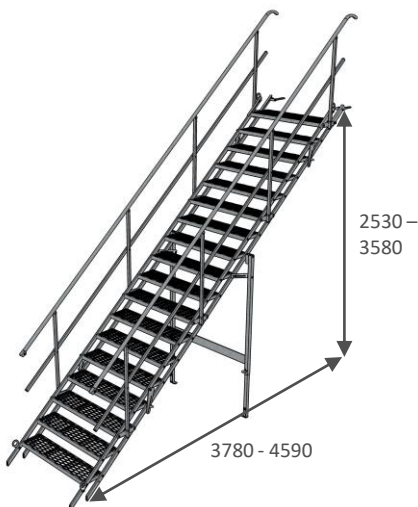

mm

Assembling

1

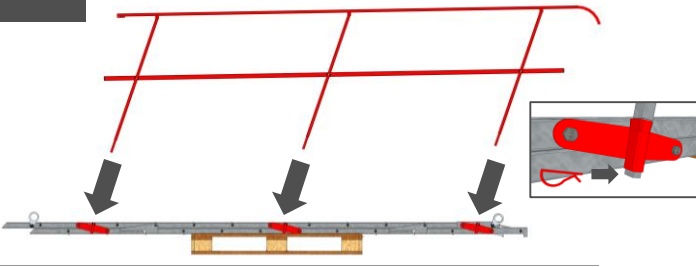

2

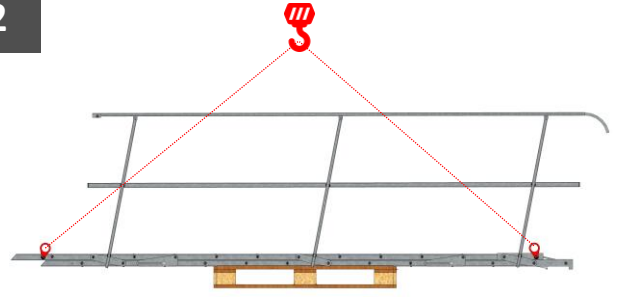

cran for  $\geq 12$  steps

3

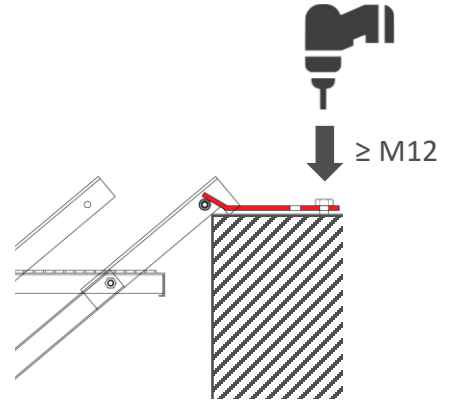
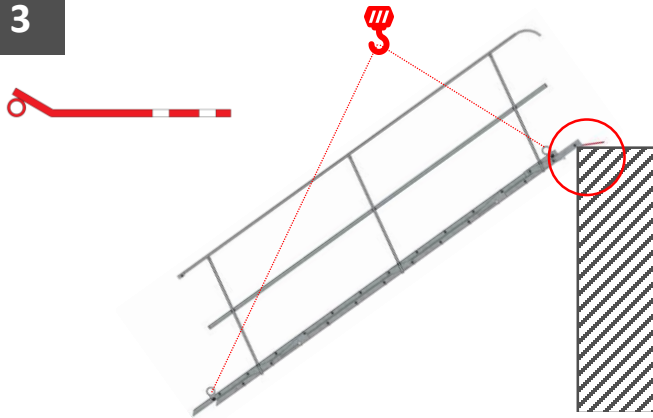

4

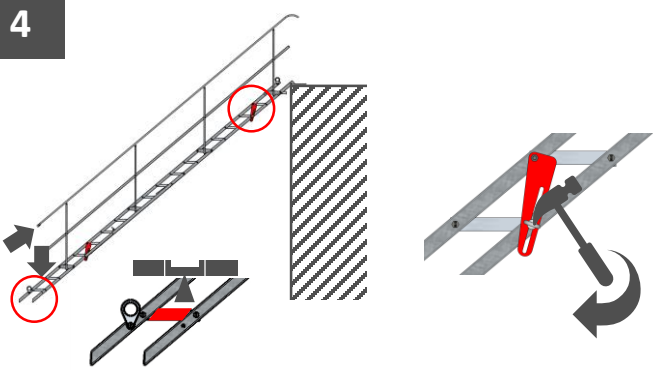

5

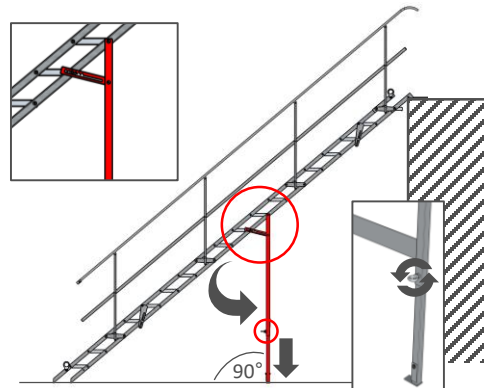

6

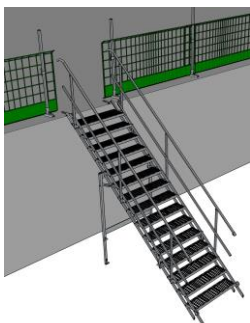

Check every 7 days!



## Stair Connection

1

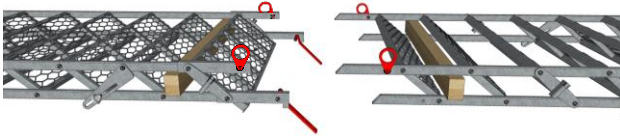

2

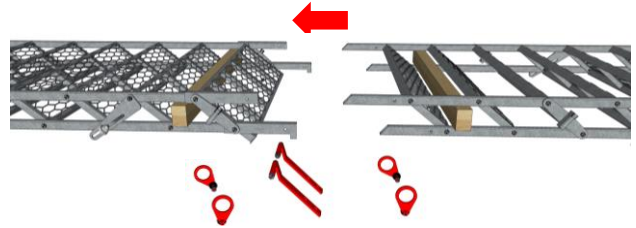

3

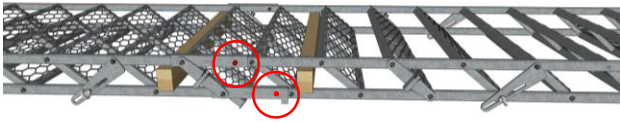

4



- Max. 21 steps (1 support needed)

Height: 3,00 m - 4,70 m

- Max. 2 self-supported stairways connected

Example: Stairway 21 steps (18+3)

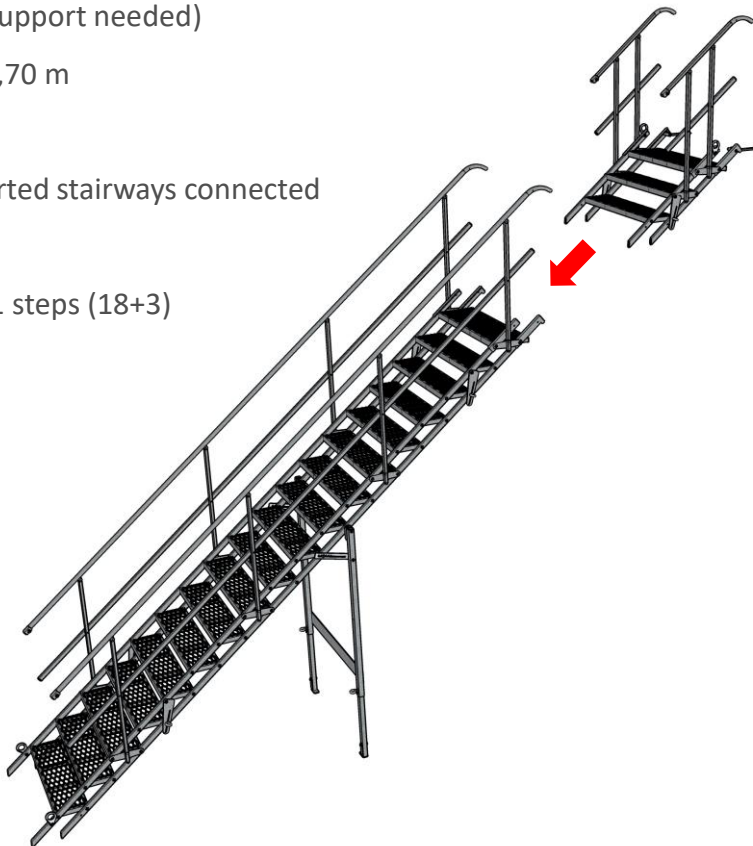

### Inclination Diagram

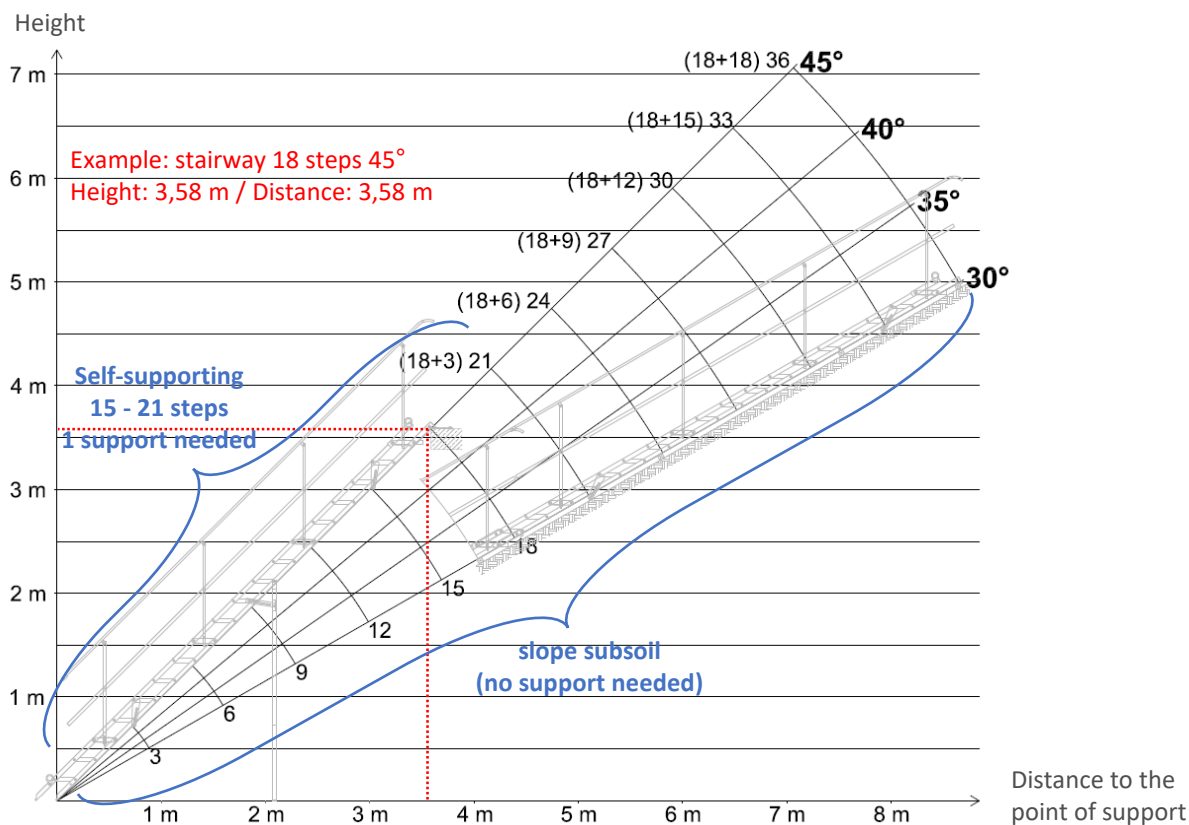

- >21 steps only on an slope subsoil
- >2 stairways connected only on an slope subsoil

Packaging

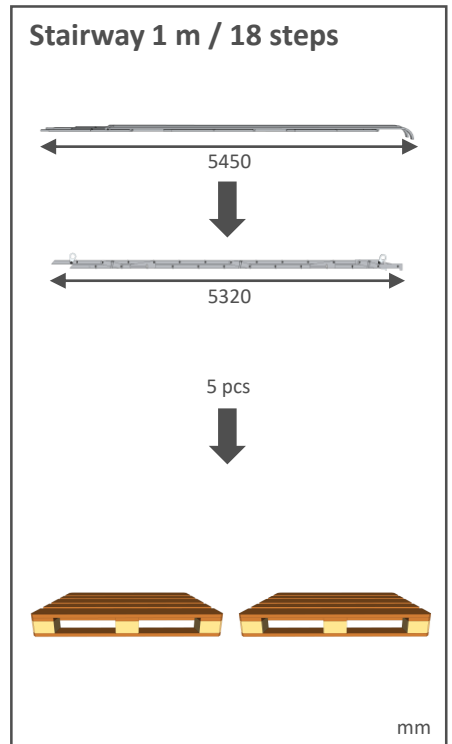
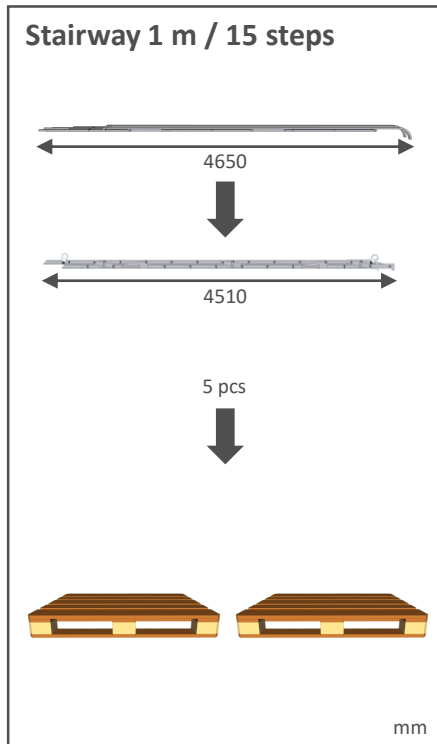
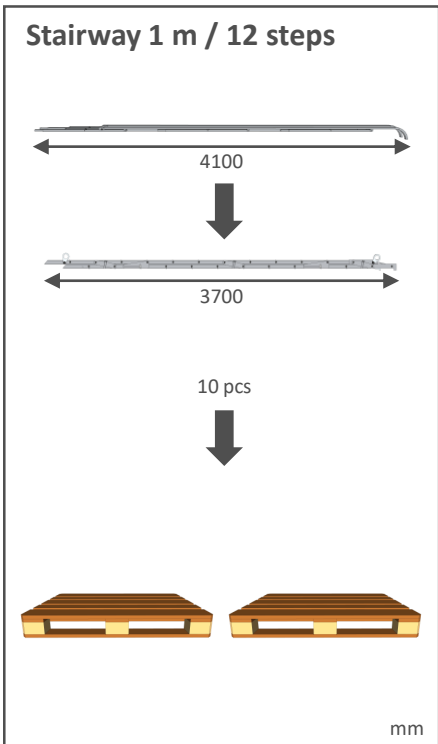
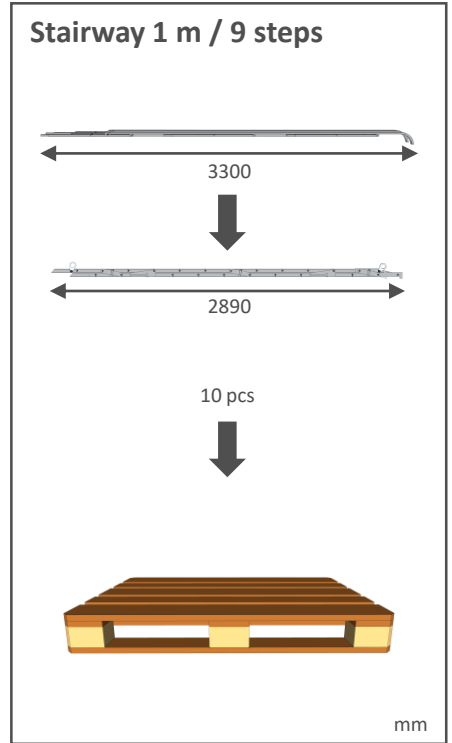
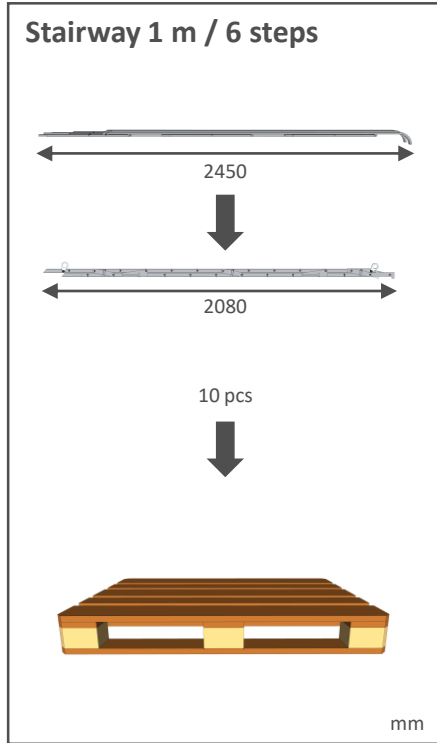
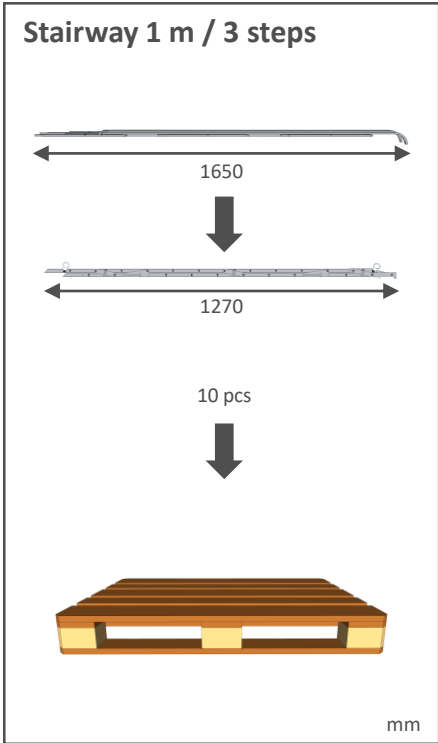

### Components

Example for 15-step Stairway

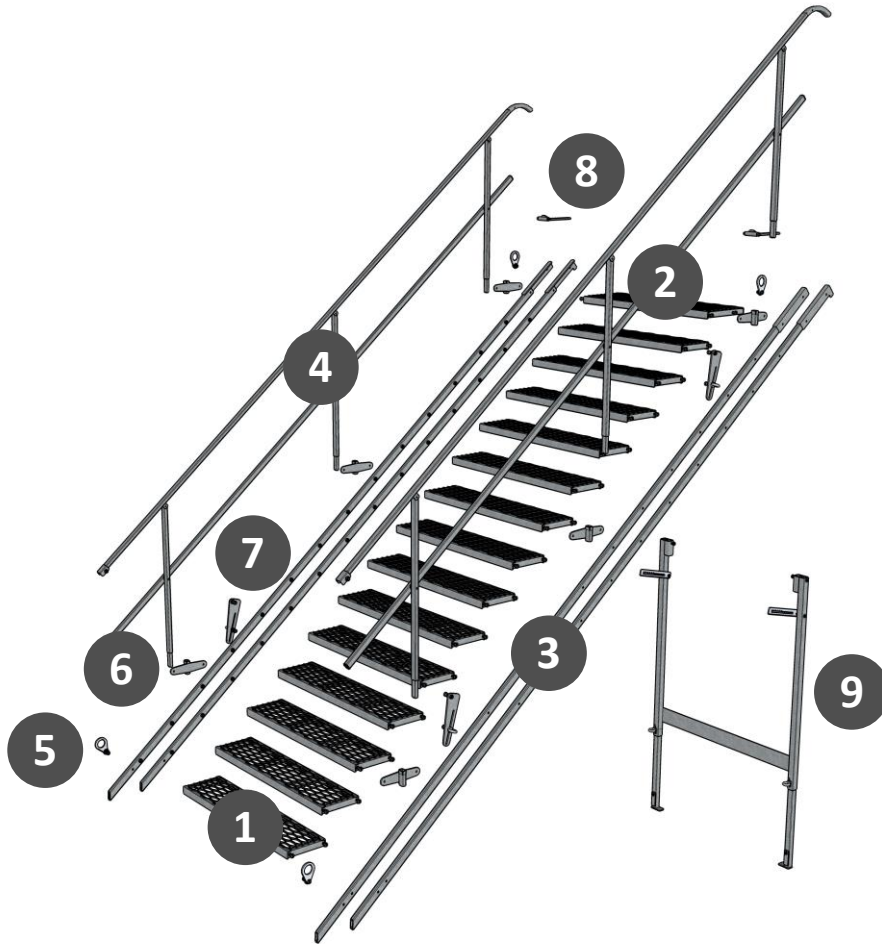

No.	Description	Picture
1	Step 1 m Standard	
2	Step 1 m Big	
3	Side Beam 15 top left	
	Side Beam 15 top right	
	Side Beam 15 bottom left	
	Side Beam 15 bottom right	

No.	Description	Picture
4	Guardrail 15	
5	Crane Hook	
6	Guardrail Holder	
7	Lock	
8	Slabfix	
9	Support 1 m	



BGFIX Danmark ApS  
Sydvestvej 67  
2600 Glostrup

[www.bgfix.dk](http://www.bgfix.dk)  
[order@bgfix.dk](mailto:order@bgfix.dk)

+45 53739540



**|BGFIX®|**