



*Im Prospekt gezeigte Abbildungen
können auf preispflichtige Sonderaus-
stattungen zeigen.*



Inhalt

We are IBAK

Technological leaders since 1945.....	5
Milestones in the company's history.....	6
Product Overview.....	8
Areas of application.....	9

Laterals

Mobile push rod system MiniLite.....	10
--------------------------------------	----

Main sewers

Mobile tractor systems	14
MainLite easy.....	16
MainLite fit.....	20
Vehicle systems	24
Tractor systems with T66 und T76.....	26
PANORAMO 4K, 360°-technology.....	28
Cutting and rehabilitation.....	30

Main sewers and laterals

LISY: Lateral inspection from main sewers.....	36
--	----

Manhole Inspection

PANORAMO SI 4K	40
Inspection system for manholes.....	40

Fast visual check of a sewer

ASPECTA HD	44
Transportable checking system for main sewers.....	44

Leak testing

DPS	48
Leak testing systems.....	48

Technical Data

AxialCam.....	52
NANO/NANO L.....	53
POLARIS.....	54
ORION 3 SD/ORION 3 SD L.....	56
ORION 3/ORION 3 L.....	57
ORPHEUS 2/3.....	58
ORPHEUS 2 HD/3 HD.....	59
ARGUS 5.....	60
ARGUS 6.....	61
CERBERUS.....	62
RETRUS 2/RETRUS 2 HD.....	63
ASPECTA 3.....	64
PANORAMO SI 4K.....	65
PANORAMO 4K / PANORAMO 150 4K.....	66
Camera system/3D-scanner.....	66
LISY.....	67
T66/T76 (HD).....	68
Wheel sets for T66 and PANORAMO 150.....	70
Wheel sets for T76 and PANORAMO.....	71
MicroGator/MicroGator 150.....	72
MicroGator Air.....	73
Overview of cutting robots and equipment carriers.....	74
Cable winches.....	76
KW SI.....	77
KT156.....	78
KW 206/306.....	79
BP2, BP100.....	80
MiniLite.....	81
Software versions	82
for control consoles BP2 and BP100.....	82
Software licences	83
Dongle/device recognition.....	83



Technological leaders since 1945

IBAK Helmut Hunger GmbH & Co. KG is a worldwide operating manufacturer and supplier of sewer inspection and rehabilitation systems. The oldest company in the industry was founded by Helmut Hunger under the name Ingenieur Büro Atlas Kiel in 1945.

At that time, the emphasis was on the repair of electrical equipment; very soon, IBAK began making electro-medical devices themselves. The design and manufacturing department expanded and later encompassed the production of marine searchlights, heaters and underwater CCTV systems.

The first TV system was designed by IBAK engineers for marine research in 1955; for this, commercially available cameras were installed in a watertight case. Thus, there was already some experience available with watertight cameras when shortly later the idea of sewer TV inspection was born. With increasing know-how, the products became smaller and smaller with more functionality until it was eventually possible to operate them even in inaccessible sewers. The first sewer TV system was introduced in 1957. The market quickly recognized the economic benefit of such inspection systems so it was possible to further develop and improve sewer TV technology. The first fully remote-controlled sewer inspection system was launched on the market in 1968; in the 1980s, computer technology, computer-supported evaluation of the inspection data and inspection software were added to the portfolio. In the 1990s, vehicle outfitting played an increasingly important role.

In 2012 the subsidiary IBAK Robotics GmbH was acquired; the extension of the product portfolio to include cutting robots was a consequential step, in order to be able to provide as complete a product range as possible for the sewer inspection and rehabilitation industry.

Even after more than 75 years, IBAK is still the pioneer of innovations in the sewer industry: IBAK demonstrates high solution-finding competence and readiness for innovations with high standards of quality. One in six of IBAK's staff of over 400 is employed in research and development so that we can react quickly to the requirements of the market. The outstanding quality of IBAK products results from a high vertical range of manufacture – IBAK products are manufactured on site in Kiel.

Customers in Germany are looked after promptly at seven locations nation-wide. Experienced staff at our headquarters in Kiel and the IBAK branch offices in Georgsmarienhütte, Moers, Durmersheim, Illerrieden, Freigericht and Leipzig take care of servicing, maintenance and repair of IBAK and IBAK Robotics systems. 40 distributors and service partners worldwide are at the customers' disposal for help and advice.

What began in Kiel is now widely known all over the world. The innovative sewer inspection and rehabilitation systems are in successful operation in more than 40 countries. Whenever local authorities, municipalities and service contractors choose IBAK products, they opt for user-oriented, cost-effective solutions and reliable, durable and forward-looking technology.

Milestones in the company's history

1945: Established by Helmut Hunger as an engineering office; sale of medical devices such as ophthalmic magnets

1957: Introduction of the first sewer TV system

1959: Banknotes forged during World War II salvaged from Lake Toplitz with IBAK underwater searchlights and cameras

1972: Design of a TV and photo carriage for manganese nodule exploration in depths of 6000 m on the research ship Valdivia

1973: Herwig Hunger succeeds his father as managing director. Production of the 679 FM, at that time the biggest searchlight in the world

1980: Delivery of the 200th IBAK inspection vehicle

1982: Construction of the Eastern Scheldt Storm Surge Barrier under observation by an IBAK camera especially designed for the purpose

1987: Presentation of the first sewer analysis software IKAS 10

1991: Dr. Werner Hunger, hitherto senior executive, joins his brother Herwig Hunger in the management

1993: Introduction of the LISY, the world's first lateral inspection system, for entry into laterals from main sewers. IBAK presents the first ARGUS with the patented ROTAX panning mechanism.

1995: The company's 50th anniversary; the IBAK staff now numbers 166

2000: IBAK launches on the market the first camera that can be operated both with a push rod and a camera tractor: the ORION

2002: Invention of PANORAMO technology for the generation of 360° spherical images

2003: Opening of the branch office IBAK-Süd in Senden

2003: Opening of the branch office IBAK-Nordwest in Georgsmarienhütte and IBAK-West in Krefeld

2012: Extension of the product portfolio with electrically driven cutting robots, new subsidiary IBAK Robotics GmbH

2013: Development of the POLARIS push rod camera with which, among other things, 3D-GeoSense pipe run measurements can be performed

2015: On the company's 70th anniversary, the staff of more than 300 are the epitome of innovative products and services

2019: Opening of branch offices in Freigericht and Leipzig. The electric cutting robot for the lateral sector starts practical operation: the NanoGator; IBAK is working on software on the basis of artificial intelligence to reduce the burden on inspectors during condition data capture: ARTIST

2020: Dorian and Daniel Hunger join their father in the management; IBAK makes manhole inspection with 4K resolution possible: the PANORAMO SI 4K; the company's 75th anniversary: IBAK employs a staff of 400 people

2023: Daniel and Dorian Hunger take over as managing directors

Product Overview

Cameras

 AxialCam ≥ DN 50/100 <i>Page 52</i>	 NANO/NANO L ≥ DN 80 <i>Page 53</i>	 RETRUS 2/2 HD ≥ DN 100 <i>Page 63</i>	 POLARIS ≥ DN 100 <i>Page 54</i>	 ORION / ORION 3 ≥ DN 100 <i>Page 56</i>	 ORION L / ORION 3 L ≥ DN 100 <i>Page 57</i>
 ORPHEUS 2 ≥ DN 150 <i>Page 58</i>	 ORPHEUS 3 ≥ DN 150 <i>Page 59</i>	 ARGUS 5 ≥ DN 200 <i>Seite 8</i>	 ARGUS 6 ≥ DN 200 <i>Page 61</i>	 CERBERUS Inspection of main sewers <i>Page 62</i>	 ASPECTA Manhole Zoom Camera <i>Page 64</i>

Camera tractors

 T66/T66 HD ≥ DN 100 <i>Page 68</i>	 T76/T76 HD ≥ DN 100 <i>Page 69</i>	 PANORAMO 150 4K ≥ DN 150 <i>Page 66</i>	 PANORAMO 4K ≥ DN 200 <i>Page 68</i>	 PANORAMO SI 4K ≥ DN 300 Manhole inspection <i>Page 65</i>	 LISY ≥ DN 150 <i>Page 67</i>
--	---	--	--	--	---

Push rod system



MiniLite
≥ DN 50 *Page 81*

Compact systems



MainLite easy
(KT156+BP) *Page 78*







MainLite fit
(KW206/306+BP) *Page 79*

Cable winches

 KW SI Camera cable max. 12m <i>Page 77</i>	 KW 206/306 Camera cable max. 200m/300m <i>Page 79</i>	 KW 305 Camera cable max. 300m <i>Page 76</i>	 KW 305/310 Camera cable max. 600m <i>Page 76</i>	 KW LISY Synchron Camera cable max. 180m <i>Page 76</i>
--	--	---	---	---

Control units and systems

 BP2 <i>Page 80</i>	 BP100 <i>Page 80</i>	 BS3.5/7	 BS5	 BS 10X
---	---	---	---	--

Software





Cutting robots

 MicroGator <i>Page 72</i>	 MicroGator 150 <i>Page 72</i>	 MicroGator Air <i>Page 73</i>	 MicroGator GT <i>Page 73</i>
--	--	--	---

Areas of application

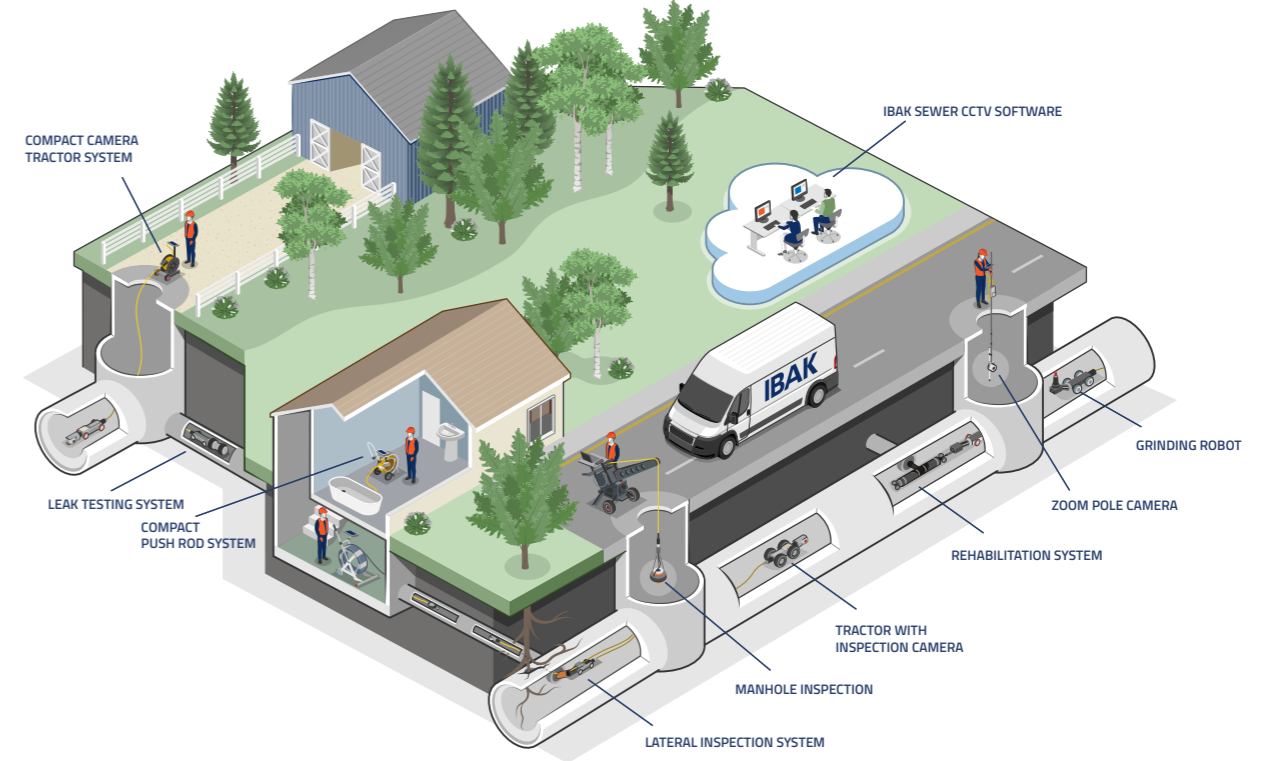

Laterals (DN 50 and up)

Mobile push rod system MiniLite

Laterals – the connection to main sewers

Private buildings are connected to the public sewer system via laterals. Technical progress enables the use of inspection systems in DN 50 and up, even where there is limited accessibility and in ramified pipes.

Depending on the inside diameter and the means of access to the lateral, either a mobile system or a vehicle system with satellite technology is used.



MiniLite 2.1

Push rod system for small and medium diameters

Deployment range DN 50 and up

- **Can be used anywhere:** Typically for operation in laterals – even if they are strongly ramified
- **Added value:** Thanks to extensive measuring functions for qualified condition assessment
- **Versatile use:** Can be adapted to any inspection requirement with different cameras and pushrods
- **More possibilities:** As an ideal addition to an IBAK vehicle inspection system
- **Fast data transfer:** Easy transfer of the inspection results to customers

The IBAK MiniLite is a compact push rod camera system for the inspection of house and estate drainage systems. It covers a broad range of applications thanks to its modular extensibility and extensive accessories. The coiler drum can be exchanged quickly and easily; with the 80 m push rod model, the cameras are plug-in types: compatible are the cameras **ORION**, **NANO** and **POLARIS**, with which diameter measurements can also be performed optionally. According to the requirements, the systems can be additionally equipped with software and an extension kit.

IKAS recorder software is available for simple projects without any complicated data exchange formats. If inspections of sewer systems are to be performed in compliance with the EN 13508-2 standard which is valid in Europe, IKAS mini can be installed and the inspection results output to paper or a pdf file in the form of clearly arranged reports.

If particular data exchange formats are required or if a 3D site plan is to be generated after a 3D-GeoSense pipe run measurement has been performed, the use of complete IKAS evolution software is recommended.

Exchange drums

The MiniLite is standardly supplied with a 500/10 exchange drum with 80 metres of Perfect Push Rod with which a long range can be achieved. Alternatively, exchange drums with the shorter Magic Pushrod which has particularly good bend-passing capabilities are available. If a solution with bend-passing capability is required in particularly small diameter pipes, the 500/12 models with a permanently installed AxialCam and 30 metres of push rod are to be recommended. Push rods are also optionally available with a 512 Hz locator transmitter or can be retrofitted with one.



With camera	AxialCam	NANO	POLARIS	ORION
<i>Technical Data</i>	<i>Page 52</i>	<i>Page 53</i>	<i>Page 54</i>	<i>Page 56</i>
Classification	Axial camera	Pan and tilt camera	Pan and tilt camera	Pan and tilt camera
Deployment range	DN 50 and up	DN 80 and up	DN 100 and up	DN 100 and up
Push operation	✓	✓	✓	✓
Tractor operation	✗	✓	✗	✓
Turning ability	✗	✓	✓	✓
SD	✓	✓	✓	✓
Full HD	✗	✗	✗	✓
Upright picture	✓	✓	✓	✓
Correctly orientated image (ROTAX)	✗	✗	✗	✗
Correctly orientated picture every 180° (e-Flip)	✗	✓	✗	✓
3D-GeoSense	✗	✓	✓	✓
Optical Zoom	✗	✗	✗	2x
Digital Zoom	✗	✗	✗	16x
Joint gap lighting	✗	✗	✗	✗
Ex-protection	✗	✓	✓	✓



More ergonomic and better stability thanks to the revised brake, the improved push rod guide and the changed winding direction!

Main sewers

Mobile tractor systems

Main sewers for wastewater disposal

Functioning sewers are the basis for our modern life. They contribute significantly to health and quality of life and protect the environment. This is why it is essential to determine the complete sewer inventory and to make an optical capture of condition data as a basis for condition assessment and proper professional planning of sewer rehabilitation projects.

Solutions for operation in main sewers include inspection, cleaning and rehabilitation applications. Besides fully equipped vehicle-based systems, IBAK sells several systems for mobile operation which can cover the complete performance spectrum in the field of inspection and rehabilitation.



MainLite easy

Transportable inspection system for main sewers

Deployment range DN 100 and up

- **Can be used anywhere:** Easy to transport even to hard-to-reach places
- **Added value:** Thanks to extensive measuring functions for qualified condition assessment
- **Extends radius of action:** With the portable base for main sewer inspections independently of the vehicle
- **Fast data transfer:** Easy transfer of inspection results to customers

The **MainLite easy** is used when fully-fledged inspections in high quality are to be performed in main sewers, but where the system must also be easily transportable to locations that are difficult to access with a vehicle. The MainLite easy consists of a motor-driven cable winch with 150 metres of camera cable and a control console (BP 100).

Comprehensive software such as IKAS evolution can be installed on the PC of the control console. If, alternatively, only basic software in form of IKAS recorder is required to capture, save and transfer videos and images, this is also possible, as is the installation of IKAS mini. With this model, inspections of wastewater facilities can be performed in compliance with the EN 13508-2 standard that is valid in Europe or WRc. Condition and defects data of sewer reaches and manholes, photos and video recordings can be easily entered and saved thanks to intuitive menu guidance. The inspection results are documented in clearly

arranged reports and saved as a PDF. Data can be transferred to customers via a USB stick or WLAN. Winding on the camera cable of cable winch KT 156 is motor-aided, which is a great handling advantage as opposed to a manual cable winch. Big wheels and a folding transport handle ensure smooth transport and good stability even on uneven ground. The low weight of the KT 156 allows operation by one person and transportation even to locations which are difficult to access.

An integrated counter measures the cable length. The measured value is transferred to the control console and overlaid in the video. To operate the system, only a 230 volt power outlet or a battery pack is required.

The IBAK camera tractors T66 and T76 and the cameras NANO (L), ORION 3 SD (L), ORPHEUS 2/3 and ARGUS 5 can be operated with the MainLite easy.





With camera	NANO	ORION SD	ORPHEUS 2/3	ARGUS 5
<i>Technical Data</i>	<i>Page 53</i>	<i>Page 56</i>	<i>Page 58</i>	<i>Page 60</i>
Classification	Pan and tilt camera	Pan and tilt camera	Pan and tilt camera	Pan, tilt and rotate camera
Deployment range	DN 80 and up	DN 100 and up	DN 150 and up	DN 200 and up
Push operation	✓	✓	✗	✗
Tractor operation	✓	✓	✓	✓
Turning ability	✓	✓	✗	✗
SD	✓	✓	✓	✓
Full HD	✗	✗	✗	✗
Upright picture	✓	✓	✓	✓
Correctly orientated image (ROTAX)	✗	✗	✗	✓
Correctly orientated image every 180° (e-Flip)	✓	✓	✓	✗
3D-GeoSense	✓	✓	✓	✓
Optical Zoom	✗	2x	10x	10x
Digital Zoom	✗	16x	16x	16x
Joint gap lighting	✗	✗	✓	✓
Ex-protection	✓	✓	✓	✓



With tractor	T66	T76
<i>Technical Data</i>	<i>Page 68</i>	<i>Page 68</i>
Deployment range	DN 100 and up	DN 150 and up
Steering function	✓	✓
Cruise control	✓	✓
Wheel quick-change system	✗	✓
Speed	continuously variable	continuously variable
Pressure monitoring	✓	✓
Tilt measurement	✓	✓
Temperature measurement	✓	✓
Ex-protection	✓	✓

MainLite fit

Transportable inspection system for main sewers

Deployment range DN 100 and up

- **Added value:** Thanks to extensive measuring functions for qualified condition assessment
- **Safe investment:** Flexible and future-proof thanks to modular system design
- **Variable use:** In a vehicle and as a mobile inspection system
- **Turnkey solution:** Hardware and software from a single source
- **Fast data transfer:** Easy transfer of inspection results to customers

The system can be operated with several camera/camera tractor combinations for different pipe diameters and applications. For example, a T66 can be operated with the ORION camera in small diameter pipes of DN 100 and up or a T76 camera tractor with an ORPHEUS camera in bigger diameters of DN 150 and up. The MainLite fit consists of the versatile control console BP100 with a 10-inch touch display and two joysticks to operate the camera and the camera tractor. With the mobile rack, the motor-driven winches with 200 metres (KW206) or 300 metres of camera cable (KW 306) can be transported to locations which are hard to access with a vehicle. With the integrated seat, it is also possible to work comfortably outside of the inspection van.





With camera	NANO	ORION SD	ORPHEUS 2/3	ARGUS 5
<i>Technical Data</i>	<i>Page 53</i>	<i>Page 56</i>	<i>Page 58</i>	<i>Page 60</i>
Classification	Pan and tilt camera	Pan and tilt camera	Pan and tilt camera	Pan, tilt and rotate camera
Deployment range	DN 80 and up	DN 100 and up	DN 150 and up	DN 200 and up
Push operation	✓	✓	✗	✗
Tractor operation	✓	✓	✓	✓
Turning ability	✓	✓	✗	✗
SD	✓	✓	✓	✓
Full HD	✗	✗	✗	✗
Upright picture control	✓	✓	✓	✓
Correctly oriented image (ROTAX)	✗	✗	✗	✓
Correctly oriented image every 180° (e-Flip)	✓	✓	✓	✗
3D-GeoSense	✓	✓	✓	✓
Optical Zoom	✗	2x	10x	10x
Digital Zoom	✗	16x	16x	16x
Joint gap lighting	✗	✗	✓	✓
Ex-protection	✓	✓	✓	✓



With tractor	T66	T76
<i>Technical Data</i>	<i>Page 68</i>	<i>Page 68</i>
Deployment range	DN 100 and up	DN 150 and up
Steering function	✓	✓
Cruise control	✓	✓
Wheel quick-change system	✗	✓
Speed	continuously variable	continuously variable
Pressure monitoring	✓	✓
Tilt measurement	✓	✓
Temperature measurement	✓	✓
Ex-protection	✓	✓

Technica Data	MG Air	MG GT Lite
<i>Page 73</i>	<i>Page 73</i>	<i>Page 73</i>
Deployment range	DN 200 and up (relined)	DN 200 and up (system-dependent)
Maximum working range	up to 300 m	system-dependent
Cutting motor drive	pneumatic	✗
Pressure monitoring	✓	✓
Speed	continuously variable	continuously variable
Monitoring camera	✓	✓
Front camera	✗	✗
Rear-view camera	✓	✓
Camera lens cleaning	✓	✓
Inspection	✓	✓
Ultra-high pressure water jet cutting	✗	✓
Top hat installation	✓	✗
Sleeve installation	✓	✗
Lateral connection repair with mortar	✗	✓

Main sewer
Vehicle systems



Vehicle Systems

Tractor systems with T66 und T76

Deployment range DN 100 and up

- **Professional inspection:** The powerful vehicle system for all requirements
- **Added value:** Thanks to extensive measuring functions for qualified condition assessment
- **Secure investment:** Flexible and future-proof thanks to modular system design
- **Turnkey solution:** Hardware and software from a single source
- **Fast data transfer:** Easy transfer of inspection results to the customer

The IBAK camera tractors T66 and T76 form the basis for all inspection requirements in DN 100 and up. All accessories fulfil IBAK's high quality standards and therefore comply with the high requirements for flexibility, short setup times and efficiency.



Tractor	T66	T76
<i>Technical Data</i>	<i>Page 68</i>	<i>Page 68</i>
Deployment range	DN 100 and up	DN 150 and up
Steering function	✓	✓
Cruise control	✓	✓
Wheel quick-change system	✗	✓
Speed	continuously variable	continuously variable
Pressure monitoring	✓	✓
Tilt measurement	✓ (optional, retrofittable)	✓ (optional, retrofittable)
Temperature measurement	✓	✓
Ex-protection	✓	✓



With camera	ORION SD	ORION 3	ORPHEUS 2/3	ORPHEUS 2/3 HD	ARGUS 5	ARGUS 6 (HD)
<i>Techn. Data</i>	<i>Page 56</i>	<i>Page 57</i>	<i>Page 58</i>	<i>Page 59</i>	<i>Page 60</i>	<i>Page 61</i>
Classification	Pan and tilt camera	Pan and tilt camera	Pan and tilt camera	Pan and tilt camera	Pan, tilt and rotate camera	Pan, tilt and rotate camera
Deployment range	DN 80 and up	DN 100 and up	DN 150 and up	DN 150 and up	DN 200 and up	DN 200 and up
Push operation	✓	✓	✗	✗	✗	✗
Tractor operation	✓	✓	✓	✓	✓	✓
Turning ability	✓	✓	✗	✗	✗	✗
SD	✓	✓	✓	✗	✓	✗
Full HD	✗	✓	✗	✓	✗	✓
Upright picture	✓	✓	✓	✓	✓	✓
Correctly orientated image (ROTAX)	✗	✗	✗	✗	✓	✓
Correctly orientated image every 180° (e-Flip)	✓	✓	✓	✓	✗	✗
3D-GeoSense	✓	✓	✓	✓	✓	✓
Optical Zoom	2x	2x	10x	10x	10x	10x
Digital Zoom	16x	16x	16x	16x	16x	16x
Joint gap lighting	✗	✗	✓	✓	✓	✓
Ex-protection	✓	✓	✓ (Version 3)	✓ (Version 3)	✓	✓



Vehicle-bound systems

PANORAMO 4K, 360°-technology

Deployment range DN 150 and up

- **Productive inspection:** Thanks to fast capture of the entire pipe interior view
- **Objective basis for decision-making:** Thanks to the unique 360° all-round view inside the pipe
- **Complete documentation:** Precise data capture including measurements serves as a basis for qualified condition assessment
- **Optimal use of resources:** Evaluation can be carried out directly on site or in the office and supported by artificial intelligence (AI)
- **Safe investment:** Flexible and future-proof thanks to modular system design
- **Fast data transfer:** Easy transfer of inspection results to customers

The IBAK vehicle system with **PANORAMO 4K** supplies ultra-high resolution 3D interior views from main sewers. Instead of video recordings, hemispherical photos are taken with the two high-resolution 4k digital cameras equipped with 185°-fisheye lenses and mounted at the front and rear of the camera tractor. These photos are then put together to form 360°-spherical images. In this way, a real 3D interior view of the complete pipe is generated, and the inspected section can be seen from all angles of view. Evaluation of the condition can be performed separately from the scan at the work station in the office, which increases the productivity.

The data quality and integrity of the inspection data provide an optimum basis for processing and analysis by the ArtIST software which is based on artificial intelligence, because the PANORAMO 4K systems make a complete scan of the interior of pipes entirely in 4K resolution. PANORAMO ArtIST (Artificial Intelligence Software Tool) recognizes defects, laterals etc. automatically and helps users to identify and document defects automatically to the greatest possible extent.

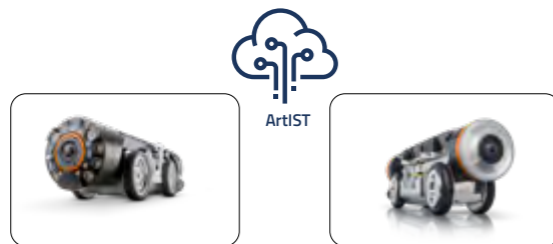

360 degree camera	PANORAMO 150 4K	PANORAMO 4K
<i>Technical Data</i>	<i>Page 66</i>	<i>Page 66</i>
Classification	360 degree camera	360 degree cameras
Deployment range	Sewer inspection	Sewer inspection
Inspection range	DN 150 and up	DN 200 and up
4K	✓	✓
Steering function	✓	✓
Wheel quick-change system	✗	✓
Pressure monitoring	✓	✓
Tilt measurement	✓	✓
Ex-protection	✓	✓



Vehicle-bound systems

Cutting and rehabilitation

Deployment range DN 150 and up

IBAK MicroGator vehicle system for electric or pneumatic cutting and rehabilitation tasks in main sewers

- **Effective cutting:** Through precise control of the cutting process
- **Reliable in operation:** Electrically-driven with low noise or pneumatic operation
- **Safe investment:** Flexible and future-proof thanks to modular system design
- **Added value:** Installation of top hats and sleeves, Lateral connection repair with mortar, ultra-high pressure cutting and inspection
- **Ready for immediate use:** Turnkey solution



Cutting robot	MicroGator 150	MicroGator	MicroGator Air	MicroGator GT	MicroGator GT Lite
Technical Data	Page 72	Page 72	Page 73	Page 73	Page 73
Deployment range	DN 150 and up (relined)	DN 200 and up (relined)	DN 200 and up (relined)	system-dependent	system-dependent
Maximum working range	up to 150 m	up to 150 m	up to 300 m	system-dependent	system-dependent
Cutting motor drive	electric	electric	pneumatic	–	–
Pressure monitoring	✓	✓	✓	✓	✓
Speed	continuously variable	continuously variable	continuously variable	continuously variable	continuously variable
Monitoring camera	✓	✓	✓	✓	✓
Front camera	✗	✓	✗	✗	✗
Rear-view camera	✓	✓	✓	✓	✓
Camera lens cleaning	✓	✓	✓	✓	✓
Inspection	✓	✓	✓	✗	✓
Ultra-high pressure water jet cutting	✗	✗	✗	✓	✓
Top hat installation	✓	✓	✓	✗	✗
Sleeve installation	✓	✓	✓	✗	✗
Lateral connection repair with mortar	✗	✓	✓	✓	✓



Vehicle-bound systems

Cutting and rehabilitation: adapters/accessories

Deployment range DN 150 and up



Top hat installation packer adapter

With the adapter, packers made by Schwalm can be mounted on the MicroGator and introduced into sewers. With these packers, resin-soaked short liners to seal cracks or top hat profiles for lateral connection repair can be positioned at the location to be repaired. The integrated camera makes it easier to position the packer accurately at the defective location in the sewer or at the lateral to be rehabilitated.



Cuff installation packer adapter

With the attachable adapter, packers for the installation of relining cuffs (e.g. Quicklock) can be introduced into sewers with the MicroGator. The cuff system seals and stabilizes the defect mechanically – without using any chemicals and irrespectively of the pipe material. Thanks to observation with the CutterCam, the packer can be positioned with the cuff at the exact location to be sealed. The system's long cable length and good traction of the MicroGator make it possible to push the packer a long way into the sewer, exact alignment is ensured by the movement axes of the MicroGator. Sleeves are available for main sewers with diameters of up to DN800.

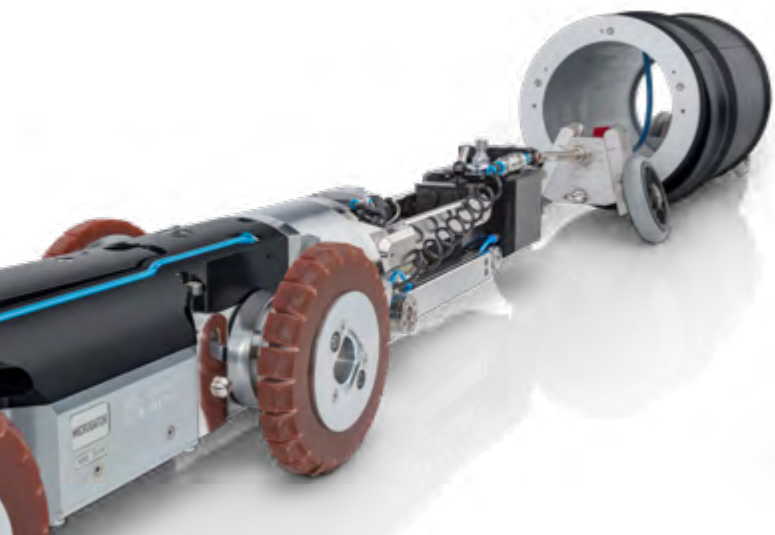

ORION inspection camera adapter

The inspection camera adapter for the MicroGator enables not only a fully-fledged inspection of the sewer where cutting is to be performed before rehabilitation but also an acceptance test inspection after completion of rehabilitation requiring only a minimum of extra time.

FrontCam

The FrontCam is an axial camera that can be mounted in front of the MicroGator motor BG1. The camera makes it easier e.g. to locate laterals that have to be reopened after lining. As the FrontCam is positioned at the front of the cutter and has power LED lighting, the sewer is optimally illuminated without any obstruction to the view from the shadow of the cutting tool.



Cuttercam

The CutterCam ensures a focussed image from the cutting area and also displays e.g. a nearer pipe wall in high picture quality. In this way, the repair results can be evaluated and documented in the software on the basis of the convincing picture material. A permanent airflow forms a sort of shield in front of the lens of the CutterCam and reliably removes the cutting dust. Bigger particles can be flushed away at any time at the push of a button by an additional water nozzle; in the case of extreme soiling, it is possible to eliminate this completely by panning the camera over a rubber lip.

Ultra-high pressure water jet cutter adapter

Extensive persistent deposits in sewers can be removed efficiently and in a controlled manner with an ultra-high pressure water jet. A MicroGator equipment carrier (GT) on which a pivot-mounted cleaning nozzle (made by e.g. falch or Hammelmann) can be operated for this purpose. The GT consists of the tractor, the control equipment and the CutterCam of the electric cutting system. A mobile tool mount that enables the tool to be tilted, panned and inclined is installed instead of the mount for the cutter motor and the motor housing. For example, solid sintering over long sewer reaches can be removed in a very short time under camera observation at a continuously adjustable water pressure of 600 to 2500 bar.



Ovoid Pipe Devices

- for tractors T76 / T 86, MicroGator

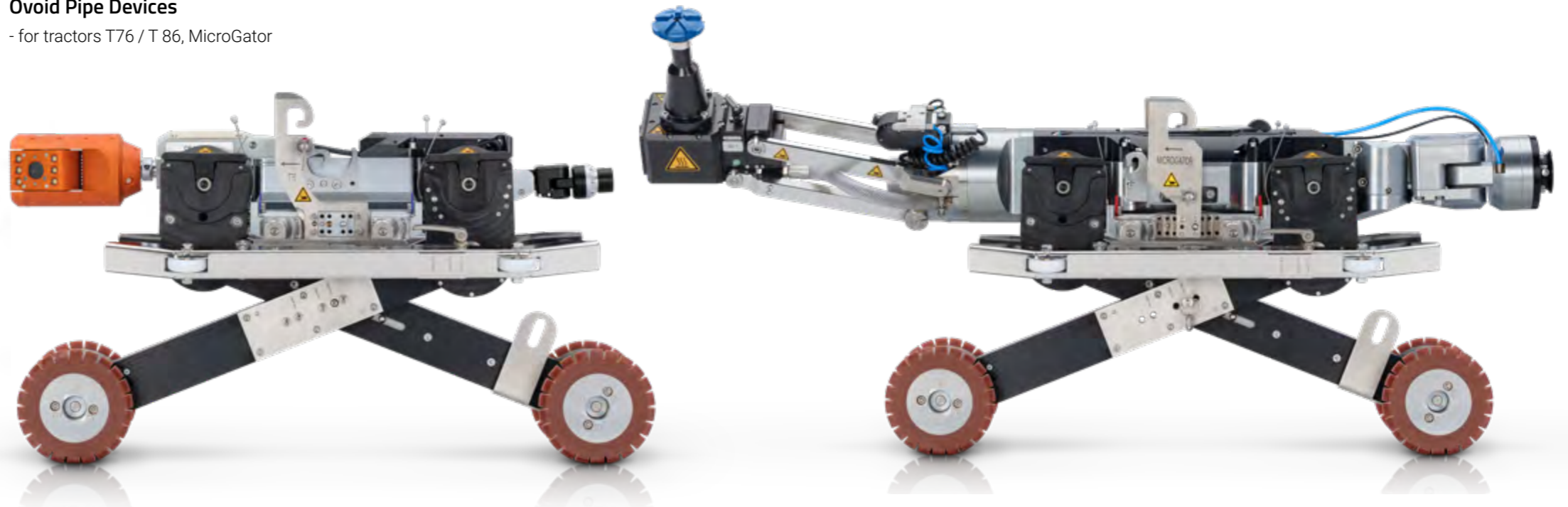

Main sewers and laterals
Lateral inspection from main sewers



Vehicle-bound systems

LISY: Lateral inspection from main sewers

Deployment range DN 150 and up in main sewers,
Lateral diameters of DN 80 and up

The lateral inspection system LISY can be operated in main sewers of DN 150 and up and from there permits the inspection of laterals from DN 80 upwards. A folding joint allows easy entry into sewers, even where there is a bend in the invert; the system can be adapted to the pipe diameter with the electric height adjusting device (LISY lift).

A PHOBOS flushing nozzle can be mounted to propel the camera by means of water and to achieve a certain cleaning effect.

With the LISY system, it is also possible to perform pipe run and position measurements during the inspection. In particular in the case of complex and ramified laterals, precise information on the actual pipe run and position is an important prerequisite for maintenance, exact localisation of defects and for planning further measures.

3D Geosense

Pipe run measurements are automatically recorded and the xyz-coordinates determined in a single operation during the inspection via a 3D sensor integrated into the camera.

Hydrostatic height measurement

With an additional hydrostatic height measurement, the elevation can be determined accurately to a centimetre and the z-axis data can be verified.



With camera	NANO	POLARIS	ORION SD	ORION 3
<i>Technical Data</i>	<i>Page 53</i>	<i>Page 54</i>	<i>Page 56</i>	<i>Page 57</i>
Classification	Pan and tilt camera	Pan and tilt camera	Pan and tilt camera	Pan and tilt camera
Deployment range	DN 80 and up	DN 100 and up	DN 100 and up	DN 100 and up
Push operation	✓	✓	✓	✓
Tractor operation	✓	✗	✓	✓
Turning ability	✓	✓	✓	✓
SD	✓	✓	✓	✓
Full HD	✗	✗	✗	✓
Upright picture	✓	✓	✓	✓
Correctly orientated image (ROTAX)	✗	✗	✗	✗
Correctly orientated image every 180° (e-Flip)	✓	✗	✓	✓
3D-GeoSense	✓	✓	✓	✓
Optical Zoom	✗	✗	2x	2x
Digital Zoom	✗	✗	16x	16x
Joint gap lighting	✗	✗	✗	✗
Ex-protection	✓	✓	✓	✓



Manhole inspection



Manholes as central structures of sewer systems

Manholes provide access to the associated main sewers. In practice, state-of-the-art camera technology is used for manhole inspection, condition capture and documentation. Damage can thus be detected and repaired at an early stage.

PANORAMO SI 4K

Inspection system for manholes

Deployment range DN 300 and up

- **Productive inspection:**
Thanks to fast capture of the entire manhole interior view
- **Objective basis for decision-making:**
Thanks to the unique 360°-all-round view inside the manhole
- **Complete documentation:**
Precise data capture including measurements serves as a basis for qualified condition assessment
- **Variable use:** In a vehicle and as a mobile inspection system
- **Safe investment:** Flexible and future-proof thanks to modular system design
- **Fast data transfer:** Easy transfer of the inspection results to customers

The PANORAMO SI 4K manhole inspection system delivers ultra-high resolution 3D manhole images and precise measured data.

The system can be used both from a vehicle or in mobile operation; it can be converted in a few steps so that it is possible to react flexibly to the local conditions and also to reach manholes that are difficult to access.

	PANORAMO SI 4K
Classification	360 degree camera
Range of application	manhole inspection
Deployment range	ab DN 300
4K	✓
Speed control	✓
Pressure monitoring	✓
Ex-protection	✓



Checking the operational status of a sewer



Quick assessment of the condition of the sewer system

The IBAK Zoom pole camera system allows the user to carry out an immediate visual inspection using very little time and equipment. It can be used to quickly inspect and assess the condition of wastewater pipes from adjacent manholes.

ASPECTA HD

Transportable checking system for main sewers

Deployment range DN 150 and up

The ASPECTA HD enables quick condition detection and evaluation of sewers from adjacent manholes

- **Immediate visual inspection:** For a quick first impression in Full HD resolution without much time and equipment requirement
- **Time-saving tool:** For efficient and targeted use of existing inspection resources
- **Helpful basis:** For prioritising inspection, cleaning and rehabilitation measures
- **Revealing insights:** For more certainty in the evaluation of structures that are difficult to access
- **Versatile use:** In addition to sewers, tanks, pits, boilers and many other vessels can also be inspected



Vehicle system for main sewer and lateral inspection with leak testing unit



IBAK Modular sewer leak testing system

TV inspection remains the indispensable basis for any rehabilitation decisions that may be necessary. However, as leaks also often have causes not visible to the eye, the watertightness of sewers cannot always be reliably ascertained by a TV system. The IBAK DPS leak testing system is designed for operation in pipes of DN 100 upwards with circular cross-sections. Depending on the model, positive air tests, negative air tests and water tests are possible. With the IBAK DPS components, a flexible system is available that covers the entire application range of leak tests: sewer reaches, joints, pipe sockets, ground pipes and laterals can be tested for leaks. The IBAK leak test components can be integrated into IBAK sewer TV systems. A combined control unit and a cable winch (KW 505) with 250 metres of combined camera and compressed air cable (hybrid cable) ensure a clear arrangement of devices. All components are easy to handle and have short setup times; they are designed for one-person operation and efficient working procedures.

DPS

Leak testing systems

Deployment range DN 100 and up

Vehicle system for main sewer and lateral inspection with leak testing unit

The IBAK vehicle system for main sewer and lateral inspection provides inspection data from main sewers, laterals and manholes as well as information on leak tightness.

- **Effective combination:** Inspection and leak test to standards with a single vehicle system e.g. for new construction acceptance
- **Added value:** Thanks to extensive measuring functions for qualified condition assessment
- **Safe investment:** Flexible and future-proof thanks to modular system design
- **Turnkey solution:** Hardware and software from a single source
- **Fast data transfer:** Easy transfer of inspection results to customers

Testing of lateral connections and laterals from main sewers

With the IBAK LISY inspection system, a special-test packer with an integrated satellite pipe plug is pushed through the main sewer (DN 200 and up) as far as the lateral (DN 100 and up). The DPS LISY system enables the pipe plug to be pushed a further 40 metres into the lateral with the LISY push rod type Magic Push Rod.

The full range of the system is 130 metres. As soon as the pipe plug is positioned at the desired location, the sealing cuffs of the test packer and the pipe plug are inflated. The sealed-off test area is then filled with compressed air via the hybrid cable of the IBAK cable winch KW 505 – a camera cable with an integrated compressed air line. The pressure data is measured and further processed by the PC, in addition, the data can be overlaid in the video picture. There is no interruption to the flow during the leak test so that the sewer does not have to be taken out of service.



Test of sewer sections with air

The section to be inspected is sealed off with two pipe plugs on each end of the main pipe section. Either positive or negative air pressure (depending on the desired test method) is generated in the test area with a pressure vacuum pump.

A pressure sensor measures the pressure and reports this to the connected PC. The pressure curve is displayed graphically on the PC monitor, the measured data is saved and can be viewed and printed out at any time as a test report. If the values for the permitted pressure drop are not met, the pipe has failed the pressure test and is identified as leaking. This can be clearly seen from the report that is created with IBAK's own IDAS software, just like all other required data.

Test of sewer sections with water

The purpose of testing sewer sections with water is to confirm the watertightness of the drainage structure. If it has failed an air test, a water test can then be performed. If the defined threshold values are not exceeded during the test, the pipe is identified as watertight - even if the previous air test was negative. As with the leak test with air, the reach is first sealed off; the test area is filled with water, e.g. from the tank of a flushing vehicle.

The pipe test plug contains a pressure sensor that registers the water pressure. This should be kept constant during the duration of the test. The water that escapes from the test area is replaced via the gravity tank and the water meter, at the same time, the replenished water volume is registered in the IDAS software and indicated in the test report. Here this also applies: if the leaking volume of water does not exceed a defined threshold value within the specified test duration, the reach is identified as watertight in compliance with DIN EN 1610 and DWA-A139.





AxialCam

Axial camera

Deployment range DN 50 and up



- Very small dimensions
- Inspection of pipes as small as DN 50 and up
- Great bend-passing capability
- Always erect image

The AxialCam mounted on the push rod camera system MiniLite is the ideal camera for the inspection of ramified laterals with small diameters. It is suitable for the deployment range of DN 50 and up and is permanently installed on the push rod. With its small diameter of 39 mm and its optimized bend-passing capability, it is the ideal camera for the inspection of ramified lateral networks. The integrated adjustable LED lighting provides optimum illumination of the inspection area and even this small axial camera always supplies an erect image.

Technical System Data AxialCam	
Classification	Axial camera
Deployment range	DN 50 and up
Dimensions	Ø 39 mm / length 47 mm
Weight	180g
Push operation	✓
Tractor operation	✗
Upright picture (UPC)	✓
Correctly oriented image	✗
Zoom	✗
F (shutter)	1 : 2.2
f (focal length) (mm)	2.5
Lighting	6 Highpower LEDs
Light sensitivity (lux)	0.025 lux
Protection class	IP 68
Permissible ambient temperature	C - +40°C during operation
Pressure monitoring	✗
Aperture function	fixed shutter
Panning range	axial view
Angle of rotation	-
Focus	5 cm – 20 cm, fixed
Sensor	1/4" CMOS
TV Standard	NTSC or PAL
Horizontal picture resolution	420 TVL
Integrated laser	✗
Integrated locator transmitter	✗
Ex-protection	✗
3D-GeoSense	✗
Combinable with	
IBAK push system	MiniLite
IBAK control system	BP 2, BP 100

NANO/NANO L

Pan and tilt camera

Deployment range DN 80 and up



- Great bend-passing capability
- Automatic return to zero position
- Optional 3D-Geosense sensor
- Flexibly deployable with push rod systems or camera tractors
- Optional ex-protection

The **IBAK NANO / NANO L** camera is the smallest pan and tilt camera in the IBAK portfolio. It can be operated in pipes with diameters as small as DN 80 and up and is available with or without a Kiel rod guide unit. Desired viewing directions accessed under micro-processor control by the pan and tilt head which can also rotate endlessly around its own axis. The pan function permits a view in all directions, automatic panning around pipe joints and a view to the rear into branch pipes. Three preselectable focus memory points make the process of panning around joints even easier to handle and enable the user to reach the target position rapidly as frequent refocussing is unnecessary. The NANO generates an erect image in axial viewing direction by means of the UPC function (Upright Picture Control).

With its slim diameter of 47 mm, the camera can be operated with all current IBAK push rod systems, camera tractors and the IBAK LISY satellite system and has full bend-passing capability (can change direction in up to DN 150 pipes). In addition, thanks to the optional sensor system, it can be used with 3D-GeoSense systems to create 3D pipe network plans.

The spectrum of applications of IBAK systems can be extended with the IBAK NANO / NANO L – it is in its element in particular in relined and/or ramified DN 100 lateral networks. The industrial sector, where long, ramified, hard-to-access lateral networks are often encountered, is also an ideal field of application for the NANO and the NANO L.

Technical System Data NANO	
Classification	Pan and tilt camera
Deployment range	DN 80 and up
Dimensions	Ø 47mm / length 83 mm
Weight	approx. 0.320 kg
Push operation	✓
Tractor operation	✓
Upright picture (UPC)	✓
Correctly oriented image	✓
Zoom	✗
F (shutter)	1 : 2.0
f (focal length) (mm)	3.8
Lighting	4 white power LEDs
Light sensitivity (lux)	0.025 lux
Protection class	IP 68
Permissible ambient temperature	C - +40°C during operation
Pressure monitoring	2 integrated pressure sensors
Aperture function	fixed shutter
Panning range	+/-120°
Angle of rotation	endless
Focus	manually 1 cm – ∞, remote-controlled in endless operation
Sensor	1/4" CMOS
TV Standard	NTSC or PAL
Horizontal picture resolution	420 TVL
Integrated laser	✓
Integrated locator transmitter	✓
Ex-protection	✓ (optional)
3D GeoSense	✓ (optional)
Combinable with	
IBAK tractors	all models
IBAK push system	MiniLite
IBAK satellite system	LISY
IBAK control systems	BS 3.5, BS 5, BS 7, BS 10 X, BP 2, BP 100

POLARIS

Pan and tilt camera

Deployment range DN 100 and up



The pushrod camera **IBAK POLARIS** has bend-passing capability, 90° direction changing ability, a 100% field of view and it can be used in pipes of DN 100 and up. As the camera is positioned right at the front, no guide device appears in the image during operation. In addition, the camera can pan at an angle of 90° to the pipe wall to ensure optimum inspections. The POLARIS can also pan automatically around joints (360°). Three preselectable focus memory points make the process of panning around joints even easier to handle and enable the user to reach the target position rapidly as frequent refocussing is unnecessary.

- 90° bend-passing capability in DN 100 and up
- 360°-panning around joints
- 100% free field of view
- Optional 3D-Geosense sensor
- Optional ex-protection

Technical System Data POLARIS

Classification	Pan and tilt camera
Deployment range	DN 100 and up
Dimensions	Ø 60 mm / length 285 mm (direction-changing ability)
Weight	approx. 0.8 kg
Push operation	✓
Tractor operation	✗
Upright picture (UPC)	✓
Correctly oriented image	✗
Zoom	✗
F (shutter)	1:2.0
f (focal length) (mm)	3.8
Lighting	4 white power LEDs
Light sensitivity (lux)	0.025 lux
Protection class	IP 68
Permissible ambient temperature	0° C bis + 40° C
Pressure monitoring	2 integrated pressure sensors
Aperture function	fixed shutter
Pan range	+ / -120°
Angle of rotation	endless
Focus	manually 1 cm – ∞, remote-controlled in endless operation
Sensor	1/4" CMOS
TV Standard	NTSC or PAL
Horizontal picture resolution	420 TVL
Field of view	+ / -150°
Integrated laser	✓
Integrated locator transmitter	✓
Ex-protection	✓ (optional)
3D GeoSense	✓ (optional)

Combinable with

IBAK push system	MiniLite
IBAK satellite system	LISY
IBAK control systems	BS 3.5, BS 5, BS 7, BS 10 X, BP 2, BP 100



ORION 3 SD/ORION 3 SD L

Pan and rotate camera

Deployment range DN 100 and up



The **IBAK ORION** (version 3 SD) can be operated not only with all push rod systems but also with all camera tractors and is therefore the most versatile IBAK camera. Any desired viewing direction is reached without delay with the pan and rotate head under micro-processor control; in addition, the camera head can rotate endlessly around its own axis. The pan function permits a view in all directions, automatic panning around joints and a view to the rear into laterals. In axial view, the camera always provides an erect image thanks to the UPC function (Upright Picture Control); with its small diameter of 60 mm, the camera can be connected to all IBAK camera tractors and has full bend-passing capability when operated as a push rod camera.

The system is protected by an internal operating pressure of 2 bar and internal pressure monitoring – in case of a pressure drop, the inspector receives a warning message on the LCD display and a warning signal in the control unit. The ORION features a wide angle of aperture, high light sensitivity, a powerful zoom and great depth of focus and makes inspections possible in diameters of up to DN 600 without additional lighting. The 3D version of the ORION can be used for pipe run measurements – depending on the requirements with or without explosion protection. The position of the ORION can be determined at any time with the integrated locator transmitter that can be switched on as required and with the built-in laser, diameter and deformation measurements (in combination with IBAK IKAS software) can be conveniently performed during pipe inspections. The ORION L is used in ramified lateral networks. Its guide unit, the Kiel rod, can be panned and rotated in all directions and guides the camera smoothly into laterals.

Technical System Data ORION 3SD	
Classification	Pan and tilt camera
Deployment range	DN 100 and up
Dimensions	Ø 60 mm / length 100 mm
Weight	500 g
Push operation	✓
Tractor operation	✓
Upright picture (UPC)	✓
Correctly orientated picture	✓ (e-Flip)
Zoom	Digital: 16 x digital, analogue 2x optical loss-free
F (shutter)	1:4.0
f (focal length) (mm)	4
Lighting	12 high power LEDs
Light sensitivity (lux)	0.01 lux
Protection class	IP 68
Permissible ambient temperature	C - +40°C during operation
Pressure monitoring	2 integrated pressure sensors
Aperture function	fixed shutter
Panning range	+/-120°
Angle of rotation	endless
Focus	One-push autofocus, manual focus, ~10 mm-∞
Sensor	1/2.8" CMOS
TV Standard	NTSC or PAL
Horizontal picture resolution	700 TVL
Integrated laser	✓ (optional)
Integrated locator transmitter	✓ (optional)
Ex-protection	✓ (optional)
3D GeoSense	✓ (optional)

Combinable with

IBAK tractors	all current tractors
IBAK push system	MiniLite
IBAK satellite system	LISY
IBAK control systems	all current systems

- 360°-panning around joints
- Optionally with rod for changing direction
- Recall of programmable viewing positions
- High-performance power LED lighting (Can be exchanged at the job site)
- Optionally with 3D-GeoSense
- Deployable with push rod systems or camera tractors
- Optional ex-protection

ORION 3/ORION 3 L

Pan and rotate camera

Deployment range DN 100 and up



Depending on the system configuration, the **IBAK ORION 3** provides a full HD image (1920 x 1080 pixels), an HD image (1280x720) or an SD image (720 x 576 pixels). Thus, it is not only connectable to a full HD system but also as an analogue camera to IBAK push rods and therefore e.g. to the LISY satellite system. When operated on a push rod, it is automatically identified as an analogue camera and the system switches over automatically. In addition, depending on the situation, with a full HD system, the desired resolution can be selected in the user menu. If the ORION 3 is operated as a full HD camera with an inspection system, it transmits uncompressed HDSDI signals via a fibre optic cable and therefore generates video images of highest quality without any time lag between scanning in the pipe and display on the monitor.



Technical System Data ORION 3	
Classification	Pan and tilt camera
Deployment range	DN 100 and up
Dimensions	Ø 60 mm / length 100 mm
Weight	500 g
Push operation	✓
Tractor operation	✓
Upright picture (UPC)	✓
Correctly orientated picture	✓ (e-Flip)
Zoom	Digital: 16 x digital, analogue 2x optical loss-free
F (shutter)	1:4.0
f (focal length) (mm)	4
Lighting	12 high power LEDs
Light sensitivity (lux)	0.01 lux
Protection class	IP 68
Permissible ambient temperature	C - +40°C during operation
Pressure monitoring	2 integrated pressure sensors
Aperture function	fixed shutter
Panning range	+/-120°, 75°-165° / 0°-165° (with rod only)
Angle of rotation	endless
Focus	One-push autofocus, manual focus, ~10 mm-∞
Sensor	1/2.8" CMOS
TV Standard	HD, Full-HD, PAL, NTSC
Horizontal picture resolution	analogue: 700, digital: 1100 TVL
Integrated laser	✓ (optional)
Integrated locator transmitter	✓ (optional)
Ex-protection	✓ (optional)
3D GeoSense	✓ (optional)

Combinable with

IBAK tractors	all models
IBAK push system	MiniLite
IBAK control systems	all models

- 90° bend-passing capability in DN 100 and up
- Can be operated as an SD or full HD camera
- 360°-panning around joints
- Automatic return to zero position
- Optionally with rod for changing direction
- Recall of programmable viewing positions
- High-performance power LED lighting
- Optionally with 3D-GeoSense

ORPHEUS 2/3

Pan and rotate camera

Deployment range DN 150 and up



- 360°-panning around joints
- Automatic return to zero position
- Recall of programmable viewing positions
- Power-LED lighting can be switched on flexibly (temperature- monitored)
- One-push autofocus
- Optional ex-protection (ORPHEUS 3)
- Internal pressure monitoring
- Optionally with 3D-GeoSense
- Optionally with LaserScan profile and deformation measurement

The **IBAK ORPHEUS** is a camera that can be operated with all IBAK tractors in DN 150 and up. Features such as optional explosion protection, locator transmitter or 3D sensors for pipe run measurement and profile measurements over the entire length of a sewer reach.

The IBAK ORPHEUS features high light sensitivity and powerful illumination with 12 power LEDs so that pipes with bigger diameters can be inspected without additional lighting. The power LEDs can be switched on and off flexibly and are equipped with integrated joint gap lighting and an automatic lighting adjustment function which adapts the brightness of the LEDs to the pipe environment. Factors such as the pipe diameter and material affect the amount of light required. The automatic lighting adjustment function always ensures that only as much power as necessary is used and glare is prevented. The camera head can rotate endlessly and automatic panning around joints is possible. In addition, the ORPHEUS is equipped with a 10x optical zoom.

Technical System Data ORPHEUS 2/3

Classification	Pan and tilt camera
Deployment range	DN 150 and up
Dimensions	Ø 110 mm / length 160 mm
Weight	1.6 kg
Push operation	✗
Tractor operation	✓
Upright picture (UPC)	✓
Correctly orientated picture	✓ (e-Flip)
Zoom	10x optical; 12x digital
F (shutter)	1.8 to 1:22
f (focal length) (mm)	3.3 to 33
Lighting	10+2 high power LEDs, (2x for illuminating joint gaps) switchable, controllable, temperature- controlled
Light sensitivity (lux)	0,5 lux
Protection class	IP 68
Permissible ambient temperature	C - +40°C during operation
Pressure monitoring	2 integrated pressure sensors
Aperture function	manual, automatic, remote-controlled
Panning range	+/-120°
Angle of rotation	endless
Focus	manuell 1 cm – ∞ remote-controlled, autofocus
Sensor	1/3" (Full HD 16:9, 4.080.000 px)
TV Standard	NTSC or PAL
Horizontal picture resolution	> 720 Lines PAL
Integrated laser	✓ (2 x, Laser-Scan mode)
Integrated locator transmitter	✓ (optional)
Ex-protection	2: nein 3: ja
3D GeoSense	✓ (optional)

Combinable with

IBAK tractors	all models
IBAK control systems	BS 3.5, BS 5, BS 7, BS 10 X, BP 100



LaserScan measurement and 3D-GeoSense

LaserScan deformation and profile measurements can be performed with all current ORPHEUS models so that an analysis of the pipe profile or deformation over the entire length of a sewer section can be created. Pipes with circular and ovoid cross-sections

are supported. The measurement is performed during the camera's return journey out of the sewer via two laser points aligned at an angle of 90° to the pipe wall. The camera is set in rotation and the complete profile of the section is scanned. This produces a spiral pattern of laser measuring points which are analysed by the software and displayed both in graphical form

ORPHEUS 2 HD/3 HD

Pan and rotate camera

Deployment range DN 150 and up



In addition to the features of the ORPHEUS 2/3, the ORPHEUS HD models are equipped with an image sensor in full HD format (1920 x 1080 = 2.08 million pixels), which has approx. 5 times as many pixels as a conventional PAL sensor. The workflow is digital throughout, from generation of the image in the camera head to display and storage in the control unit (HDSDI technology). The signals are transmitted by fibre optic cables so that there is no time lag between the scan in the pipe and display on the monitor in the operator's section of the van. Camera cables with optical fibres are not susceptible to interference and are extremely hard-wearing. In addition, they can be easily cut off and reconnected if a repair is necessary.

Technical System Data ORPHEUS 2HD/3HD

Classification	Pan and tilt camera
Deployment range	DN 150 and up
Dimensions	Ø 110 mm / length 170 mm
Weight	1.6 kg
Push operation	✗
Tractor operation	✓
Upright picture (UPC)	✓
Correctly orientated picture	✓ (e-Flip)
Zoom	10x optical; 16x digital
F (shutter)	1.8 to 1:22
f (focal length) (mm)	3.3 to 33
Lighting	10+2 high power LEDs, (2x for illuminating joint gaps) switchable, controllable, temperature- controlled
Light sensitivity (lux)	0.5 lux
Protection class	IP 68
Permissible ambient temperature	C - +40°C during operation
Pressure monitoring	2 integrated pressure sensors
Aperture function	manual, automatic, remote-controlled
Panning range	+/-120°
Angle of rotation	endless
Focus	manual 1 cm – ∞ remote-controlled, autofocus
Sensor	1/3" (Full HD 16:9, 4.080.000 px)
TV Standard	FullHD (SDI)
Horizontal picture resolution	800 TVL
Integrated laser	✓ (2 x, Laser-Scan mode)
Integrated locator transmitter	✓ (optional)
Ex-protection	2:no 3: yes
3D GeoSense	✓ (optional)

Combinable with

IBAK tractors	all models
IBAK control systems	BS5, BS 7, BS 10 X

and as a report. If besides the analysis of the pipe profile the position and height coordinates of the sewer network are required, a 3D-GeoSense pipe run measurement can be performed additionally, in order to determine the x,y,z-coordinates. Particularly when it is assumed that the pipe run is not linear, an exact geodetic site measurement can supply relevant data for the planning of rehabilitation measures. With the mentioned measurements, information that goes far beyond the results of purely optical inspections is yielded. The results of the measurements essentially offer an important basis for the selection, calculation and planning of the most suitable rehabilitation methods in terms of technology and cost-effectiveness.



ARGUS 5

Pan, tilt and rotate camera

Deployment range DN 200 and up



The **IBAK ARGUS 5** is a pan, tilt and rotate camera for the inspection of main sewers of DN 200 and up. The ROTAX panning mechanism ensures that the camera image always remains erect and non-reversed when the camera head is panned, tilted or rotated. In addition, the ARGUS 5 can be switched over at the push of a button to suit the particular requirements of each specific job. Pan mode (viewing direction right / left, e.g. for laterals) or tilt mode (viewing direction up / down, e.g. for pipe invert) can be chosen with the preselection key. Other selectable functions '45° viewing direction' (with BS 5) '90° viewing direction' (both in all directions: right / left / up / down), 'zero position' and 'automatic pan around joints' make for convenient and efficient working.

The integrated, adjustable power LEDs ensure the best possible illumination both at short and long range so that even pipes with bigger diameters can be inspected without additional lighting. The left and right light units, which can be switched on and off separately and which are panned together with the camera head make it easier to clearly identify defects and to distinguish them e.g. from filler shadows. In addition, the camera features integrated joint gap lighting which can be switched on as required and an automatic panning function.

Whenever the camera pan head changes position or returns to zero, the automatic autofocus triggers the One-push autofocus function and immediately produces a sharp image.

The integrated laser enables diameter, deformation and defects measurements to be performed.

Technical System Data ARGUS 5	
Classification	Pan, tilt and rotate camera
Deployment range	DN 200 and up
Dimensions	ø 120 mm / length 195 mm
Weight	approx. 3.5 kg
Push operation	X
Tractor operation	✓
Upright picture (UPC)	✓
Correctly orientated picture	✓ (Rotax)
Zoom	10x optical, optionally 4x digital
F (shutter)	1.8 to 2.9
f (focal length) (mm)	4.2 to 42
Lighting	8 white power LEDs, 6 white 5mm LEDs for joint gap lighting
Light sensitivity (lux)	1.5 lux
Protection class	IP 68
Permissible ambient temperature	C - +40°C during operation
Pressure monitoring	2 integrated pressure sensors
Aperture function	manuell, automatisch, fernbedienbar
Panning range	+/-120°
Angle of rotation	endless
Focus	manuell 1 cm – ∞ fernbedienbar, Autofocus
Sensor	1/4" CMOS
TV Standard	NTSC or PAL
Horizontal picture resolution	460 TVL
Integrated laser	✓
Integrated locator transmitter	X
Ex-protection	✓ (optional)
3D GeoSense	X

Combinable with	
IBAK tractors	T66, T76
IBAK push system	-
IBAK control systems	BS 3,5, BS 10 X, BS 5, BS 7, BP 100

- ROTAX mechanism (erect, non-reversed image when the camera head is panned, tilted or rotated)
- One-push autofocus
- Integrated locator transmitter

ARGUS 6

Pan, tilt and rotate camera

Deployment range DN 200 and up



The **IBAK ARGUS 6** features the time-tested functions of the ARGUS 5, but is the first IBAK camera model that combines the well-proven ROTAX panning mechanism with full HD resolution. Besides this, with tractor-operated IBAK HD systems, the speed of the automatic panning function around joints can be adapted to suit the pipe diameter so that an optimum recording quality is always achieved.



Technical System Data ARGUS 6	
Classification	Pan, tilt and rotate camera
Deployment range	DN 200 and up
Dimensions	ø 120 mm / length 209 mm
Weight	approx. 3.8 kg
Push operation	X
Tractor operation	✓
Upright picture (UPC)	✓
Correctly orientated picture	✓ (Rotax)
Zoom	10x optical, 16x digital
F (shutter)	1.8 to 22
f (focal length) (mm)	3,3 bis 33
Lighting	8 white power LEDs, 6 white 5mm LEDs for joint gap lighting
Light sensitivity (lux)	0.5 lux
Protection class	IP 68
Permissible ambient temperature	C - +40°C during operation
Pressure monitoring	2 integrated pressure sensors
Aperture function	manual, automatic, remote-controlled
Panning range	+/-120°
Angle of rotation	endless
Focus	manual, one-push autofocus, 1 cm – ∞, remote-controlled
Sensor	1/3" (Full HD 16:9, 4.080.000 Pixel)
TV Standard	HD, fullHD
Horizontal picture resolution	800TVL
Integrated laser	✓
Integrated locator transmitter	X
Ex-protection	✓ (optional)
3D GeoSense	✓ (optional)

Combinable with	
IBAK tractors	T66, T76
IBAK push system	-
IBAK control systems	BS 5, BS 7, BS 10 X

CERBERUS

Handheld axial camera

Inspection on foot of large-diameter pipes



- Automatic shutter and focus functions
- Autofocus
- 10x optical zoom
- 2 Power LED lights for best possible illumination
- Internal pressure monitoring
- Connectible to vehicle systems
- Laser for easier determination of crack widths
- Voice communication between the inspectors

Technical System Data CERBERUS

Classification	Handheld axial camera
Deployment range	inspection on foot of man-sized sewers
Dimensions	W 290 mm / H 240 mm / D 110 mm
Weight	approx. 2.6 kg
Push operation	X
Tractor operation	X
Upright picture (UPC)	X
Correctly orientated picture	X
Zoom	10x optical, optionally 4x digital
F (shutter)	1.8 to 2.9
f (focal length) (mm)	4.2 to 42
Lighting	2x ZSW 10 with 3 power LEDs each
Light sensitivity (lux)	1.5 lux
Protection class	IP 68
Permissible ambient temperature	C - +40°C during operation
Focus function/range	autofocus
TV Standard	NTSC or PAL
Horizontal picture resolution	460 TVL
Integrated laser	✓
Integrated locator transmitter	X
Ex-protection	X
3D GeoSense	X

Combinable with

IBAK coilers / winches	KW 305/310/505 (with extension kit only)
IBAK control systems	BS 3.5, 5, 7
IBAK extension kit	✓

The **IBAK CERBERUS** is a worthwhile extension to all IBAK inspection systems for the optical condition capture of man-sized sewers. The handheld inspection camera, featuring an ergonomically designed holder, low weight and automatic shutter and focus functions that can be activated as required, is equipped with all desirable camera functions such as a 10x optical zoom, an autofocus and an automatic/manual shutter.

The CERBERUS is connected to the TV system via an extension kit. Continuous voice contact is possible between the person in the sewer and the person in the vehicle. A headset ensures interference-free communication between them.

Two durable power LED lights and the 10x optical zoom lens are particularly useful for showing up cracks and minor defects.

The projection of two laser points at a defined distance from each other makes it easy to estimate relative dimensions in the TV picture, calculate the size of cracks and thus efficiently evaluate the condition of the sewer.

RETRUS 2/RETRUS 2 HD

Rear-view camera

Deployment range DN 100 and up



- Convenient, safe operation when reversing
- Integrated LED lighting
- Internal pressure monitoring
- Optional ex-protection
- Easily retrofittable thanks to modular design (pluggable)

Technical System Data RETRUS

Classification	Rear-view camera
Deployment range	DN 100 and up
Dimensions	L 100 mm / B 60 mm / H 70 mm
Weight	approx. 1kg
Push operation	X
Tractor operation	✓
Upright picture (UPC)	✓ (fixed by the tractor)
Correctly orientated picture	✓ (fixed by the tractor)
Zoom	X
F (shutter)	2
f (focal length) (mm)	2.5
Lighting	2 white LEDs, adjustable
Light sensitivity (lux)	0.025 lux
Protection class	IP 68
Permissible ambient temperature	C - +40°C during operation
Pressure monitoring	2 integrated pressure sensors
Aperture function	fixed shutter, electronic shutter, remote-controlled
Focus function/range	fixed focus
TV Standard	PAL/NTSC, Full HD
Horizontal picture resolution	700 TVL, 1100 TVL
Integrated laser	X
Ex-protection	✓ (optional)
3D GeoSense	X

Combinable with

IBAK tractors	all tractors
IBAK control systems	all BS systems

The **IBAK RETRUS** is a rear-view camera which makes reversing easier and safer in many situations. Problematic areas detected during forward travel, such as protruding obstructions, defects and displacements are recognized when reversing so that the operator can react accordingly and prevent damage to the system.

Synchronisation between the IBAK winches and camera tractors guarantees a maximum range at a constant speed and fast automated reversing – nevertheless there are still situations where it is advisable to supervise the reversing procedure with a rear-view camera. Reversing when the winch is disengaged (with the synchronisation switched off) can also be supervised with the RETRUS so that running over the cable with the tractor can be prevented in good time.

ASPECTA 3
Manhole zoom camera
Electronic sewer mirror



The **ASPECTA** (manhole zoom camera or electronic sewer mirror) permits a view into associated sewers from a manhole without anyone having to enter it. The ASPECTA is used to check the operational status and can be utilized for instance to plan needs-based sewer cleaning and additional inspection measures. Thanks to the high zoom factor (30x optical) and adequate lighting even in larger-diameter sewers, a view is also possible into parts of sewer reaches far away from the manhole, up to a distance of 30 metres. With the integrated laser, the distance to particular points over the entire 30 metres can also be measured.

Technical System Data ASPECTA

Classification	Tilt head camera
Deployment range	DN 150 and up – DN 1200
Dimensions	Ø 123 mm, length 136 mm
Weight	system approx. 11 kg camera approx. 1,5 kg
Push operation	X
Tractor operation	X
Upright picture (UPC)	X
Correctly orientated picture	X
Zoom	30 x optical, 32 x digital
F (shutter)	1.6 – 4.7
f (focal length) (mm)	4.3 mm – 129 mm
Lighting	11 white power LEDs, reflectors 15° angle of radiation
Light sensitivity (lux)	0.5 lux
Protection class	IP 68
Permissible ambient temperature	-10°C bis +35°C in operation
Pressure monitoring	X
Aperture function	manual, automatic, remote-controlled
Panning range	unten 90°, oben 60°
Angle of rotation	–
Focus	manual 1 cm – ∞ remote-controlled, autofocus
Sensor	1/3" CMOS
TV Standard	fullHD
Horizontal picture resolution	800 TVL
Integrated laser	✓
Integrated locator transmitter	X
Ex-protection	optional, in preparation

Combinable with

IBAK tractors	–
IBAK push system	–
IBAK control systems	BP 3

Telescopic rods

Material	GRP/CRP (black)
Weight	2.4 kg (standard set of 5) / 2.6 kg (optional set of 6)
Diameter of handle/ tip	40 mm/21 mm (standard set of 5) 40 mm/17 mm (optional set of 6)
Locking system	quick fastener
Length	1.90 m – 8.15 m (standard set of 5) 1.95 m – 10.0 m (optional set of 6)

Power supply

Battery	18 VDC, 5 Ah (Li-ion), qty 1
---------	------------------------------

Operation/data transfer

=> see BPs/control consoles

Accessories

Tripod stand	aluminium, adjustable height
Manhole grating	Work grating Ø 670 mm with cut-out, weight 5,6 kg

PANORAMO SI 4K
Manhole camera
Deployment range DN 300 and up



- **4K resolution**
- **Efficient operation:** Inspection separately from analysis in the office
- **Flexible deployment possibilities:** With vehicle systems or mobile systems
- **Place-saving:** Installable in a compact van in combination with the KW SI
- **Mobile rack:** For operation at hard-to-access manholes

Technical System Data PANORAMO SI 4K

Classification	Manhole inspection
Deployment range	DN 300 and up
Dimensions	ø 250 mm / height 184 mm
Weight	approx. 7.6 kg
Protection class	IP 68
Permissible ambient temperature	C - +40°C during operation
internal operating pressure	2,0 bar
Speed	max. 35 cm/sec
Zoom	digital
Images	360°-spherical image
Lighting	Xenon flashlighting

Combinable with

IBAK cable winches	KW 310, KW 505, KW SI, KW SI 50
IBAK control systems	BS 5, BS 7, BS 10 X, Laptop (with KW SI)

With the **IBAK PANORAMO SI 4K**, the advantages of PANORAMO technology are also available for manhole inspection and permit complete, fast optical condition capture in manholes.

Two high-resolution digital cameras with distortion-free wide-angle lenses that were specially designed for this purpose scan the entire interior of the manhole in a single vertical movement and in just a few seconds. The digitally transmitted images are immediately live at the operator's disposal; condition assessment can be performed optionally in the office or directly on the job site.

Unlike a video from a conventional pan and rotate camera in which only the view in the camera's line of vision at the time of recording is saved, the IBAK PANORAMO SI 4K viewer software provides a comprehensive manhole inspection. You can stop at any position in the manhole, do a 360° pan, zoom and save still photos.

At the same time, an unfolded

view of the manhole can be generated. This provides a rapid overview of the condition of the structure and enables objects on the manhole walls to be measured. Besides this, what is known as a point cloud of geometric data is created and a 3D-model of the structure is generated from this. The PANORAMO SI manhole inspection option of the IBAK sewer analysis software IKAS is available for further evaluation. With this option, PANORAMO SI films are analysed in a simple and efficient manner. The results are inspection reports and inspection data that are suited to all commonly used data interfaces. With the licence-free IBAK viewer software, the customer also has a comprehensive overview.

The PANORAMO SI 4K can be operated as a mobile system with the KW SI, 12 metres of cable and a laptop but also equally well with vehicle-systems with the KW SI 50, the KW310 4K and the KW 505 4K with a BS 7 or BS5.



PANORAMO 4K / PANORAMO 150 4K

Camera system/3D-scanner

Deployment range DN 150 and up



Technical System Data PANORAMO 4K		PANORAMO 150 4K
Deployment range	DN 200 and up	DN 150 and up
Steering function	X	✓
Speed	continuously variable, max. 35 cm / sec.	continuously variable
Folding plug	bends horizontally and vertically	bends horizontally and vertically
Pressure monitoring	2 integrated pressure sensors	2 integrated pressure sensors
ATC	X	✓
Ex-protection	optional	optional
Viewer software	IBAK PANORAMO Viewer (Freeware)	IBAK PANORAMO Viewer (Freeware)

Combinable with

IBAK cameras	does not apply, as integrated	does not apply, as integrated
IBAK cable winches	KW 310 (4K), KW 505 (4K)	KW 310 (4K), KW 505 (4K)
IBAK control systems	BS 5, BS 7, BS 10 X	BS 5, BS 7, BS 10 X

ATC = Automatic Tilt Compensation = electronic stabilizing function

The **IBAK PANORAMO 4K** system takes hemispherical photos with two high-resolution 4K digital cameras that are equipped with 185° fisheye lenses and mounted at the front and rear of the camera tractor. These photos are then put together to form 360° spherical images, thus enabling views from all angles to be displayed. The real 3D interior view of the entire pipe can also be evaluated at any time in the office, separately from the actual inspection. The xenon flash-lighting that was specially developed by IBAK for PANORAMO technology ensures pin sharp images in spite of the high inspection speed of up to 35 cm per second.

As inspection results, you receive a 3D film, an unfolded view (view of the unfolded interior of the pipe in 2D) and, if required, video sequences. This technology forms the basis for the comprehensive identification, documentation and measurement of defects and the use of PANORAMO ArtIST (Artificial Intelligence Software Tool). PANORAMO ArtIST is built upon software which recognises defects and laterals, etc. automatically using artificial intelligence techniques and helps users to identify and document defects more efficiently and partly automatically. PANORAMO technology provides an optimum basis for this because 100% of the pipe is analysed.

LISY

Lateral inspection system

Deployment range DN 150 and up in main sewers, DN 80 and up in laterals



The IBAK LISY 3 is a lateral inspection system that can be used in main sewers with diameters of DN 150 upwards. Laterals with diameters of DN 80 and up can be inspected from main sewers.

Various flushing nozzles are available for cleaning and inspection in a single operation; with the corresponding camera, the LISY system is 3D-GeoSense capable so that the inspection and the pipe run scan can be performed in one step.

- Flexibly deployable in various pipe diameters
- Folding joint for easy insertion into pipes
- Combinable with numerous IBAK push rod cameras
- Deployable in purely electric push rod operation and in flushing mode
- High, continuously selectable propulsion speed
- Optional ex-protection
- Can be used with 3D-GeoSense and hydrostatic height measurement
- Practical handling thanks to the LISY lift for height adjustment
- Installation without use of tools through fast exchange funnels as an aid for positioning the camera in laterals

Technical System Data

Deployment range	DN 150 and up (T 76), DN 200 and up (T 86)
Steering function	✓
Speed	depending on the tractor used
Folding plug	✓
Pressure monitoring	✓
ATC	✓
Ex-protection	optional
Height adjustment	LISY lift, alternatively by conventional means

Combinable with

IBAK cameras	NANO, NANO L, POLARIS, ORION, ORION L, ORION 3, ORION 3L
IBAK tractors	T 76, T 86, T 76 HD, T 86 HD
IBAK coilers / winches	KW LISY Synchron plus KW 305 / 310 / 505
IBAK control systems	BS 3.5, 5, 7, 10 X



T66/T76 (HD)
Camera Tractor
 Deployment range DN 100 and up/150



**EASY
TO
USE**

Technical System Data T66/T66 HD		T76/ T76 HD
Classification	Camera tractor	Camera tractor
Deployment range	DN 100 and up	DN 150 and up
Weight	approx. 9 kg (with rim 93 and CC2.1)	approx. 21 kg (with rim 93 and CB3)
Steering function	✓	✓
Speed	continuously variable	continuously variable
Folding plug	bends horizontally and vertically	bends horizontally and vertically
Protection class	IP 68	IP 68
Pressure monitoring	2 integrated pressure sensors (LCD indicator and acoustic alarm in the control unit)	2 integrated pressure sensors (LCD indicator and acoustic alarm in the control unit)
ATC	✓	✓
Tilt measurement	✓ (optional)	✓ (optional)
Temperature measurement	✓ (optional, via temperature measurement module)	✓ (optional, via temperature measurement module)
Ex-protection	✓ (optional)	✓ (optional)
IBAK camera connection	CC1.1/ CC1.1HD (pivoted and hinged), CC2.1/ CC2.1HD (fixed), CC 5.1/ CC 5.1HD (vertically adjustable and for additional light operation)	Typ CB 3, CB 3.2 S, CB 3.2 S Ex (HD)
Electrical height adjustment	-	✓ (Lift height up to 210 mm)

Combinable with		
IBAK cameras	all IBAK (HD) tractor cameras	all IBAK (HD) tractor cameras
IBAK cable winches	KW 310 (HD), KW 505 (HD)	KW 310 (HD), KW 505 (HD)
IBAK control systems	BS3.5, BS5, BS 7, BS 10 X, BS 10 X0, HD: BS5, BS 7, BS 10 X	BS3.5, BS5, BS 7, BS 10 X, BS 10 X0, HD: BS5, BS 7, BS 10 X

ATC = Automatic Tilt Compensation

- Modular system
- Short setup times (QuickX wheels)
- Maximum ruggedness
- Optional ex-protection

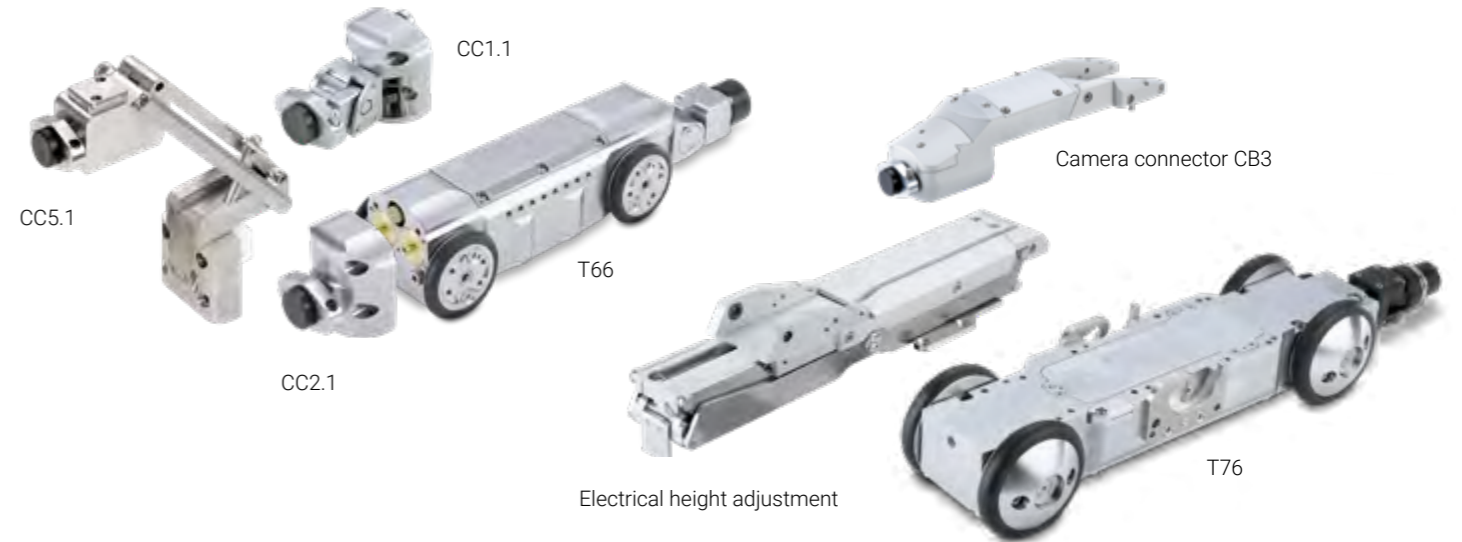

Wheel sets for T66 and PANORAMO 150



Wheel 52
for hard pipe materials, e.g. concrete, plastic, vitrified clay



Wheel 70
for hard pipe materials, e.g. concrete, plastic, vitrified clay



Wheel 93-66
for hard pipe materials, e.g. concrete, plastic, vitrified clay



Wheel 122-6
for hard pipe materials, e.g. concrete, plastic, vitrified clay



Wheel 140-6
for hard pipe materials, e.g. concrete, plastic, vitrified clay



Wheel 75 PUR
for hard pipe materials, e.g. concrete, plastic, vitrified clay



Wheel 105 PUR
for hard pipe materials, e.g. concrete, plastic, vitrified clay



Wheel 118 PUR
for hard pipe materials, e.g. concrete, plastic, vitrified clay



Wheel 75 NBR
for hard pipe materials, e.g. concrete, plastic, vitrified clay



Wheel 105 NBR
for hard pipe materials, e.g. concrete, plastic, vitrified clay



Wheel 118 NBR
for hard pipe materials, e.g. concrete, plastic, vitrified clay



Granulated wheel 75
for hard, smooth pipe materials, e.g. landfill pipes and vitrified clay



Granulated wheel 105
for hard, smooth pipe materials, e.g. landfill pipes and vitrified clay



Granulated wheel 120
for hard, smooth pipe materials, e.g. landfill pipes and vitrified clay



Tungsten carbide wheel 57
for soft pipe materials, e.g. inliners



Tungsten carbide wheel 70
for soft pipe materials, e.g. inliners



Tungsten carbide wheel 93-66
for soft pipe materials, e.g. inliners



Wheel 78
universally deployable for hard pipe materials



Wheel 78
universally deployable for hard pipe materials



Wheel 93
universally deployable for hard pipe materials, e.g. concrete, plastic, vitrified clay



Wheel 108
universally deployable for hard pipe materials, e.g. concrete, plastic, vitrified clay



Wheel 130
universally deployable for hard pipe materials, e.g. concrete, plastic, vitrified clay



Wheel 122 PUR
universally deployable for hard pipe materials, e.g. concrete, plastic, vitrified clay



Wheel 122 NBR
universally deployable for hard pipe materials, e.g. concrete, plastic, vitrified clay



Tungsten carbide wheel 78
for soft pipe materials, e.g. inliners



Tungsten carbide wheel 120
for soft pipe materials, e.g. inliners



Granulated wheel 100-4
for hard, smooth pipe materials, e.g. landfill pipes and vitrified clay



Granulated wheel 120
for hard, smooth pipe materials, e.g. landfill pipes and vitrified clay



Granulated wheel 150
for hard, smooth pipe materials, e.g. landfill pipes and vitrified clay



Air tyres 200 x 50
for all kinds of big profiles



Air tyres 3.00-4
for all kinds of big profiles



Air tyres 4.00-4
for all kinds of big profiles

MicroGator/MicroGator 150

Electric cutter

Deployment range DN 150 and up (relined)



The IBAK vehicle system for electric cutting and rehabilitation tasks in main sewers.

- **Effective cutting:** Through precise control of the cutting process
- **Reliable in operation:** Power-driven, low-noise operation
- **Safe investment:** Flexible and future-proof thanks to modular system design
- **Added value:** Installation of top hats and cuffs, lateral connection repair with mortar, ultra-high-pressure cutting and inspection
- **Ready for immediate use:** Turnkey solution

The **MicroGator/MicroGator 150** is a cutting robot for main sewers with diameters of DN 150/DN 200 (relined) to DN 800. It is equipped with an efficiently working electric motor which in spite of its small size is more powerful than commonly used air and hydraulic cutters. No power-consuming generators or loud compressors are required to operate the cutter. Batteries that can be recharged and operated at low cost and in an environmentally friendly manner are sufficient for daily work.

All materials to be found in sewers can be reliably processed with the different cutter heads; more distant working areas deeper in laterals can be accessed with cutter shaft extensions. Different-sized motors enable work to be performed deep in laterals even in small main sewers.

MicroGator Air

Pneumatic cutter

Deployment range DN 200 and up (relined)



The IBAK system for pneumatic cutting and rehabilitation tasks in main sewers.

- **Effective cutting:** Through precise control of the cutting process
- **Reliable in operation:** Pneumatic and powerful
- **Safe investment:** Flexible and future-proof thanks to modular system design
- **Added value:** Installation of top hats and cuffs, ultra-high-pressure cutting and inspection
- **Variable operation:** In a vehicle and as a mobile rehabilitation system

For **mobile operation**, the control console BP100 is used in combination with the KW206/306. This equipment configuration permits user-friendly operation and offers a high measure of flexibility for many different applications.



Overview of cutting robots and equipment carriers



Technical System Data	MicroGator	MicroGator 150 with cutter head	MicroGator 150 with carrier head	MicroGator GT	MicroGator Air	MicroGator GT Lite
Deployment range	Main sewers	Main sewers	Main sewers	Main sewers	Main sewers	Main sewers
Pipe diameter	DN 200 (relined) to DN 800	DN 150 (relined) to DN 300	DN 150 (relined) to DN 300	DN 200 (relined) to DN 800	DN 200 (relined) to DN 800	DN 200 (relined) to DN 800
Length ¹	104 cm	84 cm	84 cm	104 cm	104 cm	104 cm
Inflexible length ²	72 cm	60 cm	60 cm	72 cm	72 cm	72 cm
Minimum circumscribed circle	Body 150 mm, 160 mm over the wheels	Body 112 mm, 130 mm over the wheels	Body 112 mm, 130 mm over the wheels	Body 150 mm, 160 mm over the wheels	Body 150 mm, 160 mm over the wheels	Body 150 mm, 160 mm over the wheels
Weight	55 kg	32 kg	32 kg	49 kg plus adapter for rehabilitation system	53 kg	49 kg plus adapter for rehabilitation system
Operation	BS 7, BS 10 X	BS 7, BS 10 X	BS 7, BS 10 X	BS 7, BS 10 X	BS 10 X/BP 100	BS 10 X/BP100
Maximal range	150m of hybrid cable	150m of hybrid cable	system-dependent	system-dependent	up to 300m	system-dependent

Tractor						
Power	200 watts	150 watts	150 watts	200 watts	200 watts	200 watts
Motors	2 electric motors	2 electric motors	2 electric motors	2 electric motors	2 electric motors	2 electric motors
Maximum speed	15m/min	12m/min	12 m/min	15 m/min	15m/min	15m/min
Shear modulus, rotating angles	400°	450°	450°	400°	400°	400°
Traction	implemented with various wheel sets and additional weights	implemented with various wheel sets and additional weights	implemented with various wheel sets and additional weights	implemented with various wheel sets and additional weights	implemented with various wheel sets and additional weights	implemented with various wheel sets and additional weights
Length of stroke of raising/lowering unit	200 mm	160 mm	160 mm	200 mm	200 mm	200 mm

Working equipment						
Type	electric cutting system, water-cooled	system with exchangeable heads with electric cutting motor, water-cooled	system with exchangeable heads for various rehabilitation tasks	adapter system for various rehabilitation tasks	pneumatic cutting system	adapter system for various rehabilitation tasks

Easy handling and safety						
Lowering hook with chain hoist	✓	✓	✓	✓	✓	✓
Sewer ventilation system	✓	✓	✗	✗	✗	✗
Pressure monitoring	✓	✓	✓	✓	✓	✓
Monitoring camera	CutterCam	CutterCam	CutterCam	CutterCam	CutterCam	CutterCam
Rear-view camera	optionally in hybrid cable	optionally in hybrid cable	optionally in hybrid cable	optionally in hybrid cable	✓	✓
Camera lens cleaning	air/water	air/water	air/water	air/water	air/water by using the ST50 GT hose drum	air
Front camera	can be mounted on the cutting motor	✗	✗	✗	✗	✗
Inspection	mounting adapter for ORION	✗	✗	✗	✗	✗
Ultra-high pressure water jet cutting	✗	✗	✓	✓	✗	✓
Top hat installation	✓	✗	✓	✓	✓	✗
Cuff installation	✓	✗	✓	✓	✓	✗
Lateral connection repair with mortar	✓	✗	✗	✓	✗	✓

¹ from cutting motor to articulated joint

² from front edge of the tractor to articulated joint

Cable winches

Winches for vehicle installation

300-600 metres of cable

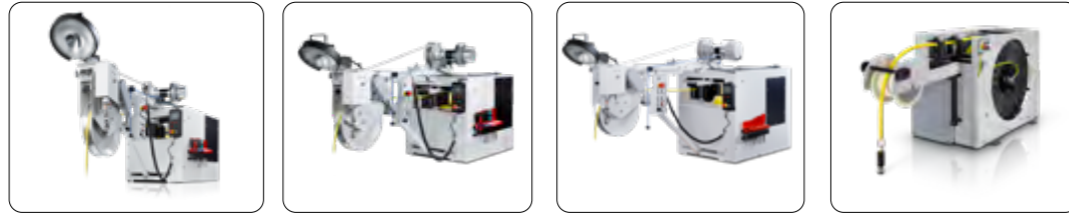

Technical System Data	KW305	KW310	KW505	LISY Synchron
Classification	Cable winch	Cable winch	Cable winch	LISY Cable winch
Full automatic	✓	✓	✓	✓
Motor-driven	✓	✓	✓	✓
max. cable length	300 m	300 m	500/600 m	180 m (incl. 40m Push Rod)
Length measurement/indicator	✓	✓	✓	✓
Cable level wind device	✓	✓	✓	✓
Remote control	✓	✓	✓	✓
Emergency stop switch	✓	✓	✓	✓
Hoist ¹	✓	✓	✓	✓
Work place light	✓	✓	✓	✗

Combinable with

IBAK cameras	all IBAK cameras	all IBAK cameras	all IBAK cameras	all IBAK cameras
IBAK tractors	T66 / T76 / T86	all IBAK tractors	all IBAK tractors	all IBAK tractors
IBAK control systems	BS 3.5	BS 5, BS 7, BS 10 X	BS 5, BS 7, BS 10 X	BS 5, BS 7, BS 10 X
IBAK camera systems	all except PANORAMO	all IBAK camera systems	all IBAK camera systems	all lateral cameras
IBAK extension kit	✓	✓	✓	✓

¹ to introduce the camera into the manhole

The IBAK KW 305, KW 310 and KW 505 are fully automatic, motor-driven cable winches that hold up to 600 m of camera cable. They are designed for operation with IBAK camera tractors and cameras and the LISY system. The IBAK camera systems PANORAMO 4K, PANORAMO 150 4K and PANORAMO SI 4K can be operated fully digital as also the IBAK full HD cameras with the KW 310 and K505. The winches synchronise camera tractor and cable winch operation with the integrated traction regulating device: the cable is wound on and off the winch in accordance with the speed of the camera tractor. This prevents the camera tractor from running over the camera cable

and at the same time ensures that it reverses at a consistent speed. The swivel boom of the winches enables the camera system to be properly positioned over the manhole; the camera system is then lowered into the manhole with the hoist, and an automatic cable guide device ensures that the cable is always wound evenly onto the winch. The cable winches KW 310 and KW 505 transmit the image digitally (HDSDI), loss-free and without interference. For this, a robust fibre optic cable is used in full HD operation and for PANORAMO systems. The KW 305 is equipped with a coaxial cable for analogue video transmission.

KW SI

Cable winch for the PANORAMO SI

12 m of cable



The cable winch KW SI enables flexible operation with the manhole camera PANORAMO SI 4K. The winch can be installed space-savingly in a vehicle but it can also be used in a mobile rack with a laptop. It combines the advantages of a mobile system with those of a compact vehicle-based system for efficient manhole inspection from the van.

The winch can be easily removed from the vehicle with the mobile rack by means of the quick fastening system and converted into a mobile system in a few steps. All components of the mobile system are designed for outdoor operation: with the big air tyres, even hard-to-access manholes can be reached; the laptop for operation of the system is particularly robust and splashproof. Power is supplied by powerful exchangeable batteries or from a lithium battery installed in the vehicle.

KW SI	
Classification	Cable winch
Max. cable length	12 m
Width x height x depth in mm	280x400x400mm
Weight	approx. 16 kg incl. cable
Length measurement/indicator	✓
Motor-driven	✓
Cable level wind device	✓
Remote control	✗
Emergency stop switch	✓
Combinable with	
IBAK cameras	PANORAMO SI 4K
IBAK tractors	-
IBAK control systems	Laptop



KT156

Cable winch for MainLite easy
150/180 m of cable



MainLite easy

The MainLite easy is a portable system with 150/180 m of cable and consists of the control console BP 100 and the electrically driven cable winch KT 156.

The KT 156 holds 150/180 metres of camera cable. Winding on the cable is supported by a drive motor. The compact design, the big wheels and the folding transport handle make inspections possible at hard-to-access locations that cannot be reached with a vehicle or even with the MainLite fit. The low weight enables the system to be transported by a single person. For operation, only a 230 volt power outlet or a suitably sized lithium battery is required.

KT 156

Classification	Cable winch
Deployment range	DN 100 and up
Max. cable length	150 m/180m
Width x height x depth	420 x 660 x 770 mm
Weight	approx. 41 kg without the BP100 approx. 45 kg with the BP100
Length measurement	✓
Motor-driven	✓
Cable level wind device	✗
Remote control	✗
Emergency stop switch	✗

Combinable with

IBAK cameras	all analogue IBAK cameras
IBAK tractors	T66, T76
IBAK control systems	BP 100

KW 206/306

Cable winches for MainLite fit
200/300 m of cable



MainLite fit

The MainLite fit consists of a cable winch (**KW206/KW306**) with up to 300 m of cable, a mobile rack and the control console BP100. The motor-driven winches with 200 metres (KW206) or 300 metres of camera cable (KW 306) can be transported to locations that are difficult to access with a vehicle by means of the mobile rack. With the integrated seat, work can also be performed comfortably outside the inspection van.

KW 206/306

Classification	Cable winch
max. cable length	200 m / 300 m
Width x height x depth in mm	cable winch only: KW 206: 360x410x650 KW 306: 430x410x650 with the mobile rack KW 206: 550x300x970 KW 306: 550x300x970
Weight	KW 206: approx. 44 kg incl.cable KW 306: approx. 54 kg incl.cable mobile rack approx. 12 kg
Length measurement/indicator	✓
Motor-driven	✓
Cable level-wind device	✓
Remote control	✗
Emergency stop switch	✓

Combinable with

IBAK cameras	all analogue camera models
IBAK tractors	T 66, T 76
IBAK control systems	BS 10, BP 100



BP2, BP100

Control consoles



Bedienpult	BP2	BP100
Width x height x depth	337x190x40 mm	405x190x40 mm
Weight	approx. 2,8 kg	approx. 3,0 kg
Connections	2x USB 3.0 1x HDMI	2x USB 3.0 1x HDMI 1x USB 2.0
Data storage	Text input or storage of image or video files (MPEG 4 AVC/H.264) on the integrated PC, data exchange via USB 3.0 or WLAN	Text input or storage of image or video files (MPEG 4 AVC/H.264) on the integrated PC, data exchange via USB 3.0 or WLAN
Monitor	Dustproof and splashproof (IP55), 10-inch touch display, external monitor connectable via HDMI	Dustproof and splashproof (IP55), 10-inch touch display, external monitor connectable via HDMI
Battery level indicator	✓	✓
Battery change indicator	✓	✓
Length measurement/indicator	✓	✓

Combinable with

IBAK cameras	BP2	BP100
	AxialCam	AxialCam
	NANO, NANO L	NANO, NANO L
	POLARIS	POLARIS
	ORION, ORION L	ORION, ORION L
	ASPECTA 1	ASPECTA 1
		ORPHEUS 2/3
IBAK push systems	MiniLite	MiniLite
IBAK tractors		T66, T76
IBAK cutters		MicroGator AIR
IBAK cable winches		KT 156, KW 206, KW 306
IBAK software	IKAS recorder (standard), IKAS mini, IKAS evolution (depending on the configuration of the end device, software licences are possible for IKAS evolution Push, IKAS evolution Starter and IKAS evolution Professional)	
Power pack	18VDC 4 Ah (Li-Ion), qty 2 (not included in the scope of supply)	

The control console models **BP2** and **BP100** come with a touch display and are used to operate the software and the IBAK cameras and camera tractors. Both control consoles are equipped with powerful PCs so that the complete IBAK sewer analysis software can be installed and used with all functions.

The BP 2 has been optimised for the operation of the MiniLite and ASPECTA 1 systems.

The control console BP100 is equipped with two joysticks with which both cameras and camera tractors can be operated. For this, the BP100 is either connected directly to the compact system to be operated or installed in the vehicle by means of a vehicle extension (consisting of an emergency stop button for the BP100 and a table mounting device). For all BP models, there is a large selection of accessories such as display extensions and extension cables.

MiniLite

Compact push rod camera system

Deployment range DN 50 and up



MiniLite

The **IBAK MiniLite** is a compact push rod camera system for the inspection of house and estate drainage systems. Thanks to its modular extendibility and numerous accessories, a wide range of applications are possible; the cameras are also compatible with other IBAK systems.

The push rod drum can be exchanged in only a few steps and can thus be adapted to the specific inspection requirements at any time. Depending on the requirements, the system can be additionally equipped with an extension kit for operation with vehicle-based systems and the corresponding software.

If the 80-metre push rod is used in combination with an ORION, NANO or POLARIS camera, diameter measurements can be optionally performed. IKAS recorder software is available for simple projects without any complicated data exchange formats; if inspections of sewer systems are to be made in compliance with the EN 13508-2 standard which is valid in Europe, IKAS mini can be installed. If particular data exchange formats are required or if a 3D site plan is to be generated after a 3D-GeoSense pipe run measurement has been performed, the use of complete IKAS evolution software is recommended.

The MiniLite is standardly supplied with a 500/10 exchange drum with 80 metres of Perfect Push Rod with which a long range can be achieved. Alternatively, exchange drums with the shorter Magic Pushrod which has particularly good bend-passing capabilities are available. If a solution with bend-passing capability is required in particularly small diameter pipes, the 500/12 models with a permanently installed AxialCam and 30 metres of push rod are to be recommended. Push rods are also optionally available with a 512 Hz locator transmitter or can be retrofitted with one.

Technical System Data MiniLite

Classification	Compact push rod camera system
Perfect Push Rod	80 m (exchange drum 500/10)
Monitor	dustproof and splashproof (IP55), 10-inch touch display with protective glass cover
Data storage	Text input or storage of image or video files (MPEG 4 AVC/H.264) on the integrated PC, data exchange via USB 3.0
Length measurement/indicator	✓
Power pack	18VDC 4 Ah or 5 Ah (Li-Ion), qty 2

Combinable with

IBAK cameras	AxialCam, POLARIS, ORION, ORION L, ORION 3, ORION 3 L, NANO, NANO L
IBAK extension kit	✓
3D GeoSense	✓

Software versions for control consoles BP2 and BP100



Functions	IKAS recorder	IKAS mini	IKAS evolution
Project management	X	X	✓
Sewer database	X	✓	✓
Video recording	✓	✓	✓
Video overlay (by hotkey and text input)	✓	✓	✓
Video overlay from sewer database	–	✓	✓
Individual photos	✓	✓	✓
Condition codes to standard (EN13508,WRC)	X	✓	✓
Sewer data interface	X	X	✓
internal operating pressure			
Video and photo files	✓	✓	✓
Inspection video player with data index and PDF reports	X	✓	✓
Complete sewer data viewer program (reports, films, photos, MAP/GIS)	X	X	✓
Optionen			
DN measurement	✓	✓	✓
Measurements	X	X	✓
MAP (GIS)	X	X	✓
Further IKAS evo options	X	X	✓

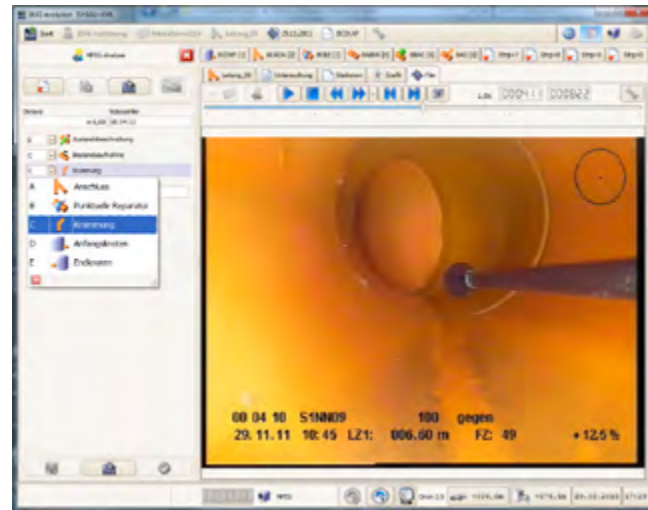

Creating projects and generating reports

All control consoles are equipped with the IKAS recorder software program. This basic software package already permits videos and images to be captured, saved and passed on.

With IKAS mini, inspections of wastewater facilities can be recorded in compliance with the EN 13508-2 standard, which is valid in Europe, or Wrc. Condition and defects data of sewer reaches and manholes and photo and video recordings can be easily entered and saved thanks to intuitive menu guidance.

The results of the inspection are documented in well-structured reports and stored as a PDF. Data can be simply transferred to the customer by means of a USB stick or by WLAN. It is thus possible to view the defects data and the corresponding videos and photos in a clearly arranged presentation. In this way, all defects in sewer pipes are identifiable and unambiguous. IKAS mini allows the inspector flexibility during inspections without tying him down to rigid sets of rules.

If inspections are to be performed according to municipal specifications or for particular data exchange formats (such as DWA-M 150), an upgrade to IKAS evolution can be purchased at any time. IKAS evolution offers the possibility of buying specific licences for each application. On the following pages you will find a rough overview of the possibilities of the IKAS evolution licences.

Software licences Dongle/device recognition



Anlage		IKAS recorder	IKAS mini	IKAS evolution Push	IKAS evolution Starter	IKAS evolution Professional
Push rod and manhole operation	MiniLite	✓	✓	✓	✓	✓
	ASPECTA	✓	✓	✓	✓	✓
Mobile system in tractor operation	KW206/306 (MainLite fit) + BP100	✓	✓	X	✓	✓
	KT156 (MainLite easy) + BP100	✓	✓	X	✓	✓
Vehicle-based in tractor operation	KW206/306 (MainLite solid) + PC+ BS 10 X	✓	✓	X	X	✓

Software licences for IKAS evolution Push, IKAS evolution Starter and IKAS evolution Professional are possible, depending on the configuration of the user's end devices.



Contact persons
Consulting and sales

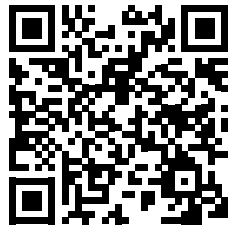

IBAK



230731_Gesamtprospekt
Fotos: Uwe Reicherter, <https://uwe-reicherter.de/> (Produktfotos),
Oliver Maier, www.olivermaier.com/(Anwenderfotos)