

Pneumatic actuator



FLOWTEKNIK
SCANDINAVIA APS



Actuation

Pneumatic actuator

General

COMPACT
actuator

ESD system

Interfaces

Ordering
code system

Introduction

Proven advantage

The COMPACT actuator is a quarter-turn rack & pinion pneumatic actuator that doubles the torque of standard pneumatic actuators. The superior performance is achieved by Habonim's patented four piston design, which generates torque around a centrally located piston. This translates into double the power for the same size actuator or half the size for the same amount of power.

Space saving, fast acting

The COMPACT has four small cylinders, each located on one of the four sides of the cube. The smaller pinion and shorter travel distance of the pistons in the COMPACT require less air pressure than a larger double-piston actuator to produce the same torque output. The end result is faster response times for emergency shutdown, lower air pressure for operation and reduced maintenance.



Technical summary

Pressure range	20-120 PSI (1.5 - 8 bar) for Double Acting (DA) actuators 30-120 PSI (2- 8 bar) for Spring Return (SR) actuators
Size range	C15, C20, C25, C30, C30M, C35, C35M, C45, C45M, C60, C60M, C75, C75M
Operating temperature	NBR -20 °C to 80 °C (-4 °F to 176 °F) Viton -20 °C to 120 °C (-4 °F to 250 °F) EPDM -40 °C to 80 °C (-40 °F to 176 °F) NBR FX428 -53 °C to 100 °C (-63 °F to 213 °F)
Compressed gas	Air, Nitrogen, CO ₂ , Natural gas (sweet)

Standards of compliance

Factory certification	ISO 9001-2008	Quality management system
Actuator design	ISO 5211 VDI/VDE 3845 (NAMUR)	Industrial valves - part-turn actuator attachments Industrial process control - pneumatic control valves - Interfaces of valves and auxiliary equipment
Certifications	ATEX 94/9/EC DNV IEC 61508-2 SIL 2/3	equipment and protective systems intended for use in potentially explosive atmospheres Rules of classification of ships 'Det Norske Veritas' offshore standards Safety integrity level - functional safety of electrical/ electronic/programmable electronic safety-related systems (optional for actuated unit only)
Documentation	EN 10204 2.2 / 3.1 / 3.2	Metallic materials - types of inspection documents

Main pneumatic actuator features

Balanced forces

The cube-shaped configuration positions the pistons in a way that allows each piston to develop thrust along its own axis with zero side load. This efficient design eliminates the use of guide rods and thrust bearings. The result is less stress on the seals than off-axis piston thrust, which is caused by the piston side loading that is inherent in the geometry of traditional actuator configurations.

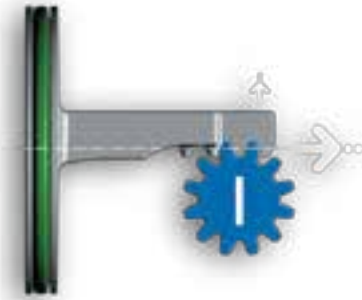

Less wear

The COMPACT's unique 4-piston design achieves a more uniform load distribution than standard single- or double-piston actuators, therefore greatly reducing the wear on gears at the points of contact between rack and pinion. The force-balanced, shorter-stroke piston prevents uneven wear of O-rings, gears and pistons. This design eliminates the need for bearings and guiding rods and reduces the number of soft parts, thereby resulting in longer maintenance schedules and lower cost of repair kits. The surface of the four cylinders is hardened by an anodizing treatment, which protects their high surface finish.

Superior corrosion resistance

The body and covers are anodized internally and externally to protect against corrosive atmospheres tested to more than 336 hours of life in a salt spray bath. An external epoxy base layer and a second layer of polyurethane paint provide additional protection against aggressive environments. Optional: Electroless-Nickel (EN) coating of body, covers and pistons.

Less air consumption

Fast action is one of the most attractive features of the COMPACT 4-piston actuator. The distinctive four-piston design allows for a smaller diameter actuator pinion that significantly shortens piston travel and response time.



Fast action

Fast action is one of the most attractive features offered by the COMPACT 4-piston actuator. The unique four-piston design allows for a smaller diameter actuator pinion that significantly shortens piston travel, resulting in a shorter response time.

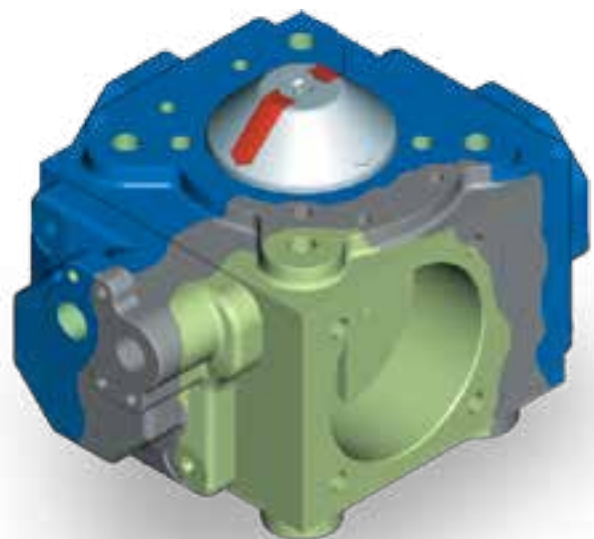

Actuation

Pneumatic actuator	General	COMPACT™ actuator	ESD system	Interfaces	Ordering code system
---------------------------	---------	----------------------	------------	------------	-------------------------

Spring return and double acting configurations

The COMPACT can be configured for either spring return or double-action operation. In both cases the air supply to drive the pistons flows into Port A of the NAMUR cover. Port A is connected to the center chamber, and Port B is connected to the four outside chambers.



Spring return (fail-safe)

Pressure entering Port A to open:
Center chamber is pressurized and pistons move outward
Springs are compressed
Pinion rotates counterclockwise

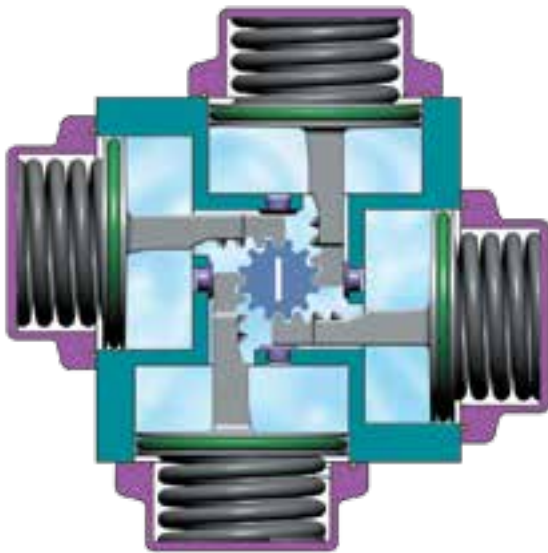
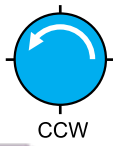

Pressure exiting Port A to close:
Air released from center chamber
Springs drive pistons inward
Pinion rotates clockwise

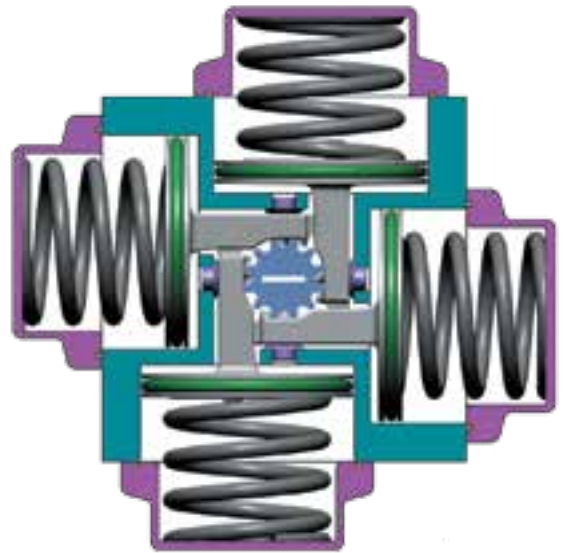
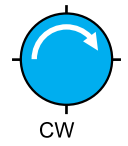

Double action (increased torque)

Pressure entering Port A to open:
Center chamber is pressurized
Pistons move outward
Pinion rotates counterclockwise

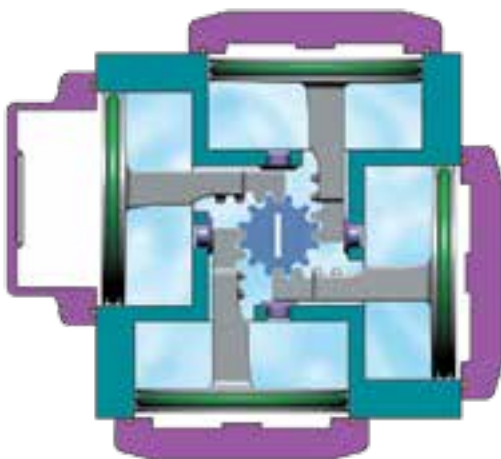

Pressure entering Port B to close:
Outside chambers are pressurized
Pistons move inward
Pinion rotates clockwise

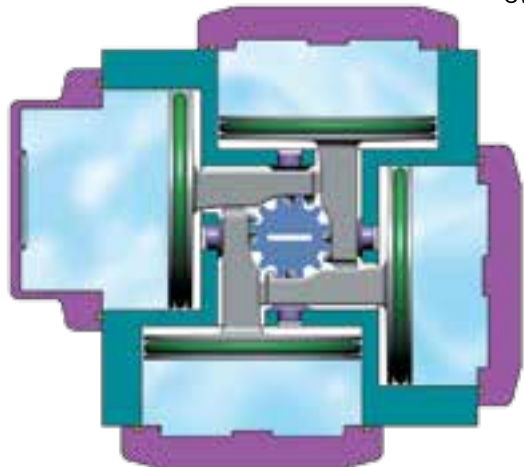
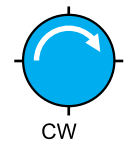

Main pneumatic actuator components

Pinion

The pinion has a double-square female drive on its bottom plane that complies with ISO 5211 standard. The top plane has the NAMUR slot for attachment to switches or positioners. There is a machined flat below the NAMUR interface to enable manual operation of the actuator with a wrench. The pinion is made from carbon steel with Electroless-Nickel (EN) plating that results in a hard-wearing surface with added protection against corrosive environments.



Limit stop

The pinion and stop rotation can be adjusted by four large-diameter, diametrically-opposed adjustable set-screws that are threaded into the actuator body. Each opposing pair of screws exerts simultaneous and equal force on opposite sides of the stop when the rotation limit is reached, thus preventing the generation of off-center forces. The stop screws allow for +/-5° rotation adjustment in both directions of travel. Larger span can be achieved with a longer set of stop screws. This feature is built into the actuator stop mechanism and eliminates the need for additional plates and screws. The stop material is stainless steel for better wear and corrosion resistance.



Indicator & puck

A highly visible indicator with flow direction arrows is snapped on to the pinion, to provide easy identification of the valve position. These indicator arrows allow true positioning of any type of valve porting. The modular design makes it easy to change the indicator to match various flow pattern.



Safety features

The COMPACT's built-in safety features ensure secure and safe operation. Assembly and dismantling of the actuator are simple tasks. Long cover-bolts for spring return actuators relieve the spring load before they disengage from their threads. Before the pistons can be removed, the stop screw must be released and the pinion removed thus ensuring that any trapped and potentially hazardous pressure in the body will escape.

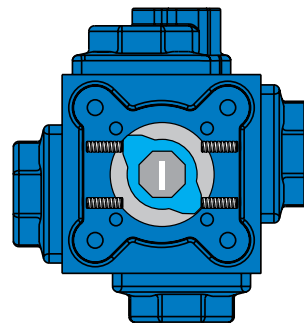

Close

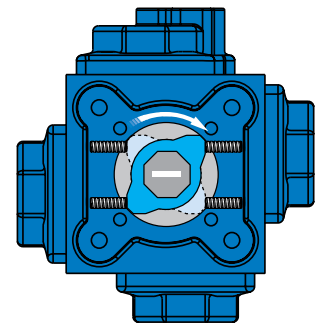

Open

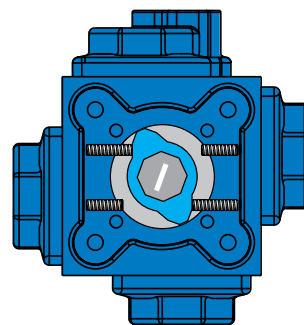

Partially closed

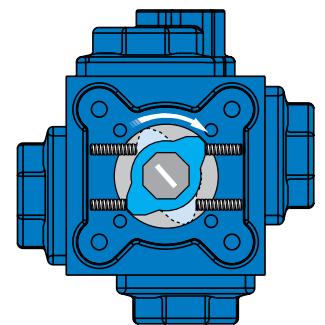

Partially open

Nested springs

The COMPACT can be used with up to three different spring sizes for the spring that, in each of the four cylinders, is nested between the cover and the piston and aligned by a centering ring. Each spring is wound in the opposite direction to its neighbor to avoid entanglement. All the springs act at the piston center axis so that no side load will occur if one spring fails to operate. By virtue of the four-cylinder design, there are many more spring combination possibilities than with double piston actuators, providing superior solutions for any air supply pressure required. Special painting of the springs provides higher corrosion resistance to the environment, resulting in more than 250 hours of life in a salt spray bath.

Spring cartridge

Using a modified spring set in a cartridge improves the torque characteristics of the COMPACT actuator. A spring cartridge is available only in the C30M, C35M, C45M, C60M and C75M actuators. Modifications include deeper covers to allow sufficient volume for the spring cartridge, thereby increasing the overall dimensions of the actuator. The spring cartridge is comprised of a shaped tube in which the extended springs have been preloaded and are held safely in place by two rigid discs. Changing a spring set configuration in this design requires changing the complete cartridge.

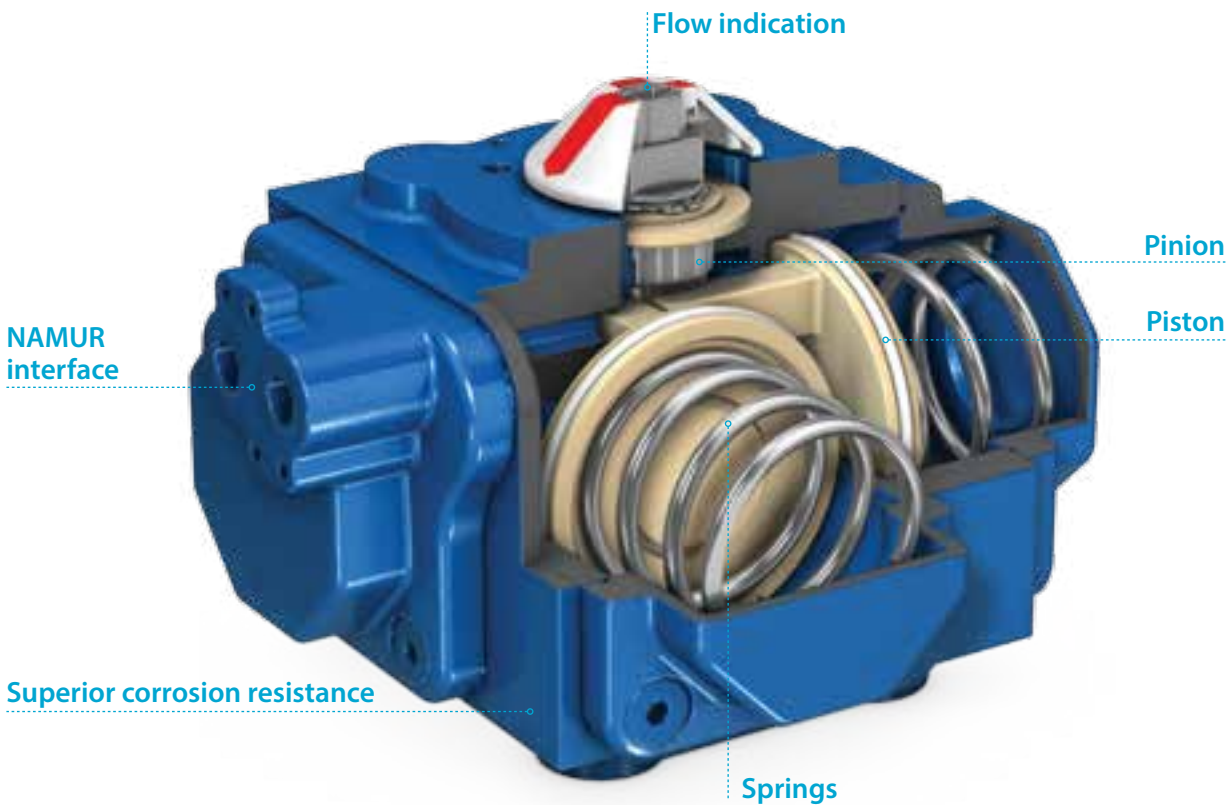

Spring combinations

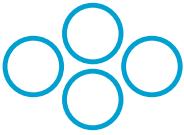

C15 only

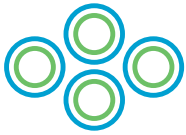

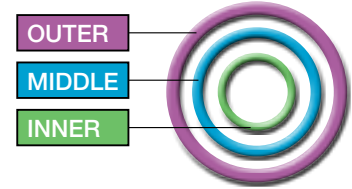
Code	Spring combinations
1A	
1B	

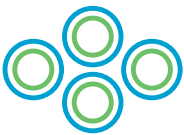

Code	Spring combinations
1B2	
2	

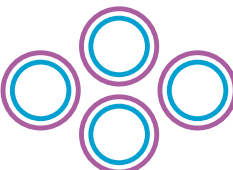

C20-C75M

Code	Spring combinations
2AB	
2A	
2A2B	

Code	Spring combinations
2B	
2A3	
2C	

Code	Spring combinations
2C3	
3	

Sizing a spring return actuator requires that the torque output at the start and end of both the spring and air drive strokes is greater than the valve torque at that position.

Pneumatic actuator	General	COMPACT™ actuator	ESD system	Interfaces	Ordering code system
---------------------------	---------	----------------------	------------	------------	-------------------------



NAMUR output drive for limit switches and positioners

Springs painted for protection and fitted coaxially in a chamber. Various spring combinations are available to suit varying air pressure requirements



NAMUR VDI/VDE 3845 connection to limit switches



Smaller in the overall size compared to double piston actuators



Rugged body construction, anodized and with a double layer coating for protection against corrosion



Spring cartridge: The modified spring set design improves the torque characteristics of the COMPACT actuator

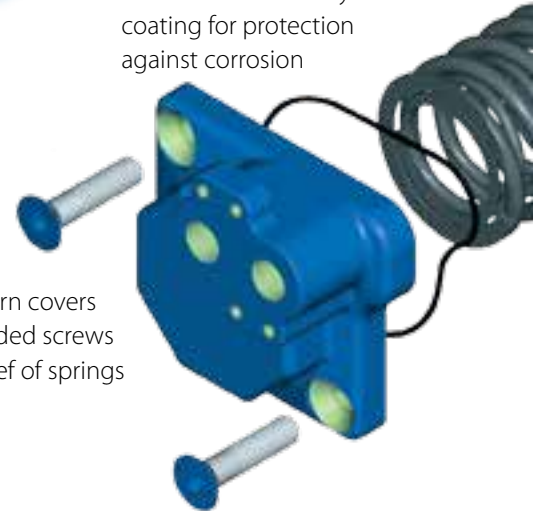

Spring return covers with extended screws for safe relief of springs

NAMUR interface for solenoid mounting

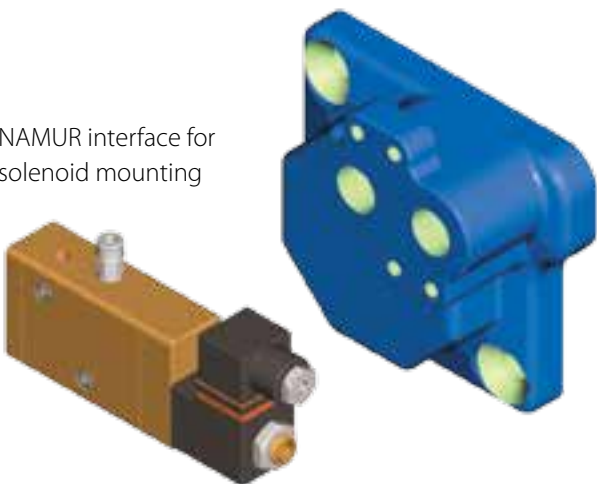

Limit stop for open-close and intermediate positions

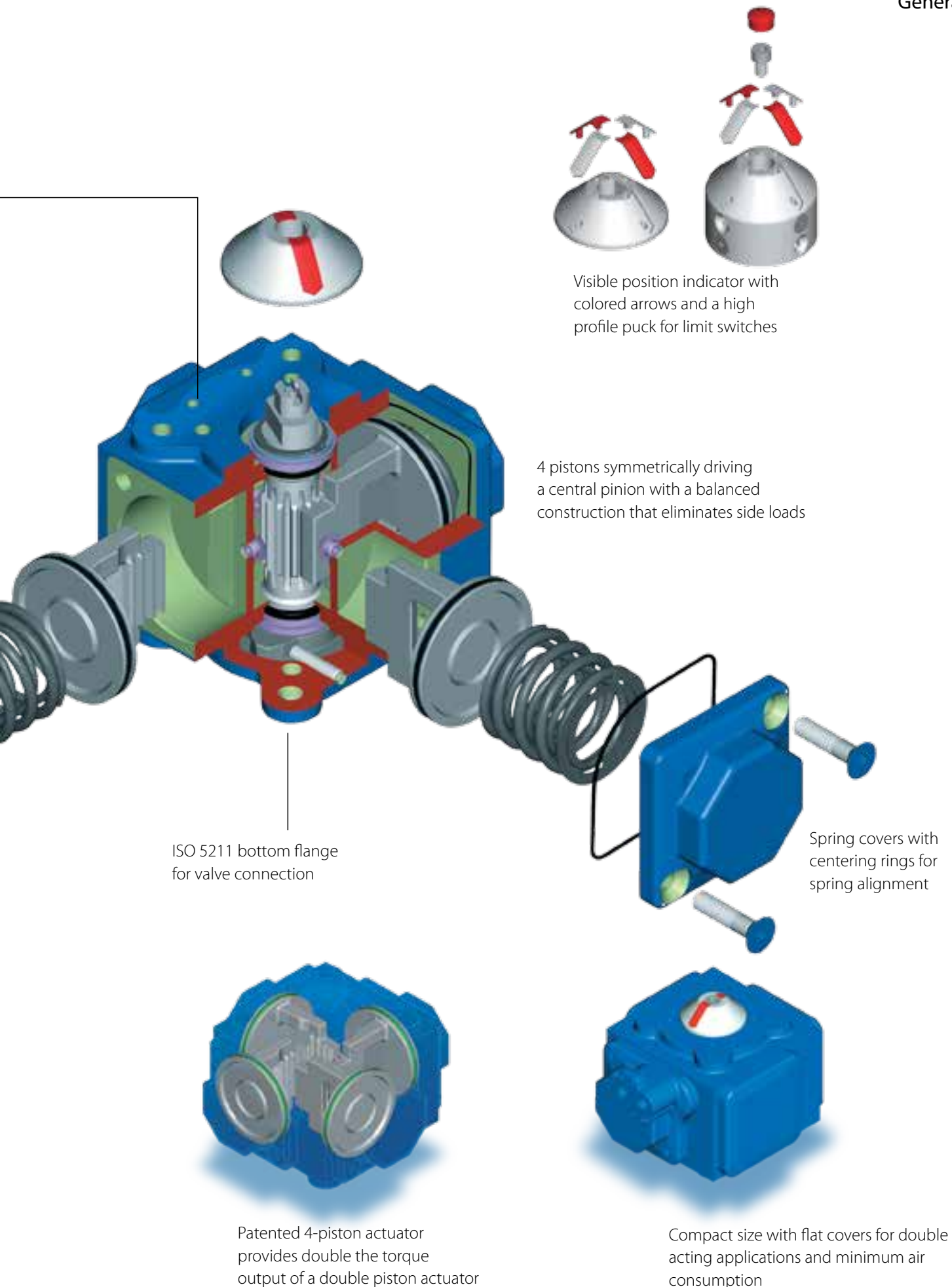

Visible position indicator with colored arrows and a high profile puck for limit switches

4 pistons symmetrically driving a central pinion with a balanced construction that eliminates side loads

ISO 5211 bottom flange for valve connection

Spring covers with centering rings for spring alignment

Patented 4-piston actuator provides double the torque output of a double piston actuator

Compact size with flat covers for double acting applications and minimum air consumption

Pneumatic actuator

General

COMPACT™
actuator

ESD system

Interfaces

Ordering
code system

Actuator dimensions

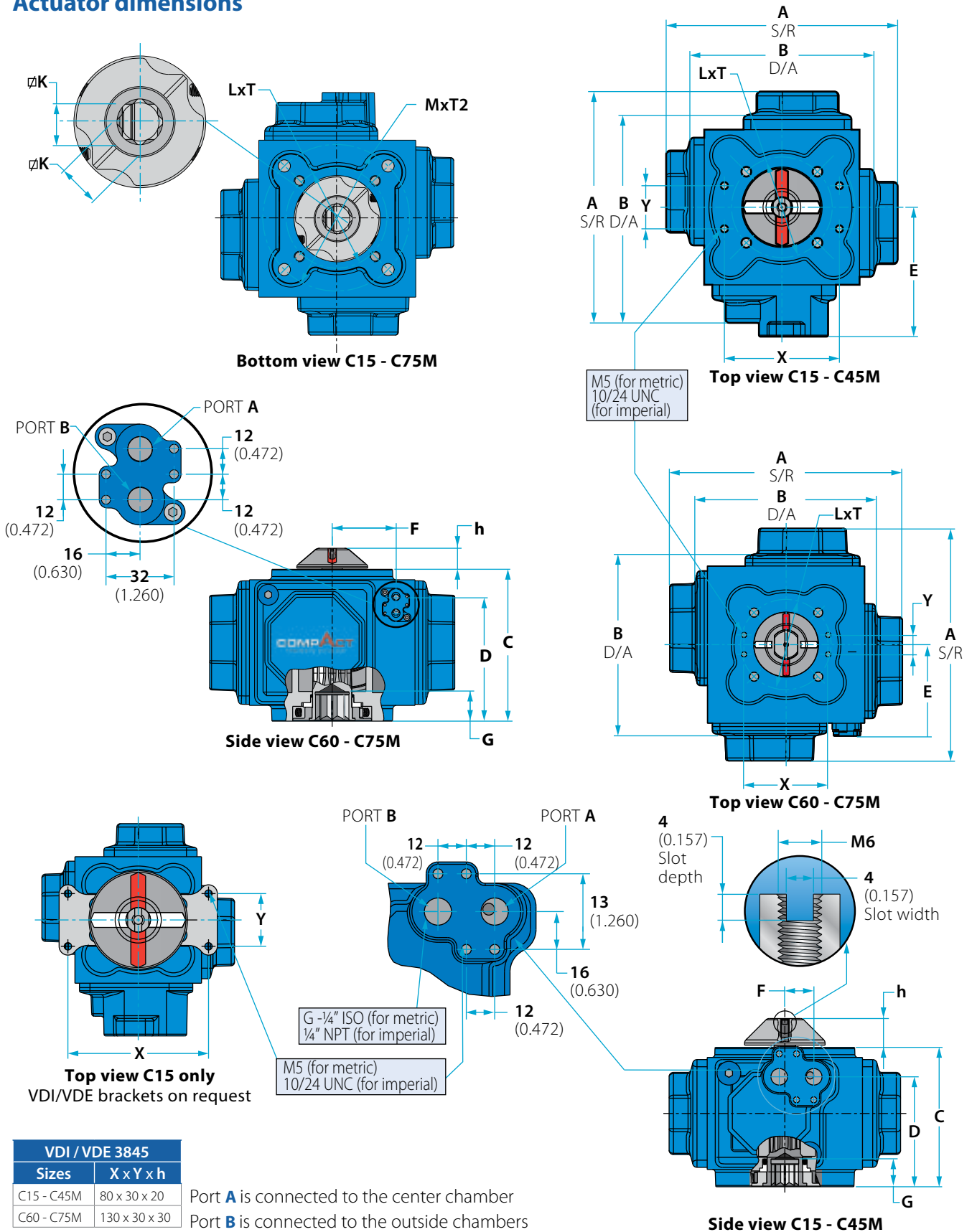

VDI / VDE 3845	
Sizes	X x Y x h
C15 - C45M	80 x 30 x 20
C60 - C75M	130 x 30 x 30

Port **A** is connected to the center chamber
 Port **B** is connected to the outside chambers

Size	A S/R		B D/A		B1 D/A		C		D		E		F		G		Øk		L PCD		T Thread		M PCD (2)		T2	
	mm	inch	mm	inch	mm	inch	mm	inch	mm	inch	mm	inch	mm	inch	mm	inch	mm	inch	mm	inch	mm	inch	mm	inch	mm	inch
C15	110	4.31	86	3.39	97.8	3.85	68.8	2.71	50.8	2.00	66.0	2.60	16.0	0.63	13.5	0.53	9	0.35	50 (F05)	1.97 (F05)	M6x8	1/4"X0.314	-	-	-	-
C20	131	5.17	102	4.03	117.0	4.60	80.5	3.17	61.5	2.42	77.2	3.04	16.5	0.65	15.0	0.59	11	0.43	50 (F05)	1.97 (F05)	M6x8	1/4"X0.314	70 (F07)	2.76 (F07)	M8x11	5/16"X0.43
C25	161	6.34	132	5.24	147.0	5.79	97.0	3.82	76.5	3.01	90.0	3.54	20.0	0.79	19.5	0.77	14	0.55	70 (F07)	2.76 (F07)	M8x9	5/16"X0.354	102 (F10)	4.02 (F10)	M10X11	3/8"X0.43
C30	186	7.33	151	5.94	169.0	6.64	116.0	4.58	93.4	3.68	105.0	4.15	22.3	0.88	22.0	0.87	17	0.67	70 (F07)	2.76 (F07)	M8x11	5/16"X0.43	102 (F10)	4.02 (F10)	M10X12	3/8"X0.47
C30M	216	8.50	-	-	-	-	116.0	4.58	93.4	3.68	120.0	4.72	22.3	0.88	22.0	0.87	17	0.67	70 (F07)	2.76 (F07)	M8x11	5/16"X0.43	102 (F10)	4.02 (F10)	M10X12	3/8"X0.47
C35	222	8.74	182	7.15	202.0	7.94	135.0	5.31	102.0	4.02	114.0	4.48	22.5	0.89	26.0	1.02	22	0.87	102 (F10)	4.02 (F10)	M10x13	3/8"X0.51	-	-	-	-
C35M	256	10.07	-	-	-	-	135.0	5.31	102.0	4.02	131.0	5.15	22.5	0.89	26.0	1.02	22	0.87	102 (F10)	4.02 (F10)	M10x13	3/8"X0.51	-	-	-	-
C45	269	10.59	221	8.70	245.0	9.65	164.0	6.46	127.0	5.00	147.0	5.79	31.0	1.22	33.0	1.30	27	1.06	125 (F12)	4.92 (F12)	M12x15	1/2"X0.59	102* (F10)	4.02* (F10)	M10X15	3/8"X0.59
C45M	303	11.93	-	-	-	-	164.0	6.46	127.0	5.00	164.0	6.45	31.0	1.22	33.0	1.30	27	1.06	125 (F12)	4.92 (F12)	M12x15	1/2"X0.59	102* (F10)	4.02* (F10)	M10X15	3/8"X0.59
C60	360	14.17	285	11.22	-	-	218.0	8.58	180.0	7.09	141.0	5.57	94.0	3.70	43.0	1.69	36	1.42	140 (F14)	5.51 (F14)	M16x18	5/8"X0.71	-	-	-	-
C60M	390	15.35	-	-	-	-	218.0	8.58	180.0	7.09	141.0	5.57	94.0	3.70	43.0	1.69	36	1.42	140 (F14)	5.51 (F14)	M16x18	5/8"X0.71	-	-	-	-
C75	437	17.20	342	13.46	-	-	270.0	10.63	223.0	8.76	166.0	6.54	110.0	4.33	43.0	1.69	36	1.42	140 (F14)	5.51 (F14)	M16x18	5/8"X0.71	-	-	-	-
C75M	467	18.38	-	-	-	-	270.0	10.63	223.0	8.76	166.0	6.54	110.0	4.33	43.0	1.69	36	1.42	140 (F14)	5.51 (F14)	M16x18	5/8"X0.71	-	-	-	-

* The C45 bottom PCD can be either F12 or F10, but not both. The standard is F12. When ordering C45 with F10, you must add it to the code.

Technical Data

Actuator size		Unit	C15	C20	C25	C30	C30M	C35	C35M	C45	C45M	C60	C60M	C75	C75M
Weight		kg	1.10	1.90	3.50	5.00	6.10	9.00	10.40	15.00	16.70	35.00	39.40	64.00	72.00
Spring return		lb	2.40	4.20	7.70	11.00	13.40	19.80	22.00	33.10	37.40	77.20	86.00	141.10	158.00
Weight		kg	0.90	1.50	2.60	4.40	-	7.10	-	11.00	-	26.00	-	51.00	-
Double acting		lb	1.98	3.30	62.00	9.70	-	15.70	-	24.30	-	57.30	-	112.40	-
Air consumption per stroke actual volume	CCW	liter	0.07	0.12	0.25	0.44	0.44	0.74	0.74	1.33	1.33	3.20	3.2	5.76	5.76
	CW		0.09	0.15	0.33	0.54	-	0.80	-	1.33	-	3.20	-	5.76	-
	Total		0.16	0.27	0.58	0.98	-	1.54	-	2.66	-	6.40	-	11.52	-
Air consumption per stroke actual volume	CCW	in ³	4.30	7.30	15.00	27.00	27.00	45.00	45.00	81.00	81.00	195.00	195	351.00	351.00
	CW		5.50	9.20	20.00	33.00	-	49.00	-	81.00	-	195.00	-	351.00	-
	Total		9.80	16.50	35.00	60.00	-	94.00	-	162.00	-	391.00	-	703.00	-
Stroke time with S.V. with 0.9 Cv at 80 psi	D/A	sec.	0.10	0.13	0.20	0.24	-	0.40	-	0.75	-	1.50	-	2.50	-
	S/R Open		0.10	0.15	0.23	0.29	0.30	0.54	0.60	1.00	1.10	2.20	2.4	3.70	4.00
	S/R Close		0.15	0.15	0.23	0.28	0.28	0.48	0.50	0.77	0.80	1.60	1.6	2.90	2.90

Actuator components & materials

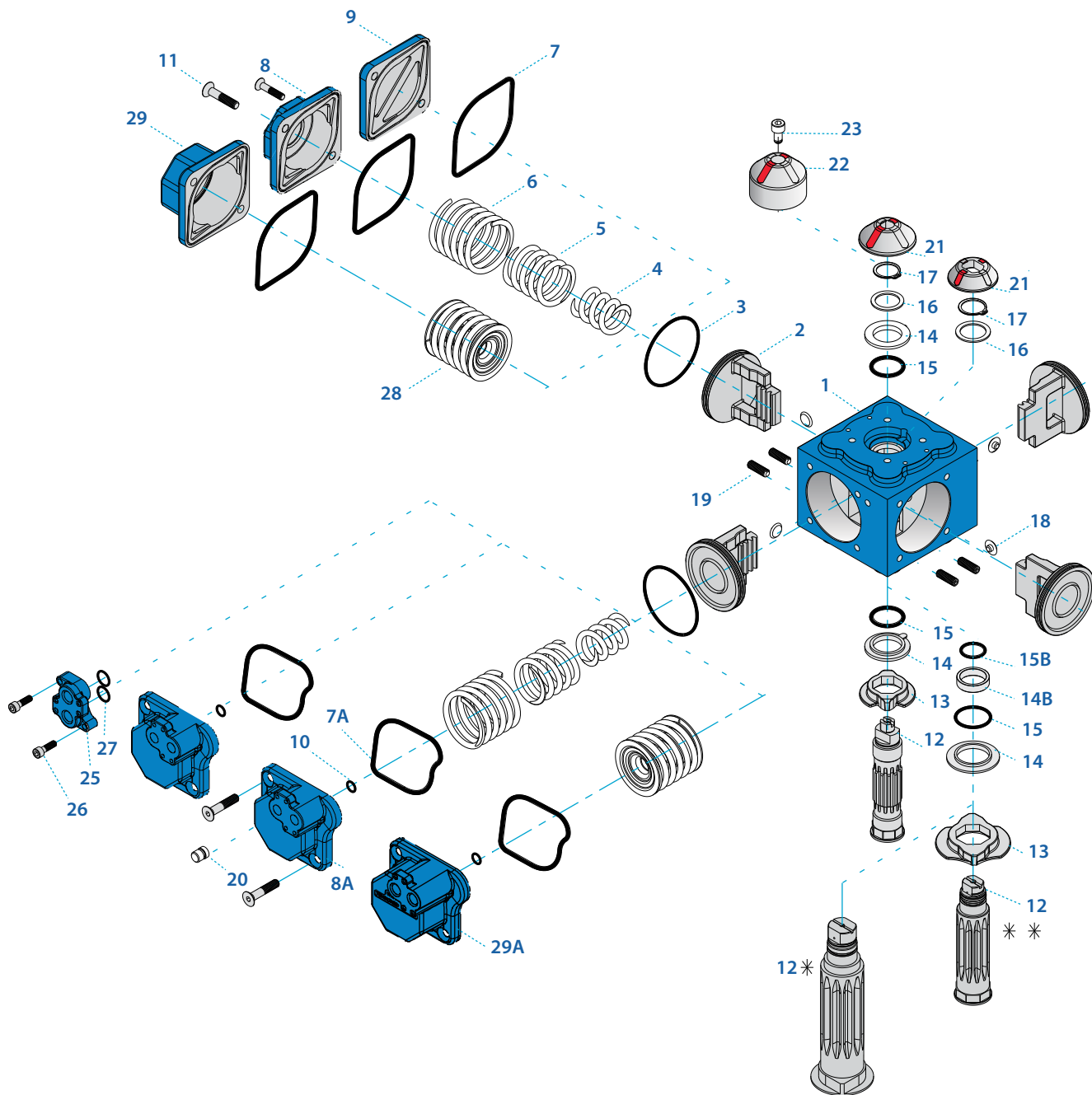

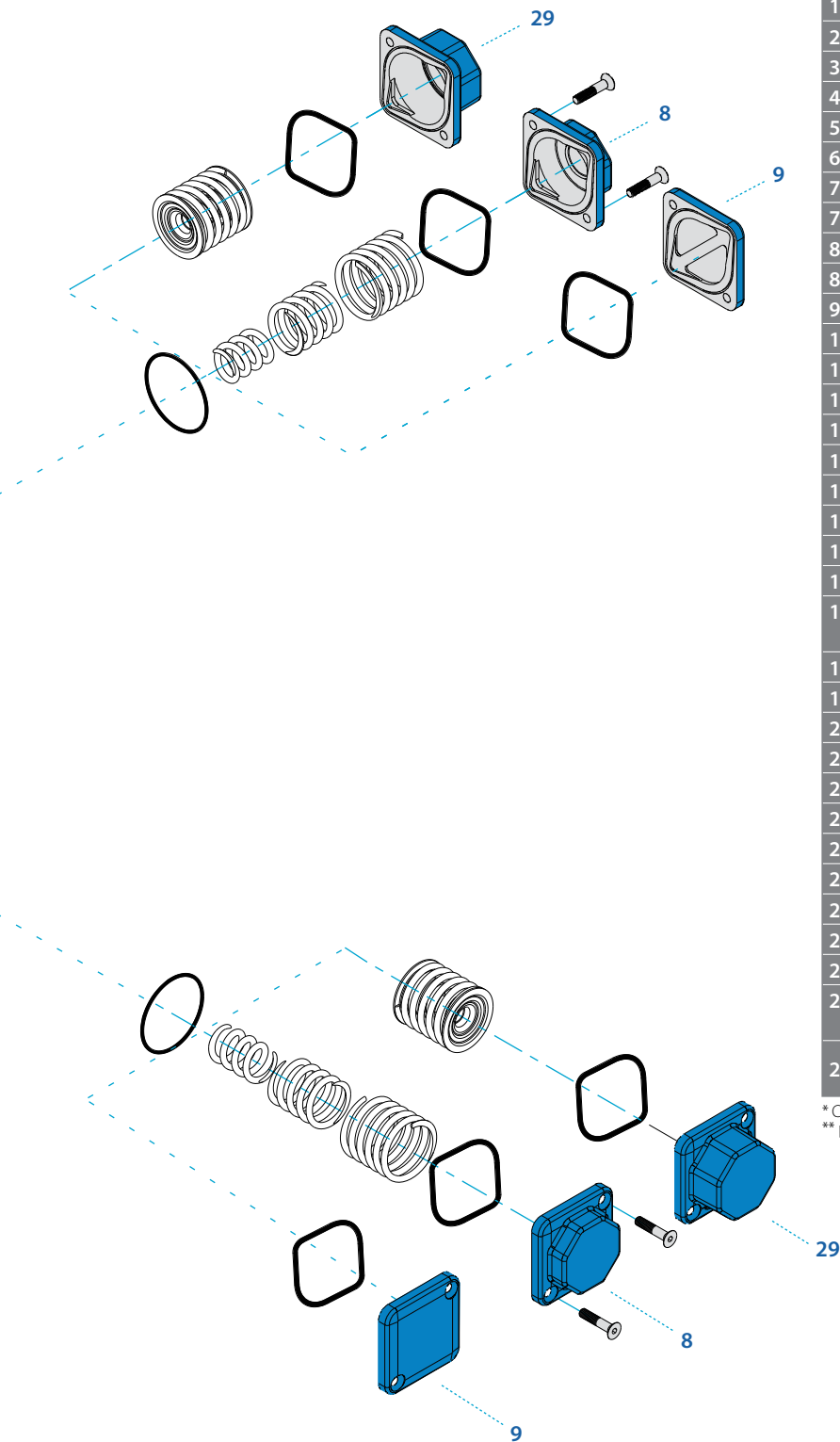

Item	Description	Material specifications	Qty.
1	Body	AL 356-T6	1
2	Piston	AL 356/380	4
3	Piston O-ring	NBR, Viton, EPDM, NBR FX428	4
4	Inner spring	Spring steel, painted	4
5	Middle spring	Spring steel, painted	4
6	Outer spring	Spring steel, painted	4
7	Cover O-ring	NBR, Viton, EPDM, NBR FX428	3
7a	NAMUR cover O-ring	NBR, Viton, EPDM, NBR FX428	1
8	Spring return cover	AL 380	3
8a	NAMUR cover	AL 380	1
9	Double acting cover	AL 380	3
10	Air supply O-ring	NBR, Viton, EPDM, NBR FX428	1
11	Cover screw	Stainless steel	8-16
12	Pinion	Steel ENP	1
13	Stop plate	Stainless steel CF8M	1
14	Thrust washer	Delrin, CF PTFE, UHMWPE	2
14B	Bearing	Delrin, CF PTFE, UHMWPE	1
15	Pinion O-ring	NBR, Viton, EPDM, NBR FX428	2
15B	Top pinion O-ring	NBR, Viton, EPDM, NBR FX428	1
16	Disc bearing	Stainless steel / Delrin	1
17	Circlip	Stainless steel, spring steel zinc plated	1
18	Pad	Delrin, CF PTFE, UHMWPE	4
19	Stroke adjustment screw	Stainless steel	4
20	Exhaust plug (silencer)	Delrin, brass	1
21	Indicator	Plastic ABS, red & white	1
22	Puck	Plastic ABS, red & white	1
23	Indicator screw	Stainless steel	1
24	Tag (not shown)	Stainless steel	4
25	NAMUR insert	AL 380	1
26	Insert screw	Stainless steel	2
27	NAMUR insert O-ring	NBR, Viton, EPDM, NBR FX428	2
28	Spring cassette	Spring steel, painted	4
29	Spring return cover for M series	AL 380	3
29A	NAMUR cover for M series	AL 380	1

* C75 & C75M Pinion (12) and stop (13) are one pcs
 ** pinion assembly for actuators C35 and above

Pneumatic actuator

General

COMPACT™
actuator

ESD system

Interfaces

Ordering
code system

Torque chart (Nm)

Double acting

Size	Operating pressure (bar)						
	3.0	4.0	5.0	5.5	6.0	7.0	8.0
C15	10	14	17	19	21	24	27
C20	18	25	32	35	38	45	51
C25	39	52	65	72	79	92	105
C30	62	84	107	119	130	153	176
C35	114	151	190	208	226	265	304
C45	222	297	371	408	445	519	593
C60	527	703	879	967	1,055	1,230	1,406
C75	974	1,299	1,624	1,786	1,948	2,273	2,596

Spring return single acting

Size	Spring set	Air pressure - bar (psi)														Spring torque	
		3.0 (44)		4 (58)		5 (73)		5.5 (80)		6 (87)		7 (102)		8 (116)		Start	End
		Start	End	Start	End	Start	End	Start	End	Start	End	Start	End	Start	End		
C15	1A	7	4	10	7	13	11	15	12	17	14	20	17	24	21	6	3
	1B			8	4	12	8	13	10	15	11	18	14	22	18	9	5
	1B2					10	5	12	7	13	9	16	11	20	15	12	7
C20	2									11	6	14	8.5	18	12	15	9
	2A			16	10	22	16	26	19	29	22	35	29	41	35	15	9
	2A2B			14	7	20	13	24	16	27	19	33	26	39	32	18	11
	2B					18	10	22	13	25	17	31	23	38	29	21	13
	2C							19	10	22	13	28	19	35	25	25	16
C25	3							19	9	24	15	30	21	29	19	19	
	2A	23	11	36	23	49	36	55	42	62	49	75	62	88	74	28	16
	2A2B			33	19	46	32	53	39	60	45	73	58	86	70	32	18
	2B					43	27	50	34	57	41	70	53	83	66	36	21
	2C					38	18	45	24	52	31	64	44	77	56	47	27
C30	3							47	21	60	34	73	46	57	31		
	2A	36	19	57	40	80	62	91	73	102	84	125	107	148	129	42	26
	2A2B			52	30	75	52	86	63	98	74	120	96	143	118	53	31
	2B			48	18	70	43	81	54	93	65	115	87	138	109	62	36
	2C					64	25	73	39	85	50	107	72	130	94	78	44
C35	3							75	33	98	55	120	77	96	54		
	2A	27	19	48	40	70	62	81	73	92	84	113	106	135	128	42	34
	2A2B	21	12	42	33	64	55	75	67	85	77	107	99	129	121	49	40
	2B			36	26	57	48	69	60	79	70	101	92	123	114	56	46
	2C					48	36	59	47	69	58	91	82	113	102	69	57
C35M	3							58	44	80	66	102	88	83	68		
	2A	75	39	111	74	150	112	168	129	186	147	224	184	262	221	74	38
	2A2B	64	26	100	62	139	99	157	117	175	134	213	171	251	208	87	49
	2B			92	44	130	82	148	99	166	117	204	154	242	191	105	58
	2C							133	68	151	86	189	123	227	160	137	73
C45	3							135	63	173	100	211	137	161	89		
	2A	54	42	89	77	126	114	143	131	160	148	197	185	234	223	70	57
	2A2B	43	28	78	63	115	110	132	117	149	134	186	171	223	209	85	69
	2B			67	49	104	86	121	103	139	120	176	157	213	195	99	80
	2C					86	65	103	82	120	99	157	136	194	173	122	100
C45M	3							102	76	139	114	176	151	146	119		
	2A	134	60	208	132	280	203	317	239	353	275	426	346	499	417	159	86
	2A2B			197	113	269	184	306	219	342	255	415	326	488	397	179	97
	2B			179	82	252	153	288	188	325	224	398	295	471	366	212	115
	2C					223	102	260	137	296	173	369	244	442	315	265	144
C60	3							268	122	341	193	414	264	318	173		
	2A	90	60	162	131	232	201	267	236	302	271	373	342	443	412	134	107
	2A2B	110	83	181	154	251	225	286	260	321	295	392	365	462	436	160	127
	2B			142	107	213	177	248	213	283	248	353	318	424	388	184	147
	2C					180	136	215	171	250	206	321	277	391	347	228	182
C60M	3							216	163	286	234	357	304	273	218		
	2A	328	160	501	329	675	498	762	583	848	667	1021	835	1194	1004	360	194
	2A2B			478	285	651	454	738	538	824	623	997	791	1170	960	406	218
	2B			442	221	615	390	702	475	789	559	961	727	1134	896	473	254
	2C					548	268	635	352	721	437	894	605	1067	774	600	323
C75	3							657	322	830	490	1003	659	720	388		
	2A	212	148	379	315	546	483	630	566	714	650	880	816	1047	983	371	304
	2A2B	259	203	426	370	593	537	677	621	760	704	927	871	1094	1038	314	255
	2B			333	261	500	428	583	512	667	595	833	762	1000	929	429	353
	2C					411	321	495	404	578	488	744	654	912	821	542	447
C75M	3							502	393	668	559	835	726	642	527		
	2A	614	345	935	657	1255	969	1414	1124	1574	1280	1894	1592	2212	1902	615	350
	2A2B			891	582	1211	894	1370	1049	1530	1205	1850	1517	2168	1827	693	395
	2B			820	461	1140	773	1299	928	1459	1084	1779	1396	2097	1706	819	467
	2C					1025	576	1184	632	1344	887	1664	1199	1982	1509	1024	584

Torque chart (in-lb)

Double acting

Size	Operating pressure (psi)						
	40	60	70	80	90	100	120
C15	81	125	149	172	188	207	244
C20	146	229	271	311	351	390	468
C25	317	476	555	639	723	802	961
C30	505	769	914	1,052	1,190	1,334	1,611
C35	928	1,382	1,624	1,848	2,073	2,311	2,780
C45	1,807	2,719	3,170	3,622	4,074	4,525	5,429
C60	4,289	6,436	7,511	8,585	9,659	10,725	12,872
C75	7,926	11,893	13,877	15,856	17,834	19,819	23,767

Spring return single acting

Size	Spring set	Air pressure - psi (bar)														Spring torque	
		40 (2.8)		60 (4.1)		70 (4.8)		80 (5.5)		90 (6.2)		100 (6.9)		120 (8.3)			
		Start	End	Start	End	Start	End	Start	End	Start	End	Start	End	Start	End	Start	End
C15	1A	56	32	92	64	110	93	133	106	156	128	174	148	220	192	53	27
	1B			73	37	102	68	115	89	137	101	156	121	201	165	80	44
	1B2					85	42	106	62	119	82	139	95	183	137	106	62
	2									101	55	121	74	165	110	133	80
C20	2A			146	92	187	136	230	168	266	201	304	252	375	320	133	80
	2A2B			128	64	170	110	212	142	247	174	286	226	357	293	159	97
	2B					153	85	195	115	229	156	269	200	348	266	186	115
	2C							168	89	201	119	243	165	320	229	221	142
C25	2A	185	89	330	211	416	306	487	372	568	449	651	538	806	677	248	142
	2A2B			302	174	390	272	469	345	549	412	633	503	787	641	283	159
	2B					365	229	443	301	522	375	607	460	760	604	319	186
	2C					322	153	398	212	476	284	555	382	705	513	416	239
C30	2A	290	153	522	366	679	526	805	646	934	769	1085	928	1355	1181	372	230
	2A2B			476	275	636	441	761	558	897	677	1041	833	1309	1080	469	274
	2B			439	165	594	365	717	478	851	595	998	755	1263	998	549	319
	2C					543	212	646	345	778	458	928	625	1190	861	690	389
C30M	2A	217	153	439	366	594	526	717	646	842	769	980	920	1236	1172	372	301
	2A2B	169	97	385	302	543	467	664	593	778	705	928	859	1181	1108	434	354
	2B			330	238	484	407	611	531	723	641	876	798	1126	1044	496	407
	2C					407	306	522	416	632	531	790	694	1035	934	611	504
C35	2A	603	314	1016	677	1273	950	1487	1142	1703	1346	1944	1596	2399	2023	655	336
	2A2B	515	209	916	568	1180	840	1389	1035	1602	1227	1848	1484	2298	1904	770	434
	2B			842	403	1103	696	1310	876	1520	1071	1770	1336	2216	1749	929	513
	2C							1177	602	1382	787	1640	1067	2078	1465	1212	646
C35M	2A	434	338	815	705	1069	967	1266	1159	1465	1355	1709	1605	2142	2042	620	504
	2A2B	346	225	714	577	976	933	1168	1035	1364	1227	1614	1484	2042	1913	752	611
	2B			613	449	883	730	1071	912	1273	1099	1527	1362	1950	1785	876	708
	2C					730	552	912	726	1099	906	1362	1180	1776	1584	1080	885
C45	2A	1078	483	1904	1208	2376	1723	2805	2115	3232	2518	3696	3002	4568	3818	1407	761
	2A2B			1804	1035	2283	1561	2708	1938	3131	2335	3601	2829	4468	3635	1584	858
	2B			1639	751	2139	1298	2549	1664	2975	2051	3453	2560	4312	3351	1876	1018
	2C					1892	866	2301	1212	2710	1584	3202	2117	4047	2884	2345	1274
C45M	2A	724	483	1483	1199	1969	1706	2363	2089	2765	2481	3236	2967	4056	3772	1186	947
	2A2B	885	668	1657	1410	2130	1909	2531	2301	2939	2701	3401	3167	4230	3992	1416	1124
	2B			1300	980	1808	1502	2195	1885	2591	2270	3063	2759	3882	3552	1628	1301
	2C					1528	1154	1903	1513	2289	1886	2785	2403	3580	3177	2018	1611
C60	2A	2639	1287	4587	3012	5728	4226	6744	5160	7764	6107	8859	7245	10931	9192	3186	1717
	2A2B			4376	2609	5525	3853	6531	4761	7544	5704	8650	6863	10712	8789	3593	1929
	2B			4047	2023	5219	3310	6213	4204	7223	5118	8338	6308	10382	8203	4186	2248
	2C					4650	2274	5620	3115	6601	4001	7757	5249	9769	7086	5310	2859
C60M	2A	1706	1191	3470	2884	4634	4099	5576	5009	6537	5951	7635	7080	9585	9000	3283	2690
	2A2B	2084	1633	3900	3387	5032	4557	5991	5496	6958	6445	8043	7557	10016	9503	2779	2257
	2B			3049	2390	4243	3632	5160	4531	6107	5447	7228	6611	9155	8505	3797	3124
	2C					3488	2724	4381	3575	5292	4468	6455	5674	8350	7516	4797	3956
C75	2A	4940	2776	8560	6015	10650	8223	12514	9947	14410	11719	16433	13813	20251	17413	5443	3098
	2A2B			8157	5328	10277	7587	12125	9284	14007	11032	16051	13162	19848	16727	6133	3496
	2B			7507	4221	9674	6560	11496	8213	13357	9924	15435	12112	19198	15619	7248	4133
	2C					8698	4888	10478	5593	12305	8121	14438	10403	18146	13815	9062	5168
C75M	2A	3862	2896	7223	6116	9318	8291	11080	10009	12872	11764	14871	13830	18503	17395	5275	4142
	2A2B	3266	2164	6546	5292	8690	7527	10416	9213	12186	10940	14229	13041	17825	16571	6115	4841
	2B			5868	4468	8054	6764	9762	8416	11508	10107	13587	12260	17148	15747	6956	5522
	2C					6781	5143	8434	6726	10135	8359	12277	10603	15765	13998	8726	6930
3									8780	6647	11002	8980	14419	12286	10478	8301	

Emergency Shut-Down system (ESD)

Short response time

A short response time is essential for valves operating in Emergency Shut Down (ESD) systems such as in refineries, power stations, mining and other applications where Safety Integrity Level (SIL) loops are a mandatory requirement. The values in the table below indicate the closing time (seconds) of an unloaded actuator and a loaded actuator with torque values simulating real-life situations. The stroke time measures the actual movement of the actuator without a solenoid or any other accessory delay.

COMPACT actuator stroking time (sec.)

1/4" NAMUR solenoid valve

COMPACT Actuator for emergency Shut-down (ESD) systems		1/4" NAMUR solenoid valve Cv = 0.9, 80 Psi instrument air pressure feed by 6 mm I.D. pipe			1/4" Non- NAMUR solenoid valve, Cv = 1, 80 Psi Instrument air pressure feed by 6 mm I.D. pipe + 1/4" quick exhaust		
		Basic design		Basic design + Breather Block			
		Solenoid configuration					
Size	Load	3/2	5/2	3/2	3/2	3/2	
C20-2C	0	0.09	0.08	0.05		0.05	
	10 Nm / 89 in-lb	0.14	0.09	0.07		0.07	
C25-2C	0	0.17	0.12	0.07		0.06	
	22 Nm / 195 in-lb	0.35	0.15	0.17		0.15	
C30-2C	0	0.26	0.20	0.12		0.10	
	36 Nm / 319 in-lb	0.49	0.23	0.25		0.20	
C35-2C	0	0.39	0.29	0.26		0.17	
	60 Nm / 531 in-lb	0.58	0.35	0.41		0.27	
C45-2C	0	0.71	0.52	0.43		0.30	
	116 Nm / 1027 in-lb	1.23	0.64	0.76		0.57	
C60-2C	0	1.79	1.30	1.21		0.73	
	260 Nm / 2300 in-lb	2.36	1.38	1.73		1.13	
C75-2C	0	2.78	2.00	1.86		1.08	
	460 Nm / 4071 in-lb	3.90	2.42	2.91		1.75	

1/2" Non-NAMUR solenoid valve

COMPACT Actuator for Emergency Shut-Down (ESD) systems		1/2" Non-NAMUR solenoid valve Cv = 3.5, 80 Psi instrument air pressure feed by 9.5 mm I.D. pipe			1/2" Non- NAMUR solenoid valve, Cv = 3.5, 80 Psi Instrument air pressure feed by 9.5 mm I.D. pipe + 1/2" quick exhaust		
		Basic design		Basic design + Breather Block			
		Solenoid configuration					
Size	Load	3/2	5/2	3/2	3/2	3/2	
C60-2C	0	0.71	0.49	0.99		0.53	
	260 Nm / 2300 in-lb	1.22	0.60	1.50		0.80	
C75-2C	0	1.12	-	-		1.04	
	460 Nm / 4071 in-lb	1.79	-	-		1.52	

NAMUR & ISO interface

An extensive range of accessories such as solenoids, positioners and limit switches are available for direct mounting to the COMPACT actuator. Any accessory whose connections comply with ISO 5211 and VDI/VDE 3845 (NAMUR) mounting can be connected to the actuator.

NAMUR VDI/VDE 3845

This standard provides for a range of accessories such as limit switches, pucks, indicators and positioners with a VDI/VDE interface so that they can be easily mounted onto the actuator top face.

NAMUR solenoid mounting

One of the four available actuator covers incorporates a pad for solenoid mounting according to the NAMUR international standard. Any solenoid that conforms to the NAMUR interface can be directly mounted to the actuators, thus simplifying the installation of solenoids and eliminating additional piping. It also allows quick actuation response as pressurized air supply is available at the port entrance.

ISO 5211

The actuator bottom flange is in accordance with the ISO 5211 international standard and incorporates a star-shaped female drive to flexibly fit a variety of valve output shafts. The valve can be attached by a bracket or mounted directly onto the actuator, using one of the various ISO hole patterns.

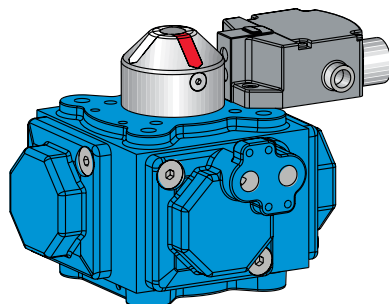
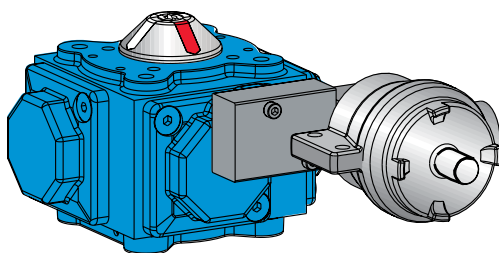
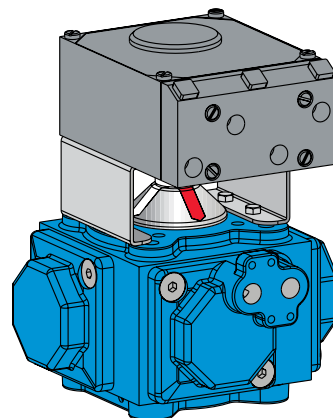
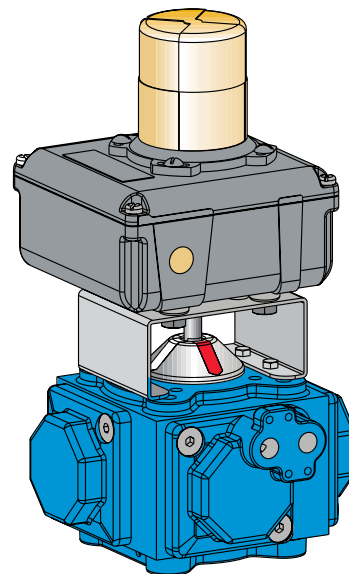

Actuation

Pneumatic actuator

General

COMPACT™
actuator

ESD system

Interfaces

Ordering
code system

Ordering code system

The HABONIM COMPACT identification code

Size	Type		Springs set			Threads		Indicator	
C15	SR	Spring return	C15	C20 to C75M		I	Imperial	Default standard white with red arrows	
C20	DA	Double acting	1A	2AB	2A3			D	Red with white arrows
C25			1B	2A	2C			P	High profile
C30			1B2	2A2B	2C3			Flow	
C30M			2	2B	3			Default straight	
C35			For more details of spring set combinations, see page 7					T	3-Way
C35M								L	2-Way 90 deg
C45								Options	
C45M								V	Viton O-rings
C60								E	EPDM O-rings
C60M								N	Electroless nickel plating
C75								U	UHMWPE
C75M								LT	FX428 special NBR compound for low temperature
								RFS	Reverse fail safe for CCW rotation

Examples:

C35 SR 2C-N Size C35, spring return, 2C spring set, metric thread, standard indicator, electroless nickel coating.

C60 DA I-DT-LT Size C60, double acting, imperial thread, indicator red with white arrows, flow 3-way, FX428 O-rings.

In some applications the options described above are limited to specific sizes. Consult with Habonim for details.

Flow directions

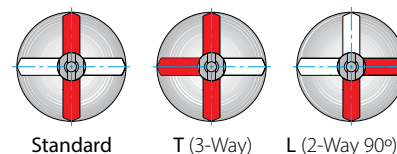

In accordance with our policy to strive for continuous improvement of the product, we reserve the right to alter the dimensions, technical data and information included in this catalog when required.



www.habonim.com

ISRAEL
Habonim Headquarter
Tel: +972-4-6914911
Fax: +972-4-6914935
sales_international@habonim.com

UK
Habonim UK
Tel: +44-1633-484554
Fax: +44-1633-482252
sales_uk@habonim.com

USA
Habonim USA
Toll Free Phone: 1-866-261-8400
Toll Free Fax: 1-866-243-9959
sales_usa@habonim.com

China
Habonim China
Tel: + 86 21 64453190 *146
Fax: + 86 21 64453191
sales_china@habonim.com

Australia
Habonim Australia
Tel: +61 3 9556 5428
sales_au@habonimau.com



www.habonim.com



Pneumatic Actuator Cat.

MAXMARK CAT-ACT-MAIN 01/16



RUGVÆNGET 19 C
2630 TAASTRUP
INFO@PGFLOWTEKNIK.DK
WWW.PGFLOWTEKNIK.DK

