

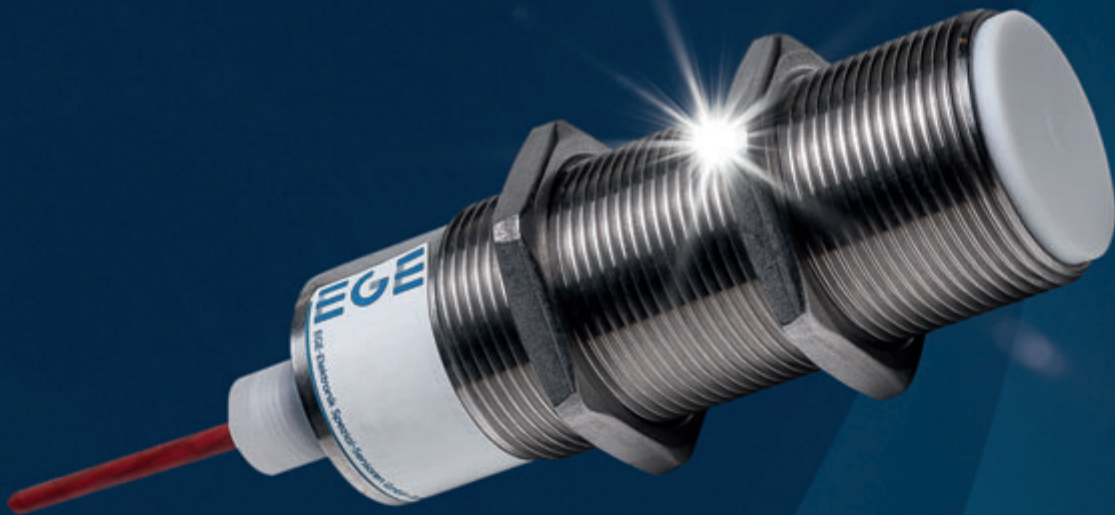

Inductive Sensors



Special-Sensors for Automation

Inductive Sensors

Contents

Technique and application for Inductive Sensors

Application notes	3.3
Terminology for inductive measurement	3.4 - 3.6

Extreme environment

Metal face sensors Series IGV / IGVU...-C / IGWV	3.8 - 3.11
Mounting clamp for metal face sensors Series KBM	3.12
POLAR-Series climatic-proofed -60 °C Series IGMP / -80 °C Series IGMP	3.13 - 3.15
TROPICAL-Series climatic proofed 120 °C Series IGMF / IGMW	3.16 - 3.21
TROPICAL-Series resistant to cooling fluids 120 °C Series IGFW / INFW	3.22 - 3.23
TROPICAL-Series resistant to cooling fluids armoured cable Series IGMF / INFW	3.24 - 3.25
High temperature 120 °C Series IGMT / Series IDT	3.26 - 3.28
High temperature 160 °C Series IGMH	3.29 - 3.30
High temperature 250 °C Series IGH / IRH / IDH	3.31 - 3.32
High temperature 200 °C Series INT	3.33
Amplifiers for high temperature sensors Series IKM / IU	3.34 - 3.35

Demanding environment

Metal sleeve M12 / M18 / M30 Series IGM	3.36 - 3.39
Long sensing range Ø 80 mm / Ø 105 mm / Ø 160 mm / Ø 200 mm Series ID	3.40 - 3.43

Analogserie

Metal sleeve M12 / M18 / Series IGA	3.44 - 3.45
Long sensing range Ø 80 mm Series IDA	3.45
High temperature 160 °C Series IGT	3.46

Standard switches

Metal sleeve M12 / M18 / M30 Series IGM	3.47 - 3.48
Smooth-bodied switches Ø 20 mm / Ø 34 mm Series INK	3.49

Special functions

Surface sensors Series IFE	3.50
Offshore Series IGMO / Series IGVO	3.51 - 3.52
Washing resistant Series IDKW	3.53
Factor 1 Series IGB / IDB	3.54
Speed sensor Series HGVH	3.55

Inductive Sensors for Ex-applications

Dust / Gas-Ex compact model Zone 0/20 Series IGEX20a / IGEX20Pa	3.58 - 3.59
Dust / Gas-Ex intrinsically safe Zone 0/20 Series IGEXUa / IGEXa	3.60 - 3.61
Dust / Gas-Ex intrinsically safe Zone 0/20 Series IGEXHa	3.62
Dust / Gas-Ex intrinsically safe Zone 0/20 Series IGEXPa	3.63
Dust / Gas-Ex compact model 2/22 Series IGEX22c / IGVEX22c	3.64 - 3.66
Ex-Amplifiers Series IKMb 122 Ex / IKMb 123 Ex	3.67 - 3.68

Accessories

M12 connector	3.69
PG plug system	3.70
Assembly parts	3.71

Technical alterations are reserved to us without prior announcement. The information provided in this catalogue is for reference only. Product installation information can be found in the instructions supplied with each product.

Inductive Sensors

Application notes

Sensors

Page 3.08–3.11

Metal face sensors

The inductive proximity switches series IGV are used in areas with heavy-duty mechanical loads at the sensor's face or where seals between face and housing cannot be used. Chips hitting the front or frequently changing coolants or lubricants do not diminish the function of these proximity switches. The variants with a PTFE coating are particularly well-suited for welding lines and similar environments where sensors are exposed to heavy soiling. Metal face switches are manufactured from stainless steel and are one solid piece. They detect iron and steel through the metal front face.

Page 3.13–3.15

POLAR-Switches

The POLAR-switch is ideal for application in cold storage houses and in extreme climate conditions. It is water-proof, safe for cleaning and extremely chemical-resistant. Because of its stainless steel housing, it can withstand vibrations on vehicles. The POLAR-switch is very compact and robust, it can be used from -60 °C to $+60\text{ °C}$. IGMP 030 S-80 sensors are suitable in cryogenic processes and for medical-technical applications; they can be used for temperatures up to -80 °C .

Page 3.16–3.21

TROPICAL-Switches

The TROPICAL switches series IGMF are anticipated for applications in corrosive environment. They are stable particularly at frequent temperature changes and simultaneously high humidity. The permanent work in carwashes is permissible. The high corrosion resisting at simultaneously high mechanical loading capacity is reached through the combination of PTFE and titan stabilized stainless steel. The PTFE-hoods are sealed through fluoroelastomers O-rings surely. The FEP-connecting cable is poured within the housing and freed over a double seal from the housing. Cable lengths up to 100 m are available. The installed LED's are shining through the cable side cap and don't break out the case. IGMW series sensors are suitable for hydro steam environ-

ments with pressures of up to 4 bars. For higher pressures in hydro steam environments, IGWW series sensors made of full stainless steel are recommended.

Page 3.22–3.28

120 °C-High temperature switches

The inductive PTFE switches series IGFW and INFW are made entirely of PTFE. The housing cover is securely sealed with a fluoroelastomer O-Ring. These sensors are designed for particularly difficult and aggressive environmental conditions. They can be used in damp and aggressive environments as well as under water (oil). IGMT- and IDT-series proximity switches are designed for use in temperatures up to 120 °C .

Page 3.29–3.30

160 °C-High temperature switches

Inductive compact devices for ambient temperatures up to 160 °C are available flush and non-flush in the standard designs M12, M18 and M30 with switching distances from 2 mm to 15 mm. The material used is the rugged stainless steel housing combined with high temperature resistant PEEK plastic.

Page 3.31–3.32

250 °C-High temperature sensors

The inductive proximity switches series IGH/IDH/IRH are used for ambient temperatures up to 250 °C . The units feature optional a plug connection which withstands high temperatures, allowing users to quickly and easily install a replacement sensor head in case of damage without having to replace the sensor cable. The sensors are particularly suited for operation in extreme heat, e. g. in drying ovens or brick kilns. Manufactured from aluminum / stainless steel and PEEK, the robust sensors can be used in rugged industrial environments. Their electronics are housed separately in a plug-gable cable amplifier. The units are connected via a metal armored cable.

Page 3.34–3.35

Amplifiers

Switching amplifiers are designed for induction sensors for which it is necessary to separate the sensor coil from the amplifier, e. g. for operating tem-

peratures above 160 °C or for sensor coils which must be exchanged due to frequent damage. The switching amplifiers work statically, that is, if the sensor coil is permanently damped, the switching output also remains activated. Switching interval and hysteresis (IKM 120 GPP, IU 130...) can be set on the amplifier. The sensor cable may have a length of up to 20 m.

Page 3.36–3.43

Demanding environment

The "Demanding environment" series is especially designed for harsh environments in which sensors are subjected to high electrical, electromagnetic or mechanical stress. For sensors used in critical applications, EGE has developed special inspection and test methods which place particular emphasis on the disturbances that occur in various production environments. The sensors are designed to be very resistant to the interference spectra produced by, e. g., frequency inverters, wireless communication systems and switching power supplies.

Page 3.50

Surface sensors IFE...

The switches are built as flat sensors. They are used particularly to detect moving sheet metal or steel rods on conveyor belts. The complete sensor is covered, which make the sensor moisture resistant. Reduced overall height affects the operating distance (sn). The IFE switches are self-contained with integral amplifier.

Page 3.58–3.68

Dust- and Gas-Ex sensors

Series IGEXa..., IGEX20a... and IGEX22c... are sensors for detecting metals in the Ex area zone 0/20 and zone 2/22 according to ATEX and IECEx. Devices can be delivered in the standard configurations M12, M18 and M30. For extreme environment sensors are available for high and low temperatures (up to $+140\text{ °C}$ and down do -60 °C respectively), both in IP 68/IP 69.

Inductive Sensors

Technique & Application

Terminology

Operating principal

An inductive proximity switch works with a high frequency oscillating circuit that creates an alternating electromagnetic field on the active sensor surface by means of a coil. When a metallic object nears this field a damping occurs in the oscillating circuit. If this damping exceeds a threshold value, a switching signal is generated.

Operating distance

The operating distance is the distance between an object and the active sensor surface at which a switching signal is generated. The operating distance depends on the diameter of the coil. Therefore larger sensors are required for longer operating distances. On some of the EGE sensors the operating distance is adjustable.

If a metal object dampens only a part of the alternating field, the operating distance decreases; a larger object increases it. The following approximate values are derived from a standard rectangular measurement plate made of steel ST 37 with an edge length that corresponds to the diameter of the sensor coil or three times the rated operating distance, whichever is greater.

Damping area in %					
150	100	75	50	25	12,5
Operating distance in %					
110	100	93	86	73	55

The operating distance is influenced by the material of the object: Constant dimensions for different materials against steel ST 37 yield a changed operating distance.

The following table lists approximate values for the material dependent reduction factors. In practical applications variations could occur due to different alloying, for example.

Material	Operating distance in %
Stell ST37	100
Stainless steel	70
Brass (Br)	50
Copper (Cu)	45
Aluminium (Al)	40

Rated operating distance s_n

The rated operating distance is a device parameter that does not take into account sample variances and external influences such as temperature and supply voltages.

Effective operating distance s_r

The effective operating distance is the operating distance at nominal voltage and a nominal temperature of 23 °C. It is between 90% and 110% of the rated operating distance.

Usable operating distance s_u

The usable operating distance lies in the entire allowable temperature and voltage range between 90% and 110% of the effective operating distance.

Assured operating distance s_a

The assured operating distance takes into account all the external influences and sample variances and lies in the range from 0% to 80% of the usable operating distance. Within this range a guaranteed switching is ensured.

Switch point drift

The operating distances are given for an ambient temperature of 23 °C. In the permissible temperature range the operating distance varies by less than 15% from the value at 23 °C. The temperature of the measured object has no influence on the switch point.

Hysteresis H

The switching hysteresis describes the distance between the turn-on point while approaching an object and the turn-off point during the separation of it from the sensor. The hysteresis brings about a stable switching signal even when there are vibrations, temperature drift, or electrical variations. The hysteresis is defined in EN 60947-5-2 as a maximum 20% from the effective operating distance, and carries a value of typically 10% from the effective operating distance s_r for EGE sensors.

Repeating accuracy R

The repeating accuracy describes the maintenance of the switching point after the repeated approach of an object under specified circumstances. EGE sensors have typical tolerances of less than 3% of the effective operating distance.

Switching frequency

The maximum switching frequency of the sensor is determined at half rated operating distance s_n with standard measurement plates to EN 60947-5-2

Inductive Sensors

Technique & Application

Terminology/Installation and operation

Operating voltage

The operating voltage is the voltage range within EGE sensors function safely. For a constant voltage supply it is important to make sure that the limits are still observed when the residual ripple is included.

Switching current

This current gives the maximum long-term current for the switching output of the sensor at an ambient temperature of 25 °C and ohmic load. At an elevated ambient temperature, the current load capability decreases. For analog outputs, the boundary values given in the appropriate technical data, and particularly the permissible values for resistance loads, must be observed.

Short circuit protection

The short circuit protection ensures the sensor against destruction through a short circuit on the output. After removal of the fault, the output is reactivated. Where a maximum overload current is listed, this should not be exceeded.

Excess-current release

This value indicates the median value of current at which the short circuit protection responds with a tolerance of $\pm 20\%$.

Reverse polarity protection

The reverse polarity protection prevents destruction of the sensor by a reversal of the polarity of the voltage supply.

Voltage drop U_d

The voltage drop arises at the internal resistance of semiconductor elements, which are in the current-path of the output. It is dependent of the load-current and is declared according to EN 60947-5-2 for a mean current of 50 mA.

Residual current I_r

The residual current flows in the load current circuit when the output is blocked. The residual current must be considered when switching sensors in parallel.

Minimum load current I_m

The minimum load current is necessary for flawless operation with two-wire devices.

Current consumption

The current consumption is the maximum value of the no-load current I_0 that the sensor can absorb without a load.

Ambient temperature

The ambient temperature indicates the maximum allowable temperature range for the sensor.

Electromagnetic compatibility EMC

The EMC class is a measure of the noise immunity of the sensor against external electrical and magnetic influences. The information is based on the standard EN 61000-6-2.

Switch-on impulse suppression

EGE sensors have a switch-on suppression that blocks the output during the switch-on phase, when the operational voltage is applied.

Protective system

The protective system indicates the protection of the sensors against penetration of foreign bodies and water to EN 60529.

LED display

EGE sensors with yellow light-emitting diodes indicate the switching status optically.

Housing material

The housing material determines the chemical resistance of the sensor against external influences. For special applications, other housing materials are available.

Connection

The connection of the sensors is accomplished through plug-in connections or cables. Different cable types and lengths are available upon request.

Instructions for mounting

Mounting

For flush mounting the sensor can be built into metal up to its active surface without changing its characteristics. For non-flush mounting a metal-free zone around the sensor must be allowed for. A free zone to the material opposite the sensor must be maintained for all sensors.

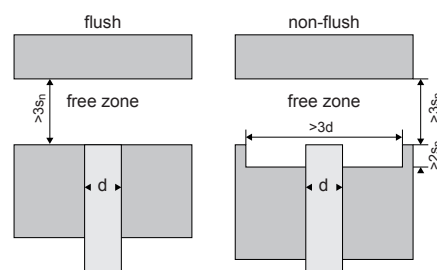

The indicated free zones are in accordance with the standard EN 60947-5-2.

Fixing nuts are part of delivery for all metal thread sensors.

For mounting clamps see page 3.71.

Inductive Sensors

Technique & Application

Installation and operation

Collocation

When collocating the sensors, a minimum separation must be kept between the devices. When in doubt, a test should be conducted under application conditions. For flush mounting the lateral separation between two sensors must correspond to at least the diameter of the sensor. For non flush mounting, the lateral separation from each other must correspond to at least twice the diameter of the sensor. For oppositely mounted sensors, a minimal separation of six times the rated operating distance should be allowed.

Torques

In order to prevent destruction of the threaded bushing during fitting, the following maximum torques must not be exceeded:

Design	Metal housing	Plastic housing
M5x0.5	3 Nm	–
M8x1	6 Nm	0.25 Nm
M12x1	10 Nm	1 Nm
M18x1	25 Nm	2 Nm
M30x1.5	40 Nm	5 Nm

PTFE sensors may only be tightened by hand.

Instructions for operation

Serial connection

For the serial connection of two wire or three wire sensors the individual voltage drops are added together. Therefore there is a lesser operational voltage at the disposal of the load. The addition of the switch-on delay times should be noted.

Parallel connection

The parallel connection of two wire sensors can only be conditionally recommended since the residual currents are added together and flow through the load. For the parallel connection of three wire sensors, the current consumption of the individual devices is added together. Since this current does not flow through the load, the maximum number of parallel connectable three wire sensors depends only on the power supply.

Approval for safety applications

Sensors for personal security must have a qualification approval according to EN 61508 and must be labeled accordingly. Sensors that are not labeled must not to be used for applications of this kind.



Probes Compact models Amplifiers





Metal face sensors | Plug connection

Proximity switches

M12 / M18 / M30
One piece stainless steel housing

DC 10...30 V

Shock resistant
Impact proof



Design	DC PNP M12 • M18 • M30			DC 2-Wire M12 • M18 • M30					
Dimensions									
Operating distance sn [mm]	2	5	10	2	5	10			
Switching output PNP									
ID-No.	P31193	P31194	P31195	P31225	P31226	P31227			
Type	IGVU 02 GSP	IGVU 05 GSP	IGVU 10 GSP	IGVU 02 GS	IGVU 05 GS	IGVU 10 GS			
Supply voltage [V]	10...30 DC			8...30 DC					
Switching current [mA]	250			150					
Short circuit proof	•			•					
Reverse protection	•			•					
Voltage drop max. [V]	1.5			3.5					
Current consumption [mA]	5			1.5					
Switching frequency [Hz]	180	180	150	180	180	150			
Ambient temperature [°C]	-25...+80			-25...+80					
EMC-class	A			A					
Protection [EN 60529]	IP 68 + IP 69			IP 68 + IP 69					
LED display	•			•					
Housing material	AISI 316 L			AISI 316 L					
Connection	M12 connector			M12 connector					
The specified operating distance (sn) applies to ferromagnetic objects (ST37).									
Accessories	connecting cable type SLG 3-2 (Z01076), page 3.69								



Metal face sensors | Cable connection

Proximity switches

M12 / M18 / M30
One piece stainless steel housing

DC 10...30 V

Shock resistant
Impact proof



Design	DC PNP • M12x1	DC PNP • M18x1	DC PNP • M30x1.5
Dimensions			
Operating distance sn [mm]	2	5	10
Switching output PNP			
ID-No.	P31228	P31229	P31230
Type	IGV 02 GSP	IGV 05 GSP	IGV 10 GSP
Supply voltage [V]	10...30 DC		
Switching current [mA]	250		
Short circuit proof	•		
Reverse protection	•		
Voltage drop max. [V]	1.5		
Current consumption [mA]	max. 5		
Switching frequency [Hz]	180	180	150
Ambient temperature [°C]	-25...+80		
EMC-class	A		
Protection [EN 60529]	IP 67		
LED display	•		
Housing material	AISI 316 L		
Connection	2 m PVC-cable 3x0.34 mm ²		
The specified operating distance (sn) applies to ferromagnetic objects (ST37).			



Metal face sensors | PTFE-coated

Proximity switches

M12 / M18 / M30
One piece stainless steel housing

DC 10...30 V

Shock resistant
Impact proof



Design	DC PNP • M12x1	DC PNP • M18x1	DC PNP • M30x1.5
Dimensions			
Operating distance sn [mm]	2	5	10
Switching output PNP			
ID-No.	P31234	P31235	P31236
Type	IGVU 02 GSP-C	IGVU 05 GSP-C	IGVU 10 GSP-C
Supply voltage [V]	10...30 DC		
Switching current [mA]	250		
Short circuit proof	•		
Reverse protection	•		
Voltage drop max. [V]	1.5		
Current consumption [mA]	5		
Switching frequency [Hz]	180	180	150
Ambient temperature [°C]	-25...+80		
EMC-class	A		
Protection [EN 60529]	IP 68 + IP 69		
LED display	•		
Housing material	AISI 316 L, PTFE-coated		
Connection	M12 connector		
The specified operating distance (sn) applies to ferromagnetic objects (ST37).	Design with fixed cable on request		
Accessories	connecting cable SLG 3-2 (Z01076), page 3.69		



Metal face sensors | Climatic-proofed

Proximity switches

M12 / M18 / M30
One piece stainless steel housing

DC 10...30 V

Shock resistant
Impact proof



Design	DC PNP • M12x1	DC PNP • M18x1	DC PNP • M30x1.5
Dimensions			
Operating distance sn [mm]	2	5	10
Switching output PNP			
ID-No.	P31237	P31238	P31239
Type	IGWV 02 GSP	IGWV 05 GSP	IGWV 10 GSP
Supply voltage [V]	10...30 DC		
Switching current [mA]	250		
Short circuit proof	•		
Reverse protection	•		
Voltage drop max. [V]	1.5		
Current consumption [mA]	8		
Switching frequency [Hz]	180	180	150
Ambient temperature [°C]	-10...+110		
EMC-class	A		
Protection [EN 60529]	IP 68 + IP 69		
Housing material	AISI 316 L		
Connection	2 m FEP-cable 3x0.34 mm ²		
The specified operating distance (sn) applies to ferromagnetic objects (ST37).			



Mounting clamp | For metal face sensors

Impact- and shock resistant,
protected installation

Simple adjustment
via slotted holes

Mount and replace sensor
quickly and precisely



Design **KBM 012 • KBM 018 • KBM 030**

Dimensions

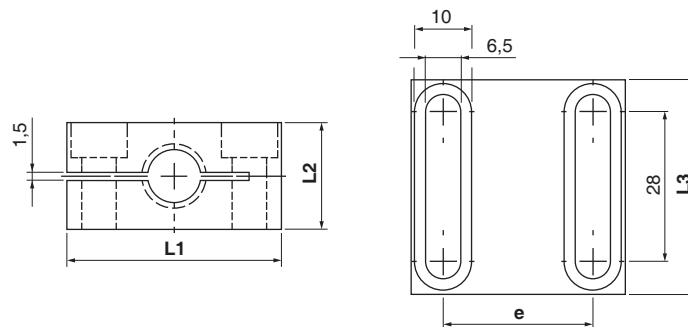

ID-No.	Z01209	Z01210	Z01211	Z01212	Z01213	Z01214
Type	KBM 012 A-ST52	KBM 018 A-ST52	KBM 030 A-ST52	KBM 012 B-A2	KBM 018 B-A2	KBM 030 B-A2
For sensor design	M12	M18	M30	M12	M18	M30
Dimensions						
L1 x L2 x L3 [mm]	34 x 24 x 40	40 x 30 x 40	55 x 40 x 40	34 x 24 x 40	40 x 30 x 40	55 x 40 x 40
Hole spacing e [mm]	20	26	40	20	26	40
Sensor installation	flushed relative to the set back surface			set back		
Housing material	ST52, hardened			AISI 303		

Note:
Mounting clamps are fastened to their metal surface using M6 hexagon socket screws. Make sure that the provided stainless steel washers have been placed in-between.

The typical torque is 6 Nm.

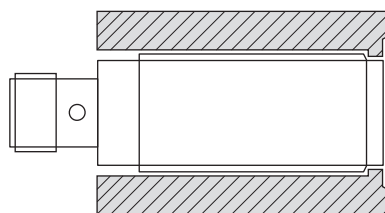

flushed relative to the set back surface

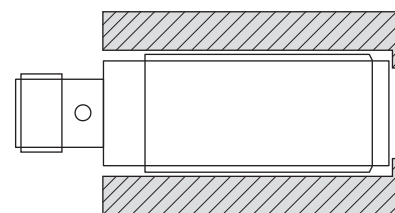

set back



POLAR-Series DC | Climativ-proofed -60 °C

Proximity switches

**M12 / M18 / M30
Stainless steel sleeve**

DC 10...30 V

**IP 68 Water-proofed
IP 69 Resistant to
high pressure cleaning**



Design	DC PNP • M12x1		DC PNP • M18x1		DC PNP • M30x1.5	
Dimensions						
Installation flush (f) non flush (nf)						
Operating distance sn [mm]	2 f	4 nf	5 f	7 nf	10 f	15 nf
Switching output PNP						
ID-No.	P31145	P31146	P31147	P31148	P31219	P31220
Type	IGMP 02 GSP	IGMP 04 GSP	IGMP 05 GSP	IGMP 08 GSP	IGMP 010 GSP	IGMP 015 GSP
Supply voltage [V]	10...30 DC					
Switching current [mA]	200					
Short circuit proof	•					
Overcurrent release [mA]	230					
Reverse protection	•					
Voltage drop max. [V]	2					
Load current [mA]	-					
Current consumption [mA]	4					
Switching frequency [Hz]	1000					
Ambient temperature [°C]	-55...+60					
Temperature min. [°C]	-60					
Temperature gradient [K/min]	5					
EMC-class	A					
Protection [EN 60529]	IP 68 + IP 69					
LED display	•					
Housing material	PTFE / AISI 316 Ti					
Connection	2 m FEP-cable 3x0.34 mm ²					
Switching current						



POLAR-Series AC | Climativ-proofed -60 °C

Proximity switches

M18
Stainless steel sleeve

AC 20...250 V

IP 68 Water-proofed
IP 69 Resistant to high pressure cleaning



Design	AC • M18x1	
Dimensions		
Installation flush (f) non flush (nf)	f	nf
Operating distance sn [mm]	5 f	7 nf
Switching output		
ID-No.	P31149	P31150
Type	IGMP 005 WS	IGMP 008 WS
Supply voltage [V]	20...250 AC	
Switching current [mA]	300	
Short circuit proof	-	
Overcurrent release [mA]	-	
Reverse protection	-	
Voltage drop max. [V]	4.5	
Load current [mA]	5	
Current consumption [mA]	2.5	
Switching frequency [Hz]	25	
Ambient temperature [°C]	-55...+60	
Temperature min. [°C]	-60	
Temperature gradient [K/min]	5	
EMC-class	A	
Protection [EN 60529]	IP 68 + IP 69	
LED display	•	
Housing material	PTFE / AISI 316 Ti	
Connection	2 m FEP-cable 3x0.75 mm ²	



POLAR-Series | Climativ-proofed –80 °C

Proximity switches

M30

Stainless steel sleeve

IP 68 Water-proofed

–80 °C permanent temperature



Design	M30x1.5
Dimensions	
Installation flush (f) non flush (nf)	
Operating distance sn [mm]	3 nf
ID-No.	P31337
Type	IGMP 030 S-80
Supply voltage [V]	–
Switching current [mA]	–
Hysteresis max. [%]	10
Short circuit proof	–
Reverse protection	–
Current consumption [mA]	–
Switching frequency [Hz]	–
Ambient temperature [°C]	–80...+50
EMC-class	A
Protection [EN 60529]	IP 68
LED display	–
Housing material	PTFE / AISI 316 Ti
Connection	2 m FEP-cable 3x0.75 mm ² , shielded
Sensor for the connection to amplifier IKM 120..., see page 3.34	



TROPICAL-Series DC | Climatic-proofed 120 °C

Proximity switches

M12 / M18-short form
Stainless steel sleeve

DC 10...30 V

IP 68 Water-proofed
IP 69 Resistant to
high pressure cleaning



Design	DC PNP • M12x1		DC PNP • M18x1	
Dimensions				
Installation flush (f) non flush (nf)				
Operating distance sn [mm]	2 f	4 nf	5 f	7 nf
GSP ID-No.	P31132	P31133	P30701	P30703
Type	IGMF 02 GSP	IGMF 04 GSP	IGMF 05 GSP	IGMF 08 GSP
GOP ID-No.			P30702	P30704
Type			IGMF 05 GOP	IGMF 08 GOP
Supply voltage [V]	10...30 DC			
Switching current [mA]	200			
Overcurrent release [mA]	230			
Current consumption [mA]	4			
Residual current [µA]	1			
Voltage drop max. [V]	2			
Switching frequency [Hz]	1000			
Ambient temperature [°C]	-25...+120			
Compressive strength [bar]	10			
Residual ripple max. [%]	10			
EMC-class	A			
Protection [EN 60529]	IP 68 + IP 69			
Housing material	PTFE / AISI 316 Ti (A4)			
Connection	2 m FEP-cable 3x0.34 mm ²			
Switching current				



TROPICAL-Series DC | Climatic-proofed 120 °C

Proximity switches

M18 / M30
Stainless steel sleeve

DC 10...30 V

IP 68 Water-proofed
IP 69 Resistant to
high pressure cleaning



Design	DC PNP • M18x1		DC PNP • M30x1.5	
Dimensions				
Installation flush (f) non flush (nf)				
Operating distance sn [mm]	5 f	7 nf	10 f	15 nf
GSP	ID-No. P31424 Type IGMF 005 GSP	ID-No. P31426 Type IGMF 008 GSP	ID-No. P31428 Type IGMF 010 GSP	ID-No. P31430 Type IGMF 015 GSP
GOP	ID-No. P31425 Type IGMF 005 GOP	ID-No. P31427 Type IGMF 008 GOP	ID-No. P31429 Type IGMF 010 GOP	ID-No. P31431 Type IGMF 015 GOP
GSOP	ID-No. P30707 Type IGMF 005 GSOP	ID-No. P30710 Type IGMF 008 GSOP	ID-No. P30713 Type IGMF 010 GSOP	ID-No. P30716 Type IGMF 015 GSOP
Supply voltage [V]	10...30 DC			
Switching current [mA]	200			
Overcurrent release [mA]	230			
Current consumption [mA]	4			
Residual current [µA]	1			
Voltage drop max. [V]	2			
Switching frequency [Hz]	1000			
Ambient temperature [°C]	-25...+120			
Compressive strenght [bar]	10			
EMC-class	A			
Protection [EN 60529]	IP 68 + IP 69			
Housing material	PTFE / AISI 316 Ti (A4)			
Connection	2 m FEP-cable 3x0.34 mm ² / 2 m FEP-cable 4x0.25 mm ²			
Switching current				
	GSP/GOP 		GSOP 	



TROPICAL-Series AC | Climatic-proofed 120 °C

Proximity switches

M18 / M30
Stainless steel sleeve

AC 20...250 V

IP 68 Water-proofed
IP 69 Resistant to high pressure cleaning



Design	AC • M18x1		AC • M30x1.5	
Dimensions				
Installation flush (f) non flush (nf)				
Operating distance sn [mm]	5 f	7 nf	10 f	15 nf
WS	ID-No. P31071 Type IGMF 005 WS	ID-No. P31073 Type IGMF 008 WS	ID-No. P31075 Type IGMF 010 WS	ID-No. P31077 Type IGMF 015 WS
WO	ID-No. P31070 Type IGMF 005 WO	ID-No. P31072 Type IGMF 008 WO	ID-No. P31074 Type IGMF 010 WO	ID-No. P31076 Type IGMF 015 WO
Supply voltage WS/WO [V]	20...250 AC			
Switching current WS/WO [mA]	< 400			
Current consumption [mA]	< 2.5			
Voltage drop max. [V]	< 5 eff.			
Switching frequency [Hz]	25			
Ambient temperature [°C]	-25...+120			
Compressive strength [bar]	10			
Minimum load current [mA]	5.0			
EMC-class	A			
Protection [EN 60529]	IP 68 + IP 69			
Housing material	PTFE / AISI 316 Ti (A4)			
Connection	2 m FEP-cable 3x0.75 mm ²			
Switching current				



TROPICAL-Series DC | Climatic-proofed 120 °C

Proximity switches

M12 / M18-short form
Stainless steel sleeve

DC 10...30 V

IP 68 Water-proofed
IP 69 Resistant to
high pressure cleaning
Steam proof



Design	DC PNP • M12x1		DC PNP • M18x1	
Dimensions				
Installation flush (f) non flush (nf)				
Operating distance sn [mm]	2 f	4 nf	5 f	7 nf
GSP ID-No.	P31338	P31339	P31340	P31341
Type	IGMW 02 GSP	IGMW 04 GSP	IGMW 05 GSP	IGMW 08 GSP
GOP ID-No.			P31342	P31343
Type			IGMW 05 GOP	IGMW 08 GOP
Supply voltage [V]	10...30 DC			
Switching current [mA]	200			
Overcurrent release [mA]	230			
Current consumption [mA]	4			
Residual current [µA]	1			
Voltage drop max. [V]	2			
Switching frequency [Hz]	1000			
Ambient temperature [°C]	-25...+120			
Compressive strength [bar]	4			
Residual ripple max. [%]	10			
EMC-class	A			
Protection [EN 60529]	IP 68 + IP 69			
Housing material	PTFE / AISI 316 Ti (A4)			
Connection	2 m FEP-cable 3x0.34 mm ²			
Switching current				



TROPICAL-Series DC | Climatic-proofed 120 °C

Proximity switches

M18 / M30
Stainless steel sleeve

DC 10...30 V

IP 68 Water-proofed
IP 69 Resistant to
high pressure cleaning
Steam proof



Design	DC PNP • M18x1		DC PNP • M30x1,5	
Dimensions				
Installation flush (f) non flush (nf)				
Operating distance sn [mm]	5 f	7 nf	10 f	15 nf
GSP	ID-No. P31432 Type IGMW 005 GSP	ID-No. P31434 Type IGMW 008 GSP	ID-No. P31436 Type IGMW 010 GSP	ID-No. P31438 Type IGMW 015 GSP
GOP	ID-No. P31433 Type IGMW 005 GOP	ID-No. P31435 Type IGMW 008 GOP	ID-No. P31437 Type IGMW 010 GOP	ID-No. P31439 Type IGMW 015 GOP
GSOP	ID-No. P31352 Type IGMW 005 GSOP	ID-No. P31353 Type IGMW 008 GSOP	ID-No. P31354 Type IGMW 010 GSOP	ID-No. P31355 Type IGMW 015 GSOP
Supply voltage [V]	10...30 DC			
Switching current [mA]	200			
Overcurrent release [mA]	230			
Current consumption [mA]	4			
Residual current [µA]	1			
Voltage drop max. [V]	2			
Switching frequency [Hz]	1000			
Ambient temperature [°C]	-25...+120			
Compressive strenght [bar]	4			
EMC-class	A			
Protection [EN 60529]	IP 68 + IP 69			
Housing material	PTFE / AISI 316 Ti (A4)			
Connection	2 m FEP-cable 3x0.34 mm ² / 2 m FEP-cable 4x0.25 mm ²			
Switching current				



TROPICAL-Series AC | Climatic-proofed 120 °C

Proximity switches

M18 / M30
Stainless steel sleeve

AC 20...250 V

IP 68 Water-proofed
IP 69 Resistant to
high pressure cleaning
Steam proof



Design	AC • M18x1		AC • M30x1.5	
Dimensions				
Installation flush (f) non flush (nf)				
Operating distance sn [mm]	5 f	7 nf	10 f	15 nf
WS ID-No.	P31356	P31357	P31358	P31359
Type	IGMW 005 WS	IGMW 008 WS	IGMW 010 WS	IGMW 015 WS
WO ID-No.	P31360	P31361	P31362	P31363
Type	IGMW 005 WO	IGMW 008 WO	IGMW 010 WO	IGMW 015 WO
Supply voltage WS/WO [V]	20...250 AC			
Switching current WS/WO [mA]	< 400			
Current consumption [mA]	< 2.5			
Voltage drop max. [V]	< 5 eff.			
Switching frequency [Hz]	25			
Ambient temperature [°C]	-25...+120			
Compressive strength [bar]	4			
Minimum load current [mA]	5.0			
EMC-class	A			
Protection [EN 60529]	IP 68 + IP 69			
Housing material	PTFE / AISI 316 Ti (A4)			
Connection	2 m FEP-cable 3x0.75 mm ²			
Switching current				



TROPICAL-Series DC | Resistant to rolling oil

Proximity switches

PTFE housing

DC 10...30 V

IP 68 Water-proofed
IP 69 Resistant to high pressure cleaning



Design	DC PNP • M30x1.5				DC • Ø 35
Dimensions					
Installation flush (f) non flush (nf)	f		nf		nf
Operating distance sn [mm]	10 f	10 f	14 nf	14 nf	19 nf
Switching output (DC PNP)					
ID-No.	P31440	P31455	P31441	P31456	P31442
Type	IGFW 010 GSP	IGFW 010 GOP	IGFW 015 GSP	IGFW 015 GOP	INFW 020 GSP
Supply voltage [V]	10...30 DC				
Switching current [mA]	< 200				
Surge current [mA]	short circuit protection				
Current consumption [mA]	4				
Inverse current max. [µA]	1				
Voltage drop [V]	2				
Ambient temperature [°C]	-25...+120				
Temperature deviation [%]	10 (-25...+70 °C), 20 (-25...+120 °C)				
Overcurrent release approx. [mA]	230				
Reverse Protection	•				
Minimum load current [mA]	-				
EMC-class	A				
Switching frequency [Hz]	1000				500
Protection [EN 60529]	IP 68 + IP 69				
Housing material	PTFE				
Connection	2 m FEP-cable 0.34 mm ²				
Switching current					
Accessories	nut M30x1.5 (Z00120), clamp Ø 35 (Z00125), page 3.71				

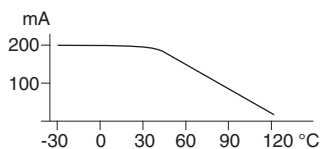



TROPICAL-Series AC | Resistant to rolling oil

Proximity switches

PTFE housing

AC 20...250 V

IP 68 Water-proofed

IP 69 Resistant to high pressure cleaning



Design	AC • M30x1.5		AC • Ø35
Dimensions			
Installation flush (f) non flush (nf)			
Operating distance sn [mm]	10 f	14 nf	19 nF
Switching output			
ID-No.	P30626	P30638	P30650
Type	IGFW 010 WS	IGFW 015 WS	INFW 020 WS
Supply voltage [V]	20...250 AC		
Switching current [mA]	< 400		
Current consumption [mA]	2.5		
Voltage drop [V]	5 eff.		
Switching frequency [Hz]	20		
Ambient temperature [°C]	-25...+120		
Temperature deviation [%]	10 (-25...+70 °C), 20 (-25...+120 °C)		
Minimum load current [mA]	5.0		
EMC-class	A		
Protection [EN 60529]	IP 68 + IP 69		
Housing material	PTFE		
Connection	2 m Silicone-cable 0.75 mm ²		
Switching current			
Accessories	nut M30x1.5 (Z00120), clamp Ø35 (Z00125), page 3.71		



TROPICAL-Series | Resistant to rolling oil

Proximity switches

DC 10...55 V

Climatic-proofed
Resistant to acid

Armoured cable
with IP 68-plug



Design	DC PNP • M30x1.5	DC PNP • Ø 35
Dimensions		
Installation flush (f) non flush (nf)	LED	LED
Operating distance sn [mm]	10 f	20 nf
Switching output PNP		
ID-No.	P31443	P31444
Type	IGMF 010 GSP-PZ	INFW 020 GSP-PZ
Supply voltage [V]	10...30 DC	10...30 DC
Switching current max. [mA]	200	200
Current consumption [mA]	4	4
Switching frequency [Hz]	1000	500
Ambient temperature [°C]	-25...+120	-25...+120
Compressive strength [bar]	10	-
Protection [EN 60529]	IP 68 + IP 69	IP 68 + IP 69
Function indicator	LED	LED
Housing material	PTFE, AISI 316 Ti	PTFE
Connection	5 m FEP-cable 3x0.34mm ² armoured cable	5 m FEP-cable 3x0.34mm ² armoured cable
Plug, Lemo series K, 3-pol		
Sensors without plug on request		
Accessories	junction box GS..., page 3.25	



Junction box | Resistant to rolling oil

Connection of sensors with armoured cable

IP 68-plug



Design	GS 125	GS 175	GS 250
Dimensions			
ID-No.	P31212	P31217	P31218
Type	GS 125	GS 175	GS 250
Connectable sensors	2	3	4
Supply voltage [V]	10...55 DC	10...55 DC	10...55 DC
Ambient temperature [°C]	-20...+75	-20...+75	-20...+75
Protection [EN 60529]	IP 68	IP 68	IP 68
Housing material	Aluminium	Aluminium	Aluminium
Connection	10 m TPE-numbered cable 7x0.5mm ²	10 m TPE-numbered cable 7x0.5mm ²	10 m TPE-numbered cable 7x0.5mm ²

Plug, Lemo series K, 3-pol

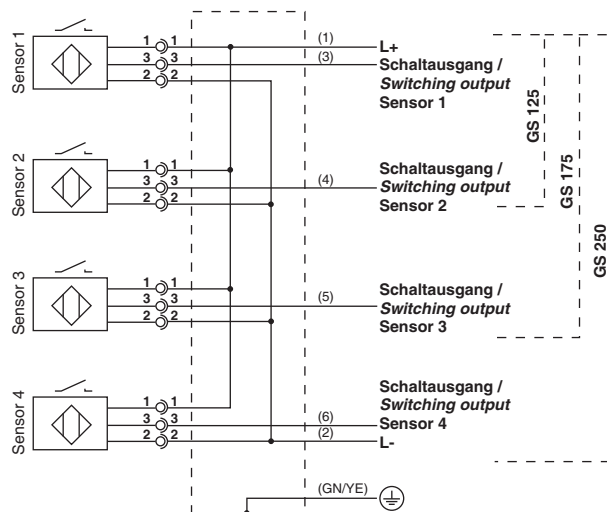
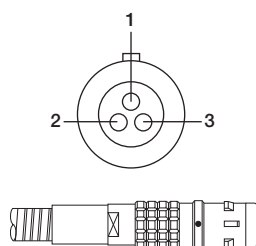

Notice

for sensors IGMF 010 GSP-PZ / INFW 020 GSP-PZ, page 3.24



High temperature 120 °C | DC

Proximity switches

M12 / M18 / M30
Metal sleeve

DC 10...48 V

Extended
temperature range
-25 °C...+120 °C



Design	DC PNP • M12x1		DC PNP • M18x1		DC PNP • M30x1.5	
Dimensions						
Installation flush (f) non flush (nf)	f, nf		f, nf		f, nf	
Operating distance sn [mm]	2 f	4 nf	5 f	8 nf	10 f	15 nf
Switching output PNP						
ID-No.	P31282	P31283	P31290	P31291	P31292	P31293
Type	IGMT 02 GSP	IGMT 04 GSP	IGMT 005 GSP	IGMT 008 GSP	IGMT 010 GSP	IGMT 015 GSP
Supply voltage [V]	10...48 DC					
Switching current [mA]	200					
Short circuit proof	•					
Reverse protection	•					
Voltage drop max. [V]	2					
Current consumption [mA]	4					
Switching frequency [Hz]	500					
Ambient temperature [°C]	-25...+120					
EMC-class	A					
Protection [EN 60529]	IP 67					
LED display	•					
Housing material	Br-Ni / PBT					
Connection	2 m Silicone-cable 3x0.34 mm ²					
Switching current						
Notes	design with M12 connector on request					



High temperature 120 °C | AC

Proximity switches

M18 / M30
Metal sleeve

AC 20...250 V

Extended
temperature range
-25 °C...+120 °C



Design	AC • M18x1		AC • M30x1.5	
Dimensions				
Installation flush (f) non flush (nf)				
Operating distance sn [mm]	5 f	8 nf	10 f	15 nf
Switching output				
ID-No.	P31118	P31119	P31120	P31121
Type	IGMT 005 WS	IGMT 008 WS	IGMT 010 WS	IGMT 015 WS
Supply voltage [V]	20...250 AC			
Switching current [mA]	200			
Short circuit proof	-			
Reverse protection	-			
Voltage drop max. [V]	5 eff.			
Minimum load current [mA]	5			
Current consumption [mA]	2.5			
Switching frequency [Hz]	25			
Ambient temperature [°C]	-25...+120			
EMC-class	A			
Protection [EN 60529]	IP 67			
LED display	•			
Housing material	Br-Ni / PBT			
Connection	2 m Silicone-cable 3x0.75 mm ²			
Switching current				



High temperature 120 °C | AC / DC

Proximity switches

DC 10...55 V
AC 20...250 V

Extended sensing range

Extended temperature range
-25 °C...+120 °C



Design	Ø 80 mm		Ø 105 mm		Ø 160 mm	
Dimensions						
Installation non flush (nf)						
Operating distance sn [mm]	50 nf	45 nf	80 nf	60 nf	110 nf	100 nf
Switching output (DC PNP)						
ID-No.	P31276	P31279	P31277	P31280	P31278	P31281
Type	IDT 080 GSP	IDT 080 WS	IDT 105 GSP	IDT 105 WS	IDT 160 GSP	IDT 160 WS
Supply voltage [V]	10...55 DC	20...250 AC	10...55 DC	20...250 AC	10...55 DC	20...250 AC
Switching current [mA]	400	400	400	400	400	400
Short circuit proof	•	-	•	-	•	-
Reverse protection	•	-	•	-	•	-
Voltage drop max. [V]	2	5 eff.	2	5 eff.	2	5 eff.
Minimum load current [mA]	-	5	-	5	-	5
Current consumption [mA]	4	2.5	4	2.5	4	2.5
Switching frequency [Hz]	20	10	20	10	20	10
Ambient temperature [°C]	-25...+120					
EMC-class	A					
Protection [EN 60529]	IP 67					
Housing material	PBT / Aluminium					
Connection	2 m Silicone-cable 3x0.34 mm ²	2 m Silicone-cable 2x0.75 mm ²	2 m Silicone-cable 3x0.34 mm ²	2 m Silicone-cable 2x0.75 mm ²	2 m Silicone-cable 3x0.34 mm ²	2 m Silicone-cable 2x0.75 mm ²
Switching current						



High temperature 160 °C | DC

Proximity switches

M12 / M18 / M30
Stainless steel sleeve

DC 10...30 V

IP 68 Water-proofed
IP 69 Resistant to
high pressure cleaning



Design	DC PNP • M12x1		DC PNP • M18x1		DC PNP • M30x1.5	
Dimensions						
Installation flush (f) non flush (nf)						
Operating distance sn [mm]	2 f	4 nf	5 f	8 nf	10 f	15 nf
Switching output PNP						
ID-No.	P31288	P31289	P31161	P31162	P31163	P31164
Type	IGMH 02 GSP	IGMH 04 GSP	IGMH 005 GSP	IGMH 008 GSP	IGMH 010 GSP	IGMH 015 GSP
Supply voltage [V]	10...30 DC					
Switching current [mA]	200					
Short circuit proof	•					
Reverse protection	•					
Voltage drop max. [V]	2					
Residual current max. [mA]	0.02					
Current consumption (not actuated) [mA]	7					
Switching frequency [Hz]	200					
Temperature deviation [%]	15					
Ambient temperature [°C]	-25...+150			-25...+160		
EMC-class	A					
Protection [EN 60529]	IP 68 + IP 69					
LED display	-					
Housing material	AISI 316 Ti / PEEK					
Connection	2 m FEP-cable 3x0.34 mm ²					

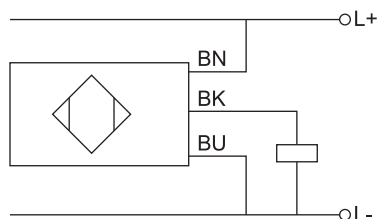
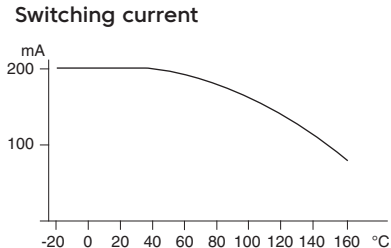

Notes temperature depending parameters are described in the technical manual



High temperature 160 °C | DC

Proximity switches

M12 / M18 / M30
Stainless steel sleeve

DC 10...30 V

Moisture resistant
Silicone-cable



Design	DC PNP • M12x1		DC PNP • M18x1		DC PNP • M30x1.5	
Dimensions						
Installation flush (f) non flush (nf)						
Operating distance sn [mm]	2 f	4 nf	5 f	8 nf	10 f	15 nf
Switching output PNP						
ID-No.	P31299	P31300	P31301	P31302	P31303	P31304
Type	IGMH 02 GSP-K	IGMH 04 GSP-K	IGMH 005 GSP-K	IGMH 008 GSP-K	IGMH 010 GSP-K	IGMH 015 GSP-K
Supply voltage [V]	10...30 DC					
Switching current [mA]	200					
Short circuit proof	•					
Reverse protection	•					
Voltage drop max. [V]	2					
Residual current max. [mA]	0.02					
Current consumption (not actuated) [mA]	7					
Switching frequency [Hz]	200					
Temperature deviation [%]	15					
Ambient temperature [°C]	-25...+150			-25...+160		
EMC-class	A					
Protection [EN 60529]	IP 67					
LED display	-					
Housing material	AISI 316 Ti / PEEK					
Connection	2 m Silicone-cable 3x0.34 mm ²					

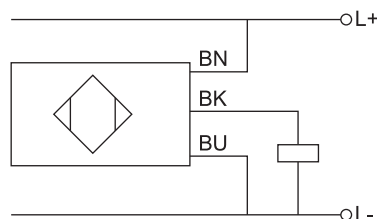
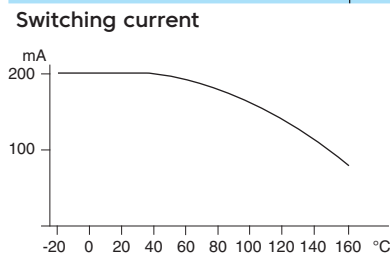

Notes temperature depending parameters are described in the technical manual



High temperature 250 °C

Proximity sensor

Armoured cable

With connector for cable amplifier



Design	Cuboid 40 mm	Ø 80 mm	DC PNP • M30x1.5
Dimensions Installation non flush (nf)			
Operating distance sn [mm]	20 nf, adjustable	40 nf, adjustable	amplifier
Switching output PNP			
ID-No.	P31294	P31295	P31204
Type	IRH 040 S250	IDH 080 S250	IK 030 GSP
Supply voltage [V]	-	-	10...30
Switching current [mA]	-	-	200
Current consumption [mA]	-	-	15
Voltage drop max. [V]	-	-	1.5
Ambient temperature [°C]	sensor: 0...+250 plug: -20...+70		0...+70
Short circuit proof	-	-	•
Reverse protection	-	-	•
EMC-class	A	A	A
Switching frequency [Hz]	30	30	30
Protection [EN 60529]	IP 60		IP 67
Function indicator	-	-	LED yellow
Stand-by indicator	-	-	LED green
Housing material	Aluminium / PEEK		AISI 316 Ti
Connection cable	5 m FEP-cable, Ø 8 mm armoured cable		-
Connection	M12 connector		M12 connector
t x1000 [h] Durability T [°C]			
Accessories	connecting cable SLG 3-2 (Z01076), page 3.69		



High temperature 250 °C

Armoured cable

With connector for cable amplifier and sensor

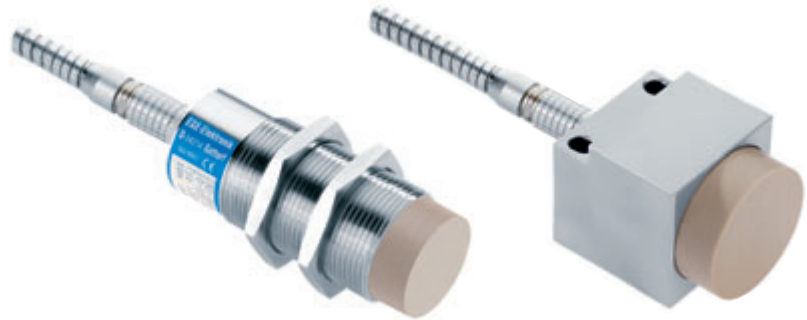

Design	M30x1.5	Cuboid 40 mm	Ø 80 mm
Dimensions			
Installation non flush (nf)			
Operating distance sn [mm]	15 nf, adjustable	20 nf, adjustable	40 nf, adjustable
ID-No.	P31298	P31296	P31297
Type	IGHS 030 S250	IRHS 040 S250	IDHS 080 S250
Supply voltage [V]		-	
Switching current [mA]		-	
Current consumption [mA]		-	
Voltage drop [V]		-	
Ambient temperature [°C]		0...+250	
Short circuit proof		-	
Reverse protection		-	
EMC-class		A	
Switching frequency [Hz]		30	
Protection [EN 60529]		IP 60	
Housing material	AISI 316 Ti / PEEK	Aluminium / PEEK	
Connection	M12 connector		
Connection cable (Accessories)	5 m FEP-cable, Ø 8 mm armoured cable (KAP 08-DS5, Z01190)		
Accessories	connecting cable SLG 3-2 (Z01076), page 3.69		



High temperature 200 °C

Proximity sensor

PTFE housing

No cooling



Design	INT020-S200		INT100-S180	
Dimensions				
Installation non flush (nf)				
Operating distance sn [mm]	15 nf		50 nf	
Adjustable range [mm]	5...20		10...80	
ID-No.	P31101	P30411	P31103	P30427
Type	INT020-S200 K	INT020-S200 GC	INT100-S180 K	INT100-S180 GC
Limiting temperature [°C]	250		200	
Nominal temperature [°C]	200		180	
Temperature deviation [mm/°C] (not linear)	0.05		0.06	
EMC-class	B			
Protection [EN 60529]	IP 40			
Housing material	PTFE			
Mounting	Aluminium plate			
Sensing material [ST 37]	40x40x1		100x100x1	
Connecting cable	5 m PTFE shielded			
Connection and required Amplifier	clamp connection IKM 120 GPP	plug C 16 IU 130...	clamp connection IKM 120 GPP	plug C 16 IU 130...
Special notes	If the ambient temperature exceeds 230 °C, there might be failed reactions from the sensor, but it will not be destroyed by this. The inductive high temperature proximity switches must be used with an amplifier. The connection cable can be up to 10 m long. We can supply the cable with a flexible aluminium tube on request.			
Connection diagram	Sensor-Connection sensors INT...K to IKM 120 GPP		Plug C 16: connection for Sensors INT...to IU 130...	
Amplifiers see page 3.34 - 3.35				
Temperature depending parameters are described in the technical manual				
Accessories	plug C 16			



Amplifier

For the connection of separate sensors for extreme temperatures

LED display



Design **IKM 120 GSOP**

Dimensions

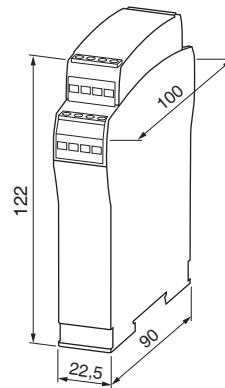

ID-No.	P31334
Type	IKM 120 GSOP
Switching output	 PNP
Supply voltage [V]	24 V DC ±20%
Switching current [mA]	400
Short circuit proof	•
Current consumption [mA]	max. 18
Operating distance	adjustable
Hysteresis max. [%]	10
Switching frequency [Hz]	100
Ambient temperature [°C]	-25...+75
EMC-class	A
Protection [EN 60529]	terminal: IP 20 / housing: IP 40
Function indicator	LED yellow
Stand-by indicator	LED green
Housing material	PA
Connection sensor	terminal screws
Connection Amplifier	terminal screws

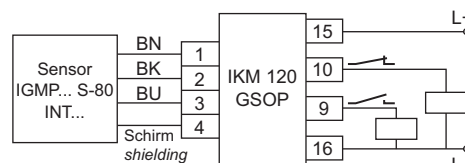



Amplifiers

For the connection of separate sensors

LED display



Design IU 130...

Dimensions

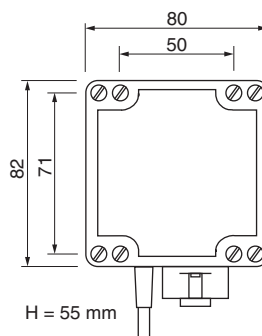

ID-No.	P30438	P30439
Type	IU 130 WP	IU 130 GPP
Supply voltage [V]	230 AC ±10%	24 DC ±10%
Switching current [mA]	400	
Short circuit proof	-	
Current consumption [mA]	15	
Operating distance	adjustable	
Hysteresis max. [%]	adjustable	
Output	programmable	
Switching frequency [Hz]	5	15
Ambient temperature [°C]	-20...+70	
EMC-class	A	
Protection [EN 60529]	IP 67	
Function indicator	LED yellow	
Stand-by indicator	LED green	
Housing material	PBT	
Connection sensor	C 16 plug connection	
Connection amplifier	2 m PVC-cable 4x0.75 mm²	2 m PVC-cable 3x0.50 mm²

connection amplifier

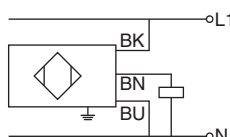

connection amplifier

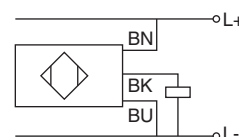

Accessories external plug C 16 (Z00039)



Demanding environment

Proximity switches

M12 / M18 / M30

Metal sleeve

DC 10...48 V

Short form

Increased EMC



Design	DC PNP • M12x1		DC PNP • M18x1		DC PNP • M30x1.5	
Dimensions						
Installation flush (f) non flush (nf)	LED		LED		LED	
Operating distance sn [mm]	2 f	4 nf	5 f	8 nf	10 f	15 nf
GSP	ID-No. P31246 Type IGMU 02 GSP	ID-No. P31247 Type IGMU 04 GSP	ID-No. P31305 Type IGMU 05 GSP	ID-No. P31306 Type IGMU 08 GSP	ID-No. P31307 Type IGMU 10 GSP	ID-No. P31308 Type IGMU 15 GSP
GSOP	-	-	ID-No. P31250 Type IGMU 05 GSOP	ID-No. P31251 Type IGMU 08 GSOP	ID-No. P31254 Type IGMU 10 GSOP	ID-No. P31255 Type IGMU 15
Supply voltage [V]	10...48 DC					
Switching current [mA]	200					
Short circuit proof	•					
Reverse protection	•					
Voltage drop max. [V]	2					
Current consumption [mA]	2.5					
Switching frequency [Hz]	500					
Ambient temperature [°C]	-25...+75					
EMC-class	A					
Protection [EN 60529]	IP 67					
LED display	•					
Housing material	Br-Ni / PBT					
Connection	M12 connector					

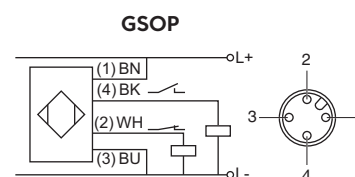
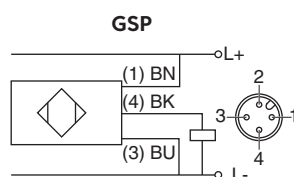

Accessories connecting cable SLG 3-2 (GSP) / SLG 4-2 (GSOP), page 3.69



Demanding environment

Proximity switches

M12 / M18 / M30

Metal sleeve

DC 10...48 V

Short form

Increased EMC



Design	DC PNP • M12x1		DC PNP • M18x1		DC PNP • M30x1.5	
Dimensions						
Installation flush (f) non flush (nf)						
Operating distance sn [mm]	2 f	4 nf	5 f	8 nf	10 f	15 nf
GSP	ID-No. P31244 Type IGM 02 GSP	ID-No. P31245 Type IGM 04 GSP	ID-No. P31309 Type IGM 05 GSP	ID-No. P31310 Type IGM 08 GSP	ID-No. P31311 Type IGM 10 GSP	ID-No. P31312 Type IGM 15 GSP
GSOP	-	-	ID-No. P31248 Type IGM 05 GSOP	ID-No. P31249 Type IGM 08 GSOP	ID-No. P31252 Type IGM 10 GSOP	ID-No. P31253 Type IGM 15 GSOP
Supply voltage [V]	10...48 DC					
Switching current [mA]	200					
Short circuit proof	•					
Reverse protection	•					
Voltage drop max. [V]	2					
Current consumption [mA]	2.5					
Switching frequency [Hz]	500					
Ambient temperature [°C]	-25...+75					
EMC-class	A					
Protection [EN 60529]	IP 67					
LED display	•					
Housing material	Br-Ni / PBT					
Connection	GSP: 2 m PVC-cable 3x0.34 mm ²			GSOP: 2 m PVC-cable 4x0.34 mm ²		

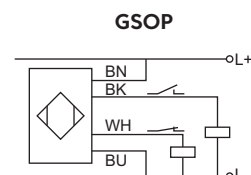
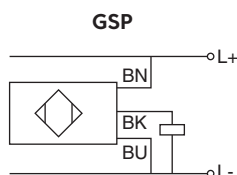



Demanding environment

Proximity switches

M18 / M30
Metal sleeve

DC 10...48 V
AC 20...250 V

Long form

Increased EMC



Design		DC PNP • M18x1	DC PNP • M30x1.5	AC • M30x1.5 programmable
Dimensions				
Installation				
Operating distance sn [mm]		5 f	8 nf	10 f
GSP		ID-No. P31313 Type IGMU 005 GSP	ID-No. P31314 Type IGMU 008 GSP	ID-No. P31315 Type IGMU 010 GSP
GSOP		ID-No. P31258 Type IGMU 005 GSOP	ID-No. P31259 Type IGMU 008 GSOP	ID-No. P31262 Type IGMU 010 GSOP
WP		ID-No. - Type -	ID-No. - Type -	ID-No. P30015 Type IGMS 010 WP
Supply voltage [V]		10...48 DC		20...250 AC
Switching current [mA]		200		400
Short circuit proof		•		3000 mA/10 ms
Reverse protection		•		-
Voltage drop max. [V]		2		6
Minimum load current [mA]		-		5
Current consumption [mA]		2.5		2.5
Switching frequency [Hz]		500		25
Ambient temperature [°C]		-25...+75		-25...+75
EMC-class		A		A
Protection [EN 60529]		IP 67		IP 67
LED display		•		•
Housing material		Br-Ni / PBT		Br-Ni / PBT
Connection		M12 connector		PG-plug connection 2 m PVC-cable 3x0.5 mm ²

Accessories

connecting cable SLG 3-2 (GSP) / SLG 4-2 (GSOP), page 3.69



Demanding environment

Proximity switches

M18 / M30
Metal sleeve

DC 10...48 V
AC 20...250 V

Long form

Increased EMC



Design	DC PNP • M18x1		DC PNP • M30x1.5		AC • M30x1.5	
Dimensions						
Installation flush (f) non flush (nf)						
Operating distance sn [mm]	5 f	8 nf	10 f	15 nf	10 f	15 nf
GSP	ID-No. P31317 Type IGM 005 GSP	ID-No. P31318 Type IGM 008 GSP	ID-No. P31319 Type IGM 010 GSP	ID-No. P31320 Type IGM 015 GSP	-	-
GSOP	ID-No. P31256 Type IGM 005 GSOP	ID-No. P31257 Type IGM 008 GSOP	ID-No. P31260 Type IGM 010 GSOP	ID-No. P31261 Type IGM 015 GSOP	-	-
WS	ID-No. - Type -	ID-No. - Type -	ID-No. - Type -	ID-No. - Type -	P30016 IGM 010 WS	P30020 IGM 015 WS
Supply voltage [V]	10...48 DC				20...250 AC	
Switching current [mA]	200				400	
Short circuit proof	•				3000 mA/10 ms	
Reverse protection	•				-	
Voltage drop max. [V]	2				6	
Minimum load current [mA]	-				5	
Current consumption [mA]	2.5				2.5	
Switching frequency [Hz]	500				25	
Ambient temperature [°C]	-25...+75				-25...+75	
EMC-class	A				A	
Protection [EN 60529]	IP 67				IP 67	
LED display	•				•	
Housing material	Br-Ni / PBT				Br-Ni / PBT	
Connection	GSP: 2 m PVC-cable, 3x0.34 mm ² GSOP: 2 m PVC-cable, 4x0.34 mm ²				2 m PVC-cable 3x0.5 mm ²	



Demanding environment

Proximity switches

Ø 80 mm

DC 10...55 V
AC 20...250 V

Sensing range adjustable

Increased EMC



Design	DC PNP • Ø 80 mm	DC PNP • Ø 80 mm	AC • Ø 80 mm programmable
Dimensions Installation non flush (nf)			
Operating distance sn [mm] (Adjustable range)	55 nf (25...80)	55 nf (25...80)	55 nf (25...80)
GSP ID-No.	P31321	P31322	-
Type	IDU 080 GSP	ID 080 GSP	-
GSOP ID-No.	P31264	P31265	-
Type	IDU 080 GSOP	ID 080 GSOP	-
WP ID-No.	-	-	P31266
Type	-	-	IDS 080 WP
Supply voltage [V]	10...55 DC	10...55 DC	20...250 AC
Switching current [mA]	400	400	400
Short circuit proof	•	•	3000 mA/10 ms
Reverse protection	•	•	-
Voltage drop max. [V]	2	2	6 eff.
Minimum load current [mA]	-	-	8
Current consumption [mA]	4	4	2.5
Switching frequency [Hz]	20	20	10
Ambient temperature [°C]	-25...+75	-25...+75	-25...+75
EMC-class	A	A	A
Protection [EN 60529]	IP 67	IP 67	IP 67
LED display	•	•	•
Housing material	PBT	PBT	PBT
Connection	M12 connector	GSP: 2 m PVC-cable, 3x0.5 mm ² GSOP: 2 m PVC-cable, 4x0.5 mm ²	PG-plug connection 2 m, 2x0.75 mm ² , PVC
Accessories	connecting cable SLG 3-2 (GSP) / SLG 4-2 (GSOP), page 3.69		



Demanding environment

Proximity switches

Ø 105 mm

DC 10...55 V
AC 20...250 V

Sensing range adjustable

Increased EMC



Design	DC PNP • Ø 105 mm	DC PNP • Ø 105 mm	AC • Ø 105 mm programmable
Dimensions Installation non flush (nf)			
Operating distance sn [mm] (Adjustable range)	100 nf (20...110)	100 nf (20...110)	70 nf (20...110)
GSP ID-No. Type	P31323 IDU 105 GSP	P31324 ID 105 GSP	-
GSOP ID-No. Type	P31267 IDU 105 GSOP	P31268 ID 105 GSOP	-
WP ID-No. Type	-	-	P31269 IDS 105 WP
Supply voltage [V]	10...55 DC	10...55 DC	20...250 AC
Switching current [mA]	400	400	400
Short circuit proof	•	•	3000 mA/10 ms
Reverse protection	•	•	-
Voltage drop max. [V]	2	2	6 eff.
Minimum load current [mA]	-	-	8
Current consumption [mA]	4	4	2.5
Switching frequency [Hz]	20	20	10
Ambient temperature [°C]	-25...+75	-25...+75	-25...+75
EMC-class	A	A	A
Protection [EN 60529]	IP 67	IP 67	IP 67
LED display	•	•	•
Housing material	PBT	PBT	PBT
Connection	M12 connector	GSP: 2 m PVC-cable, 3x0.5 mm ² GSOP: 2 m PVC-cable, 4x0.5 mm ²	PG-plug connection 2 m, 2x0.75 mm ² , PVC
	GSP 	GSOP 	WP
Accessories	connecting cable SLG 3-2 (GSP) / SLG 4-2 (GSOP), page 3.69		



Demanding environment

Proximity switches

Ø 160 mm

DC 10...55 V
AC 20...250 V

Sensing range adjustable

Increased EMC

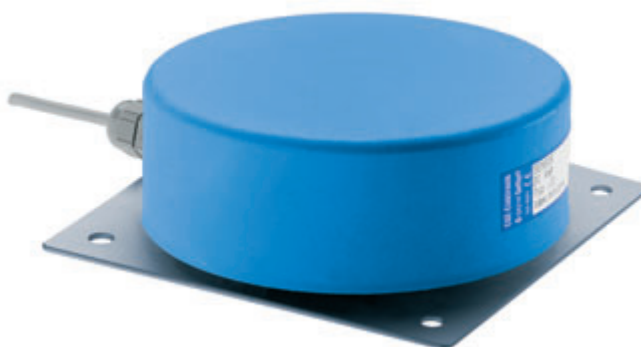

Design	DC PNP • Ø 160 mm	DC PNP • Ø 160 mm	AC • Ø 160 mm programmable
Dimensions Installation non flush (nf)			
Operating distance sn [mm] (Adjustable range)	120 nf (20...150)	120 nf (20...150)	120 nf (20...150)
GSP ID-No. P31325 Type IDU 160 GSP		P31326 ID 160 GSP	-
GSOP ID-No. P31270 Type IDU 160 GSOP		P31271 ID 160 GSOP	-
WP ID-No. - Type -		-	P31272 IDS 160 WP
Supply voltage [V]	10...55 DC	10...55 DC	20...250 AC
Switching current [mA]	400	400	400
Short circuit proof	•	•	3000 mA/10 ms
Reverse protection	•	•	-
Voltage drop max. [V]	2	2	6 eff.
Minimum load current [mA]	-	-	8
Current consumption [mA]	4	4	2.5
Switching frequency [Hz]	20	20	10
Ambient temperature [°C]	-25...+75	-25...+75	-25...+75
EMC-class	A	A	A
Protection [EN 60529]	IP 67	IP 67	IP 67
LED display	•	•	•
Housing material	PBT / Aluminium	PBT / Aluminium	PBT / Aluminium
Connection	M12 connector	GSP: 2 m PVC-cable, 3x0.5 mm ² GSOP: 2 m PVC-cable, 4x0.5 mm ²	PG-plug connection 2 m, 2x0.75 mm ² , PVC
	GSP 	GSOP 	WP
Accessories	connecting cable SLG 3-2 (GSP) / SLG 4-2 (GSOP), page 3.69		



Demanding environment

Proximity switches

Ø 200 mm

DC 10...55 V
AC 20...250 V

Sensing range adjustable

Increased EMC

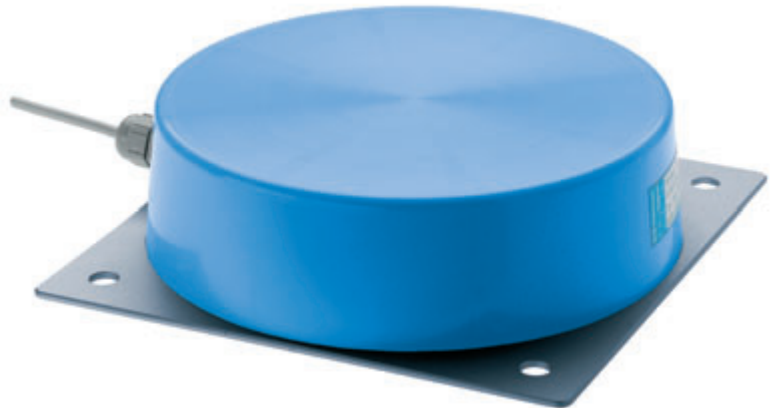

Design	DC PNP • Ø 200 mm	DC PNP • Ø 200 mm	AC • Ø 200 mm programmable
Dimensions Installation non flush (nf)			
Operating distance sn [mm] (Adjustable range)	140 nf (40...170)	140 nf (40...170)	140 nf (40...170)
GSP ID-No. Type	P31327 IDU 200 GSP	P31328 ID 200 GSP	-
GSOP ID-No. Type	P31273 IDU 200 GSOP	P31274 ID 200 GSOP	-
WP ID-No. Type	-	-	P31275 IDS 200 WP
Supply voltage [V]	10...55 DC	10...55 DC	20...250 AC
Switching current [mA]	400	400	400
Short circuit proof	•	•	3000 mA/10 ms
Reverse protection	•	•	-
Voltage drop max. [V]	2	2	6 eff.
Minimum load current [mA]	-	-	8
Current consumption [mA]	4	4	2.5
Switching frequency [Hz]	20	20	10
Ambient temperature [°C]	-25...+75	-25...+75	-25...+75
EMC-class	A	A	A
Protection [EN 60529]	IP 67	IP 67	IP 67
LED display	•	•	•
Housing material	PBT / Aluminium	PBT / Aluminium	PBT / Aluminium
Connection	M12 connector	GSP: 2 m PVC-cable, 3x0.5 mm ² GSOP: 2 m PVC-cable, 4x0.5 mm ²	PG-plug connection 2 m, 2x0.75 mm ² , PVC
	GSP 	GSOP 	WP
Accessories	connecting cable SLG 3-2 (GSP) / SLG 4-2 (GSOP), page 3.69		



Analog output

Proximity sensors

M12 / M18
Metal sleeve

0...10 V
4...20 mA



Design	M12x1	M18x1	M18x1
Dimensions			
Installation non flush (nf)			
Analog range [mm]	0...4 nf	0...5 nf	0...5 nf
Output			
ID-No.	4...20 mA P31128	0...10 V P31040	4...20 mA P31129
Type	IGA 104 GI	IGA 005 GU	IGA 005 GI
Supply voltage [V]	18...27 DC	18...27 DC	18...27 DC
Current consumption max. [mA]	40	25	40
Voltage output max. [V]	-	11	-
Output current max. [mA]	23	-	23
Linearity deviation [%]	10	5	5
Load resistance R _L [kΩ]	< 0.4	> 2	< 0.4
Ambient temperature [°C]		-25...+70	
Temperature deviation [%]		10	
Protection [EN 60529]		IP 67	
Housing material		Br-Ni / PBT	
Connecting	2 m PVC-cable 3x0.34 mm ²	2 m PVC-cable 3x0.5 mm ²	
Output signal with approaching iron plate ST37			
Connection diagram			



Analog output

Proximity sensors

M30
Ø 80 mm

0...10 V
4...20 mA



Design	M30x1.5		Ø 80 mm	
Dimensions				
Installation non flush (nf)				
Analog range [mm]	0...10 nf	0...10 nf	0...30 nf	0...30 nf
Output				
	0...10 V	4...20 mA	0...10 V	4...20 mA
ID-No.	P31041	P31130	P31043	P31131
Type	IGA 010 GU	IGA 010 GI	IDA 030 GU	IDA 030 GI
Supply voltage [V]	18...27 DC	18...27 DC	18...27 DC	18...27 DC
Current consumption max. [mA]	25	40	25	40
Voltage output max. [V]	11	-	11	-
Output current max. [mA]	-	23	-	23
Linearity deviation [%]	5			
Load resistance R _L [kΩ]	> 2	< 0.4	> 2	< 0.4
Ambient temperature [°C]	-25...+70			
Temperature deviation [%]	10			
Protection [EN 60529]	IP 67			
Housing material	Br-Ni / PBT		PBT	
Connection	2 m PVC-cable 3x0.5 mm ²			
Output signal with approaching iron plate ST37				
Connection diagram				



Analog | High temperature 160 °C

Proximity sensors

M18

4...20 mA

For the connection to amplifier IKM 120 GA

Permanent temperature 160 °C



Design	IGT 005	IKM 120 GA
Dimensions		
Installation	non flush (nf)	
Analog range [mm]	0...5 nf	-
ID-No.	P31143	P31144
Type	IGT 005	IKM 120 GA
Supply voltage [V]	-	24 DC ±20%
Current consumption [mA]	-	30
Current output [mA]	-	4...20 mA
Linearity [%]	6	0.5
Load R _L [Ω]	-	50...500
Ambient temperature [°C]	-25...+160	-20...+60
Temperature deviation [%]	10	2
Protection [EN 60529]	IP 67	IP 40
Housing material	AISI 316 Ti / PKS	PC
Connection	2 m PTFE 3x0.75 mm ²	terminal screws
Output signal with approaching iron plate ST37		
Connection diagramm		



Standard switches

Proximity switches

M8 / M12
Metal sleeve
DC 10...30 V
Euronorm



Design	M8x1	DC PNP • M12x1		DC PNP • M12x1	
Dimensions					
Installation flush (f) non flush (nf)					
Operating distance sn [mm]	1.5 f	2 f	4 nf	2 f	4 nf
Switching output PNP					
ID-No.	P31013	P31104	P31105	P31106	P31107
Type	IGM 1 GSP	IGM 102 GSP	IGM 104 GSP	IGMU 102 GSP	IGMU 104 GSP
Supply voltage [V]	10...30 DC	10...30 DC	10...30 DC	10...30 DC	10...30 DC
Switching current [mA]	200	200	200	200	200
Short circuit proof	•	•	•	•	•
Overcurrent release [mA]	250	250	250	250	250
Reverse protection	•	•	•	•	•
Voltage drop max. [V]	2	2	2	2	2
Residual current [mA]	-	-	-	-	-
Current consumption (not actuated) [mA]	< 11	< 5	< 5	< 5	< 5
Switching frequency [Hz]	1000	800	400	800	400
Ambient temperature [°C]	-25...+70	-25...+70	-25...+70	-25...+70	-25...+70
EMC-class	A	A	A	A	A
Protection [EN 60529]	IP 67	IP 67	IP 67	IP 67	IP 67
LED display	•	•	•	•	•
Housing material	Stainless steel / PA	Br-Ni / PPO	Br-Ni / PPO	Br-Ni / PPO	Br-Ni / PPO
Connection	2 m PVC-cable 3x0.14 mm ²	2 m PVC-cable 3x0.14 mm ²	2 m PVC-cable 3x0.14 mm ²	M12 connector	M12 connector
Accessories					

connecting cable SLG 3-2, page 3.69



Standard switches

Proximity switches

M18
Metal sleeve

DC 10...30 V

Euronorm



Design	DC PNP • M18x1		DC PNP • M18x1	
Dimensions				
Installation flush (f) non flush (nf)				
Operating distance sn [mm]	5 f	8 nf	5 f	8 nf
Switching output PNP				
ID-No.	P31110	P31111	P31112	P31113
Type	IGM 105 GSP	IGM 108 GSP	IGMU 105 GSP	IGMU 108 GSP
Supply voltage [V]	10...30 DC	10...30 DC	10...30 DC	10...30 DC
Switching current [mA]	200	200	200	200
Short circuit proof	•	•	•	•
Overcurrent release [mA]	250	250	250	250
Reverse protection	•	•	•	•
Voltage drop max. [V]	1.5	1.5	1.5	1.5
Residual current [mA]	-	-	-	-
Current consumption (not actuated) [mA]	1	1	1	1
Switching frequency [Hz]	500	200	500	200
Ambient temperature [°C]	-25...+70	-25...+70	-25...+70	-25...+70
EMC-class	A	A	A	A
Protection [EN 60529]	IP 67	IP 67	IP 67	IP 67
LED display	•	•	•	•
Housing material	Br-Ni / PPO	Br-Ni / PPO	Br-Ni / PPO	Br-Ni / PPO
Connection	2 m PVC-cable 3x0.5 mm ²	2 m PVC-cable 3x0.5 mm ²	M12 connector	M12 connector
Accessories				

connecting cable SLG 3-2, page 3.69



Standard switches

Proximity switches

Smooth-bodied switch

Ø 20 mm / Ø 34 mm

DC 10...55 V

Sensors for AC voltage are available on request



Design	DC PNP		DC PNP	
	Ø 20 mm	Ø 34 mm	Ø 20 mm	Ø 34 mm
			programmable	
Dimensions				
Installation non flush (nf)				
Operating distance sn [mm]	10 nf	20 nf	10 nf	20 nf
Switching output PNP				
ID-No.	P30159	P30166	P30158	P30165
Type	INK 010 GSP	INK 020 GSP	INKS 010 GPP	INKS 020 GPP
Supply voltage [V]	10...55 DC	10...55 DC	10...55 DC	10...55 DC
Switching current [mA]	400	400	400	400
Short circuit proof	•	•	•	•
Overcurrent release [mA]	450	450	450	450
Reverse protection	•	•	•	•
Voltage drop max. [V]	2	2	2	2
Residual current [mA]	-	-	-	-
Current consumption (not actuated) [mA]	2.5	2.5	2.5	2.5
Switching frequency [Hz]	1500	500	1500	500
Ambient temperature [°C]	-25...+75	-25...+75	-25...+75	-25...+75
EMC-class	A	A	A	A
Protection [EN 60529]	IP 67	IP 67	IP 67	IP 67
LED display	•	•	•	•
Housing material	PBT	PBT	PBT	PBT
Connection	2 m PVC-cable 3x0.5 mm ²	2 m PVC-cable 3x0.5 mm ²	2 m PVC-cable 3x0.5 mm ² (PG-plug connection)	2 m PVC-cable 3x0.5 mm ² (PG-plug connection)
PG-plug connection				
DC 1: BN 2: BU 3: BK				
Schalter / switch Disconnect power supply before pulling off plug connector. Spannungsversorgung abschalten bevor Steckverbindung gezogen wird.				
Accessories	mounting clamps Ø 20 mm (Z00100), Ø 34 mm (Z00102) are part of delivery			



Special functions | Surface sensor

Proximity switches

Wide detection range

DC 10...55 V

Sensitivity adjustable
Moisture-resistant
PG-plug IP 68

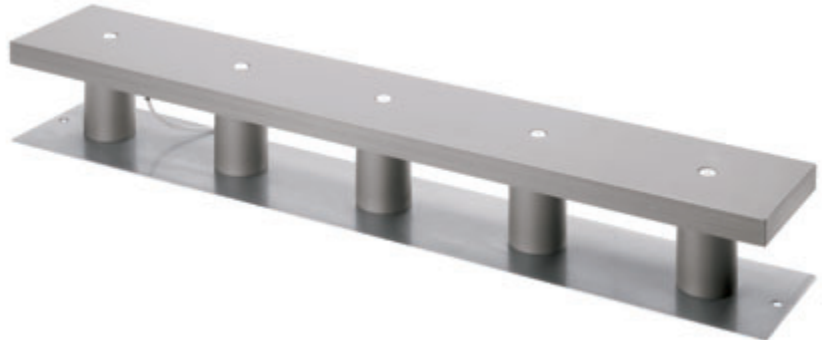

Design		DC PNP				
Dimensions						
Installation	non flush (nf)					
Operating distance sn [mm]	100 nf	100 nf	130 nf	150 nf	180 nf	
Adjustable range max.	120	150	170	200	250	
Switching output PNP						
ID-No.	P31016	P31018	P31020	P31022	P31024	
Type	IFE 200/100 GSP	IFE 400/100 GSP	IFE 400/150 GSP	IFE 700/150 GSP	IFE 900/150 GSP	
Dimensions	L	200	400	400	700	900
	B	100	100	150	150	150
	Si	108	280	230	190	182
Supply voltage [V]	10...55 DC					
Switching current [mA]	< 400					
Short circuit protection	•					
Overcurrent release approx. [mA]	430					
Reverse protection	•					
Current consumption approx. [mA]	4					
Inverse current max. [µA]	1					
Residual ripple max. [%]	15					
Voltage drop max. [V]	2					
Switching frequency [Hz]	10					
Hysteresis [%]	10					
Ambient temperature [°C]	-25...+75					
Correction factors	St 37: 1	AL: 0.4	VA 4: 0.65	Cu: 0.45	ZN: 0.5 MS: 0.6	
EMC-class	A					
Protection [EN 60529]	IP 68					
Housing material	PVC / Aluminium					
Connection	PG-plug connection, 2 m PVC-cable 3x0.5 mm ²					
Notes	see page 3.3					



Special functions | Offshore

Proximity switches

M12 / M18
Stainless steel sleeve

DC 10...30 V

High compressive strength
Longitudinal water blocked cable
Sea water proofed



Design	DC PNP • M12x1	DC PNP • M18x1
Dimensions		
Installation flush (f)		
Operating distance s_n [mm]	2 f	5 f
Switching output PNP		
ID-No.	P31223	P31224
Type	IGMO 02 GSP	IGMO 05 GSP
Supply voltage [V]	10...30 DC	
Switching current [mA]	200	
Short circuit proof	•	
Reverse protection	•	
Current consumption [mA]	4	
Switching frequency [Hz]	200	
Ambient temperature [°C]	-25...+70	
Compressive strength [bar]	30	
Protection [EN 60529]	IP 68	
Housing material	PTFE / AISI 316 Ti	
Sealing material	FKM	
Connection	1 m longitudinal water blocked cable	



Special functions | Offshore

Proximity switches

M18 / M30
One piece stainless steel housing

DC 10...30 V

High compressive strength
Longitudinal water blocked cable
Sea water proofe



Design	DC PNP • M18x1	DC PNP • M30x1.5
Dimensions		
Installation flush (f)		
Operating distance sn [mm]	5 b	10 b
Switching output PNP		
ID-No.	P31365	P31366
Type	IGVO 05 GSP	IGVO 10 GSP
Supply voltage [V]	10...30 DC	
Switching current [mA]	250	
Short circuit proof	•	
Reverse protection	•	
Current consumption max. [mA]	5	
Switching frequency [Hz]	180	150
Ambient temperature [°C]	-25...+70	
Compressive strength [bar]	30	
Protection [EN 60529]	IP 68 + IP 69	
EMC-class	A	
Housing material	AISI 316 L	
Sealing material	FKM	
Connection	1 m longitudinal water blocked cable PLWDC-cable 3x0.5 mm ²	



Special functions | Washing resistant

Proximity switches

DC 10...30 V

110 °C Permanent temperature
Resistant to hot steam
Resistant to detergents

IP 68 + IP 69



Design	DC PNP • Ø 80 mm	DC PNP • Ø 120 mm
Dimensions		
Installation non flush (nf)		
Operating distance sn [mm]	55 nf	90 nf
Switching output PNP		
ID-No.	P31214	P31177
Type	IDKW 080 GSP	IDKW 120 GSP
Supply voltage [V]	10...30 DC	
Switching current [mA]	300	
Hysteresis	< 0.1 Sn	
Voltage drop max. [V]	2	
Current consumption [mA]	10	
Switching frequency [Hz]	30	
Ambient temperature [°C]	-20...+110	
Limiting temperature [°C]	120	
Temperature deviation [%]	≤ 10	
EMC-class	A	
Protection [EN 60529]	IP 68 + IP 69	
Housing material	PP / AISI 316 Ti	
Sealing material	EPDM	
Connection	5 m FEP-cable 3x0.75 mm ² , shielded	
Switching current		



Special functions | Factor 1

Proximity switches

M30
 Ø 80 mm / Ø 160 mm

DC 10...30 V

Correction factor 1
 for all metals



Design	M30x1.5	M30x1.5	Ø 80 mm	Ø 160 mm
Dimensions				
Installation flush (f) non flush (nf) adjustable (a)				
Operating distance sn [mm]	10 f	20 nf	70 nf-a	150 nf-a
Switching output PNP				
ID-No.	P31135	P31136	P31141	P31142
Type	IGBS 010 GSP	IGBS 020 GSP	IDBS 080 GPP	IDBS 160 GPP
Supply voltage [V]	10...30 DC			
Switching current [mA]	200			
Short circuit proof	•			
Current consumption [mA]	25			
Reverse protection	•			
Voltage drop max. [V]	2			
Switching frequency [Hz]	300		20	
Ambient temperature [°C]	-25...+75			
EMC-class	A			
Protection [EN 60529]	IP 67			
Housing material	Br-Ni / PBT		PBT / Aluminium	
Connection	M12 connector		PG-plug connection 2 m, 3x0.5 mm ² PVC	
PG-plug-system				
<p>AC DC</p> <p>1: BN 1: BN</p> <p>2: BU 2: BU</p> <p>3: BK 3: BK</p> <p>Schalter / switch</p> <p>Disconnect power supply before pulling off plug connector. Spannungsversorgung abschalten bevor Steckverbindung gezogen wird.</p> <p>NO NC</p>				



Metal face sensor | Speed sensor | $-40...+150\text{ }^{\circ}\text{C}$

Proximity switches

Detection of ferromagnetic targets

One piece stainless steel housing

$-40...+150\text{ }^{\circ}\text{C}$

IP 68 Water-proofed

IP 69 Resistant to high pressure cleaning



Design	DC PNP • M18x1
<i>Dimensions</i>	
Operating distance sn [mm]	3
Switching output PNP	
ID-No.	P31364
Type	HGVB 03 GSP
Supply voltage [V]	10...30 DC
Switching current max. [mA]	100
Short circuit proof	•
Reverse protection	•
Voltage drop max. [V]	2.5
Current consumption max. [mA]	20
Switching frequency [Hz]	6000
Ambient temperature [°C]	$-40...+150$
EMC-class	A
Protection [EN 60529]	IP 68 + IP 69
Housing material	AISI 316 L
Connection	2 m FEP-cable 3x0.34 mm ²



Notes

