

RPW EL

Scale for electric pallet trucks and order pickers



BENEFITS

- Fits all trucks
- Only 5 mm increase in fork height
- Weight transfer to truck terminal (optional)
- Data transfer (optional to WMS or ERP systems)
- For check weighing and preventing errors in order picking

Top quality
Also for retrofit

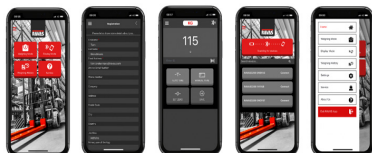

RAVAS

FUNCTIONS

- Functions of 3200, 5200, 6100, 2100 (Exi) or Touch weight indicator
- See relevant indicator specification sheet

The RAVAS indicators have been developed exclusively for mobile applications. They are robust and resistant to shocks and vibrations. RAVAS indicators are compact and have a low power consumption. All indicators are dust and waterproof, according to norm IP65. RAVAS mobile scales can be used outdoors and on freight trucks.

STANDARD SPECIFICATIONS

- Capacity same as lifting capacity of the truck
- Graduation Multirange 0,5/1kg till 500/Q-max
- Scale tolerance 0.1% of the load lifted
- Protection class load cells IP67, indicator IP65
- Power supply from truck battery

MODIFICATION OF THE TRUCK

All electric pallet trucks and order picking trucks can be equipped with the RPW EL scale. The fork construction of the truck is mechanically modified, in order to mount the scale components with only 5 mm of added fork height. A scale indicator of your choice shows the weight on the forks and communicates with a truck terminal or warehouse management system if desired.

DIMENSIONS AFTER MODIFICATION

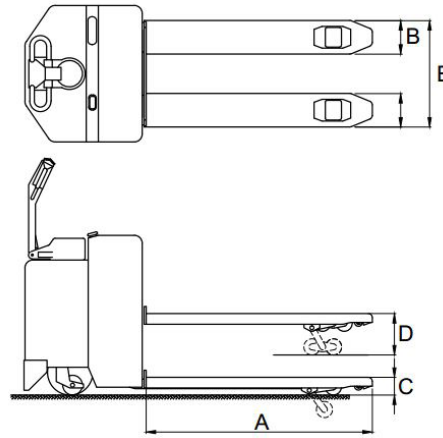

	Standard fork length	1150
A	Fork Length	+10
B	Fork width	+20
C	Minimum fork height	+5 mm
D	Maximum fork height	+5 mm
E	Width over the forks	+ 20
	Tollerances +/- 2 mm	



Management System
ISO 9001:2015
ISO 14001:2015
ISO 45001:2018
www.tuv.com
ID 000037200

OPTIONS*

- Thermal or matrix printer
- RS232, Bluetooth or WiFi output
- Legal for trade version, OIML III
- Smaller display graduations
- Different fork lengths and widths
- Fork adjustment for entering into closed pallets
- Stainless steel fork shoes
- Explosion proof version for use in hazardous areas, zone I; ATEX certified
- RDC, RAVAS Data Collector Software
- RIS, RAVAS Integration Software

RAVAS Europe B.V.

Veilingweg 17, 5301 KM Zaltbommel, The Netherlands

T: +31 418 515220 E: salesoffice@ravas.com

WWW.RAVAS.COM

