

FARSTRUP

CONTRACT®



SHIP SINCE 1910 · FARSTRUP



Farstrup har bygget stole siden 1918

Hos Farstrup Furniture håndbygger vi kvalitetsmøbler - skabt af mennesker til mennesker. I mere end 110 år har vi produceret møbler af nøje udvalgte organiske materialer, der forarbejdes af passionerede håndværkere med kærlighed til træ og sans for detaljen.

Vores håndværkere, udviklere og designere arbejder tæt sammen gennem hele processen når en stol udvikles fra stamme til stue. Det sikrer, at vores møbler altid bliver skabt med en særlig respekt for unikke behov, miljø og bæredygtighed.

Fælles for alle møblerne er et grundlæggende princip om kompromisløs kvalitet, hvor materialer og håndværk forenes med design og siddekomfort.

Farstrup Furnitures historie går helt tilbage til 1910.

Dengang startede virksomheden som et savværk. Siden da har vi raffineret teknikken og fremstillet millioner af stole i bedste kvalitet.

Håndværk

Hos os er høj kvalitet ikke en valgmulighed men en forudsætning. Vi brænder for fordybelsen og ansvarligheden ved at følge stolen tæt gennem hele processen fra træudskæring til pudning, lakering, polstring og samling. Når det kommer til forståelsen for et ædelt materiale som træ, kan ingen maskiner hamle op med vores håndværkeres vågne øjne og erfarne hænder.

Individuelle muligheder

Vi mennesker er ikke ens og har alle forskellige behov. Derfor har vi hos Farstrup Furniture specialiseret os i at skræddersy kvalitetsstole efter individuelle ønsker og behov.

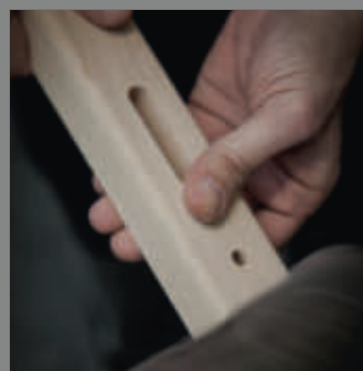
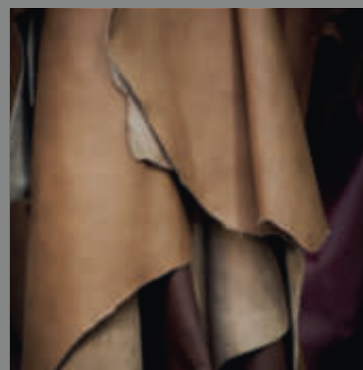

Indholdsfortegnelse

Munin	side 4
Tray-sit	side 6
Bear	side 10
Stag	side 12
Woom	side 18
Nobel	side 20
Plus	side 32
Multiplus	side 40
Plus sofaserie	side 42
Edge	side 44
Cantate	side 46
Scala	side 50
Senator	side 54
Home-line	side 60
No. 210r	side 64
Classic	side 66
Fastoflex	side 68
4000 Elegant-T bord	side 76
3900 Care-T bord	side 78
3800 Classic-T bord	side 80
3800 Sofabord	side 82
Multibord	side 84
Mål & specifikationer	side 86

MUNIN



Munin
Design: Lise Vester

Munin er designet til at give en unik siddeoplevelse samtidig med, at den er sansestimulerende.

Munin afskærmer for rumstøj, giver mulighed for fordybelse og afspænding til de beroligende gyng bevægelser. Fås også uden glidesystem.

MUNIN

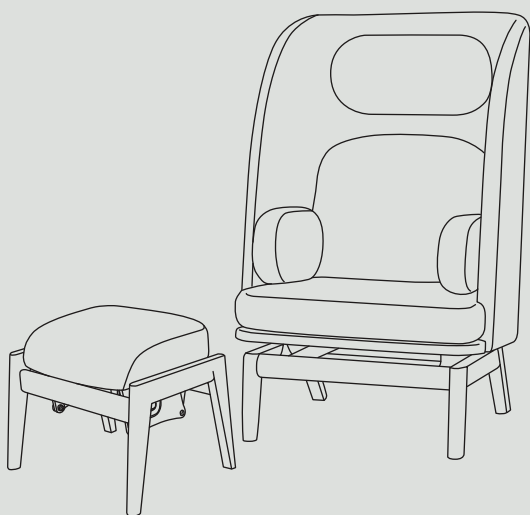

TRAY-SIT®





TRAY-SIT®



Tray-Sit® er et enkelt og genialt multimøbel i massivt egetræ med en hvid og sort softlaminatbakke. Tray-Sit® er både et bord, en taburet, fodskammel og en severingsbakke i samme møbel.

TRAY-SIT®

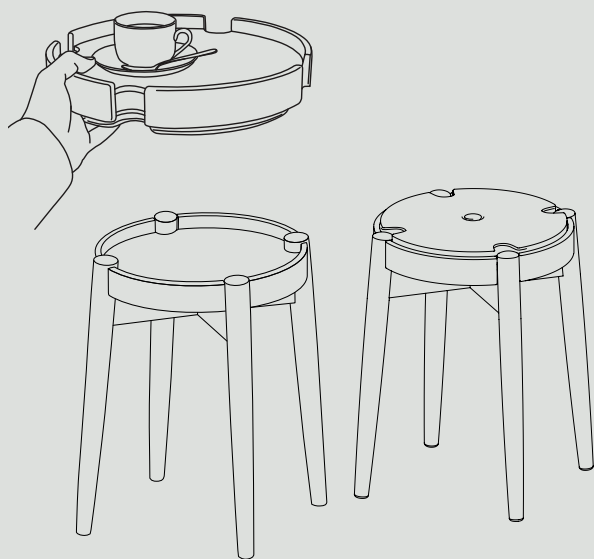

BEAR



Bear Recliner
Design: Erik Simonsen mDD & Justus Kolberg

Bear er et statement af en møbelserie, som består af en loungestol, en recliner samt en tilhørende skammel, Cub. Bear er nyt og samtidig klassisk møbeldesign, der signalerer overskud, styrke og stilsikker kvalitet.

BEAR

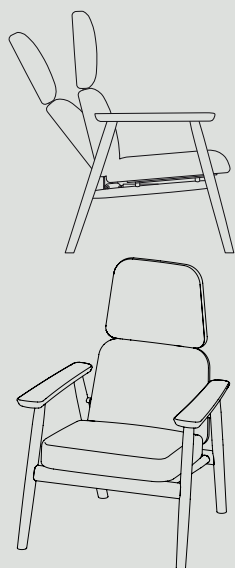

STAG





STAG-S



Stag-Steel. Elegant designstol i krom eller sortlakeret stel, som giver et let og elegant indtryk. Her kan man vælge mellem træsæde eller en eksklusiv polstring med læder eller kvalitetsstof. Den rummelige Stag passer ind i alle miljøer, ved møde- eller spisebordet; i restauranten eller i konferencelokalet.

STAG



STAG-W



Stag-W_{od}. Stilren og elegant designstol, der signalerer dansk møbelhåndværk og gedigen kvalitet. Rygraden i Stag er et smukt formspændt sæde i ege- eller bøgefinér.

Den stabelbare Stag har overlegen siddekomfort og de organiske og eksklusive dampbøjede signaturarmræn gør den behagelig at komme op af.

STAG

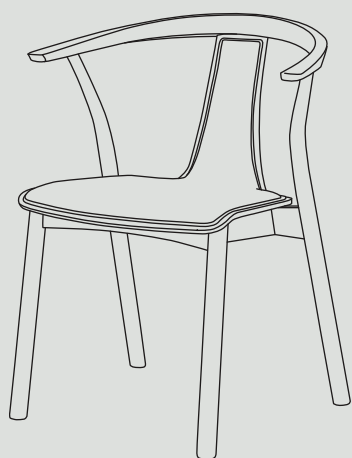

WOOOM

Woom er en designstol til loungen, de åbne kontorer eller til stuen. Læselys, sædevarme og massage er optioner og gør stolen til det perfekte sted at fordybe sig i arbejde eller bare at slappe af. Den formstøbte filt er fremstillet af genbrugsmaterialer og gør stolen til et bæredygtigt valg.

WOOOM

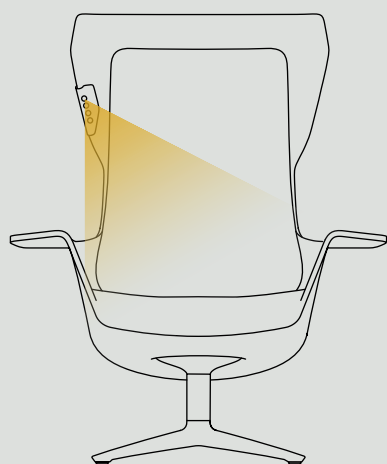

Læselys

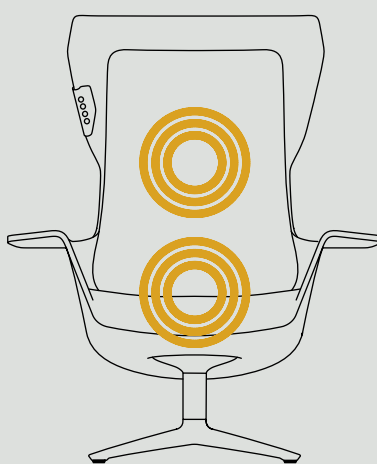

Sædevarme

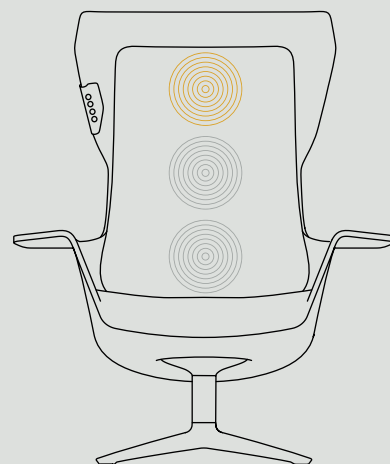

Massage



NOBEL



NOBEL



Nobel giver med sin høje slanke ryg både god siddekomfort og et stilrent udtryk. De smukt forarbejdede detaljer i stolens armlæn og forben signalerer ædelt håndværk og repræsenterer samtidig det bedste af tidløst dansk design.

NOBEL

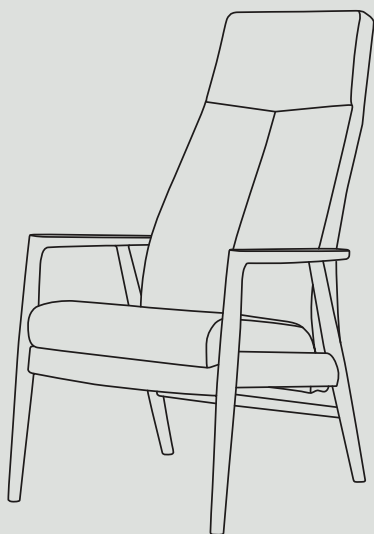

NOBEL



Nobel
Design: Ole Tornøe Olesen

Her er lagt maksimalt fokus på glæden ved at sidde godt. Trinløs justering af hvilepositionen og armlæn med et godt greb gør Nobel velegnet til en lang siddepause. Nobel stolen med øreklapper giver et solidt og betryggende indtryk.

NOBEL

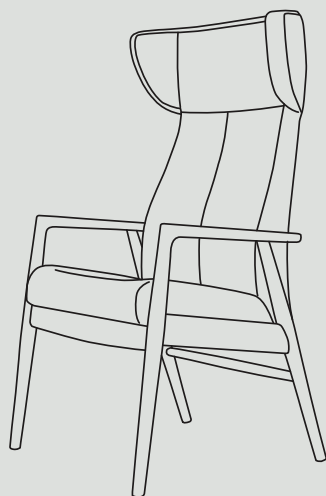

NOBEL



Nobel-gyngestolens ranke ryg er designet med mulighed for trinløs regulering med det udvendige låsegreb i messing. Gyngestolens rolige og vuggende bevægelser er afslappende og skaber ro for brugeren. Gyngestolen kan fås både med og uden øreklapper.

NOBEL

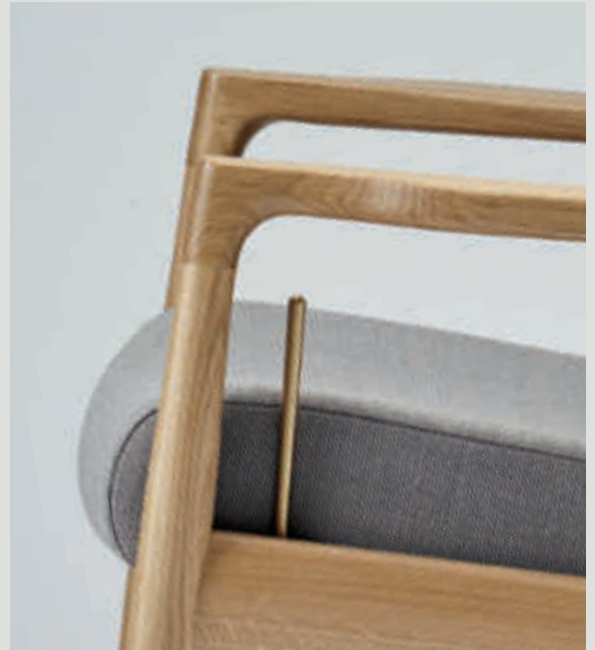
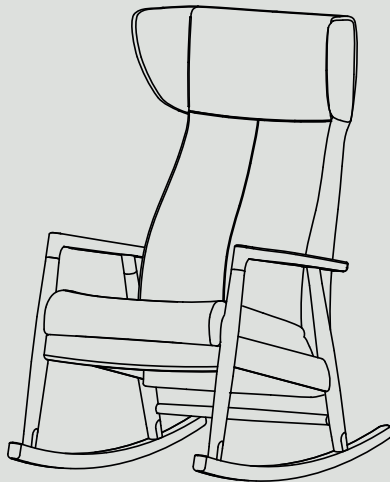

NOBEL



Nobel sofaserien skaber en hyggelig og rar stemning med sine organiske former. Serien er kendetegnet ved et ædelt og elegant udtryk, hvor der er kælet for detaljerne, uden at gå på kompromis med komforten. Sofaserien består af en 2½ personers sofa samt den matchende sofastol.

NOBEL

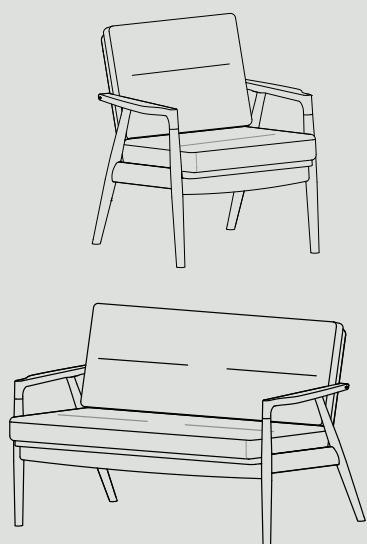

NOBEL



Nobel stabel- og spisebordsstol er en smuk og elegant stol med fokus på enkelthed og materialer i bedste kvalitet - her er der kælet for detaljen. Træets årer står smukt frem i de sammenpudsede armlæn. Den stabelbare Nobel kan fås med og uden polstring.

NOBEL

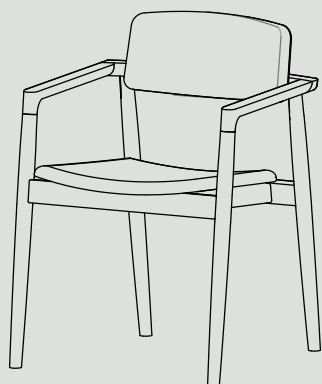

PLUS



PLUS



Plus, solidt møbelhåndværk i et organisk udtryk. Plus er en alsidig serie, fra den behagelige lænestol i stuen til den fuldt udrustede funktionsstol med sædeløft og hjul til hospitalet eller plejehjemmet. Samme smukke træstel med forskellige polstringer og funktioner. De forskellige rygge giver stolen hvert sit udtryk, der signalerer hjemlighed.

PLUS

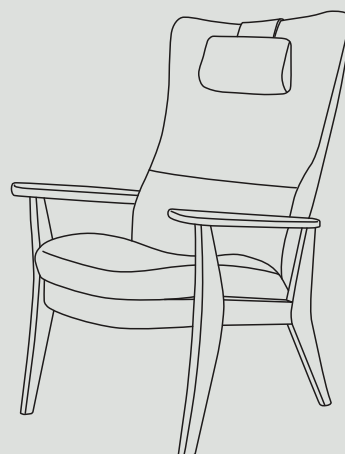

PLUS



Plus med ekstra funktioner letter hverdagen for både brugere og personale. Der er mange muligheder med de populære og stilrene Plusmodeller. Plus fås også med indbyggede motorer og sædeløft samt tilbehør, der omfatter låsegreb, armbakker, lukkede sider og hjul.

Manuelt eller elektronisk sædeløft giver brugeren hjælp til at komme op af stolen. Hvor det manuelle sædeløft er betinget af, at brugeren selv kan begynde udstigning fra stolen kan det elektroniske løfte brugeren op.

PLUS

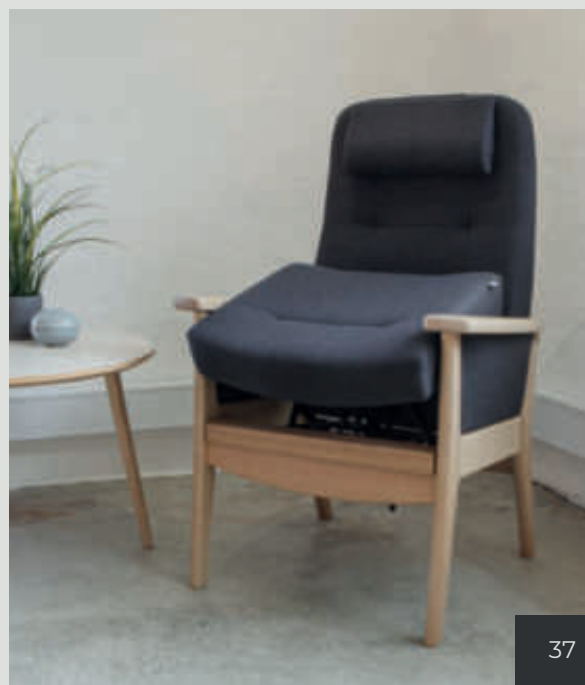
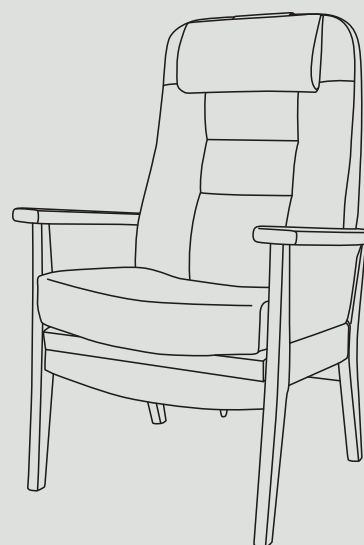





MULTIPLUS



Multiplus er en elektronisk funktionsstol med sædeløft og indbygget fodhviler.

Ryggen er ligeledes elektronisk. Den brugervenlige håndbetjening gør det let for brugeren eller personalet at anvende stolen.

Bemærk at armlænene går med op ved sædeløft, det giver ekstra støtte og tryghed.

MULTIPLUS

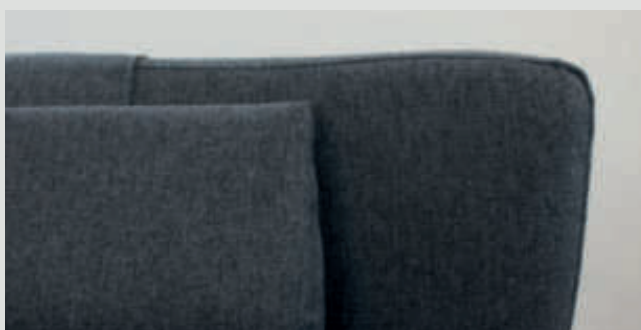
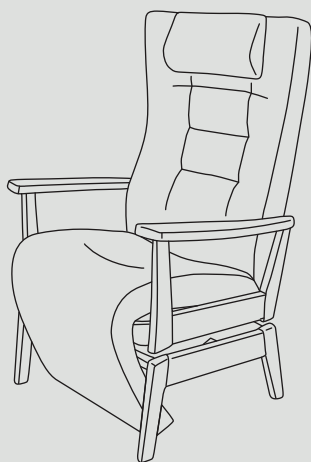

PLUS SOFASERIE



Sofagruppe og hvilestol i samme tidløse design. Plusserien giver helhed og sammenhæng i indretningen. Højden og udformningen på de brede armlæn gør møblerne lette at komme op af og ned i.

PLUS SOFASERIE

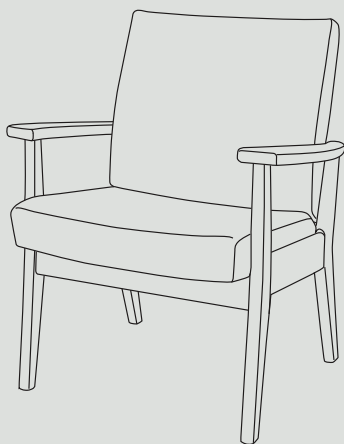

EDGE



Edge, stilrent design og god komfort.
Den skarpe udformning passer godt
ind i moderne miljøer.

EDGE



CANTATE





CANTATE



Cantate
Design: Hans J. Frydendal, MDD

Cantate tilbyder både siddekomfort og snedkerhåndværk i særklasse med de synlige fingertapninger. Stolen er blød, indbydende og samtidig en fryd for øjet.

CANTATE

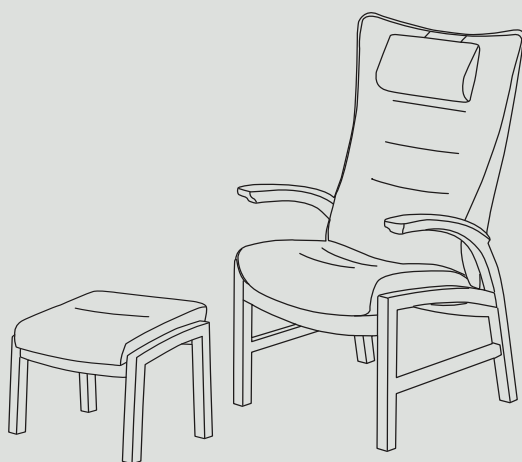

SCALA



Scala
Design: FF Design

Scala, klassisk stoledesign med armlæn i håndlavede fingersamlinger, som giver stolen sit særpræg og signalerer eksklusivitet.

SCALA

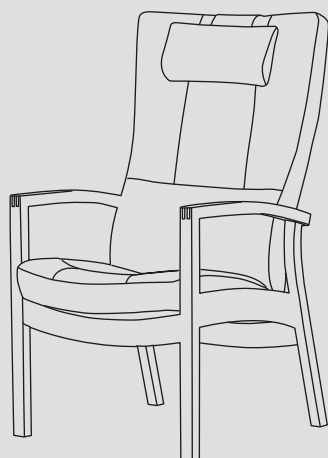

SCALA



Scala er en smuk og tidløs stol. Stolen er stabelbar, alsidig og kan anvendes i rigtig mange rum. Scala passer på kontoret, i stuen, konferencen og omkring spisebordet.

SCALA

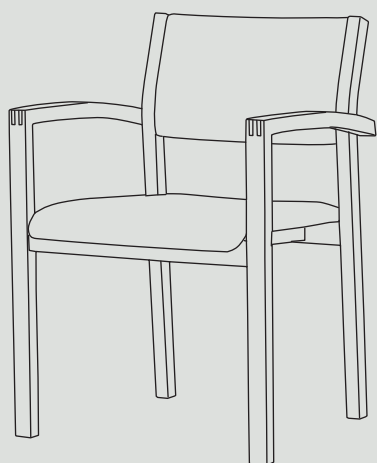

SENATOR



Senator er en klassisk og enkel stoleserie, der med sit lette look egner sig særdeles godt til plejesektoren. Den har en bred anvendelighed, funktion og de få syninger sikrer, at hygiejnekravene også er opfyldt. Senatorserien består af hvilestole og sofaer til opholdsstuen samt funktionsstole til patienter, pårørende og beboere.

SENATOR

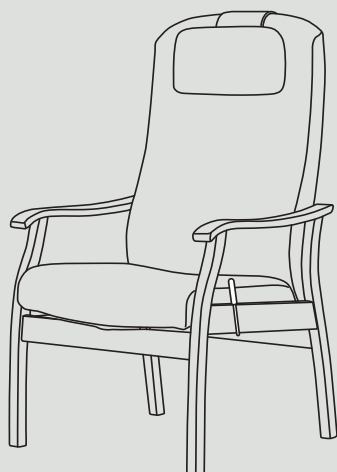

SENATOR



Funktionsstolene i Senator-serien er klassiske og enkle med vægt på ergonomi og komfort. Designet er klassisk og med det brede tilbehørsprogram kan stolene opfylde de fleste krav, der stilles i plejesektoren, på vagtstuer eller hospitaler. Med indbygget fodhviler, en eller to motorer eller monterede hjul er anvendeligheden mangfoldig for både brugere og personale.

SENATOR

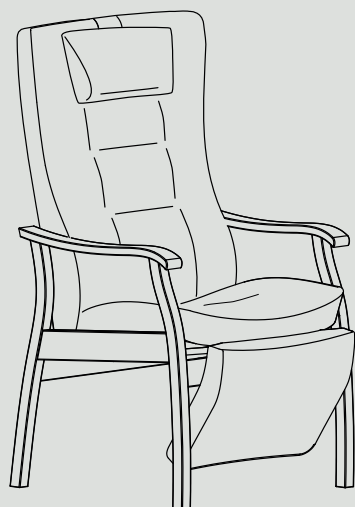

SENATOR



Senator er også en klassisk og enkel serie af stabelbare stole, der med sit lette look egner sig særdeles godt til flere sektorer. Plejesektoren – hvor der stilles store krav til funktion og hygiejne, eller som møde-/konferencestol, i kantiner eller venteværelser.

SENATOR

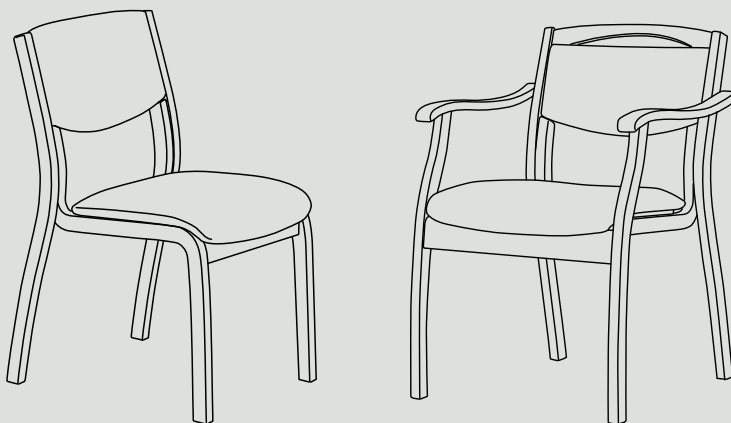

HOME-LINE



Home-Line hvile- og funktionsstol med faste eller justerbare armlæn. Stolen kan med en lang række tilbehørsmuligheder og funktioner tilpasses både patientbehov og plejepersonalets ønsker.

HOME-LINE

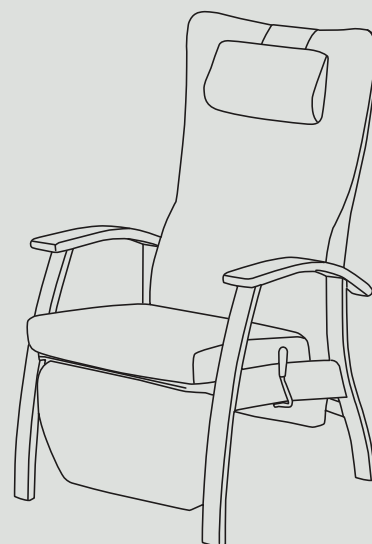

HOME-LINE



Home-Line med de mange indbyggede funktioner og finesser imødekommer også de skærpede krav til hygiejne og det sunde arbejdsmiljø for plejepersonalet.

I tæt samarbejde med det "Det Nye Hospital i Vest" – Gødstrup har Farstrup Furniture udviklet en helt speciel udgave af Home-Line stolen, hvor disse krav og patientkomforten er opfyldt.

HOME-LINE

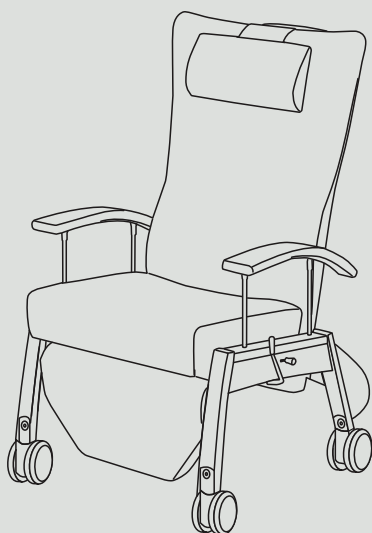

NO. 210R



Arkitekt Th. Harlevs klassiske No. 210r er smukt udformet og giver med sin karakteristiske ryg en optimal siddekomfort. Træstellet er konstrueret efter de gode danske snedkertraditioner og stolen er stadig ligeså smuk og solid som dengang i 1950'erne.

NO. 210R

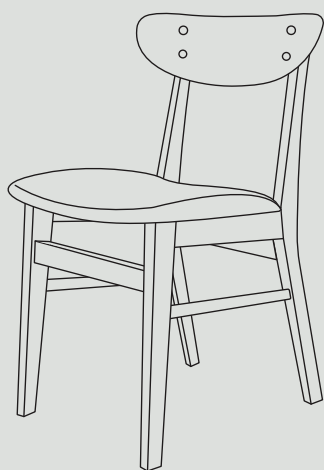

CLASSIC



Godt håndværk og enkelt design giver arm- og gyngestolen skønhed og unik form. Classic-stolene er ægte designklassikere, der aldrig går af mode.

Fremstillet i bøg med hynde i kvalitetsskum og valgfrit stof eller læder.

CLASSIC

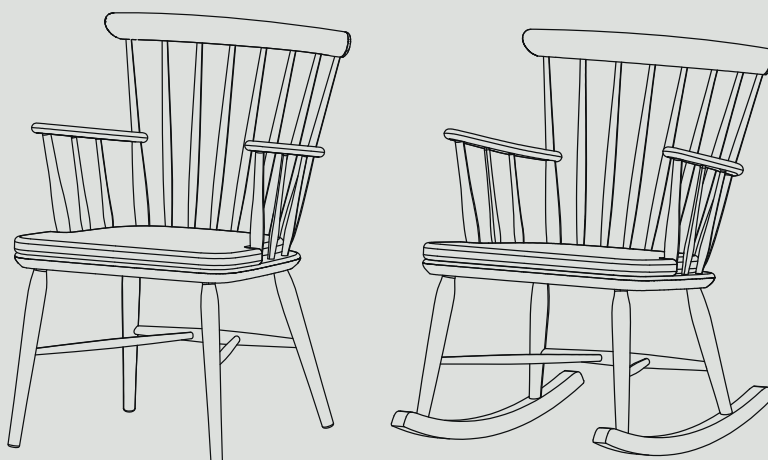

FASTOFLEX



Fastoflex er en stabelbar konference-, kantine- eller mødestol, som fås med eller uden armlæn. Stolen repræsenterer en gennemtænkt konstruktion, holdbarhed og overlegen siddekomfort, der gør Fastoflex til en moderne og tidløs klassiker.

FASTOFLEX

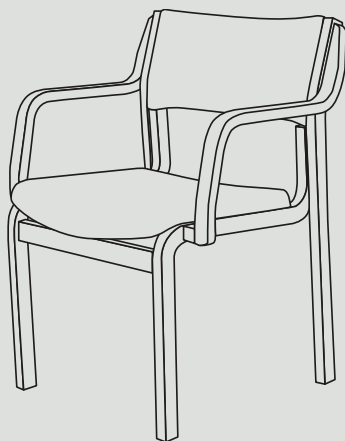

FASTOFLEX



Fastoflex er stabelstole, der kombinerer det praktiske med det elegante. Stolene er meget enkle at stable og fås i mange forskellige varianter, der gør dem anvendelige i både mindre lokaler og store sale.

FASTOFLEX

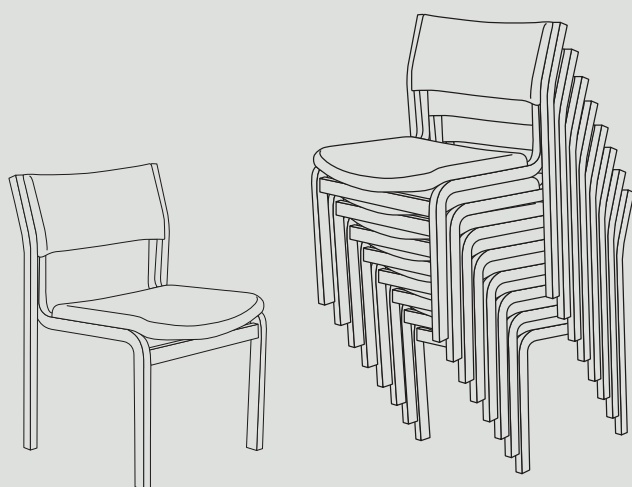

FASTOFLEX



Fastoflex 5463-B er en ekstra bred og holdbar stol, der giver maksimal siddekomfort for store mennesker. Stolen er et bariatrisk møbel, der med sit klassiske design passer ind mange steder. Fastoflex-B er testet op til 450 kg.

FASTOFLEX

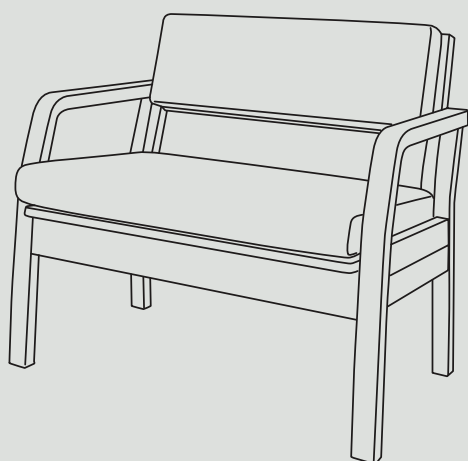

BORDE





4000
ELEGANT-T BORD



4000 Elegant Table er et stilrent spisebord i nordisk design. Bordet har afrundede kanter og krydsfinér bordplade med lakeret kantfinér. Bordbenene er koniske og skrånstillede og fås i egetræ med sort eller hvidt metalbeslag øverst.

4000 ELEGANT-T BORD

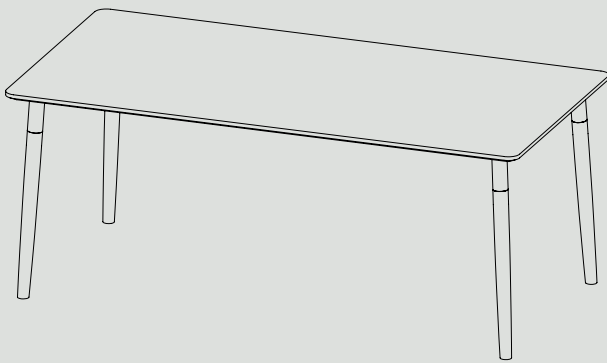

3900 CARE-T BORD



3900 er et klassisk og stilrent spisebord, i krydsfinérbordplade og ligestillede ege- eller bøgetræsben. Med sit stilrene look passer bordet ind i de fleste indretninger og kan kombineres med de fleste stole.

3900 CARE-T BORD



3800
CLASSIC-T BORD



Klassisk, enkelt og stilrent spisebord med lamineret bordplade samt ben og kantliste i enten ege- eller bøgetræ. Bordet laves i mange dimensioner og passer ind i alle miljøer og indretninger.

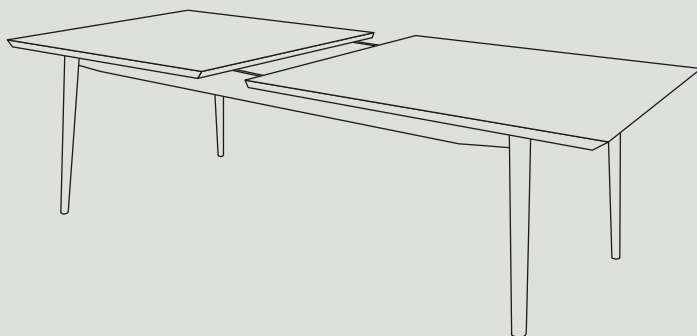
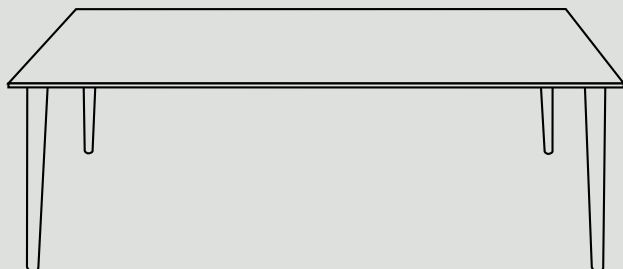
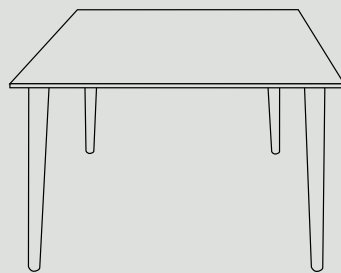

3800 Easy med integrerede tillægsplader. Bordpladen leveres i forskellige laminatoverflader. Fås med integrerede hjul i to ben.

3800 CLASSIC-T UDTRÆKSBORD



3800 SOFABORD



Sofabord med bordben i massivt ege- eller bøgetræ. Flot sofabord i moderne nordisk design, der passer ind i ethvert opholdsrum. Bordet fås i forskellige størrelser og højder.

3800 SOFABORD

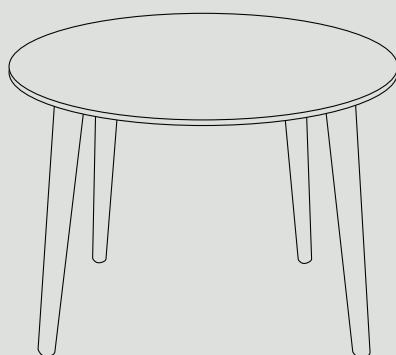

MULTIBORD



Multibordet giver god fleksibilitet for både bruger og plejepersonale. Bordet er fremstillet i bøg, med en bordplade i enten bøg eller hvid laminat, og har bremsbare hjul.

MULTI BORD

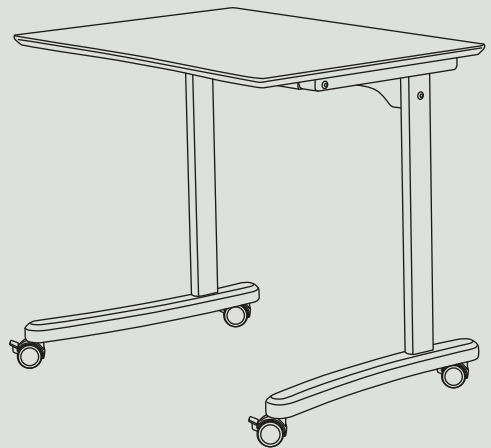

MÅL & SPECIFIKATIONER

På de følgende sider kan du finde alle mål og variationer på
4 5 samtlige modeller der findes i denne brochure. 14 15 16 17 18 19 20 21 22

Munin

Side 4

Design:
Lise Vester

Standard
sædehøjde:
47 cm.

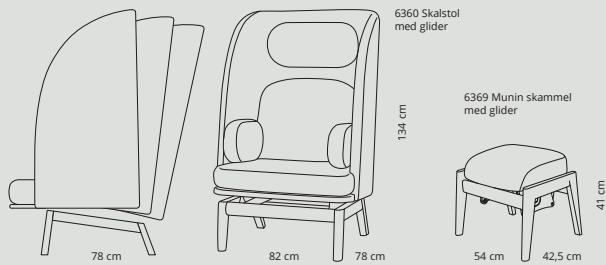

Tray-sit

Side 6

Design:
Erik Simonsen mDD
& Justus Kolberg

Sædehøjde:
49 cm.

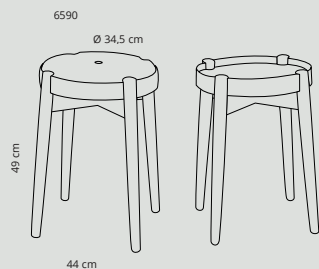

Bear

Side 10

Design:
Erik Simonsen mDD
& Justus Kolberg

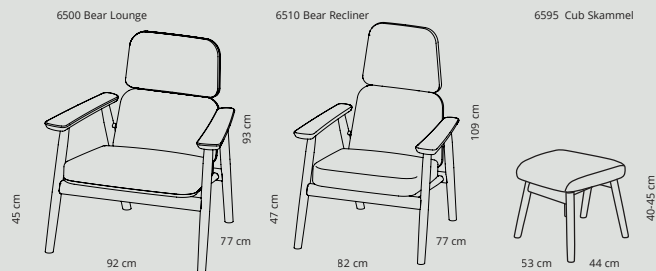

Stag-W

Side 12

Design:
Erik Simonsen mDD
& Justus Kolberg

Standard
sædehøjde:
45 cm.

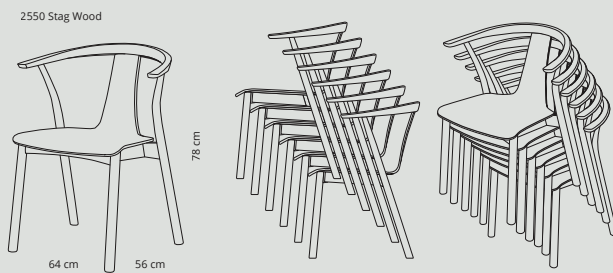

Stag-S

Side 14

Design:
Erik Simonsen mDD
& Justus Kolberg

Standard
sædehøjde:
45 cm.

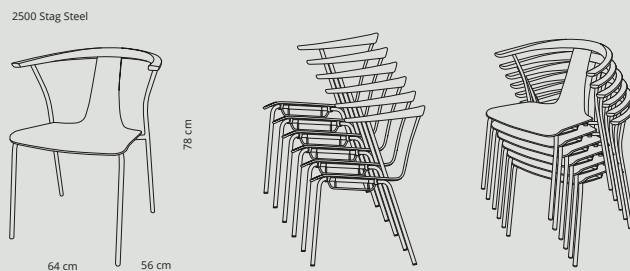

Woom

Side 18

Design:
Jörg Barnauer

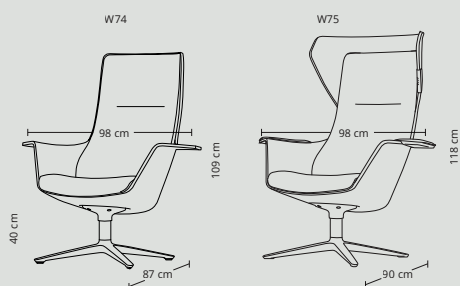

Nobel

Side 22

Design:
Ole Tørnøe Olesen

Standard
sædehøjde:
47 cm.

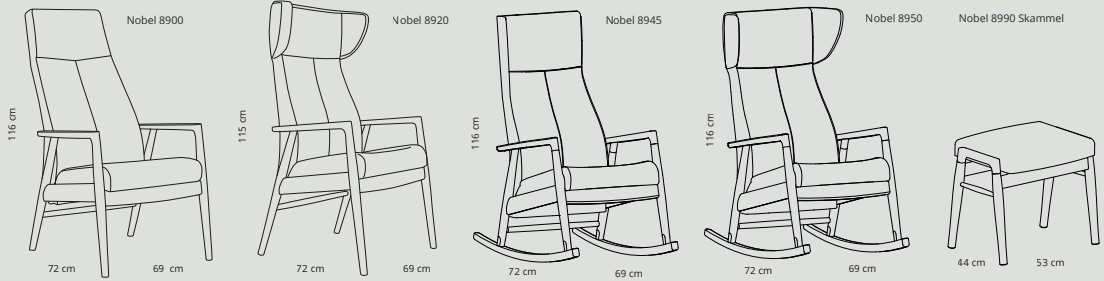

Nobel

Side 30

Design:
Ole Tørnøe Olesen

Standard
sædehøjde:
44 cm.

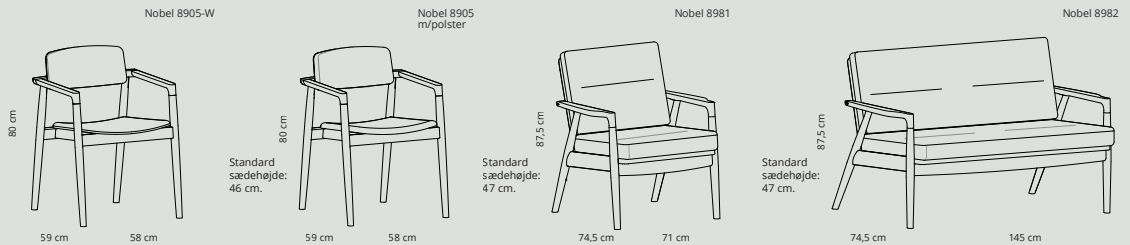

Plus

Side 32

Design:
Hans J. Frydendal, MDD

Standard
sædehøjde:
47 cm.

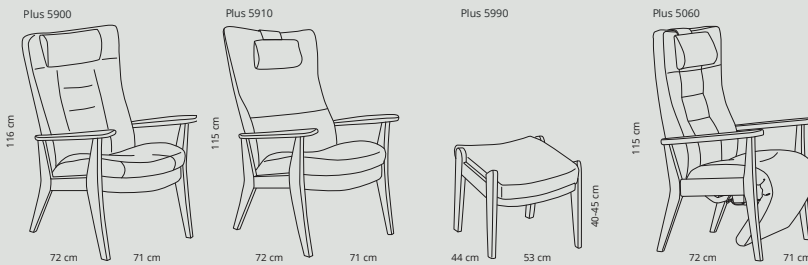

Multi-plus

Side 40

Design:
Hans J. Frydendal, MDD

Standard
sædehøjde:
47 cm.

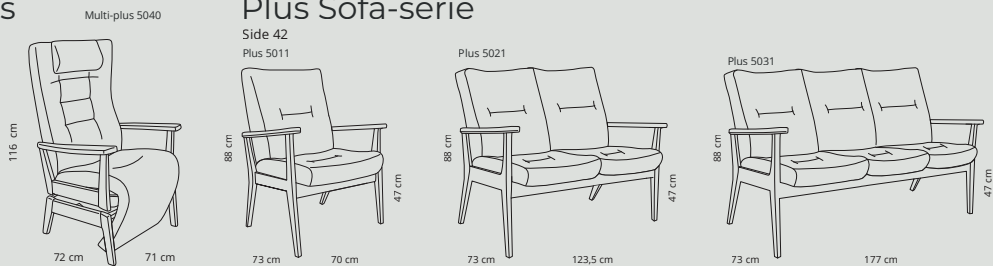

Plus Sofa-serie

Side 42

Plus 5011

Plus 5021

Plus 5031

Edge

Side 44

Design:
FF Design

Standard
sædehøjde:
47 cm.

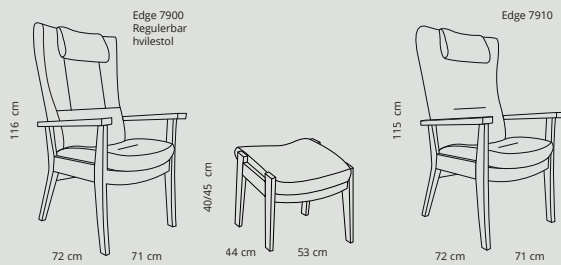

Cantate

Side 48

Design:
FF Design

Standard
sædehøjde:
47 cm.

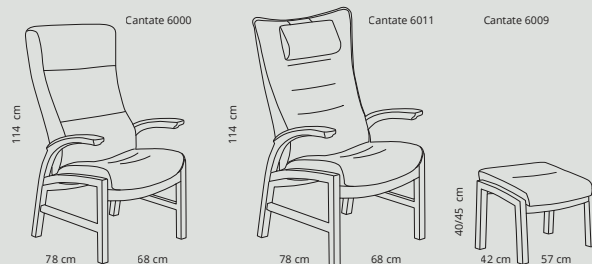

Scala

Side 50

Design:
FF Design

Standard
sædehøjde:
47 cm.

Scala 6411



Scala 5490

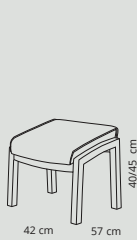

Scala 5411

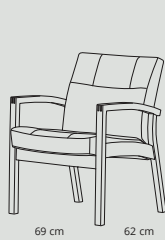

Scala 5412

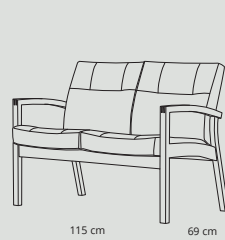

Scala 5413

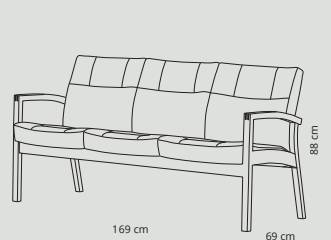

Scala stabelstol

Side 52

Design:
FF Design

Standard
sædehøjde:
46 cm.

Scala 2410

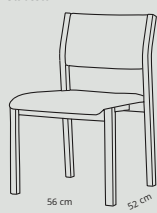

Scala 2411

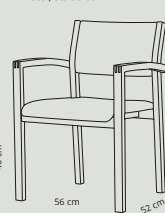

Scala 2419



Scala 2410

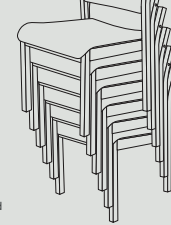

Scala 2411

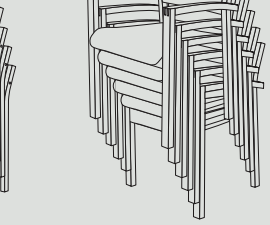

Bredde med
armlåen

Senator

Side 54

Design:
Reno Wahl Iversen

Standard
sædehøjde:
48 cm.

43/47 cm



Senator 5390

Hvilestol høj
regulerbar m.
udvendig
læsegreb

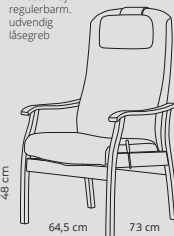

Senator 5371

Lav hvilestol

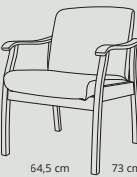

Senator 5372

Sofa 2 pers.

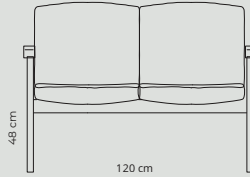

Senator 5373

Sofa 3 pers.

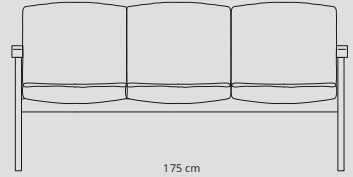

Senator

Side 56

Design:
Reno Wahl Iversen

Standard
sædehøjde:
47 cm.

Senator 5362

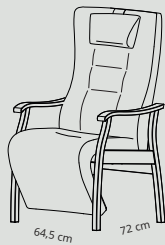

Senator 5364

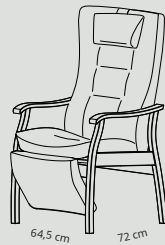

Senator

Side 58

Design:
Reno Wahl Iversen

Standard
sædehøjde:
45 cm.

45 cm



Senator 2341

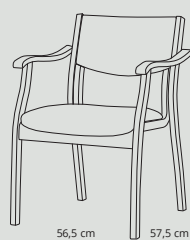

Senator 2348

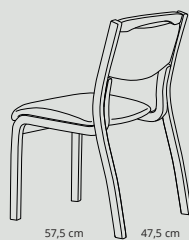

Senator 2349

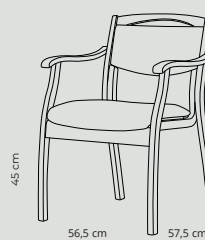

Home-line

Side 60

Design:
FF Design

Standard
sædehøjde:
47 cm.

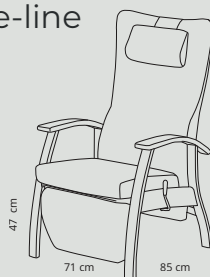

6311 Regulerbar
hvilestol m. indbygget
fodhviler

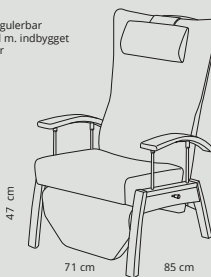

6341 Regulerbar
hvilestol m. justér-
bar arm

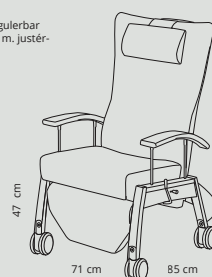

No. 210r

Side 64

Design:
Ark. Th. Harlev

Standard
sædehøjde:
47 cm.

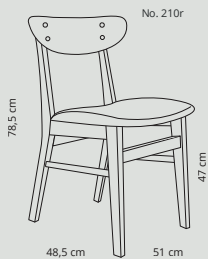

Classic

Side 66

Design:
Ark. Th. Harlev

Standard
sædehøjde:
47 cm.

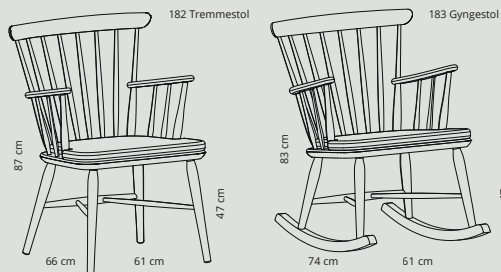

Fastoflex

Side 68

Design:
Reno Wahl Iversen

Standard
sædehøjde:
47 cm.

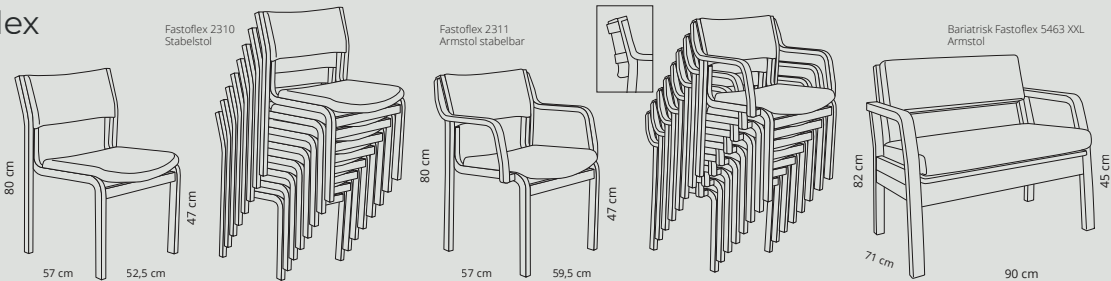

4000 Elegant-T borde

Side 76

Design:
FF Design

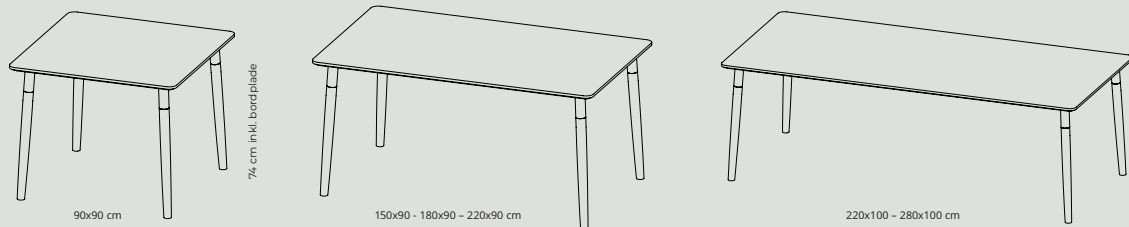

3900 Care-T borde

Side 78

Design:
FF Design

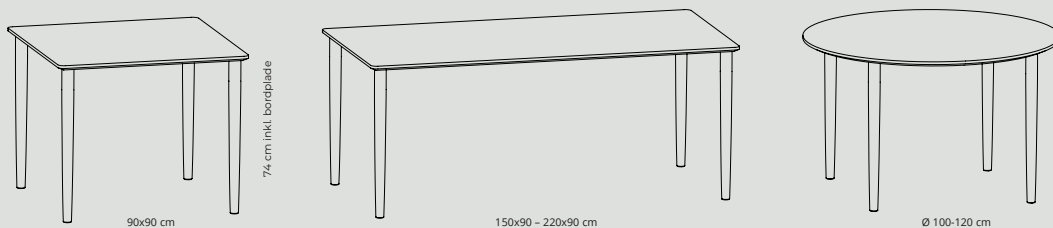

3800 Classic-T borde

Side 80

Design:
FF Design

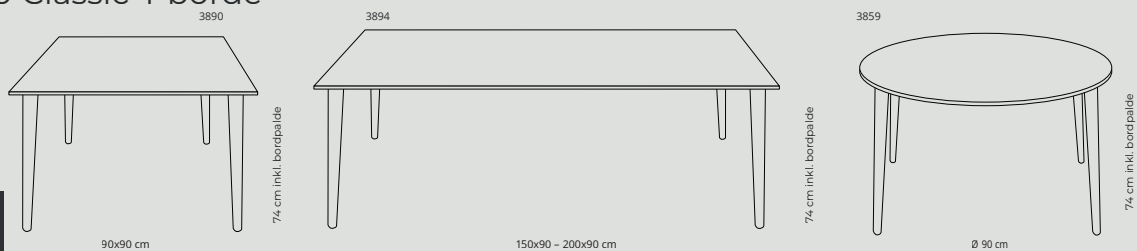

3800 Classic-T udtræksborde

Side 81

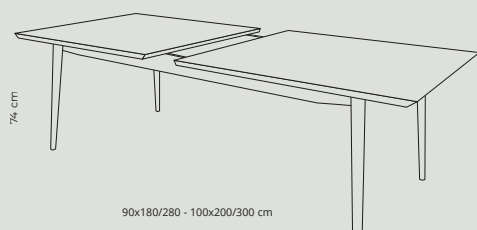

3800 Sofaborde

Side 82

Design:
FF Design



Multibord 4604

Side 84

Design:
FF Design

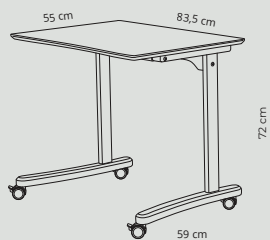



Besøg os på farstrup.dk eller på vores fabrik nær Odense

Farstrupvej 21 · DK-5471 Søndersø
Tel: + 45 6383 8383