

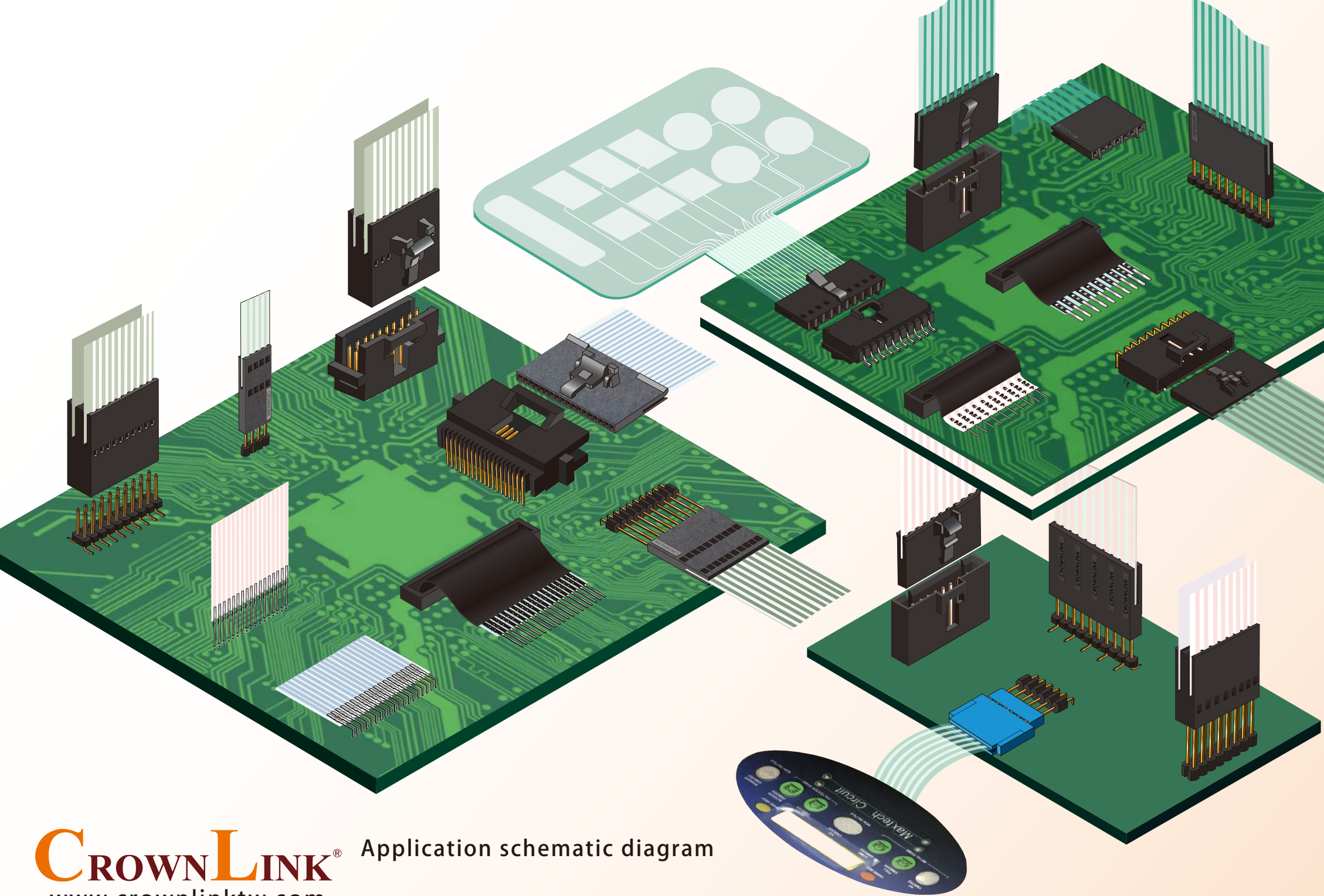

# CROWN LINK®



**CROWN LINK**<sup>®</sup>  
www.crownlinktw.com

Application schematic diagram

# 1.27mm Pitch

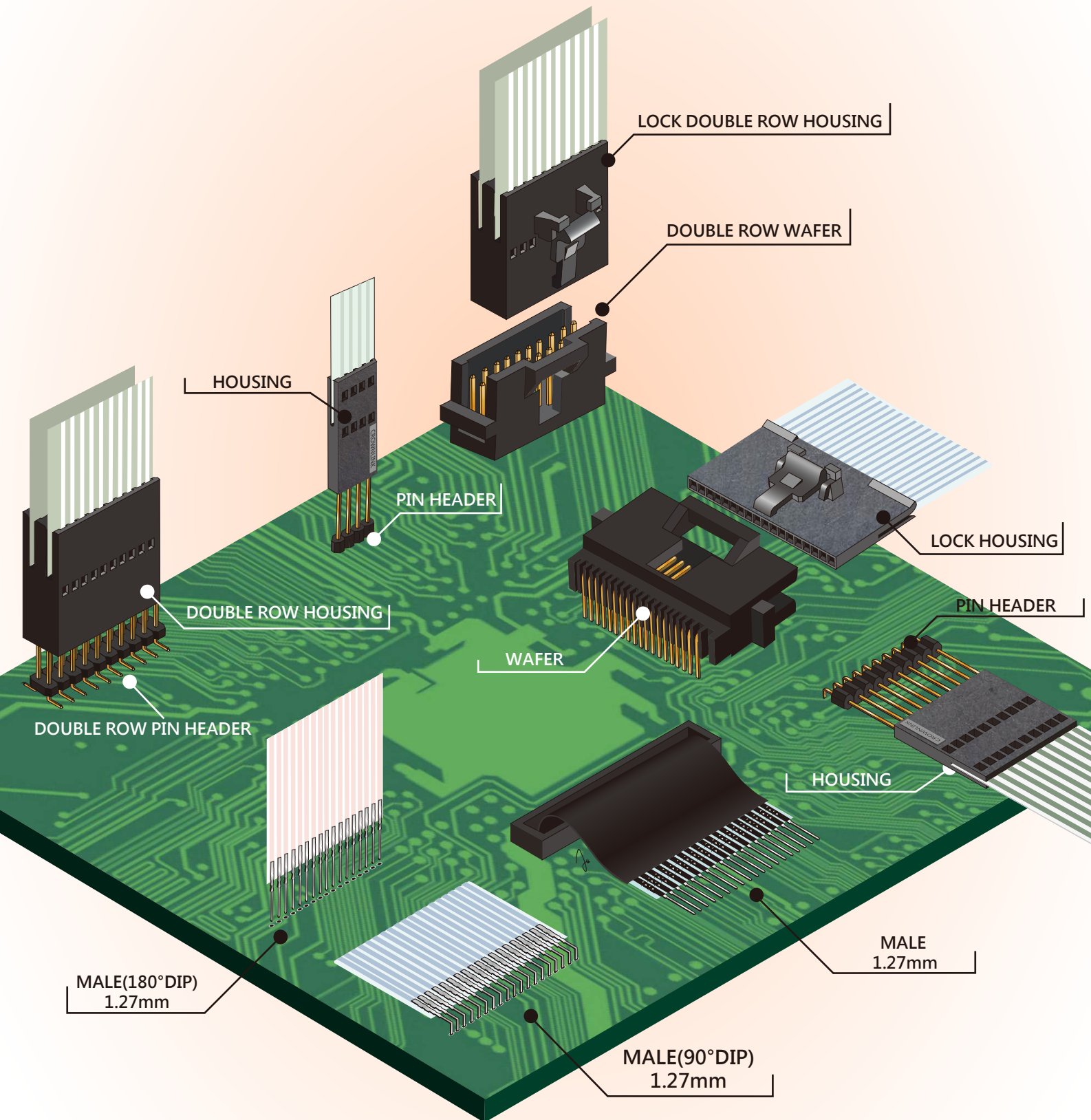



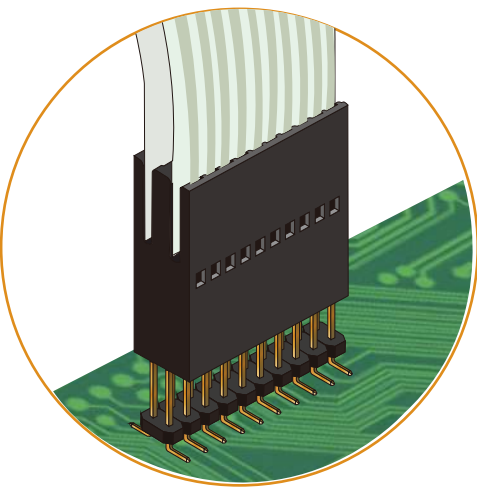

1.27mm

1.27mm

DOUBLE ROW PIN HEADER  
1.27mm PCB

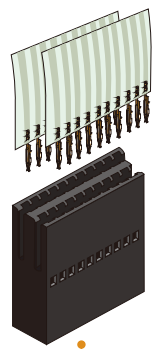

2807-30K-0T(0G)-F

2807H-XXDNH  
(08~100PIN)

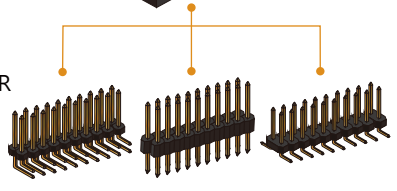

90° DIP  
180° DIP  
SMT

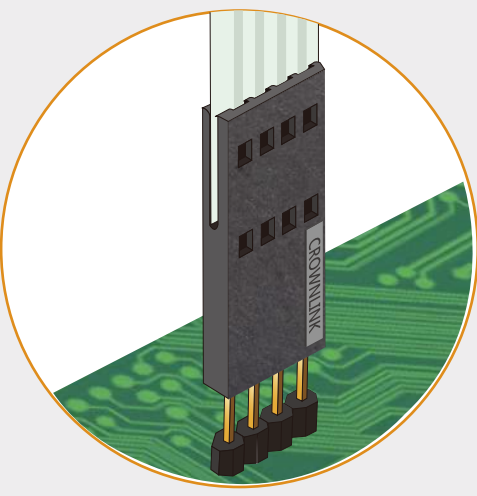

1.27mm

1.27mm

PIN HEADER  
1.27mm PCB



2807-30K-0T(0G)-F

2807H-XX (02~30PIN)

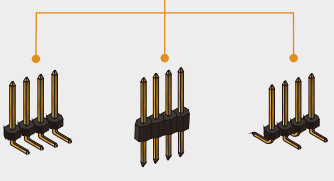

L203XX-XX1XXXXX(90°DIP)  
L203XX-XX0XXXXX(180°DIP)  
L205XX-XX2XXXXX(SMT)

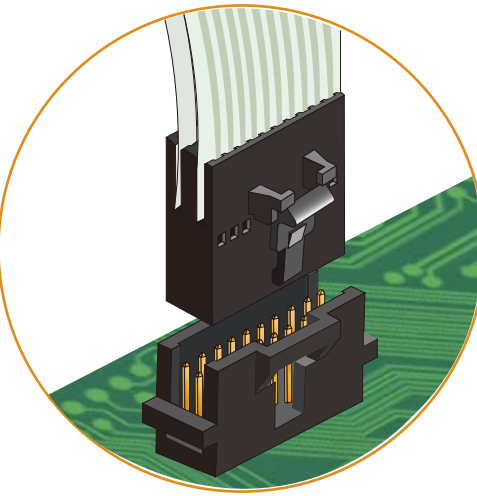

1.27mm

1.27mm

DOUBLE ROW WAFER  
1.27mm PCB

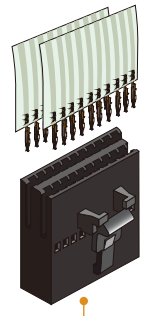

2807-30K-0T(0G)-F

2807HLA-XXDNH (16~100PIN)

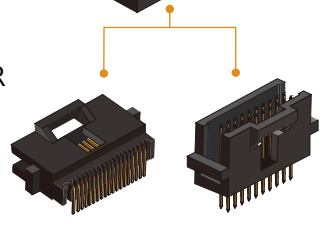

CLSH1.27R-XXDGNN(90° DIP)  
CLSH1.27V-XXDGNN(180° DIP)

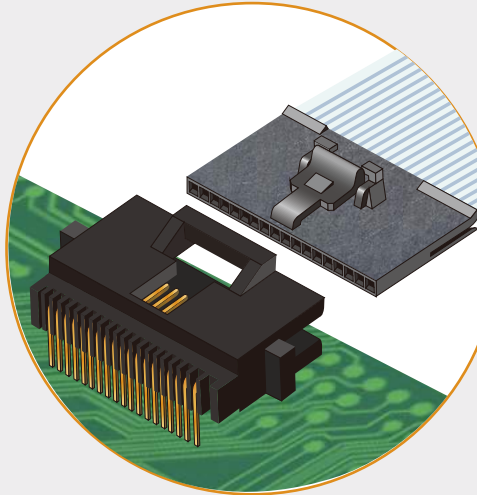

CLSH1.27R-XXGNN  
(90° DIP)

1.27mm

1.27mm

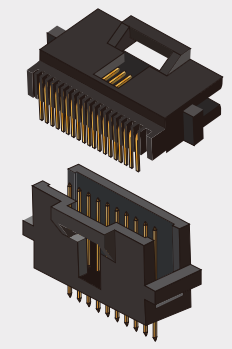

CLSH1.27V-XXGNN  
(180° DIP)

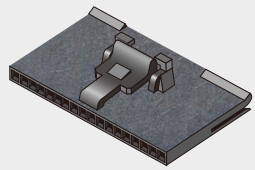

2807HLA-XX  
(04~30PIN)

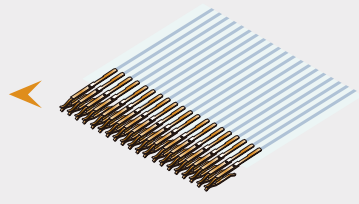

2807-30K-0T(0G)-F

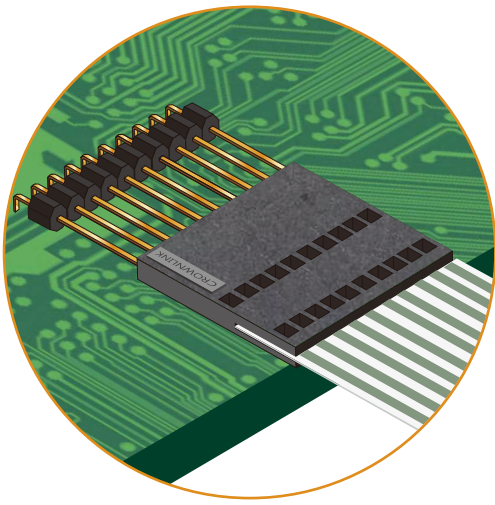

90°  
(DIP)

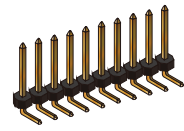

180°  
(DIP)

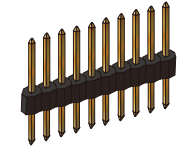

(SMT)

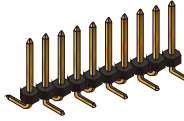

1.27mm

1.27mm

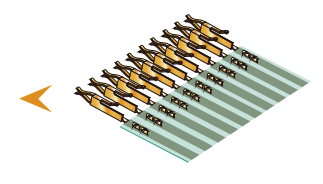
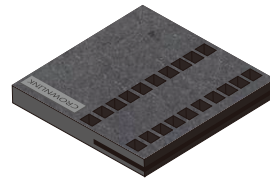

2807H-XX  
(02~30PIN)

2807-30K-0T(0G)-F

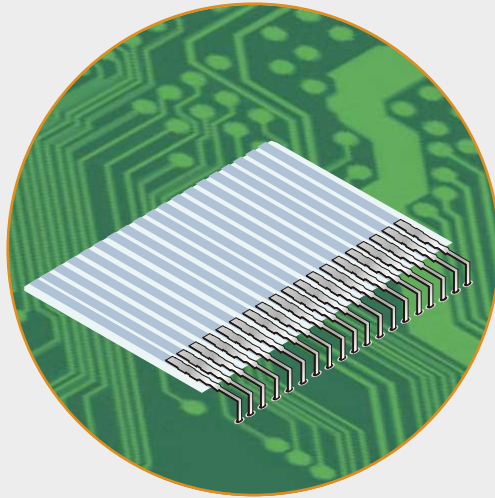

1.27mm

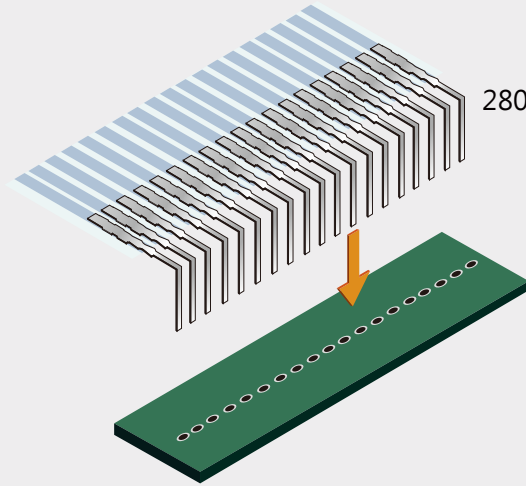

2807-30K-0T(0G)-MH

1.27mm PCB

90°DIP

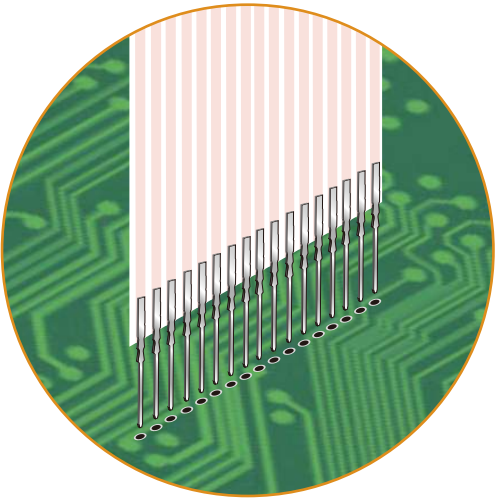

1.27mm

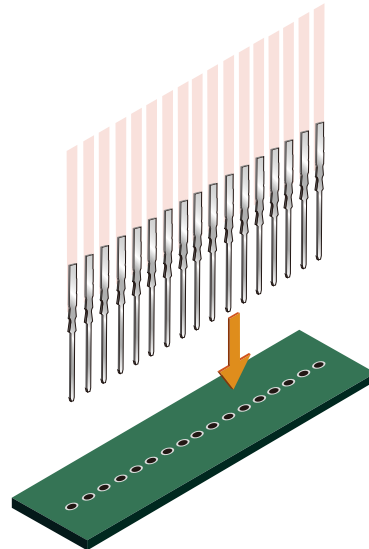

2807-30K-0T(0G)-MH

1.27mm PCB

180°DIP

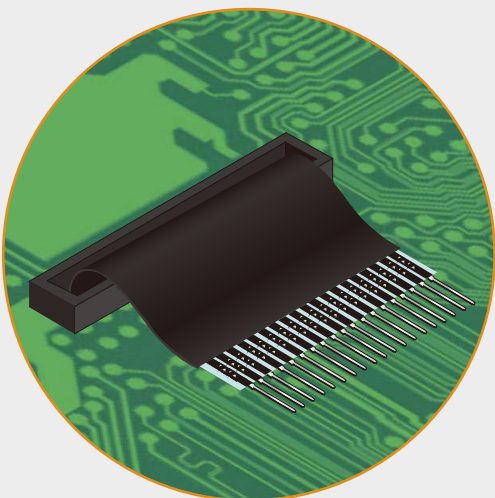

1.27mm

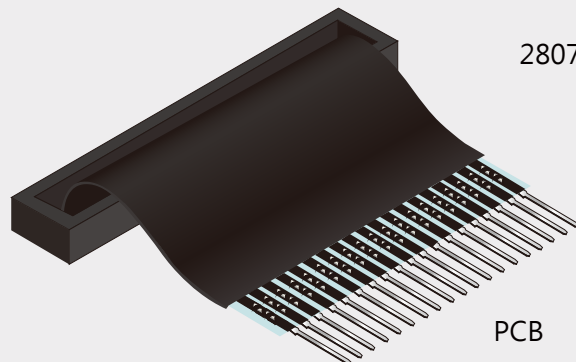

2807-30K-0T(0G)-MH

PCB



# 2.54mm Pitch

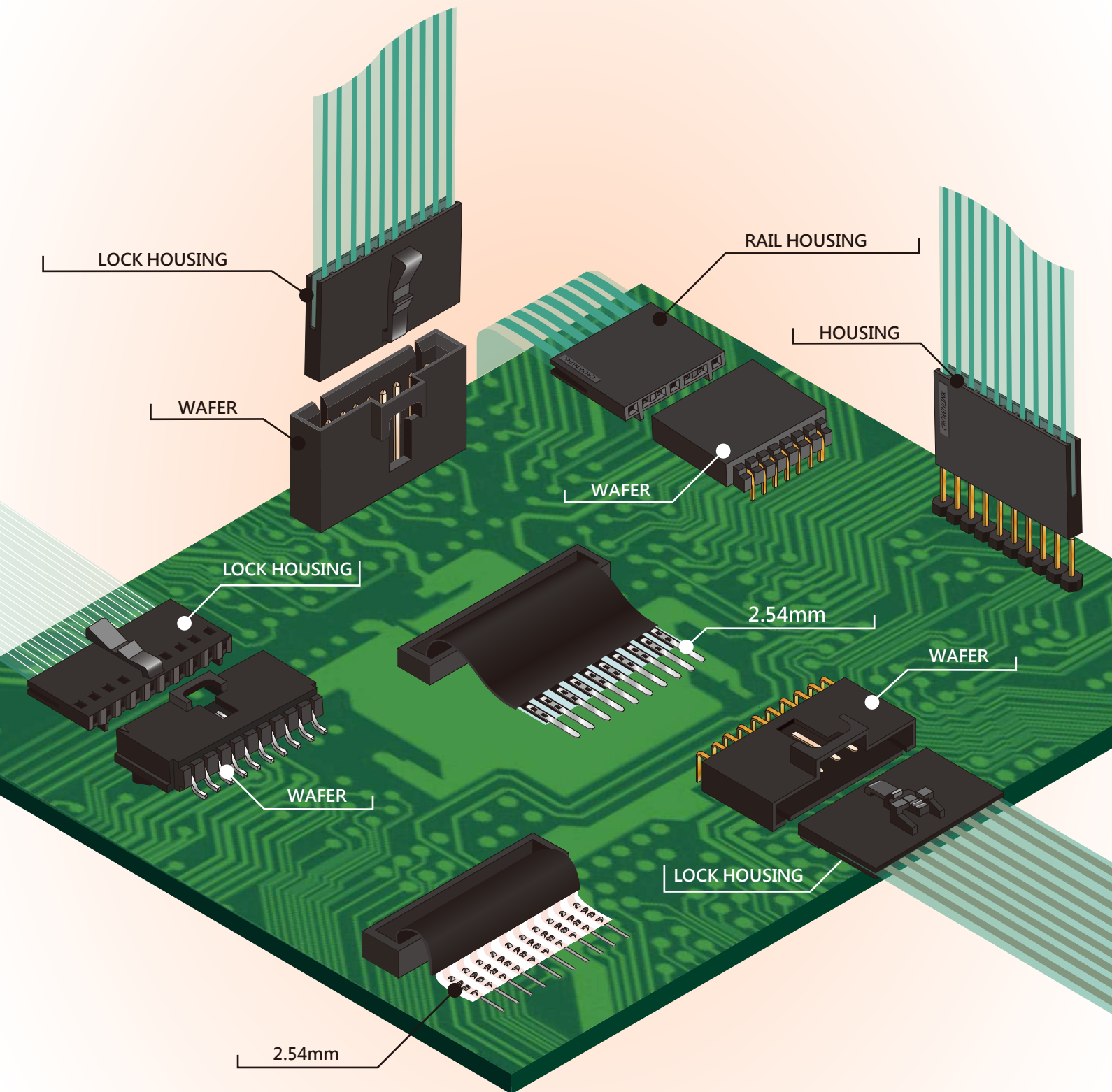

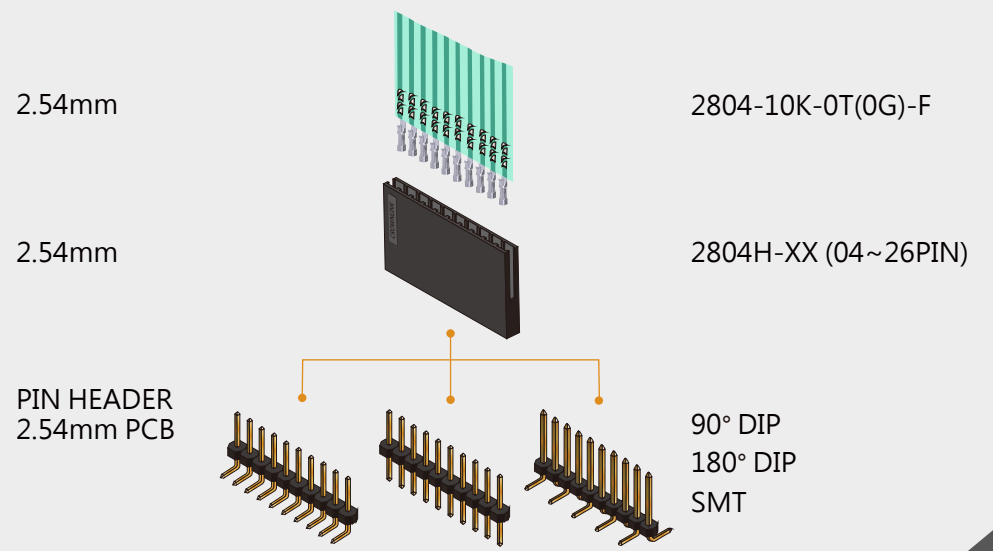
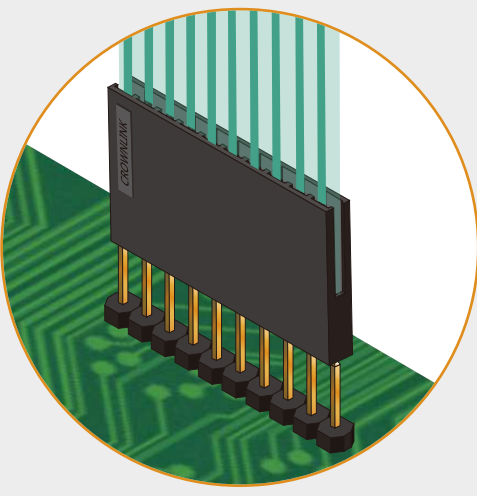
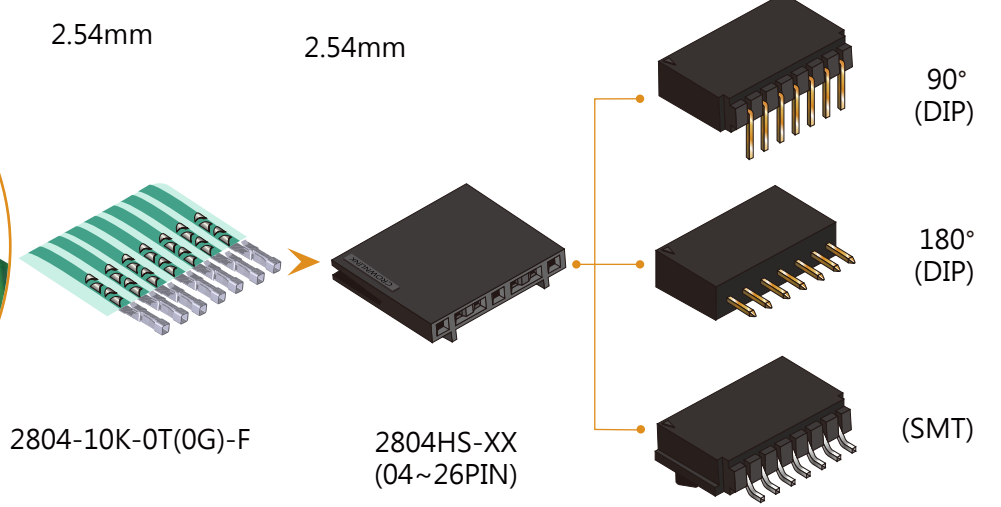
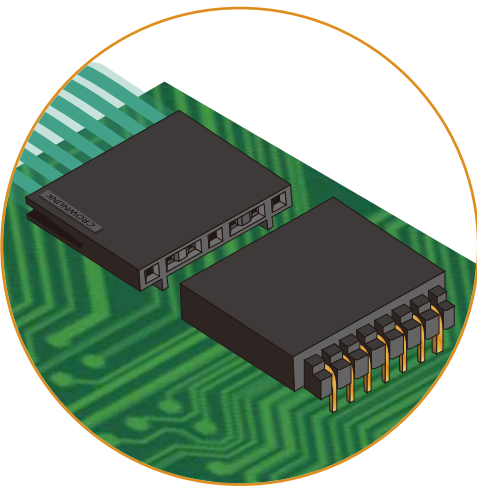
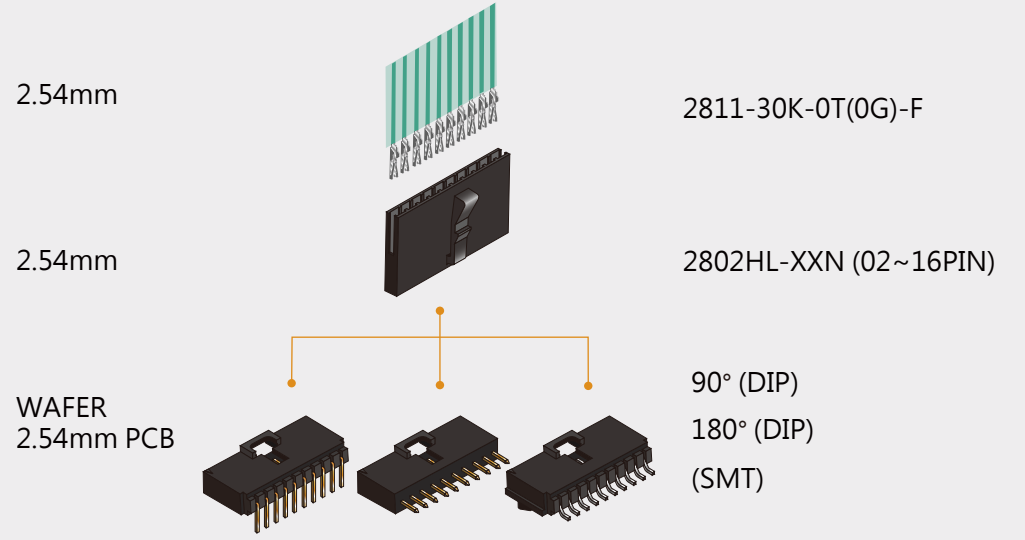
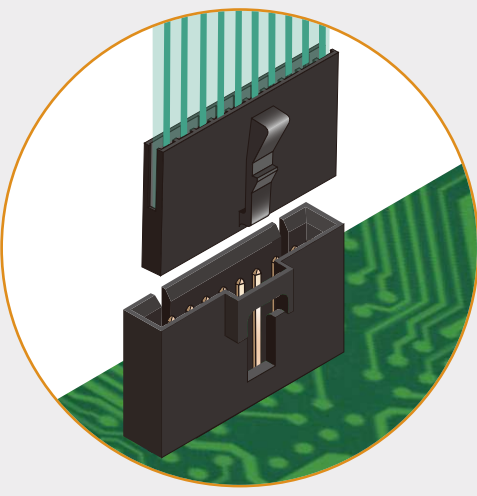
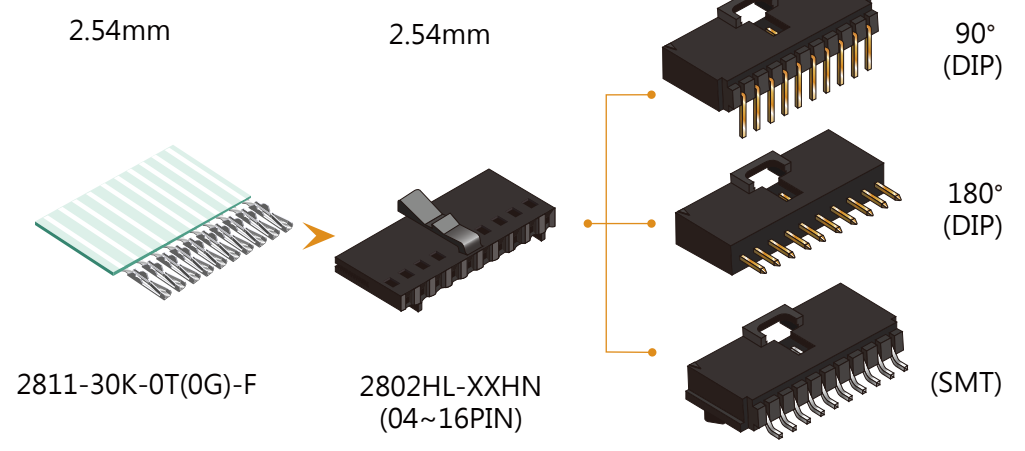
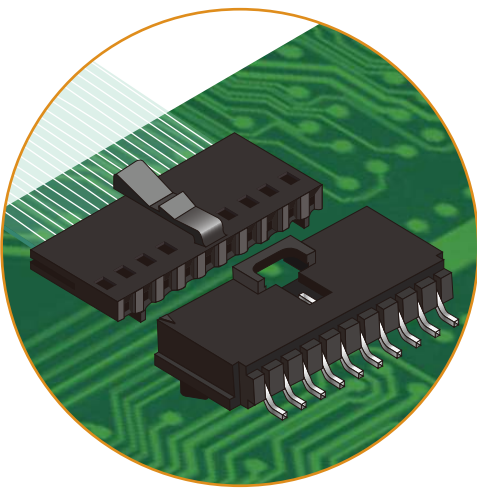

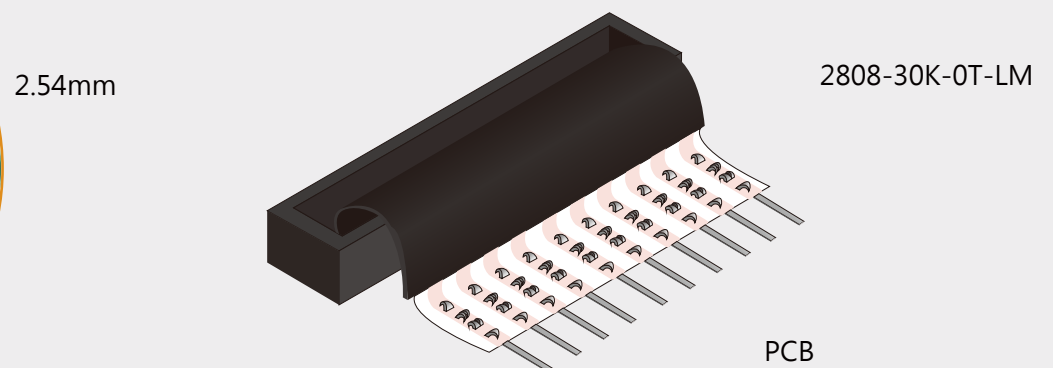
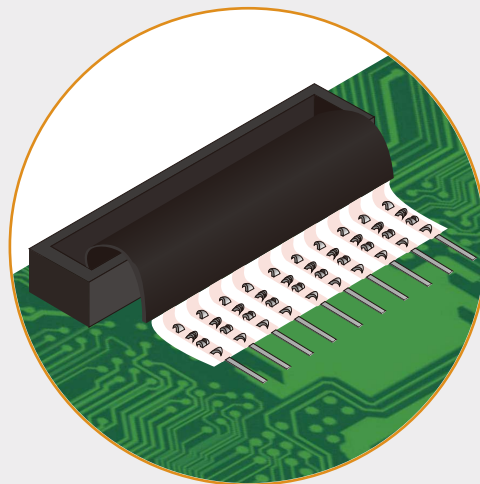
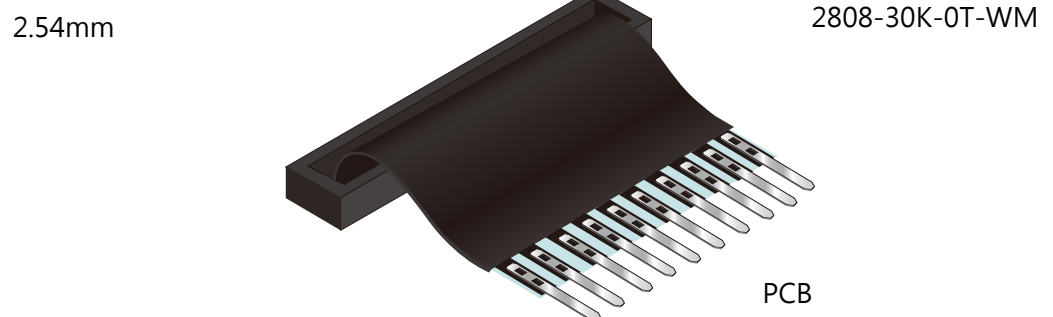
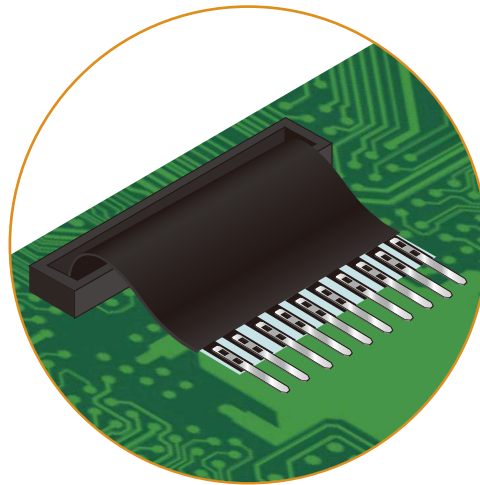
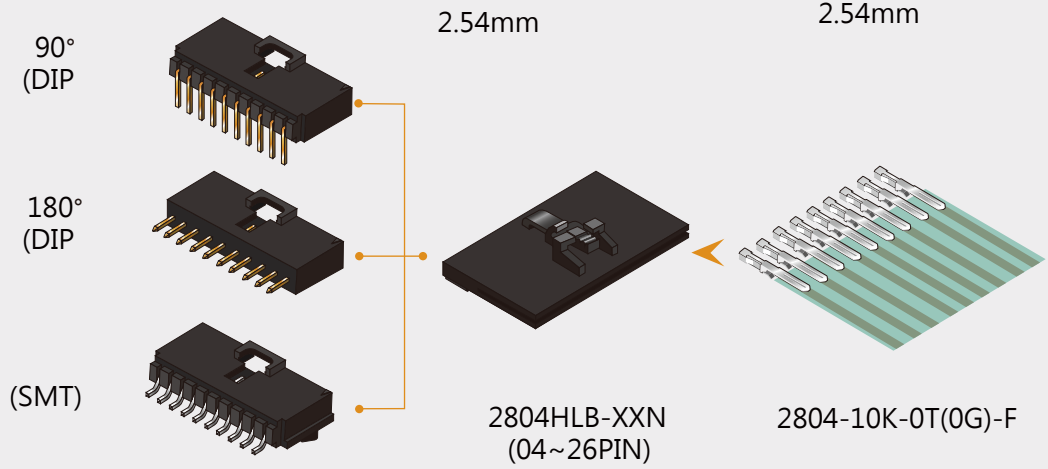
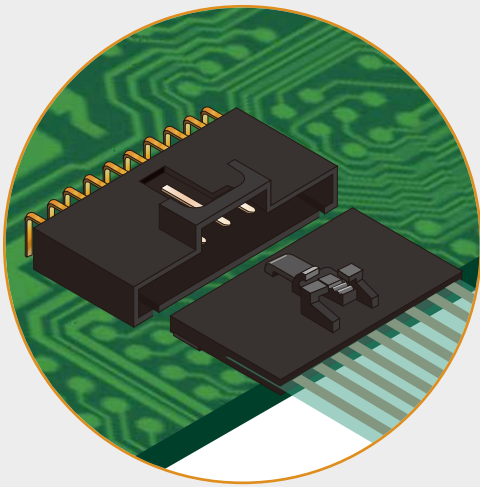



# 2.54mm Pitch

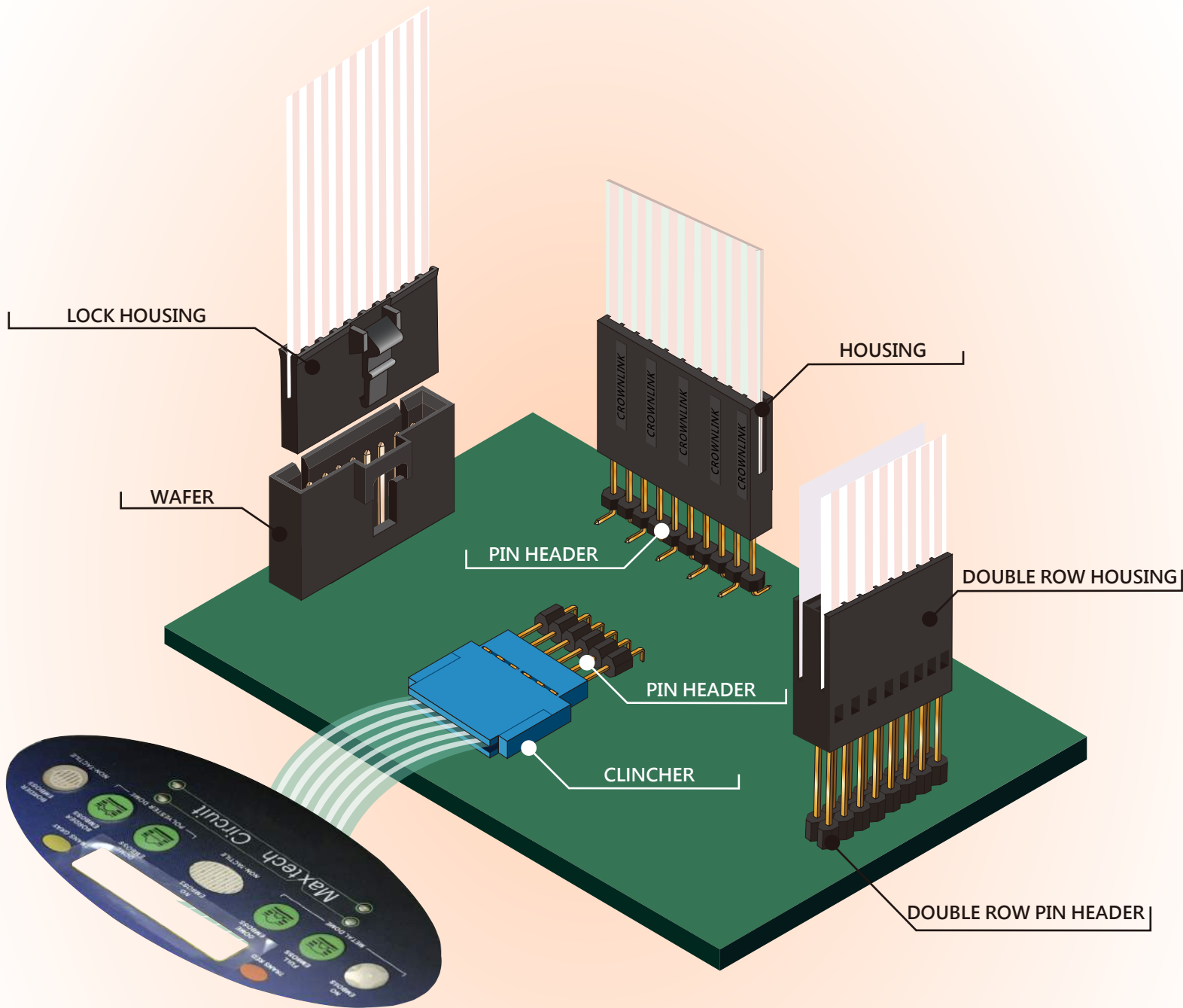

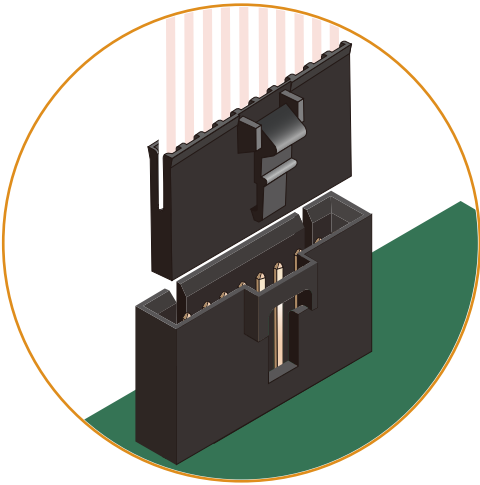

2.54mm

2.54mm

WAFER  
2.54mm PCB

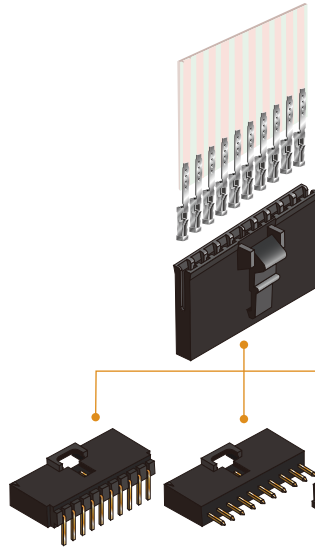

2806P-15K-0T(0G)-FH

2806HLC-XXNH (02~30PIN)

90° DIP  
180° DIP  
SMT

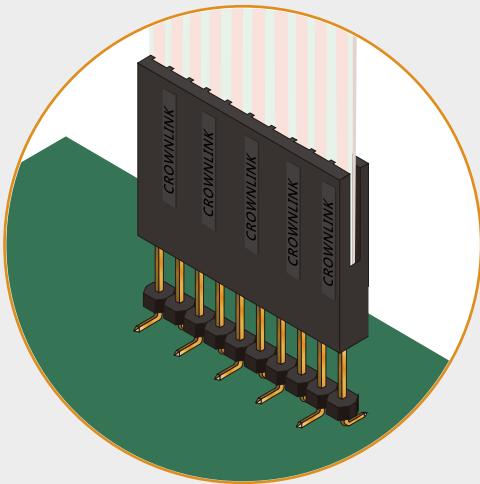

2.54mm

2.54mm

PIN HEADER  
2.54mm PCB

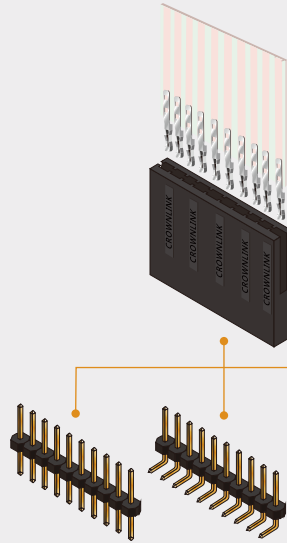

2802-30K-0T(0G)-  
F2808-30K-0T(0G)-F  
2811-30K-0T(0G)-F

2802H-XX (02~26PIN)

90° DIP  
180° DIP  
SMT

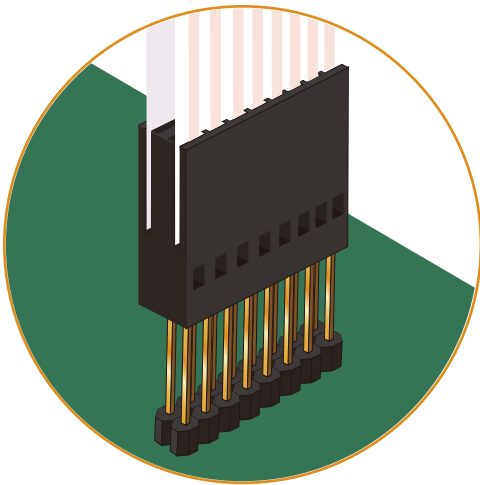

2.54mm

2.54mm

PIN HEADER  
2.54mm PCB

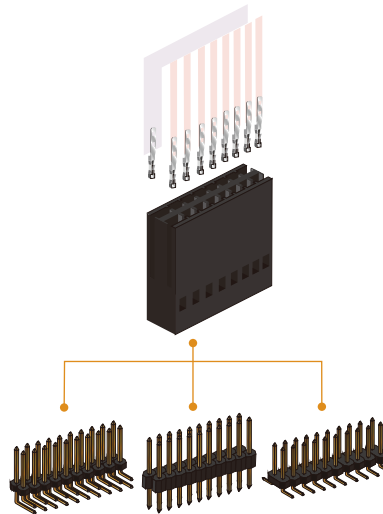

2802-30K-0T(0G)-F

2802H-XXDNS (04~50PIN)

90° DIP  
180° DIP  
SMT

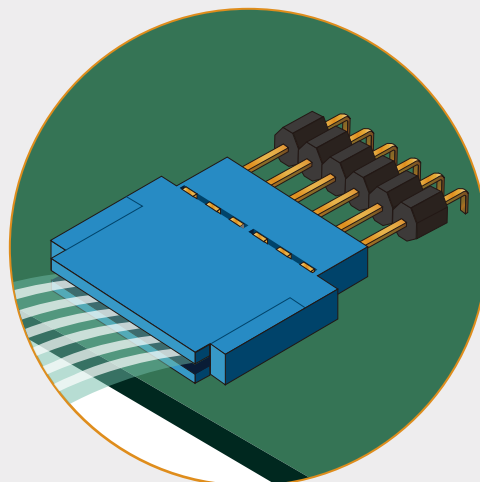

2.54mm

2.54mm

FFC  
FPC

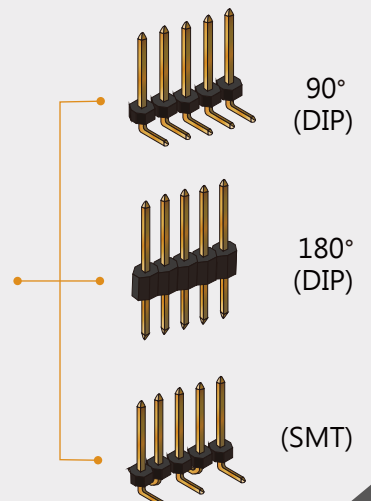

90°  
(DIP)

180°  
(DIP)

(SMT)