



3
YEARS
WARRANTY

ROHS
COMPLIANT

REACH
COMPLIANT



Railway



Automation



Datacom



IPC



Industry



Measurement



Telecom



Automobile



Boat



Charger



Medical



PV



3000
VDC
Isolation
Voltage

12:1
Ultra-Wide
Input
Range

6
sided
Shielding

HOLD
UP

LOW
Standby
Power

NO
Min. Load
Required

REMOTE
ON
OFF

UVP
Adjustable

OCP

OTP

OVP

SCP

UVP

PART NUMBER STRUCTURE

RED40	-	72	S	05	U	-	K	N	HS
Series Name		Input Voltage (VDC)	Output Quantity	Output Voltage (VDC)	Input Range		Bus Options	Remote On/Off Options	Assembly Options
		36: 9~75 72: 14~160	S: Single D: Dual	05: 5 5P1: 5.1 12: 12 15: 15 24: 24 12: ±12 15: ±15	8:1 12:1		□: None K: With Bus V: With UVP adj.	□: Positive logic N: Negative logic	□: None HS: 7G-0110A-F HC1: 7GA0120P01-F; H=0.3" HC2: 7GA0121P01-F; H=0.5" HC3: 7GA0122P01-F; H=0.8"

TECHNICAL SPECIFICATION All specifications are typical at nominal input, full load and 25°C unless otherwise noted

Model Number	Input Range	Output Voltage	Output Current @Full Load	Input Current @No Load	Efficiency	Maximum Capacitor Load
	VDC	VDC	A	mA	%	μF
RED40-36S05U	9 ~ 75	5	8	30	89	12000
RED40-36S5P1U	9 ~ 75	5.1	8	30	89	12000
RED40-36S12U	9 ~ 75	12	3.33	20	90	2000
RED40-36S15U	9 ~ 75	15	2.67	20	90	1300
RED40-36S24U	9 ~ 75	24	1.67	20	90	490
RED40-36D12U	9 ~ 75	±12	±1.67	20	90	±980
RED40-36D15U	9 ~ 75	±15	±1.33	20	90	±630
RED40-72S05U	14 ~ 160	5	8	15	89	12000
RED40-72S5P1U	14 ~ 160	5.1	8	15	89	12000
RED40-72S12U	14 ~ 160	12	3.33	10	90	2000
RED40-72S15U	14 ~ 160	15	2.67	10	90	1300
RED40-72S24U	14 ~ 160	24	1.67	10	90	490
RED40-72D12U	14 ~ 160	±12	±1.67	10	90	±980
RED40-72D15U	14 ~ 160	±15	±1.33	10	90	±630

INPUT SPECIFICATIONS

Parameter	Conditions	Min.	Typ.	Max.	Unit
Operating input voltage range	36Vin(nom) 72Vin(nom)	9 14	36 72	75 160	VDC
Start up voltage	36Vin(nom) 72Vin(nom)			9 14	VDC
Shutdown voltage	36Vin(nom) 72Vin(nom)	7.3 10	7.7 11	8.1 12	VDC
Start up time	Constant resistive load Power up Remote ON/OFF		60 60	90 90	ms
Input surge voltage	1 second, max. 36Vin(nom) 72Vin(nom)			100 200	VDC
Input filter			Pi type		
Remote ON/OFF (Option)	Referred to - Vin pin Positive logic DC-DC ON (Standard) Negative logic DC-DC ON (Option) DC-DC OFF DC-DC OFF Input current of Ctrl pin Remote off input current	-0.5	3	0.5	mA mA

OUTPUT SPECIFICATIONS							
Parameter	Conditions			Min.	Typ.	Max.	Unit
Voltage accuracy				-1.0		+1.0	%
Line regulation	Low Line to High Line at Full Load			-0.2		+0.2	%
Load regulation	No Load to Full Load	Single		-0.5		+0.5	%
		Dual		-1.0		+1.0	
Cross regulation	Asymmetrical load 25%/100% FL	Dual		-5.0		+5.0	%
Voltage adjustability	Single output	Other		-10		+10	%
		15Vout, 24Vout		-10		+20	
Ripple and noise	Measured by 20MHz bandwidth With a 22uF/25V/X7R MLCC With a 1uF/50V/X7R MLCC	5Vout, 5.1Vout			75	100	mVp-p
		12Vout, 15Vout,			100	125	
		24Vout			150	200	
Temperature coefficient				-0.02		+0.02	%/°C
Transient response recovery time	25% load step change				250		µs
Over voltage protection	Zener diode clamp	5Vout			6.2		VDC
		12Vout			15		
		15Vout			20		
		24Vout			30		
Over load protection	% of Iout rated; Hiccup mode				160		%
Short circuit protection							Continuous, automatic recovery

GENERAL SPECIFICATIONS							
Parameter	Conditions			Min.	Typ.	Max.	Unit
Isolation voltage	1 minute	Input to Output		3000			VDC
		Input (Output) to Case		2250			
Isolation resistance	500VDC			1			GΩ
Isolation capacitance						1500	pF
Switching frequency		5Vout, 5.1Vout		180	200	220	kHz
		Others		144	160	176	
Safety approvals(Pending)							IEC /EN/ UL62368-1
Standard approvals(Pending)							EN50155 EN45545-2
Case material							Copper
Base material							FR4 PCB
Potting material							Silicone (UL94 V-0)
Weight							35g (1.2oz)
MTBF	MIL-HDBK-217F, Full load						6.898 x 10 ⁵ hrs

ENVIRONMENTAL SPECIFICATIONS							
Parameter	Conditions			Min.	Typ.	Max.	Unit
Operating ambient temperature	With derating			-40		+105	°C
Maximum case temperature						105	°C
Over temperature protection					115		°C
Storage temperature range				-55		+125	°C
Thermal impedance	Natural convection	Without Heat-sink			10.8		°C/W
		With Heat-sink	HC1		9.3		
			HC2		7.7		
			HC3、HS		6.2		
Thermal shock							MIL-STD-810F
Shock							EN61373, MIL-STD-810F
Vibration							EN61373, MIL-STD-810F
Relative humidity							5% to 95% RH

EMC SPECIFICATIONS		
Parameter	Conditions	Level
EMI	EN55032,EN50121-3-2	With external components
EMS	EN55035,EN50121-3-2	
ESD	EN61000-4-2	Air $\pm 8\text{kV}$ and Contact $\pm 6\text{kV}$
Radiated immunity	EN61000-4-3	20V/m
Fast transient	EN61000-4-4	$\pm 2\text{kV}$
	RED40-36□□□□U	With 2 pcs of aluminum electrolytic capacitor (Nippon Chemi-con KZN series, 220 μF /100V) and a TVS (SMDJ120A, 120V, 3000Watt peak pulse power) in parallel.
	RED40-72□□□□U	With 2 pcs of aluminum electrolytic capacitor (Nippon Chemi-con KXJ series, 150 μF /200V) and a TVS (SMDJ170A, 170V, 3000Watt peak pulse power) in parallel.
Surge	EN61000-4-5	$\pm 2\text{kV}$
	RED40-36□□□□U	With 2 pcs of aluminum electrolytic capacitor (Nippon Chemi-con KZN series, 220 μF /100V) and a TVS (SMDJ120A, 120V, 3000Watt peak pulse power) in parallel.
	RED40-72□□□□U	With 2 pcs of aluminum electrolytic capacitor (Nippon Chemi-con KXJ series, 150 μF /200V) and a TVS(SMDJ170A, 170V, 3000Watt peak pulse power) in parallel.
Conducted immunity	EN61000-4-6	10Vr.m.s
Power frequency magnetic field	EN61000-4-8	100A/m continuous; 1000A/m 1 second

CHARACTERISTIC CURVE

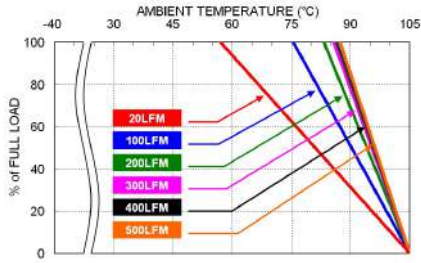

RED40-72S12U Derating Curve

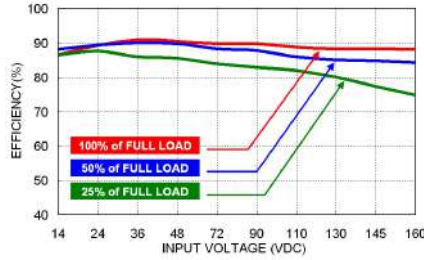

RED40-72S12U Efficiency vs. Input Voltage

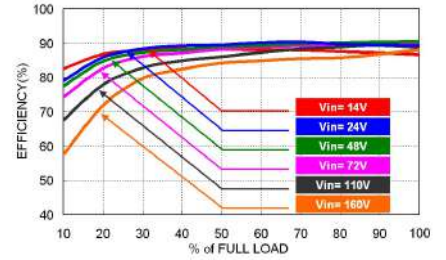

RED40-72S12U Efficiency vs. Output Load

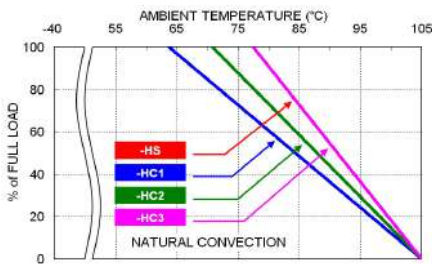

RED40-72S12U Derating Curve With Heat-sink

FUSE CONSIDERATION

This power module is not internally fused. An input line fuse must always be used. This encapsulated power module can be used in a wide variety of applications, ranging from simple stand-alone operation to an integrated part of sophisticated power architecture. To maximum flexibility, internal fusing is not included; however, to achieve maximum safety and system protection, always use an input line fuse. The input line fuse suggest as below :

Model	Fuse Rating (A)	Fuse Type
RED40-36□□□U	8	Fast-Acting
RED40-72□□□U	5	Slow-Blow

The table based on the information provided in this data sheet on inrush energy and maximum DC input current at low Vin.

MECHANICAL DRAWING

Standard、-HC1、-HC2、-HC3

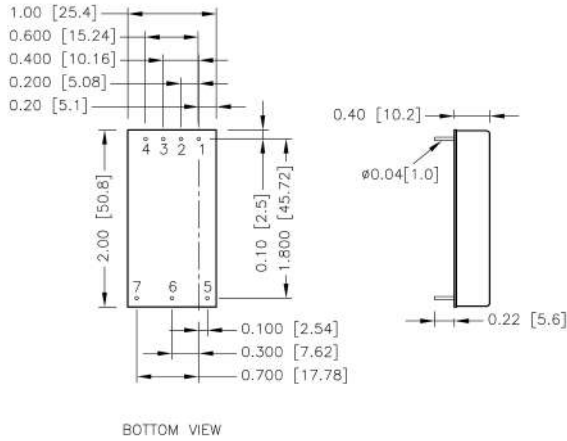

PIN CONNECTION

PIN	SINGLE	DUAL
1	+ Vin	+ Vin
2	- Vin	- Vin
3	NO PIN/BUS/UVP	NO PIN/BUS/UVP
4	Ctrl	Ctrl
5	+ Vout	+ Vout
6	- Vout	Com
7	Trim	- Vout

- * The position of Pin 3 is tentative.
 Pin3 is "Bus" when choosing Bus option (-□K□)
 Pin3 is "UVP" when choosing UVP adj option (-□V□)

- All dimensions in inch [mm]
 Tolerance :x.xx±0.02 [x.x±0.5]
 x.xxx±0.010 [x.xx±0.25]
- Pin dimension tolerance ±0.004[0.10]

-HS

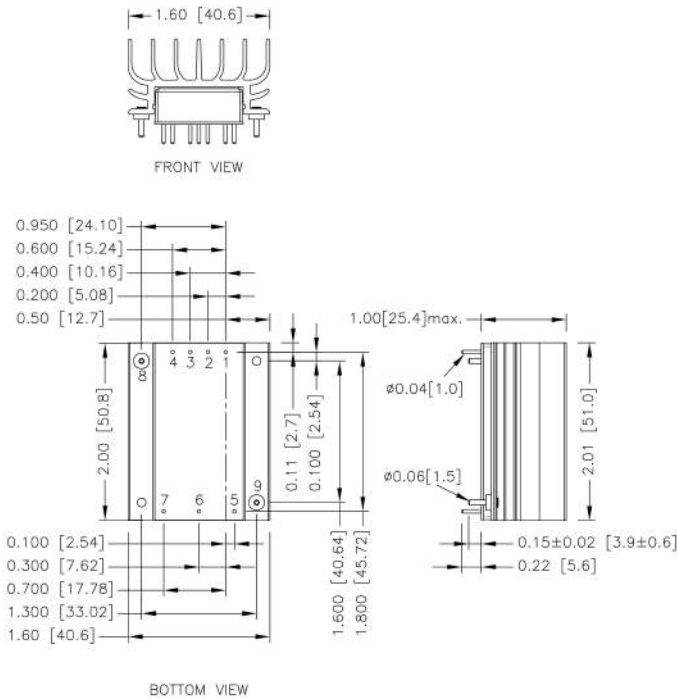

PIN CONNECTION

PIN	SINGLE	DUAL
1	+ Vin	+ Vin
2	- Vin	- Vin
3	NO PIN/BUS/UVP	NO PIN/BUS/UVP
4	Ctrl	Ctrl
5	+ Vout	+ Vout
6	- Vout	Com
7	Trim	- Vout
8	Heat-sink	Heat-sink
9	Heat-sink	Heat-sink

- * The position of Pin 3 is tentative.
 Pin3 is "Bus" when choosing Bus option (-□K□)
 Pin3 is "UVP" when choosing UVP adj option (-□V□)

- All dimensions in inch [mm]
 Tolerance :x.xx±0.02 [x.x±0.5]
 x.xxx±0.010 [x.xx±0.25]
- Pin dimension tolerance ±0.004[0.10]

RECOMMENDED PAD LAYOUT

Standard

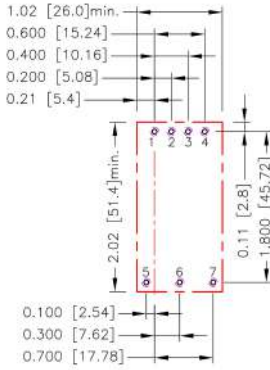

All dimensions in inch[mm]
 Pad size(lead free recommended)
 Through hole 1.2.3.4.5.6.7:Ø0.051[1.30]
 Top view pad 1.2.3.4.5.6.7:Ø0.064[1.63]
 Bottom view pad 1.2.3.4.5.6.7:Ø0.102[2.60]

-HS

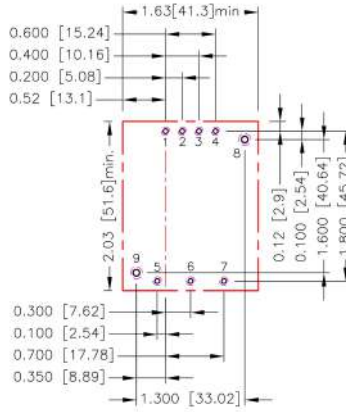

All dimensions in inch[mm]
 Pad size(lead free recommended)
 Through hole 1.2.3.4.5.6.7:Ø0.051[1.30]
 8.9:Ø0.071[1.80]
 Top view pad 1.2.3.4.5.6.7:Ø0.064[1.63]
 8.9:Ø0.089[2.25]
 Bottom view pad 1.2.3.4.5.6.7:Ø0.102[2.60]
 8.9:Ø0.142[3.60]

-HC1、-HC2、-HC3

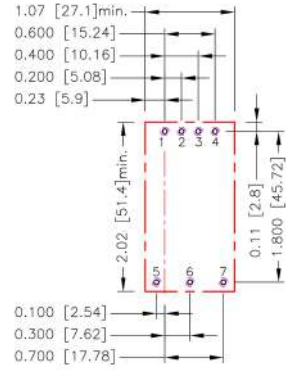

All dimensions in inch[mm]
 Pad size(lead free recommended)
 Through hole 1.2.3.4.5.6.7:Ø0.051[1.30]
 Top view pad 1.2.3.4.5.6.7:Ø0.064[1.63]
 Bottom view pad 1.2.3.4.5.6.7:Ø0.102[2.60]

THERMAL CONSIDERATIONS

The power module operates in a variety of thermal environments. However, sufficient cooling should be provided to help ensure reliable operation of the unit. Heat is removed by conduction, convection, and radiation to the surrounding environment. Proper cooling can be verified by measuring the point as the figure below. The temperature at this location should not exceed "Maximum case temperature". When operating, adequate cooling must be provided to maintain the test point temperature at or below "Maximum case temperature". You can limit this temperature to a lower value for extremely high reliability.

- Thermal test condition with vertical direction by natural convection (20LFM).

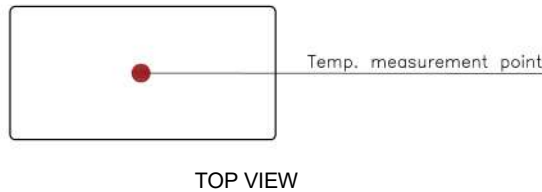

HEAT-SINK TYPE OPTIONS

RED40-□□□□□□U-HS
7G-0110A-F

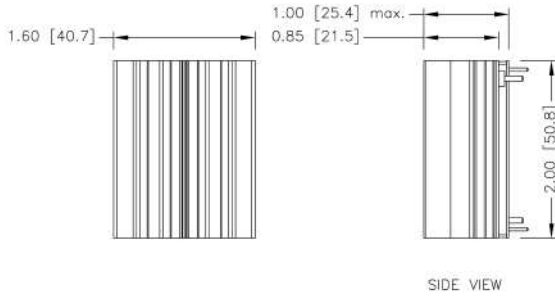

RED40-□□□□□□U-HC1
7GA0120P01-F

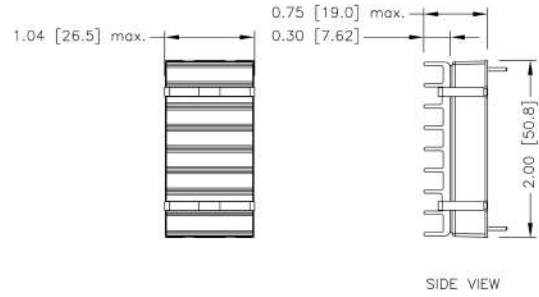

RED40-□□□□□□U-HC2
7GA0121P01-F

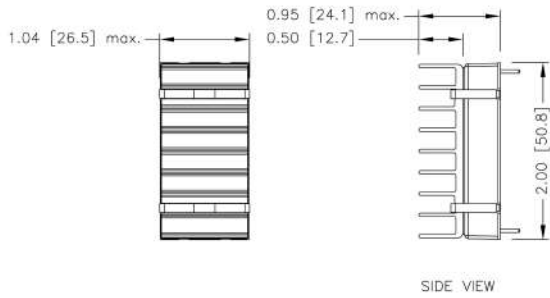

RED40-□□□□□□U-HC3
7GA0122P01-F

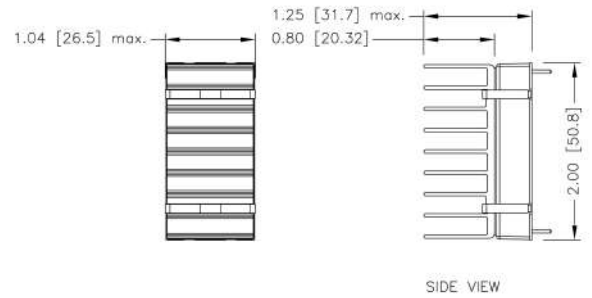

1. All dimensions in inch [mm]
2. Tolerance :x.xx±0.02 [x.x±0.5]
x.xxx±0.010 [x.xx±0.25]

TYPICAL APPLICATION

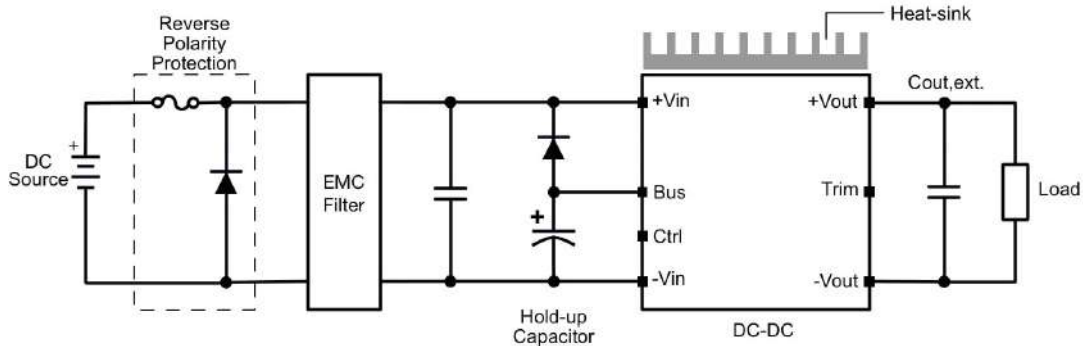

Typical Connection

UVLO

This series product has ultra wide input range. It could cover many kind of nominal input voltage in one module. In order to preventing incorrect operating under different input system, it offers UVLO adjustment by connecting a resistor to set UVLO threshold.

UVLO Constants

Model	A	B	C
RED40-36□□□U	14804	144000	16500
RED40-72□□□U	22330	321000	24000

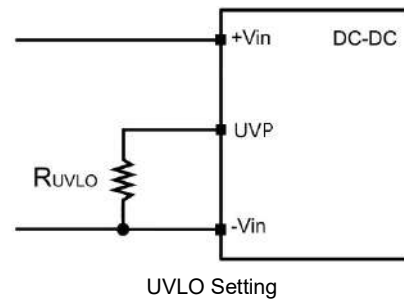

UVLO Setting

UVLO Equation

Start-up Voltage

$$V_{\text{start-up}} = \left(0.8 + \frac{A \times R_{\text{UVLO}}}{A + R_{\text{UVLO}}} \times 5 \times 10^{-6} \right) \times \left(1 + B \times \frac{C + R_{\text{UVLO}}}{C \times R_{\text{UVLO}}} \right)$$

Shutdown Voltage

$$V_{\text{shutdown}} = 0.785 \times \left(1 + B \times \frac{R_{\text{UVLO}} + C}{R_{\text{UVLO}} \times C} \right)$$

UVLO values for various nominal input voltage and R_{UVLO} table

RED40-36□□□U				
Nominal Vin	12 V	24 V	36 V	48 V
Start-up voltage	8.5 V	14.8 V	22.0 V	29.2 V
Shutdown voltage	7.6 V	13.8 V	20.9 V	28.0 V
UVLO Setting resistor	OPEN	18.3 KΩ	8.54 KΩ	5.57 KΩ

RED40-72□□□U						
Nominal Vin	24 V	36 V	48 V	72 V	96 V	110 V
Start-up voltage	14.8 V	22 V	29.2 V	43.6 V	58.0 V	66.4 V
Shutdown voltage	13.0 V	20.0V	27.1 V	41.2 V	55.3 V	63.6 V
UVLO Setting resistor	151.5 KΩ	28.87 KΩ	15.95 KΩ	8.42 KΩ	5.72 KΩ	4.82 KΩ

Hold Up Time

Generally, connecting a large number of hold up capacitors on input are necessary to get a long duration of hold up time for S2, C2 described in EN50155. The Bus pin features excellent function can simply connect capacitors to Bus pin with less quantity of capacitors. It helps reduce layout area and smooth the inrush current.

For further information, please contact P-DUKE.

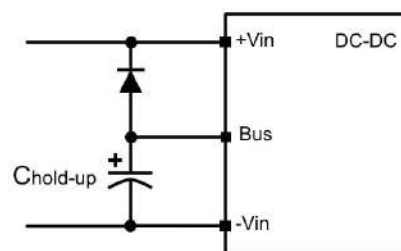

Hold Up Function

OUTPUT VOLTAGE ADJUSTMENT

It allows the user to increase or decrease the output voltage of the module.
 This is accomplished by connecting an external resistor between the Trim pin and either the +Vout or -Vout pins.
 With an external resistor between the Trim and -Vout pin, the output voltage increases.
 With an external resistor between the Trim and +Vout pin, the output voltage decreases.
 The external Trim resistor needs to be at least 1/8W of rated power.

EXTERNAL OUTPUT TRIMMING

Output can be externally trimmed by using the method shown below.

Trim-up

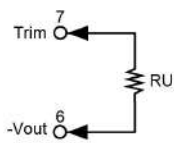

□□S05U

ΔV (%)	1	2	3	4	5	6	7	8	9	10
Vout (V)	5.05	5.10	5.15	5.20	5.25	5.30	5.35	5.40	5.45	5.50
RU (k Ω)	35.360	16.244	9.752	6.483	4.514	3.198	2.257	1.550	1.000	0.559

□□S5P1U

ΔV (%)	1	2	3	4	5	6	7	8	9	10
Vout (V)	5.15	5.20	5.25	5.30	5.35	5.40	5.45	5.50	5.55	5.61
RU (k Ω)	37.123	16.889	10.128	6.745	4.714	3.359	2.392	1.666	1.101	0.649

□□S12U

ΔV (%)	1	2	3	4	5	6	7	8	9	10
Vout (V)	12.12	12.24	12.36	12.48	12.60	12.72	12.84	12.96	13.08	13.20
RU (k Ω)	392.864	172.175	101.446	66.591	45.837	32.068	22.264	14.929	9.234	4.685

□□S15U

ΔV (%)	1	2	3	4	5	6	7	8	9	10
Vout (V)	15.15	15.30	15.45	15.60	15.75	15.90	16.05	16.20	16.35	16.50
RU (k Ω)	413.163	198.115	125.754	89.445	67.618	53.050	42.636	34.820	28.739	23.872
ΔV (%)	11	12	13	14	15	16	17	18	19	20
Vout (V)	16.65	16.80	16.95	17.10	17.25	17.40	17.55	17.70	17.85	18.00
RU (k Ω)	19.888	16.568	13.759	11.350	9.262	7.434	5.822	4.389	3.106	1.951

□□S24U

ΔV (%)	1	2	3	4	5	6	7	8	9	10
Vout (V)	24.24	24.48	24.72	24.96	25.20	25.44	25.68	25.92	26.16	26.40
RU (k Ω)	947.146	472.772	303.499	216.605	163.724	128.153	102.589	83.329	68.298	56.240
ΔV (%)	11	12	13	14	15	16	17	18	19	20
Vout (V)	26.64	26.88	27.12	27.36	27.60	27.84	28.08	28.32	28.56	28.80
RU (k Ω)	46.353	38.099	31.104	25.101	19.892	15.330	11.302	7.718	4.509	1.619

OUTPUT VOLTAGE ADJUSTMENT(CONTINUED)

Trim-down

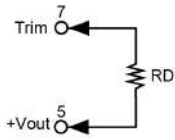

□□S05U

ΔV (%)	1	2	3	4	5	6	7	8	9	10
Vout (V)	4.95	4.90	4.85	4.80	4.75	4.70	4.65	4.60	4.55	4.50
RD (k Ω)	46.686	20.817	12.360	8.162	5.653	3.984	2.794	1.903	1.210	0.656

□□S5P1U

ΔV (%)	1	2	3	4	5	6	7	8	9	10
Vout (V)	5.04	4.99	4.94	4.89	4.84	4.79	4.74	4.69	4.64	4.59
RD (k Ω)	48.513	22.079	13.268	8.862	6.219	4.456	3.198	2.253	1.519	0.932

□□S12U

ΔV (%)	1	2	3	4	5	6	7	8	9	10
Vout (V)	11.88	11.76	11.64	11.52	11.40	11.28	11.16	11.04	10.92	10.80
RD (k Ω)	435.294	201.116	120.429	79.573	54.894	38.371	26.535	17.639	10.709	5.157

□□S15U

ΔV (%)	1	2	3	4	5	6	7	8	9	10
Vout (V)	14.85	14.70	14.55	14.40	14.25	14.10	13.95	13.80	13.65	13.50
RD (k Ω)	302.154	132.978	78.547	51.685	35.680	25.055	17.489	11.826	7.429	3.916

□□S24U

ΔV (%)	1	2	3	4	5	6	7	8	9	10
Vout (V)	23.76	23.52	23.28	23.04	22.80	22.56	22.32	22.08	21.84	21.60
RD (k Ω)	736.063	326.672	192.473	125.790	85.913	59.383	40.459	26.282	15.263	6.454